



# BGM1013

MMIC wideband amplifier

Rev. 5 — 19 September 2011

Product data sheet

## 1. Product profile

### 1.1 General description

Silicon Monolithic Microwave Integrated Circuit (MMIC) wideband amplifier with internal matching circuit in a 6-pin SOT363 SMD plastic package.

#### CAUTION



This device is sensitive to ElectroStatic Discharge (ESD). Therefore care should be taken during transport and handling.

### 1.2 Features and benefits

- Internally matched to 50  $\Omega$
- Good output match to 75  $\Omega$
- Very high gain; 35.5 dB at 1 GHz
- Upper corner frequency at 2.1 GHz
- 31 dB flat gain up to 2.2 GHz application
- 14 dBm saturated output power at 1 GHz
- High linearity (23 dBm IP<sub>3out</sub> and 43 dBc IM2)
- 40 dB isolation.

### 1.3 Applications

- Low Noise Block (LNB) Intermediate Frequency (IF) amplifiers
- Cable systems
- General purpose.

### 1.4 Quick reference data

Table 1. Quick reference data

Symbol	Parameter	Conditions	Min	Typ	Max	Unit
V <sub>S</sub>	DC supply voltage	RF input; AC coupled	-	5	6	V
I <sub>S</sub>	DC supply current		23	27.5	33	mA
S <sub>21</sub>   <sup>2</sup>	insertion power gain	f = 1 GHz	34.5	35.5	36.2	dB
NF	noise figure	f = 1 GHz	-	4.6	4.7	dB
P <sub>L(sat)</sub>	saturated load power	f = 1 GHz	13.0	14.0	-	dBm



## 2. Pinning information

**Table 2. Pinning**

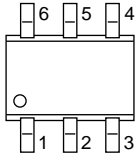
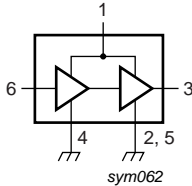
Pin	Description	Simplified outline	Symbol
1	V <sub>S</sub>		 sym062
2, 5	GND2		
3	RF_OUT		
4	GND1		
6	RF_IN		

## 3. Ordering information

**Table 3. Ordering information**

Type number	Package		
	Name	Description	Version
BGM1013	SC-88	plastic surface mounted package; 6 leads	SOT363

## 4. Marking

**Table 4. Marking codes**

Type number	Marking code
BGM1013	C4-

## 5. Limiting values

**Table 5. Limiting values**

*In accordance with the Absolute Maximum Rating System (IEC 60134).*

Symbol	Parameter	Conditions	Min	Max	Unit
V <sub>S</sub>	DC supply voltage	RF input; AC coupled	-	6	V
I <sub>S</sub>	DC supply current		-	35	mA
P <sub>tot</sub>	total power dissipation	T <sub>sp</sub> ≤ 90 °C	-	200	mW
T <sub>stg</sub>	storage temperature		-65	+150	°C
T <sub>j</sub>	junction temperature		-	150	°C
P <sub>D</sub>	maximum drive power		-	-10	dBm

## 6. Recommended operating conditions

**Table 6. Operating conditions**

Symbol	Parameter	Conditions	Min	Typ	Max	Unit
$V_S$	supply voltage		4.5	5.0	5.5	V
$T_{amb}$	ambient temperature		-40	25	85	°C

## 7. Thermal characteristics

**Table 7. Thermal characteristics**

Symbol	Parameter	Conditions	Typ	Unit
$R_{th(j-sp)}$	thermal resistance from junction to solder point	$P_{tot} = 200 \text{ mW}$ ; $T_{sp} \leq 90 \text{ °C}$	300	K/W

## 8. Characteristics

**Table 8. Characteristics**

$V_S = 5 \text{ V}$ ;  $I_S = 27.5 \text{ mA}$ ;  $T_j = 25 \text{ °C}$ ; measured on demo board; unless otherwise specified.

Symbol	Parameter	Conditions	Min	Typ	Max	Unit
$V_S$	DC supply voltage	RF input; AC coupled	-	5	6	V
$I_S$	DC supply current		23	27.5	33	mA
$ S_{21} ^2$	insertion power gain	$f = 100 \text{ MHz}$	34.5	35.2	35.9	dB
		$f = 1 \text{ GHz}$	34.5	35.5	36.2	dB
		$f = 1.8 \text{ GHz}$	33.0	34.0	35.2	dB
		$f = 2.2 \text{ GHz}$	30.5	31.8	33.1	dB
		$f = 2.6 \text{ GHz}$	25.2	29.7	31.2	dB
		$f = 3 \text{ GHz}$	24.0	26.1	27.9	dB
$ S_{11} ^2$	input return loss	$f = 1 \text{ GHz}$	10.1	10.6	-	dB
		$f = 2.2 \text{ GHz}$	9.3	10.2	-	dB
$ S_{22} ^2$	output return loss	$Z_L = 50 \text{ } \Omega$				
		$f = 1 \text{ GHz}$	18	20	-	dB
		$f = 2.2 \text{ GHz}$	13	16	-	dB
		$Z_L = 75 \text{ } \Omega$				
		$f = 1 \text{ GHz}$	15	17	-	dB
		$f = 2.2 \text{ GHz}$	12	15	-	dB
$ S_{12} ^2$	isolation	$f = 1 \text{ GHz}$	40	42	-	dB
		$f = 2.2 \text{ GHz}$	34	36	-	dB
NF	noise figure	$f = 1 \text{ GHz}$	-	4.6	4.7	dB
		$f = 2.2 \text{ GHz}$	-	4.9	5.1	dB
B	bandwidth	3 dB below flat gain at $f = 1 \text{ GHz}$	-	2.1	-	GHz
K	stability factor	$f = 1 \text{ GHz}$	1.2	1.3	-	
		$f = 2.2 \text{ GHz}$	0.9	1.0	-	
$P_{L(sat)}$	saturated load power	$f = 1 \text{ GHz}$	13.0	14.0	-	dBm
		$f = 2.2 \text{ GHz}$	9.0	10.2	-	dBm

**Table 8. Characteristics ...continued**

$V_S = 5\text{ V}$ ;  $I_S = 27.5\text{ mA}$ ;  $T_j = 25\text{ }^\circ\text{C}$ ; measured on demo board; unless otherwise specified.

Symbol	Parameter	Conditions	Min	Typ	Max	Unit
$P_{L(1dB)}$	load power at 1 dB gain compression	$f = 1\text{ GHz}$	12.0	13.0	-	dBm
		$f = 2.2\text{ GHz}$	7.0	8.1	-	dBm
$IP3_{in}$	input third order intercept point	$f = 1\text{ GHz}$	-14	-12.8	-	dBm
		$f = 2.2\text{ GHz}$	-15	-13.2	-	dBm
$IP3_{out}$	output third order intercept point	$f = 1\text{ GHz}$	21	22.7	-	dBm
		$f = 2.2\text{ GHz}$	17	18.6	-	dBm
IM2	second order intermodulation product	$f_0 = 1\text{ GHz}$ ; $P_D = -45\text{ dBm}$ ( $P_L = -10\text{ dBm}$ )	-	45	43	dBc
		$f_0 = 1\text{ GHz}$ ; $P_D = -40\text{ dBm}$ ( $P_L = -5\text{ dBm}$ )	-	43	41	dBc

## 9. Application information

Figure 1 shows a typical application circuit for the BGM1013 MMIC. The device is internally matched to  $50\ \Omega$  and therefore does not need any external matching. Output impedance is also very good to  $75\ \Omega$  load. The value of the input and output DC blocking capacitors C1 and C2 should be not more than 100 pF for applications above 100 MHz. Their values can be used to fine-tune the input and output impedance.

For the RF-choke, optimal results are obtained with a good quality chip inductor like the TDK MLG1608 (0603) or a wire-wound SMD. The value of the inductor can be used to fine-tune the output impedance.

The RF choke and supply decoupling components should be located as close as possible to the MMIC.

Ground paths must be as short as possible. The printed-circuit board (PCB) top ground plane must be as close as possible to the MMIC, and ideally directly beneath it. When using vias, use at least 3 vias for the top ground plane in order to limit ground path inductance. Supply decoupling with C3 should be from pin 1 to the same top ground plane.

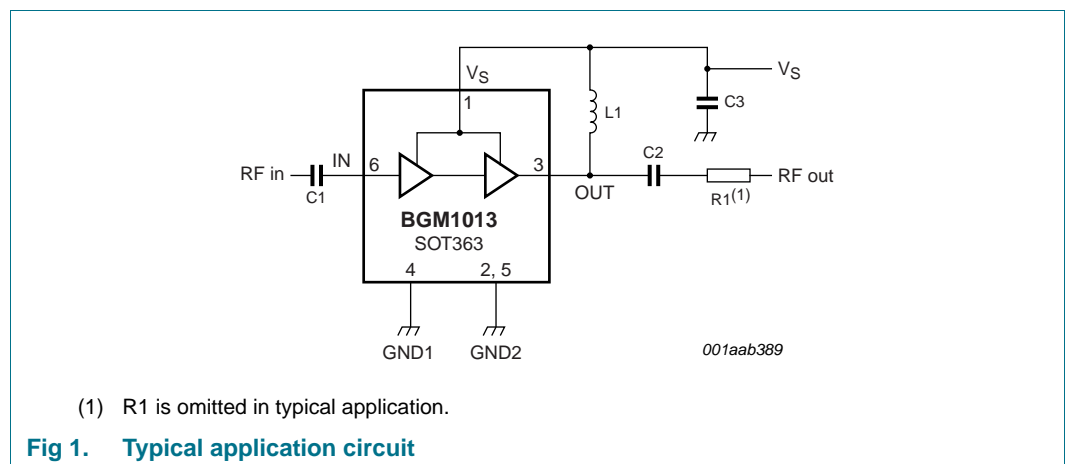
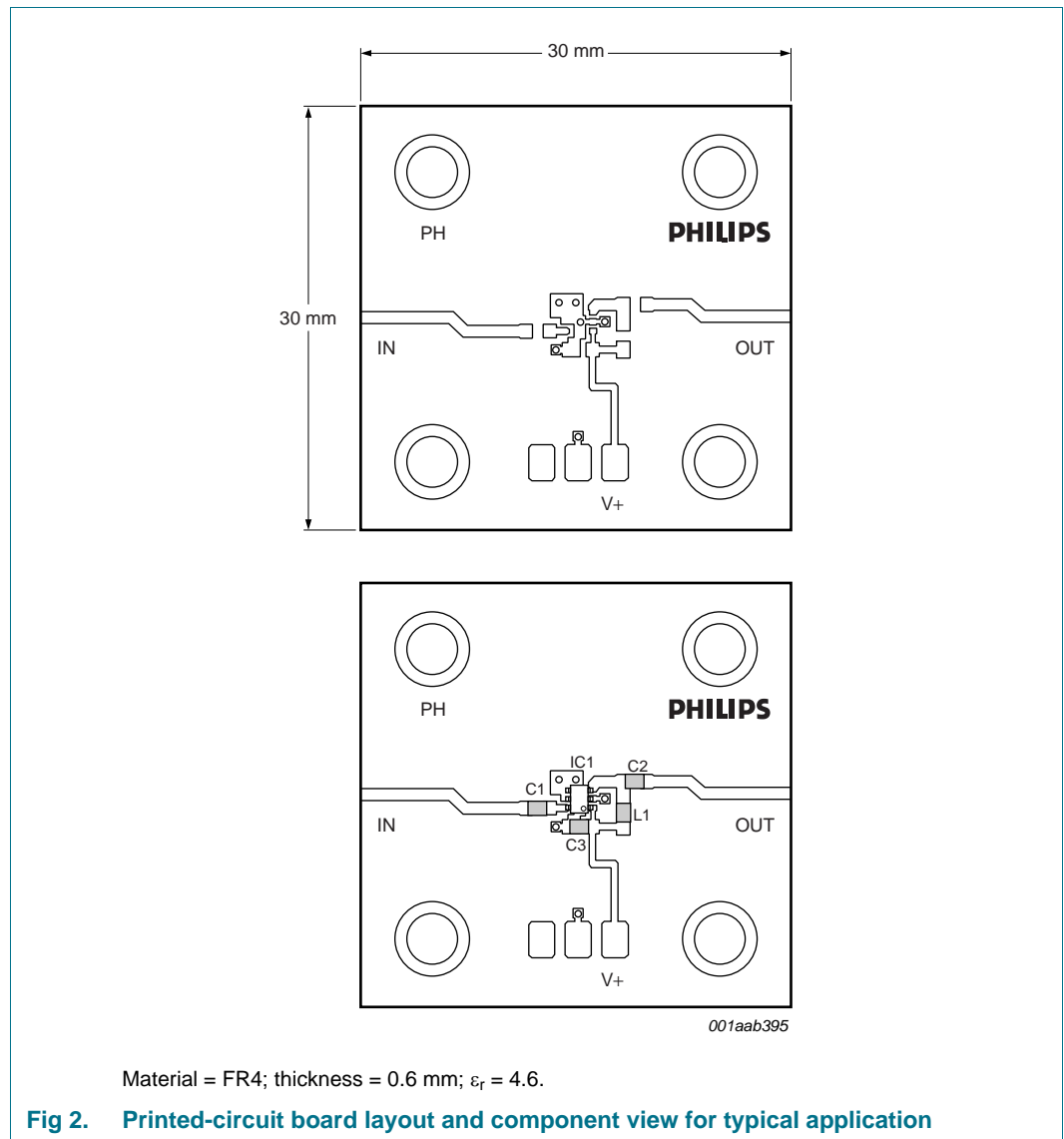

Figure 2 shows the PCB layout used for the typical application.

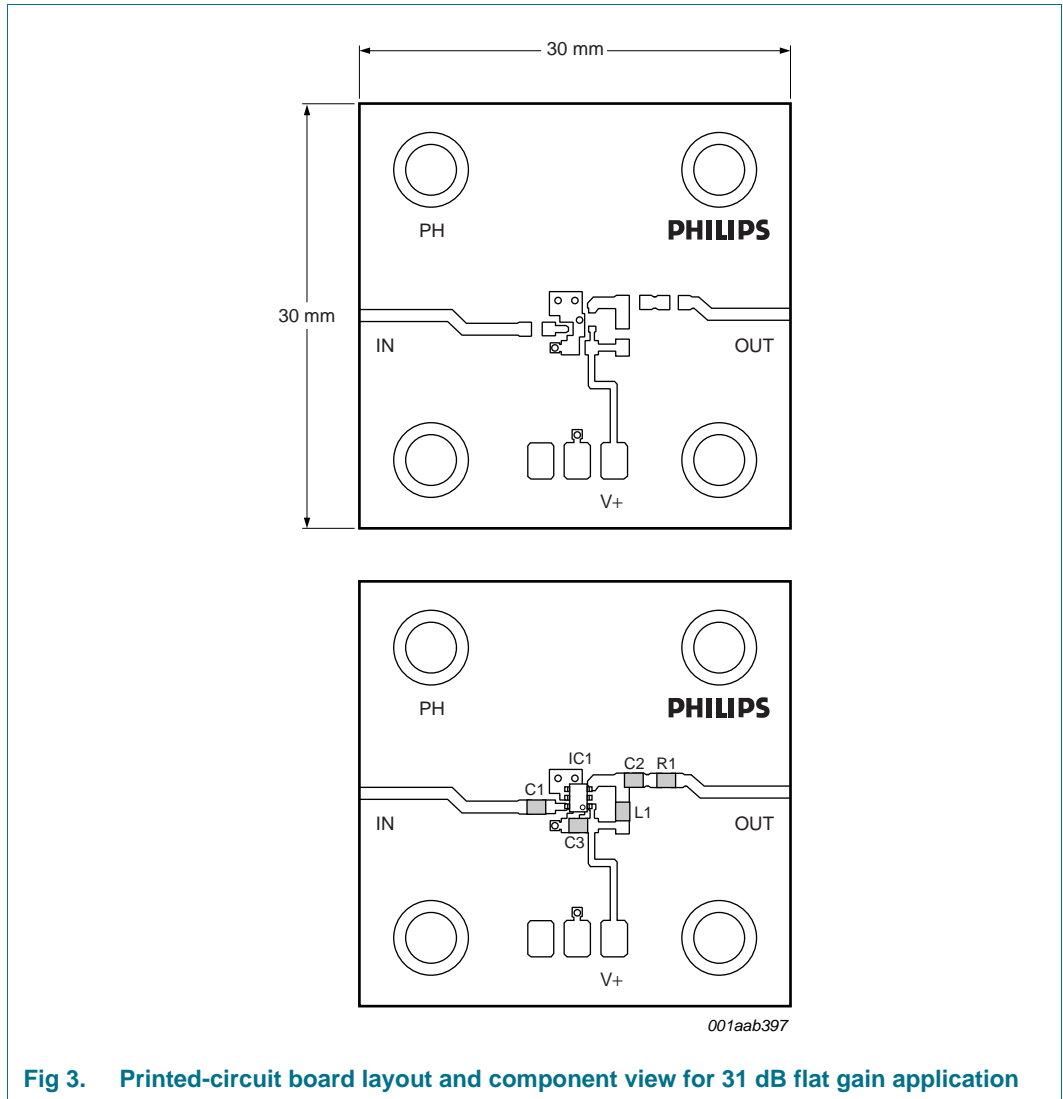

**Table 9. List of components used for the typical application**

Component	Description	Value	Dimensions
C1, C2	multilayer ceramic chip capacitor	100 pF	0603
C3	multilayer ceramic chip capacitor	22 nF	0603
R1	SMD resistor	-	0603
L1	SMD inductor	100 nH	0603

**9.1 Flat gain application: 31 dB between 800 MHz and 2.2 GHz**

By changing the components at the output of the amplifier, a flatter gain can be obtained. The gain is 31 dB ± 1 dB between 800 MHz and 2.2 GHz. P<sub>L(1dB)</sub> is 10 dBm at 1 GHz and 5.7 dBm at 2.2 GHz.

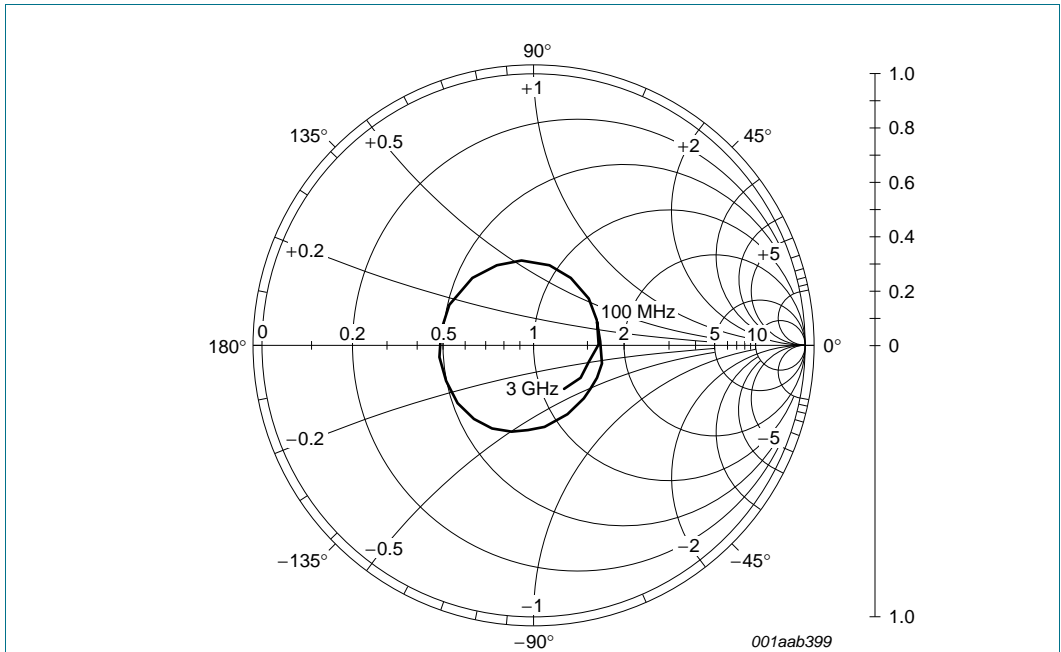

**Fig 3. Printed-circuit board layout and component view for 31 dB flat gain application**

**Table 10. List of components used for the 31 dB flat gain application<sup>[1]</sup>**

Component	Description	Value	Dimensions
C1	multilayer ceramic chip capacitor	100 pF	0603
C2	multilayer ceramic chip capacitor	4.7 pF	0603
C3	multilayer ceramic chip capacitor	22 nF	0603
R1	SMD resistor	27 Ω	0603
L1	SMD inductor	5.6 nH	0603

[1] Pin 2 should not be connected in order to obtain optimal input matching.



$I_S = 27.5 \text{ mA}$ ;  $V_S = 5 \text{ V}$ ;  $P_D = -35 \text{ dBm}$ ;  $Z_o = 50 \Omega$ .

**Fig 4. Input reflection coefficient ( $s_{11}$ ); typical values**

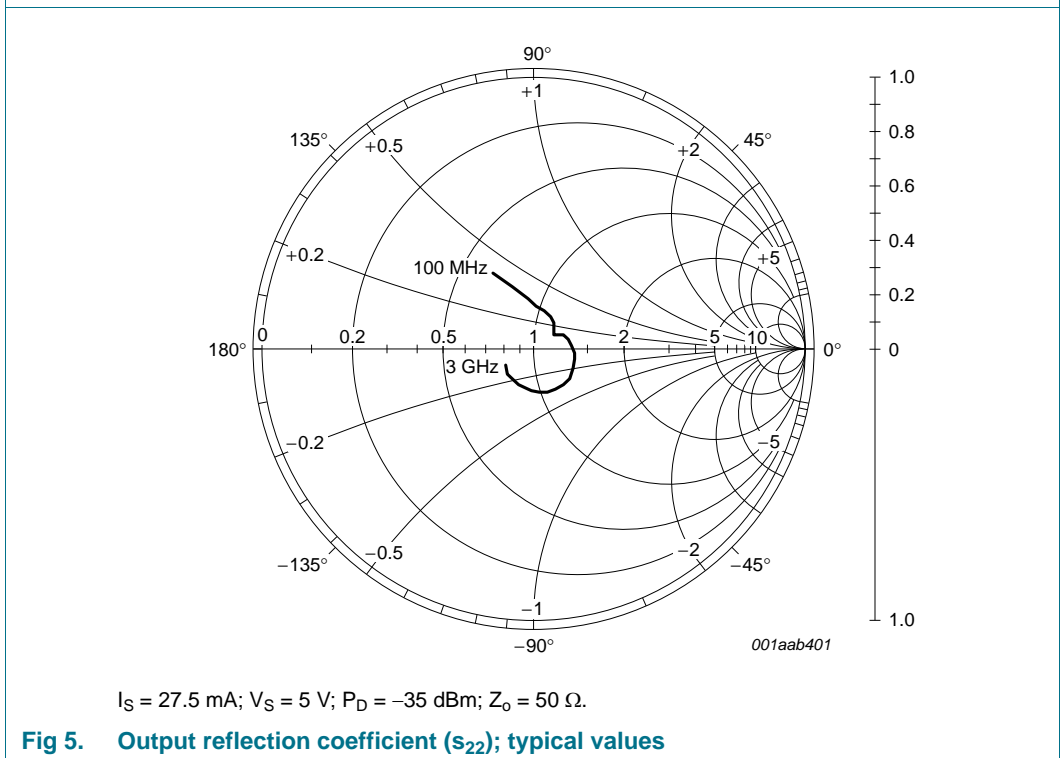

$I_S = 27.5 \text{ mA}$ ;  $V_S = 5 \text{ V}$ ;  $P_D = -35 \text{ dBm}$ ;  $Z_o = 50 \Omega$ .

**Fig 5. Output reflection coefficient ( $s_{22}$ ); typical values**

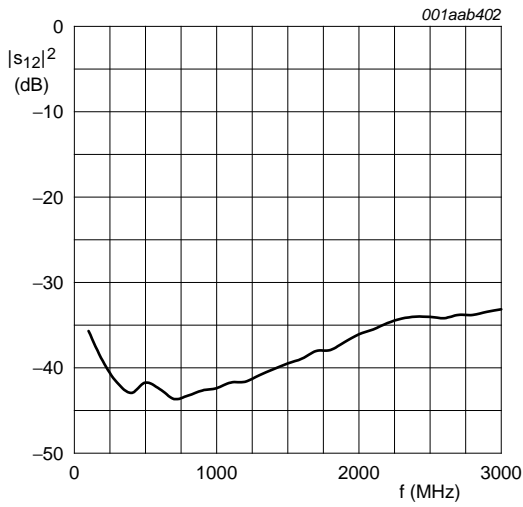

$I_S = 27.5 \text{ mA}$ ;  $V_S = 5 \text{ V}$ ;  $P_D = -35 \text{ dBm}$ ;  $Z_0 = 50 \Omega$ .

**Fig 6. Isolation ( $|s_{12}|^2$ ) as a function of frequency; typical values**

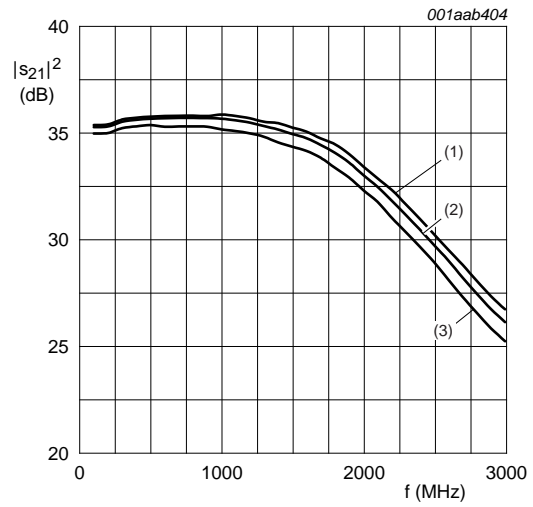

$P_D = -35 \text{ dBm}$ ;  $Z_0 = 50 \Omega$ .

- (1)  $I_S = 32.6 \text{ mA}$ ;  $V_S = 5.5 \text{ V}$ .
- (2)  $I_S = 27.5 \text{ mA}$ ;  $V_S = 5 \text{ V}$ .
- (3)  $I_S = 21.5 \text{ mA}$ ;  $V_S = 4.5 \text{ V}$ .

**Fig 7. Insertion gain ( $|s_{21}|^2$ ) as a function of frequency; typical values**

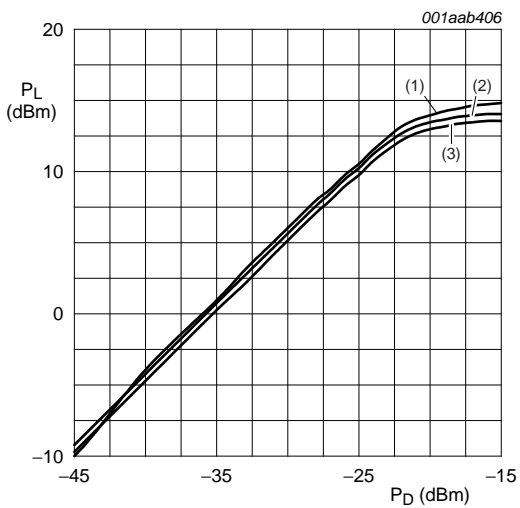

$f = 1 \text{ GHz}$ ;  $Z_0 = 50 \Omega$ .

- (1)  $V_S = 5.5 \text{ V}$ .
- (2)  $V_S = 5 \text{ V}$ .
- (3)  $V_S = 4.5 \text{ V}$ .

**Fig 8. Load power as a function of drive power at 1 GHz; typical values**

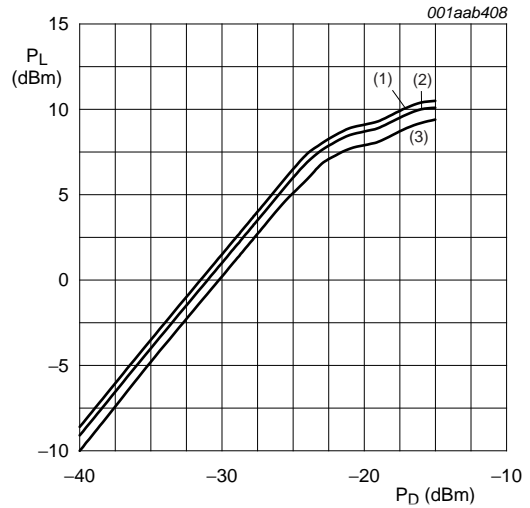

$f = 2.2 \text{ GHz}$ ;  $Z_0 = 50 \Omega$ .

- (1)  $V_S = 5.5 \text{ V}$ .
- (2)  $V_S = 5 \text{ V}$ .
- (3)  $V_S = 4.5 \text{ V}$ .

**Fig 9. Load power as a function of drive power at 2.2 GHz; typical values**



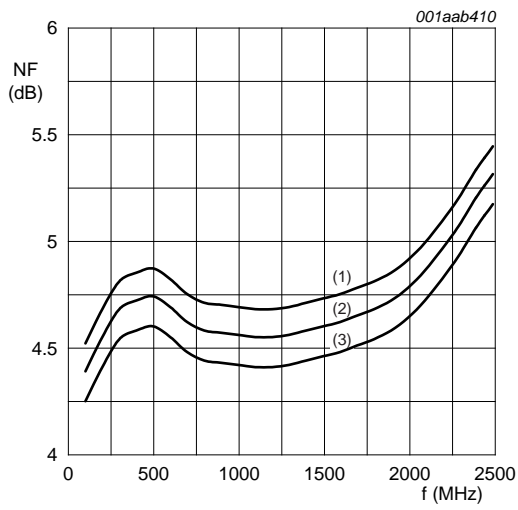

- $Z_o = 50 \Omega$ .
- (1)  $V_S = 5.5 \text{ V}$ .
  - (2)  $V_S = 5 \text{ V}$ .
  - (3)  $V_S = 4.5 \text{ V}$ .

**Fig 10. Noise figure as a function of frequency; typical values**

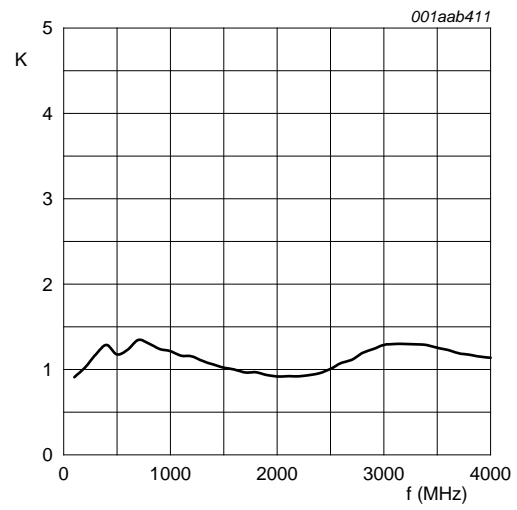

$I_S = 27.5 \text{ mA}$ ;  $V_S = 5 \text{ V}$ ;  $Z_o = 50 \Omega$ .

**Fig 11. Stability factor as a function of frequency; typical values**

**Table 11. Scattering parameters**

$V_S = 5\text{ V}$ ;  $I_S = 27.5\text{ mA}$ ;  $P_D = -35\text{ dBm}$ ;  $Z_o = 50\ \Omega$ ;  $T_{amb} = 25\text{ }^\circ\text{C}$ ; measured on demo board.

f (MHz)	S <sub>11</sub>		S <sub>21</sub>		S <sub>12</sub>		S <sub>22</sub>		K-factor
	Magnitude (ratio)	Angle (deg)	Magnitude (ratio)	Angle (deg)	Magnitude (ratio)	Angle (deg)	Magnitude (ratio)	Angle (deg)	
100	0.259	19.3	57.79	2.5	0.01642	47.3	0.325	118.6	0.9
200	0.258	3.2	57.96	-10.9	0.01096	20.7	0.248	110.9	1.0
400	0.270	-25.6	60.08	-41.2	0.00712	-12.6	0.163	87.0	1.3
600	0.271	-43.7	60.60	-67.0	0.00751	-13.9	0.134	63.2	1.2
800	0.281	-61.5	60.74	-95.6	0.00687	-12.1	0.104	43.7	1.3
1000	0.296	-80.1	60.44	-121.2	0.00759	-7.3	0.092	37.7	1.2
1200	0.317	-102.3	59.21	-147.1	0.00828	-11.5	0.097	33.9	1.2
1400	0.335	-127.7	57.01	-172.9	0.00981	-16.8	0.123	25.6	1.1
1600	0.334	-158.1	54.46	160.8	0.01130	-25.1	0.142	6.0	1.0
1800	0.331	169.6	50.31	134.1	0.01272	-34.0	0.157	-14.2	1.0
2000	0.326	130.6	44.63	104.7	0.01571	-43.0	0.172	-39.8	0.9
2200	0.309	95.9	38.92	79.4	0.01826	-57.0	0.172	-61.9	0.9
2400	0.287	59.0	33.31	55.5	0.01994	-69.2	0.161	-83.5	1.0
2600	0.257	20.4	28.20	33.1	0.01952	-78.3	0.147	-104.4	1.1
2800	0.224	-15.5	23.60	13.1	0.02037	-89.9	0.139	-125.1	1.2
3000	0.198	-50.7	20.24	-4.8	0.02198	-99.8	0.127	-151.5	1.3

10. Package outline

Plastic surface-mounted package; 6 leads

SOT363

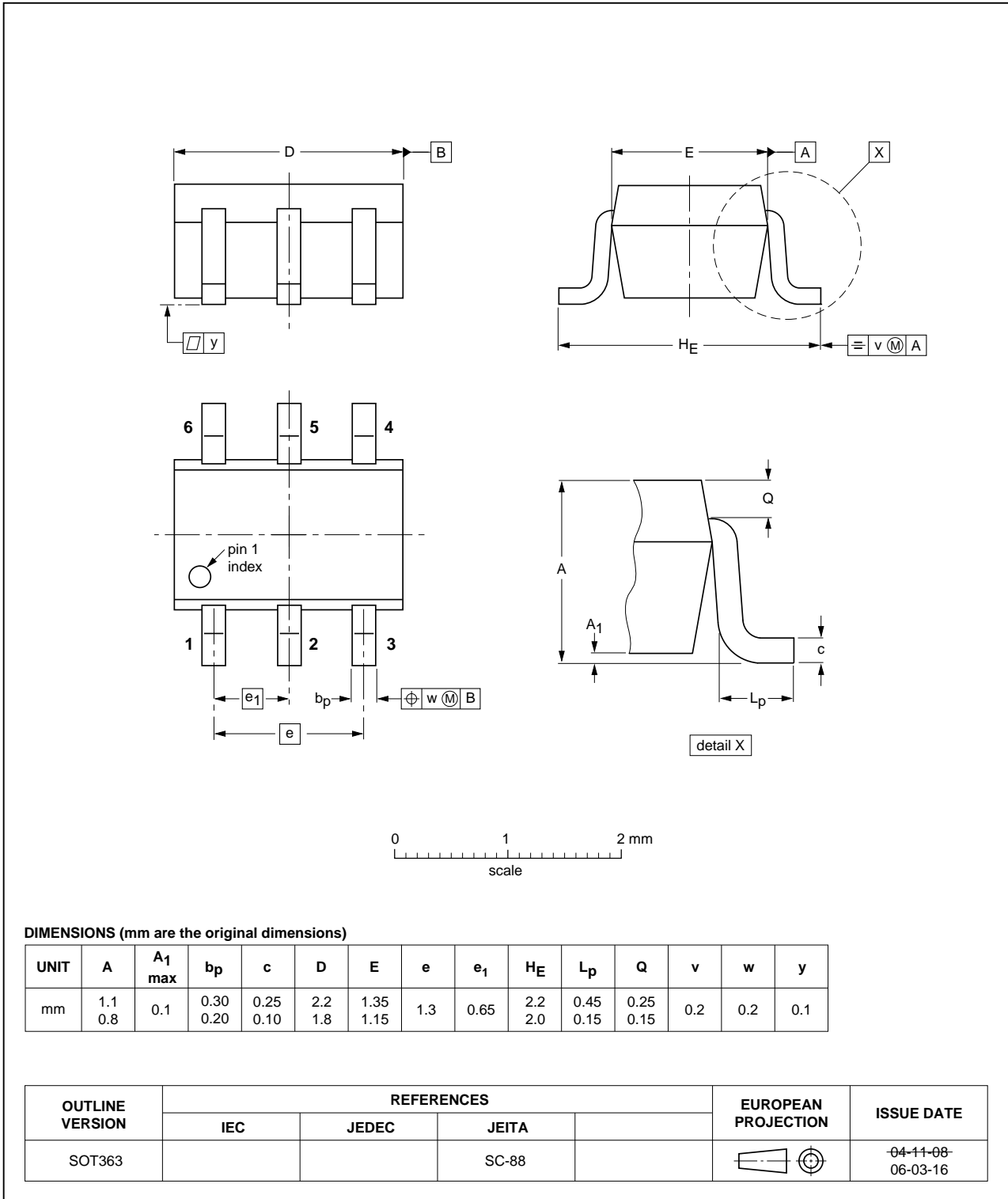

Fig 12. Package outline SOT363 (SC-88)

## 11. Revision history

Table 12. Revision history

Document ID	Release date	Data sheet status	Change notice	Supersedes
BGM1013 v.5	20110919	Product data sheet	-	BGM1013 v.4
Modifications:		<ul style="list-style-type: none"><li>• The format of this data sheet has been redesigned to comply with the new identity guidelines of NXP Semiconductors.</li><li>• Legal texts have been adapted to the new company name where appropriate.</li></ul>		
BGM1013 v.4	20060501	Product data sheet	-	BGM1013 v.3
BGM1013 v.3 (9397 750 14413)	20041209	Product data sheet	-	BGM1013 v.2
BGM1013 v.2 (9397 750 14229)	20041130	Product data sheet	-	BGM1013 v.1
BGM1013 v.1 (9397 750 13469)	20040831	Product data sheet	-	-

## 12. Legal information

### 12.1 Data sheet status

Document status <sup>[1][2]</sup>	Product status <sup>[3]</sup>	Definition
Objective [short] data sheet	Development	This document contains data from the objective specification for product development.
Preliminary [short] data sheet	Qualification	This document contains data from the preliminary specification.
Product [short] data sheet	Production	This document contains the product specification.

[1] Please consult the most recently issued document before initiating or completing a design.

[2] The term 'short data sheet' is explained in section "Definitions".

[3] The product status of device(s) described in this document may have changed since this document was published and may differ in case of multiple devices. The latest product status information is available on the Internet at URL <http://www.nxp.com>.

### 12.2 Definitions

**Draft** — The document is a draft version only. The content is still under internal review and subject to formal approval, which may result in modifications or additions. NXP Semiconductors does not give any representations or warranties as to the accuracy or completeness of information included herein and shall have no liability for the consequences of use of such information.

**Short data sheet** — A short data sheet is an extract from a full data sheet with the same product type number(s) and title. A short data sheet is intended for quick reference only and should not be relied upon to contain detailed and full information. For detailed and full information see the relevant full data sheet, which is available on request via the local NXP Semiconductors sales office. In case of any inconsistency or conflict with the short data sheet, the full data sheet shall prevail.

**Product specification** — The information and data provided in a Product data sheet shall define the specification of the product as agreed between NXP Semiconductors and its customer, unless NXP Semiconductors and customer have explicitly agreed otherwise in writing. In no event however, shall an agreement be valid in which the NXP Semiconductors product is deemed to offer functions and qualities beyond those described in the Product data sheet.

### 12.3 Disclaimers

**Limited warranty and liability** — Information in this document is believed to be accurate and reliable. However, NXP Semiconductors does not give any representations or warranties, expressed or implied, as to the accuracy or completeness of such information and shall have no liability for the consequences of use of such information.

In no event shall NXP Semiconductors be liable for any indirect, incidental, punitive, special or consequential damages (including - without limitation - lost profits, lost savings, business interruption, costs related to the removal or replacement of any products or rework charges) whether or not such damages are based on tort (including negligence), warranty, breach of contract or any other legal theory.

Notwithstanding any damages that customer might incur for any reason whatsoever, NXP Semiconductors' aggregate and cumulative liability towards customer for the products described herein shall be limited in accordance with the *Terms and conditions of commercial sale* of NXP Semiconductors.

**Right to make changes** — NXP Semiconductors reserves the right to make changes to information published in this document, including without limitation specifications and product descriptions, at any time and without notice. This document supersedes and replaces all information supplied prior to the publication hereof.

**Suitability for use** — NXP Semiconductors products are not designed, authorized or warranted to be suitable for use in life support, life-critical or safety-critical systems or equipment, nor in applications where failure or

malfunction of an NXP Semiconductors product can reasonably be expected to result in personal injury, death or severe property or environmental damage. NXP Semiconductors accepts no liability for inclusion and/or use of NXP Semiconductors products in such equipment or applications and therefore such inclusion and/or use is at the customer's own risk.

**Applications** — Applications that are described herein for any of these products are for illustrative purposes only. NXP Semiconductors makes no representation or warranty that such applications will be suitable for the specified use without further testing or modification.

Customers are responsible for the design and operation of their applications and products using NXP Semiconductors products, and NXP Semiconductors accepts no liability for any assistance with applications or customer product design. It is customer's sole responsibility to determine whether the NXP Semiconductors product is suitable and fit for the customer's applications and products planned, as well as for the planned application and use of customer's third party customer(s). Customers should provide appropriate design and operating safeguards to minimize the risks associated with their applications and products.

NXP Semiconductors does not accept any liability related to any default, damage, costs or problem which is based on any weakness or default in the customer's applications or products, or the application or use by customer's third party customer(s). Customer is responsible for doing all necessary testing for the customer's applications and products using NXP Semiconductors products in order to avoid a default of the applications and the products or of the application or use by customer's third party customer(s). NXP does not accept any liability in this respect.

**Limiting values** — Stress above one or more limiting values (as defined in the Absolute Maximum Ratings System of IEC 60134) will cause permanent damage to the device. Limiting values are stress ratings only and (proper) operation of the device at these or any other conditions above those given in the Recommended operating conditions section (if present) or the Characteristics sections of this document is not warranted. Constant or repeated exposure to limiting values will permanently and irreversibly affect the quality and reliability of the device.

**Terms and conditions of commercial sale** — NXP Semiconductors products are sold subject to the general terms and conditions of commercial sale, as published at <http://www.nxp.com/profile/terms>, unless otherwise agreed in a valid written individual agreement. In case an individual agreement is concluded only the terms and conditions of the respective agreement shall apply. NXP Semiconductors hereby expressly objects to applying the customer's general terms and conditions with regard to the purchase of NXP Semiconductors products by customer.

**No offer to sell or license** — Nothing in this document may be interpreted or construed as an offer to sell products that is open for acceptance or the grant, conveyance or implication of any license under any copyrights, patents or other industrial or intellectual property rights.

**Export control** — This document as well as the item(s) described herein may be subject to export control regulations. Export might require a prior authorization from national authorities.

**Quick reference data** — The Quick reference data is an extract of the product data given in the Limiting values and Characteristics sections of this document, and as such is not complete, exhaustive or legally binding.

**Non-automotive qualified products** — Unless this data sheet expressly states that this specific NXP Semiconductors product is automotive qualified, the product is not suitable for automotive use. It is neither qualified nor tested in accordance with automotive testing or application requirements. NXP Semiconductors accepts no liability for inclusion and/or use of non-automotive qualified products in automotive equipment or applications.

In the event that customer uses the product for design-in and use in automotive applications to automotive specifications and standards, customer (a) shall use the product without NXP Semiconductors' warranty of the

product for such automotive applications, use and specifications, and (b) whenever customer uses the product for automotive applications beyond NXP Semiconductors' specifications such use shall be solely at customer's own risk, and (c) customer fully indemnifies NXP Semiconductors for any liability, damages or failed product claims resulting from customer design and use of the product for automotive applications beyond NXP Semiconductors' standard warranty and NXP Semiconductors' product specifications.

## 12.4 Trademarks

Notice: All referenced brands, product names, service names and trademarks are the property of their respective owners.

## 13. Contact information

For more information, please visit: <http://www.nxp.com>

For sales office addresses, please send an email to: [salesaddresses@nxp.com](mailto:salesaddresses@nxp.com)

## 14. Contents

<b>1</b>	<b>Product profile</b> . . . . .	<b>1</b>
1.1	General description . . . . .	1
1.2	Features and benefits . . . . .	1
1.3	Applications . . . . .	1
1.4	Quick reference data . . . . .	1
<b>2</b>	<b>Pinning information</b> . . . . .	<b>2</b>
<b>3</b>	<b>Ordering information</b> . . . . .	<b>2</b>
<b>4</b>	<b>Marking</b> . . . . .	<b>2</b>
<b>5</b>	<b>Limiting values</b> . . . . .	<b>2</b>
<b>6</b>	<b>Recommended operating conditions</b> . . . . .	<b>3</b>
<b>7</b>	<b>Thermal characteristics</b> . . . . .	<b>3</b>
<b>8</b>	<b>Characteristics</b> . . . . .	<b>3</b>
<b>9</b>	<b>Application information</b> . . . . .	<b>4</b>
9.1	Flat gain application: 31 dB between 800 MHz and 2.2 GHz . . . . .	6
<b>10</b>	<b>Package outline</b> . . . . .	<b>11</b>
<b>11</b>	<b>Revision history</b> . . . . .	<b>12</b>
<b>12</b>	<b>Legal information</b> . . . . .	<b>13</b>
12.1	Data sheet status . . . . .	13
12.2	Definitions . . . . .	13
12.3	Disclaimers . . . . .	13
12.4	Trademarks . . . . .	14
<b>13</b>	<b>Contact information</b> . . . . .	<b>14</b>
<b>14</b>	<b>Contents</b> . . . . .	<b>15</b>

Please be aware that important notices concerning this document and the product(s) described herein, have been included in section 'Legal information'.

© NXP B.V. 2011.

All rights reserved.

For more information, please visit: <http://www.nxp.com>

For sales office addresses, please send an email to: [salesaddresses@nxp.com](mailto:salesaddresses@nxp.com)

Date of release: 19 September 2011

Document identifier: BGM1013

# Mouser Electronics

Authorized Distributor

Click to View Pricing, Inventory, Delivery & Lifecycle Information:

[NXP:](#)

[BGM1013,115](#)