

## Class R Fuseblocks Catalog Data

Catalog Number	Covers		Voltage	Current	Number of Poles	Label
	Class R	w/o Indication				
RM25100-1CR	CVR-RH-25100	CVRI-RH-25100	250	100	1	RM25100-1CR
RM25100-2CR					2	RM25100-2CR
RM25100-3CR					3	RM25100-3CR
RM25200-1CR	CVR-RH-25200	CVRI-RH-25200		200	1	RM25200-1CR
RM25200-2CR					2	RM25200-2CR
RM25200-3CR					3	RM25200-3CR
RM25400-1CR	CVR-RH-25400	CVRI-RH-25400		400	1	RM25400-1CR
RM25400-2CR					2	RM25400-2CR
RM25400-3CR					3	RM25400-3CR
RM25600-1CR	CVR-RH-25600	CVRI-RH-25600		600	1	RM25600-1CR
RM25600-2CR					2	RM25600-2CR
RM25600-3CR					3	RM25600-3CR

Catalog Number	Covers		Voltage	Current	Number of Poles	Label
	Class R	w/o Indication				
RM60100-1CR	CVR-RH-60100	CVRI-RH-60100	600	100	1	RM60100-1CR
RM60100-2CR					2	RM60100-2CR
RM60100-3CR					3	RM60100-3CR
RM60200-1CR	CVR-RH-60200	CVRI-RH-60200		200	1	RM60200-1CR
RM60200-2CR					2	RM60200-2CR
RM60200-3CR					3	RM60200-3CR
RM60400-1CR	CVR-RH-60400	CVRI-RH-60400		400	1	RM60400-1CR
RM60400-2CR					2	RM60400-2CR
RM60400-3CR					3	RM60400-3CR
RM60600-1CR	CVR-RH-60600	CVRI-RH-60600		600	1	RM60600-1CR
RM60600-2CR					2	RM60600-2CR
RM60600-3CR					3	RM60600-3CR

**COOPER Bussmann**  
St. Louis MO 63178

TITLE:

**Class R fuse holder-CUST**

SCALE: 1:1

SIZE: A3

SHEET: 1 OF 14



PUSH DOWN

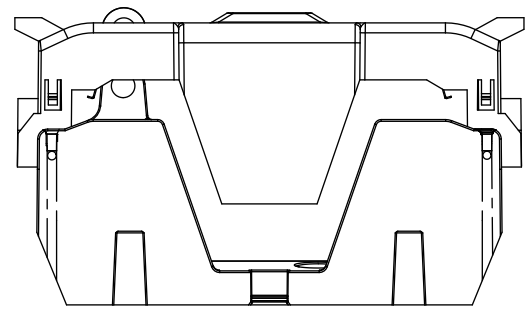

LIFT UP

LIFT UP, THEN ROTATE OVER

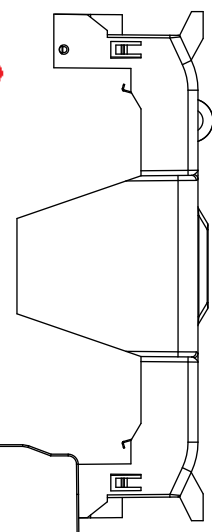
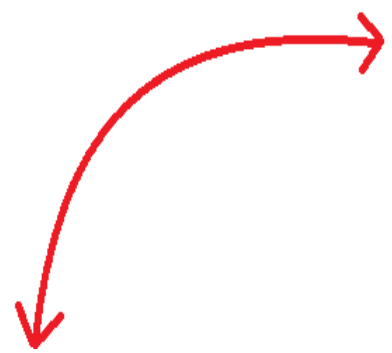

 St. Louis MO 63178		
TITLE:		
<b>Class R fuse holder-CUST</b>		
SCALE: 1:2	SIZE: A3	SHEET: 2 OF 14
www.Bussmann.com		

**RM25100-1CR**



**RM25100-1CR WITH CVR-RH-25100 INSTALLED**



**RM25100-1CR WITH CVRI-RH-25100 INSTALLED**

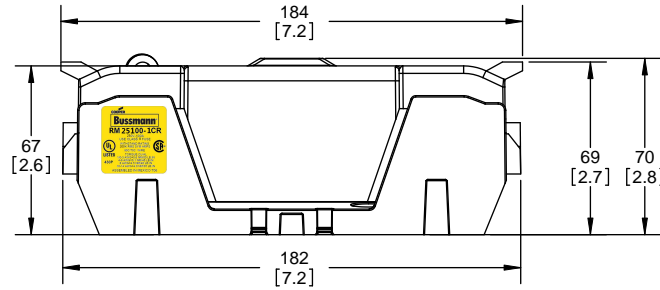

**CVR-RH-25100**

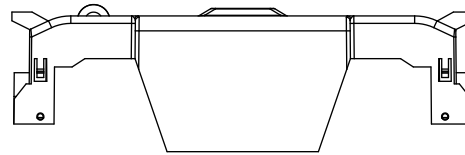

**CVRI-RH-25100**

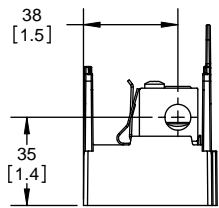

**COOPER Bussmann**  
St. Louis MO 63178

TITLE: **Class R fuse holder-CUST-250V**

SCALE: 1:1 SIZE: A3 SHEET: 3 OF 14

DESIGN UNITS: METRIC (mm)  
UNLESS OTHERWISE SPECIFIED  
[INCHES]



THIRD ANGLE PROJECTION

**RM25100-2CR**



**RM25100-2CR  
WITH CVR-RH-25100 INSTALLED**



**RM25100-2CR  
WITH CVRI-RH-25100 INSTALLED**

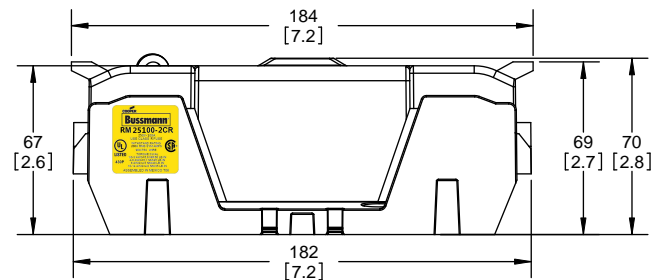
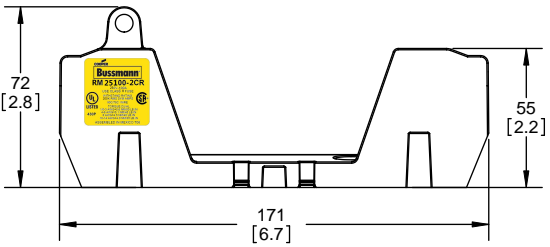

**COOPER Bussmann**  
St. Louis MO 63178

TITLE:  
**Class R fuse holder-CUST-250V**

SCALE: 1:1      SIZE: A3      SHEET: 4 OF 14

DESIGN UNITS: METRIC (mm)  
UNLESS OTHERWISE SPECIFIED [INCHES]



THIRD ANGLE PROJECTION

**RM25100-3CR**



**RM25100-3CR  
WITH CVR-RH-25100 INSTALLED**



**RM25100-3CR  
WITH CVRI-RH-25100 INSTALLED**

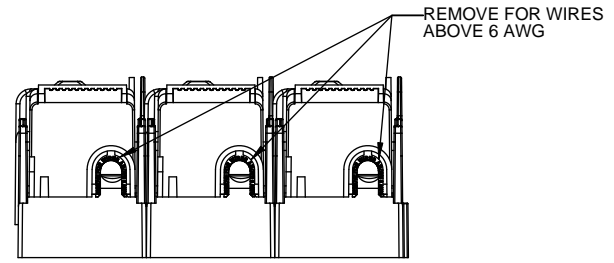

**COOPER Bussmann**  
St. Louis MO 63178

TITLE:  
**Class R fuse holder-CUST-250V**

SCALE: 1:1      SIZE: A3      SHEET: 5 OF 14

DESIGN UNITS: METRIC (mm) / UNLESS OTHERWISE SPECIFIED [INCHES] THIRD ANGLE PROJECTION

**RM25200-1CR**

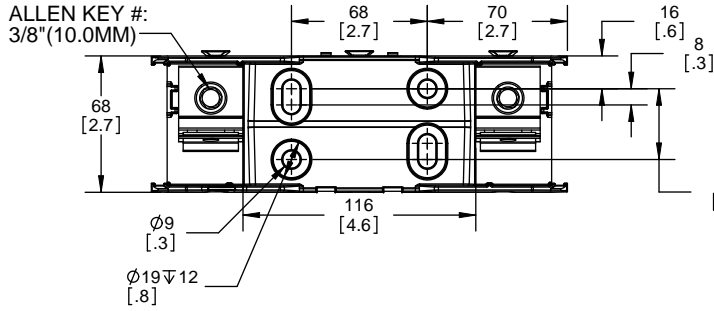

**RM25200-1CR WITH CVR-RH-25200 INSTALLED**

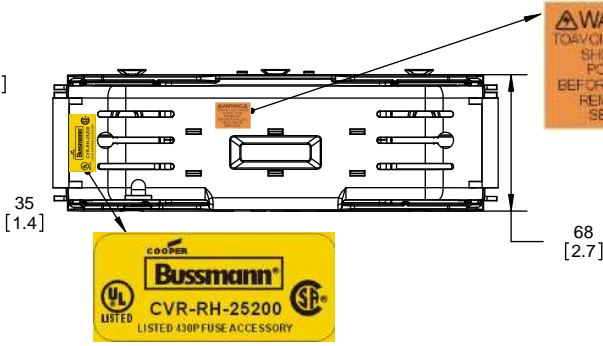

**RM25200-1CR WITH CVRI-RH-25200 INSTALLED**

**WARNING**  
 ⚠️ TO AVOID ELECTRICAL SHOCK, TURN POWER OFF BEFORE INSTALLING, REMOVING OR SERVICING.

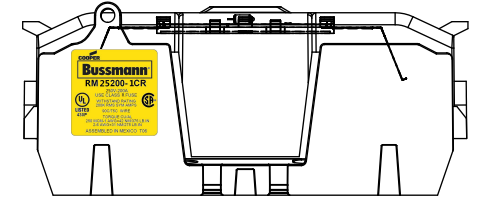
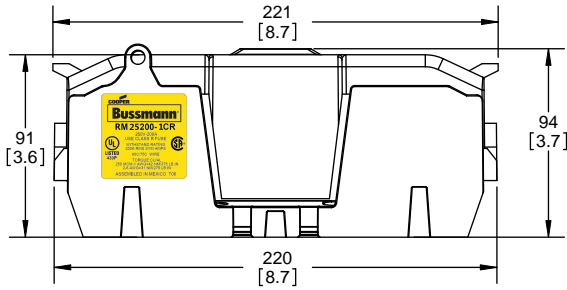
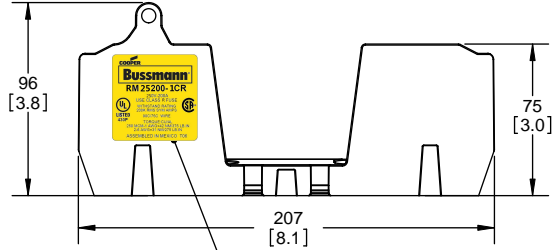
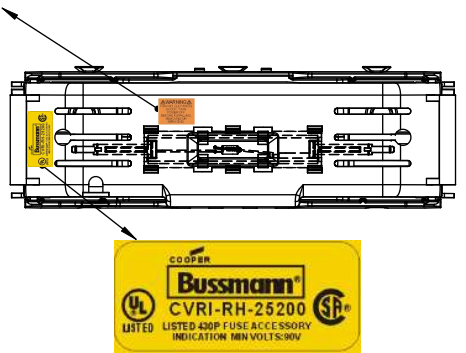

**COOPER Bussmann RM 25200-1CR**

250V-200A  
 USE CLASS R FUSE  
 WITHSTAND RATING  
 200K RMS SYM AMPS  
 90C/75C WIRE  
 TORQUE: CU/AL  
 250 MCM-1 AWG=42 NM/375 LB.IN  
 2-6 AWG=31 NM/275 LB.IN  
 ASSEMBLED IN MEXICO T06

UL LISTED 430P SF

**CVR-RH-25200**

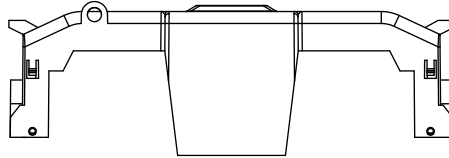

**CVRI-RH-25200**

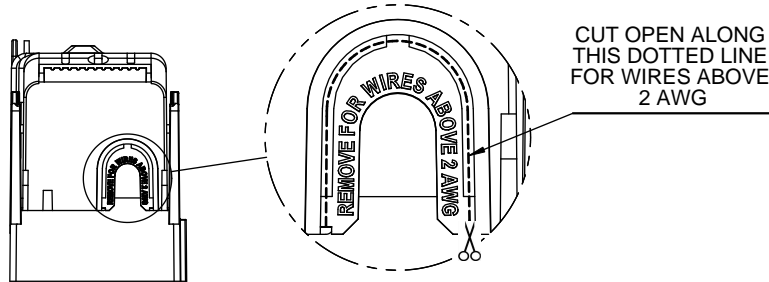
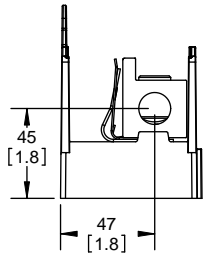
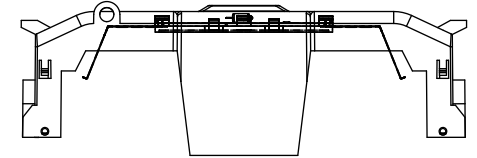

**COOPER Bussmann**  
 St. Louis MO 63178

TITLE: **Class R fuse holder-CUST-250V**

SCALE: 1:1 SIZE: A3 SHEET: 6 OF 14

DESIGN UNITS: METRIC (mm)  
UNLESS OTHERWISE SPECIFIED  
[INCHES]



THIRD ANGLE PROJECTION

**RM25200-2CR**

**RM25200-2CR  
WITH CVR-RH-25200 INSTALLED**

**RM25200-2CR  
WITH CVRI-RH-25200 INSTALLED**



**COOPER Bussmann**  
St. Louis MO 63178

TITLE:  
**Class R fuse holder-CUST-250V**

SCALE: 1:1      SIZE: A3      SHEET: 7 OF 14

DESIGN UNITS: METRIC (mm)  
UNLESS OTHERWISE SPECIFIED [INCHES]



THIRD ANGLE PROJECTION

**RM25200-3CR**

**RM25200-3CR  
WITH CVR-RH-25200 INSTALLED**

**RM25200-3CR  
WITH CVRI-RH-25200 INSTALLED**

ALLEN KEY #:  
3/8" (10.0MM)



**COOPER Bussmann**  
St. Louis MO 63178

TITLE:  
**Class R fuse holder-CUST-250V**

SCALE: 1:1      SIZE: A3      SHEET: 8 OF 14



DESIGN UNITS: METRIC (mm)  
UNLESS OTHERWISE SPECIFIED  
[INCHES]

THIRD ANGLE PROJECTION

**RM25400-1CR**



**RM25400-1CR  
WITH CVR-RH-25400 INSTALLED**

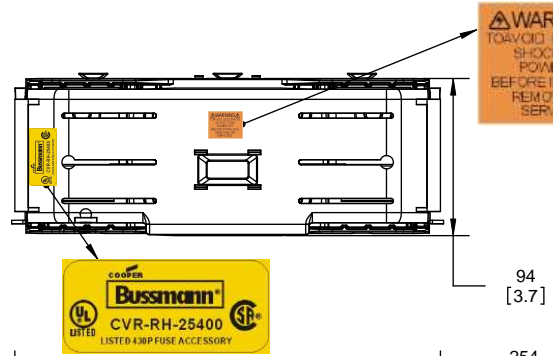

**RM25400-1CR  
WITH CVRI-RH-25400 INSTALLED**

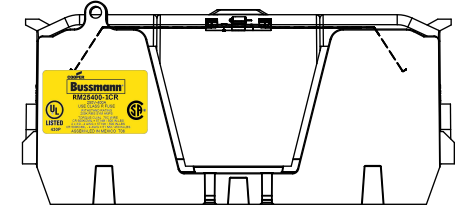
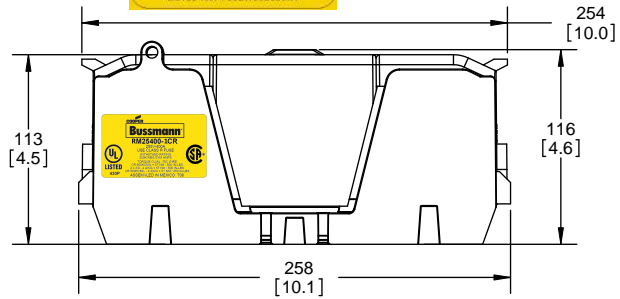
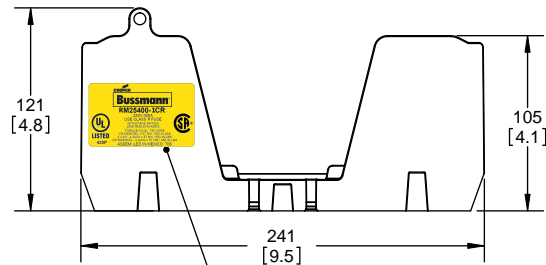
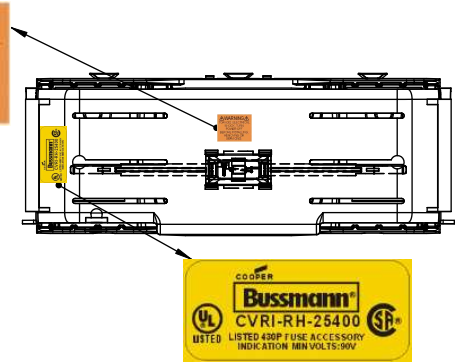

**CVR-RH-25400**

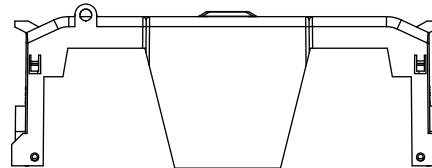

**CVRI-RH-25400**

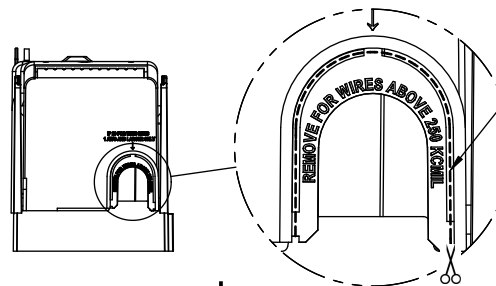
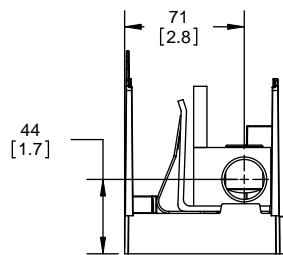
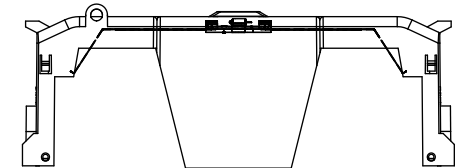

**COOPER Bussmann**  
St. Louis MO 63178

**Class R fuse holder-CUST-250V**

SCALE: 1:1 SIZE: A3 SHEET: 9 OF 14

DESIGN UNITS: METRIC (mm)  
UNLESS OTHERWISE SPECIFIED [INCHES]



THIRD ANGLE PROJECTION

**RM25400-2CR**



**RM25400-2CR  
WITH CVR-RH-25400 INSTALLED**



**RM25400-2CR  
WITH CVRI-RH-25400 INSTALLED**

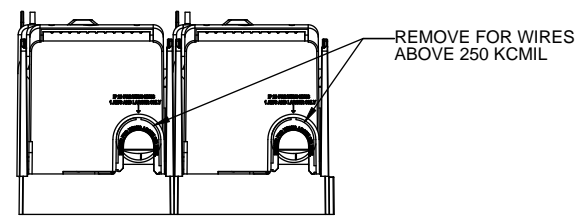

**COOPER Bussmann**  
St. Louis MO 63178

TITLE:  
**Class R fuse holder-CUST-250V**

SCALE: 1:1      SIZE: A3      SHEET: 10 OF 14

DESIGN UNITS: METRIC (mm)  
UNLESS OTHERWISE SPECIFIED  
[INCHES]



THIRD ANGLE PROJECTION

RM25400-3CR

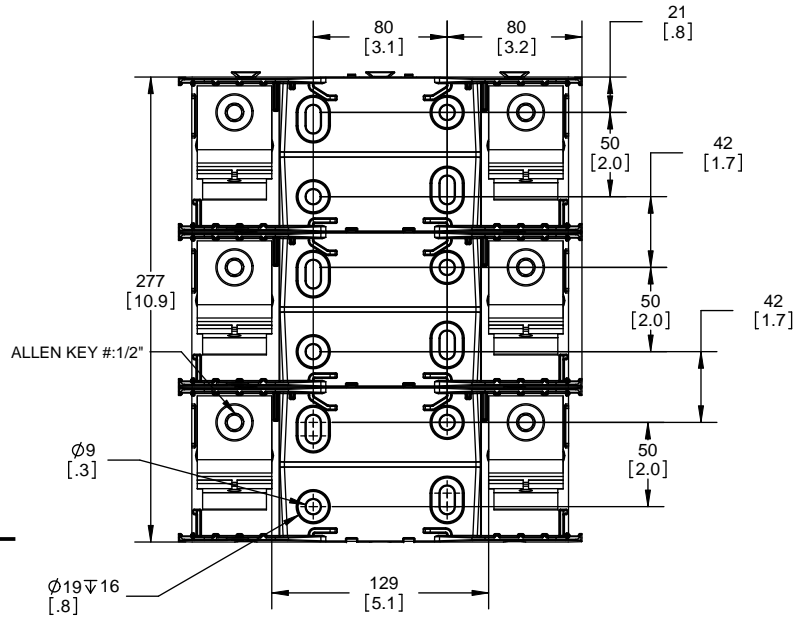

RM25400-3CR  
WITH CVR-RH-25400 INSTALLED



RM25400-3CR  
WITH CVRI-RH-25400 INSTALLED



**COOPER Bussmann**  
St. Louis MO 63178

TITLE:  
**Class R fuse holder-CUST-250V**

SCALE: 1:1      SIZE: A3      SHEET: 11 OF 14

DESIGN UNITS: METRIC (mm) UNLESS OTHERWISE SPECIFIED  
 THIRD ANGLE PROJECTION

**RM25600-1CR**



**RM25600-1CR WITH CVR-RH-25600 INSTALLED**

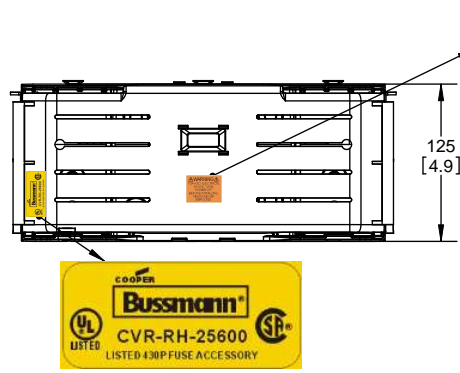

**RM25600-1CR WITH CVRI-RH-25600 INSTALLED**

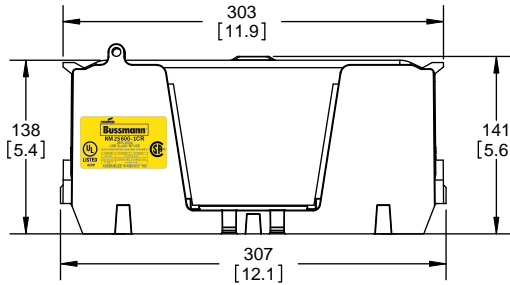
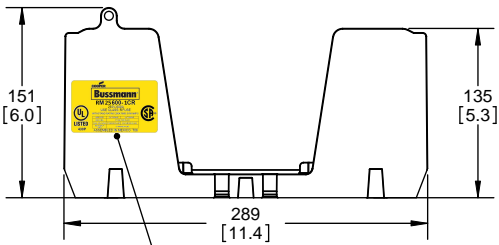
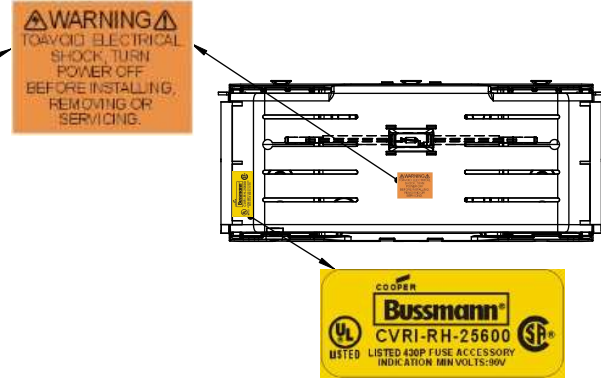

**CVR-RH-25600**

**CVRI-RH-25600**

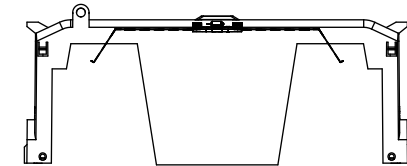
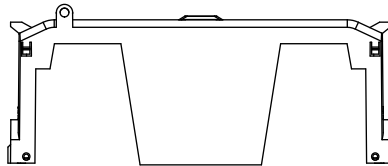

**COOPER Bussmann**  
**RM 25600-1CR**  
 250V-600A  
 USE CLASS R FUSE  
 WITHSTAND RATING 200K RMS SYM AMPS

WIRE SIZE	CUT TORQUE	AL TORQUE
600 KCMIL	87 NM / 620 IN-LBS	
DUAL 304 AWG	37 NM/300 IN-LBS	33.9 NM/300 IN-LBS
100 KCMIL	51 NM/450 IN-LBS	

UL LISTED 430P SA  
 ASSEMBLED IN MEXICO T06

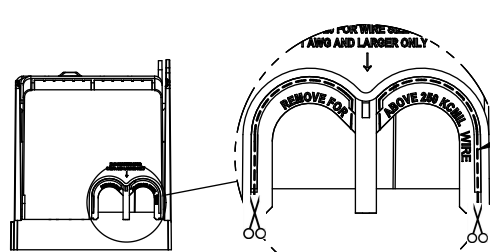

CUT OPEN ALONG THIS DOTTED LINE FOR WIRES ABOVE 250 KCMIL

**COOPER Bussmann**  
 St. Louis MO 63178

**Class R fuse holder-CUST-250V**

SCALE: 1:1 SIZE: A3 SHEET: 12 OF 14

DESIGN UNITS: METRIC (mm)  
UNLESS OTHERWISE SPECIFIED  
[INCHES]



THIRD ANGLE PROJECTION

**RM25600-2CR**

**RM25600-2CR  
WITH CVR-RH-25600 INSTALLED**

**RM25600-2CR  
WITH CVRI-RH-25600 INSTALLED**



**COOPER Bussmann**  
St. Louis MO 63178

TITLE:  
**Class R fuse holder-CUST-250V**

SCALE: 1:1      SIZE: A3      SHEET: 13 OF 14

DESIGN UNITS: METRIC (mm)  
UNLESS OTHERWISE SPECIFIED  
[INCHES]



THIRD ANGLE PROJECTION

**RM25600-3CR**



**RM25600-3CR  
WITH CVR-RH-25600 INSTALLED**



**RM25600-3CR  
WITH CVRI-RH-25600 INSTALLED**



**COOPER Bussmann**  
St. Louis MO 63178

TITLE:  
**Class R fuse holder-CUST-250V**

SCALE: 1:1      SIZE: A3      SHEET: 14 OF 14

REVISONS			DATE	ECN	BY
REV	ZONE	DESCRIPTION			

**RM60100-1CR**

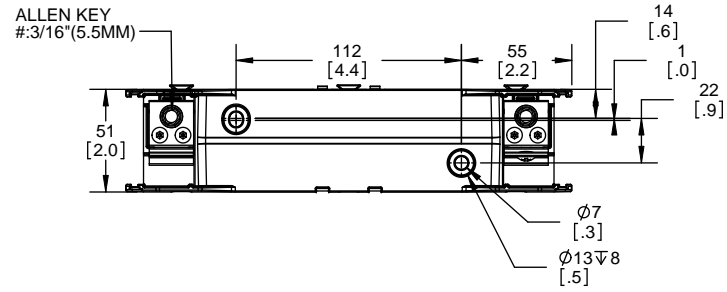

**RM60100-1CR WITH CVR-RH-60100 INSTALLED**

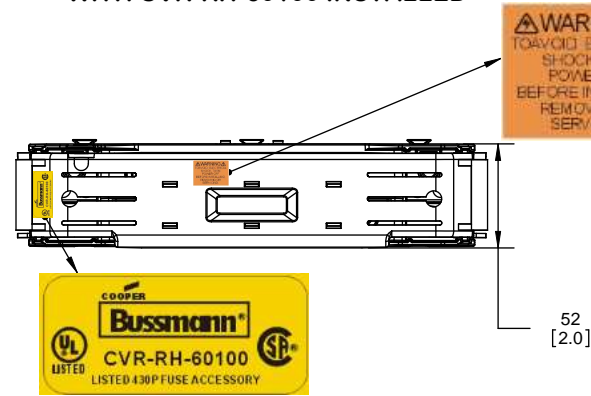

**RM60100-1CR WITH CVRI-RH-60100 INSTALLED**

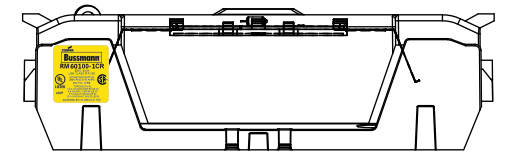
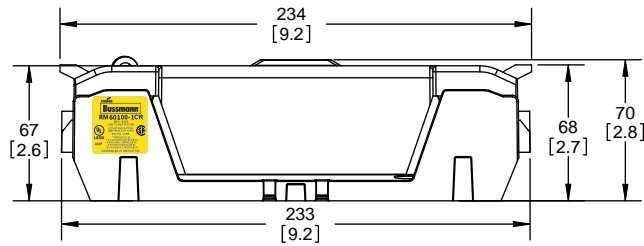
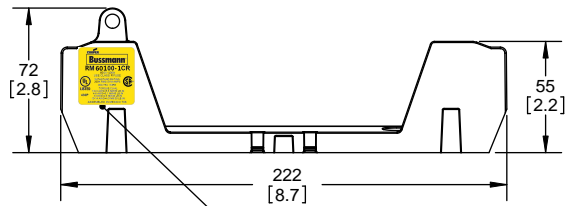
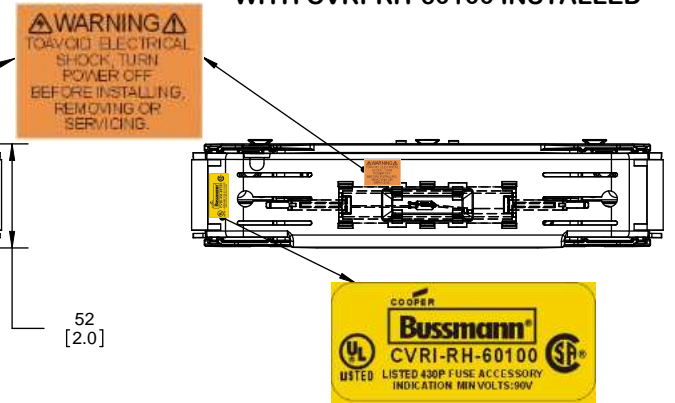

**CVR-RH-60100**

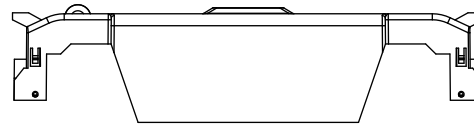

**CVRI-RH-60100**

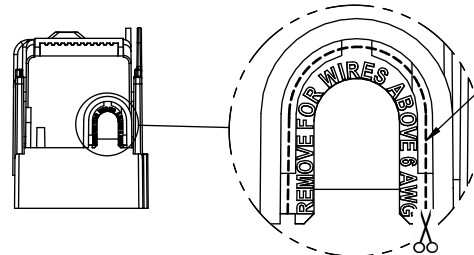
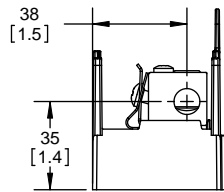
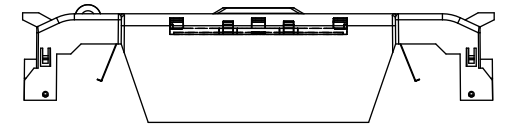

**COOPER Bussmann**  
 St. Louis MO 63178

TITLE: **Class R fuse holder-CUST-600V**

SCALE: 1:1 SIZE: A3 SHEET: 1 OF 12

DESIGN UNITS: METRIC (mm)  
UNLESS OTHERWISE SPECIFIED  
[INCHES]

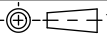

THIRD ANGLE PROJECTION

REVISIONS					DATE	ECN	BY
REV	ZONE	DESCRIPTION					

**RM60100-2CR**

**RM60100-2CR  
WITH CVR-RH-60100 INSTALLED**

**RM60100-2CR  
WITH CVRI-RH-60100 INSTALLED**

ALLEN KEY  
#3/16" (5.5MM)



**COOPER Bussmann**  
St. Louis MO 63178

TITLE:  
**Class R fuse holder-CUST-600V**

SCALE: 1:1      SIZE: A3      SHEET: 2 OF 12



**RM60100-3CR**

**RM60100-3CR WITH CVR-RH-60100 INSTALLED**

**RM60100-3CR WITH CVRI-RH-60100 INSTALLED**



**COOPER Bussmann**  
St. Louis MO 63178

TITLE:  
**Class R fuse holder-CUST-600V**

SCALE: 1:1      SIZE: A3      SHEET: 3 OF 12

REVISIONS				DATE	ECN	BY
REV	ZONE	DESCRIPTION				

**RM60200-1CR**

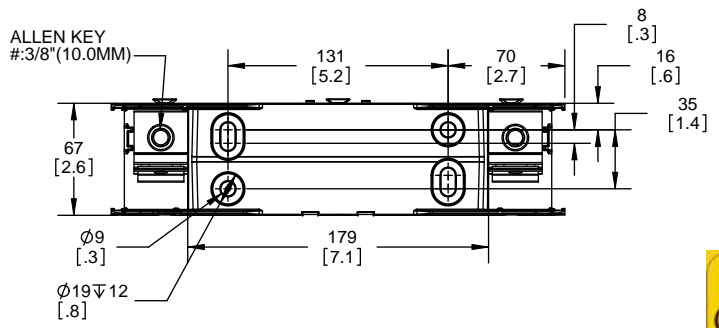

**RM60200-1CR WITH CVR-RH-60200 INSTALLED**

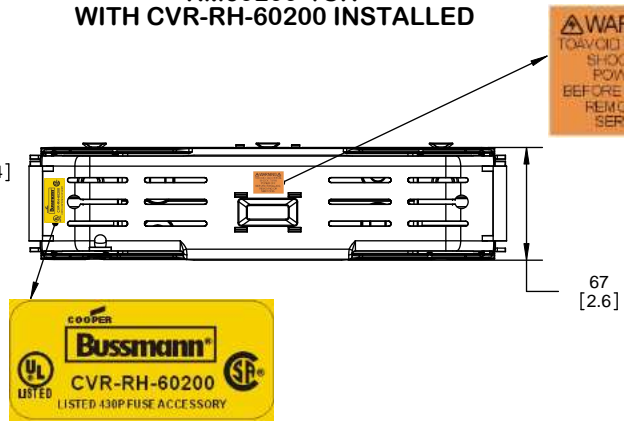

**WARNING**  
TO AVOID ELECTRICAL SHOCK, TURN POWER OFF BEFORE INSTALLING, REMOVING OR SERVICING.

**RM60200-1CR WITH CVRI-RH-60200 INSTALLED**

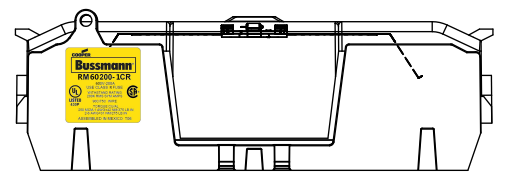
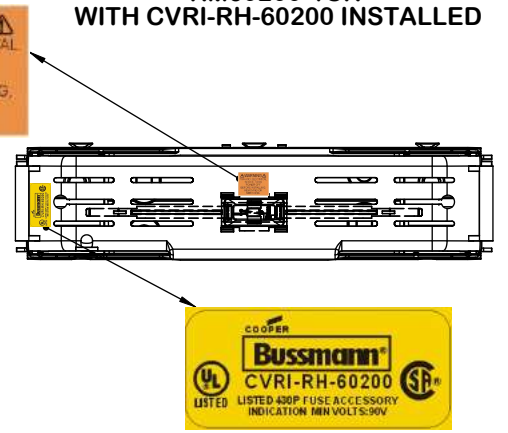

**CVR-RH-60200**

**CVRI-RH-60200**

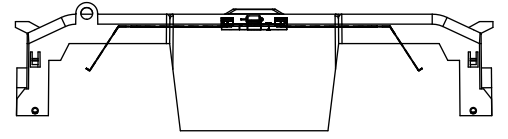

**COOPER Bussmann**  
St. Louis MO 63178

TITLE: **Class R fuse holder-CUST-600V**

SCALE: 1:1 SIZE: A3 SHEET: 4 OF 12

**RM60200-2CR**

**RM60200-2CR  
WITH CVR-RH-60200 INSTALLED**

**RM60200-2CR  
WITH CVRI-RH-60200 INSTALLED**

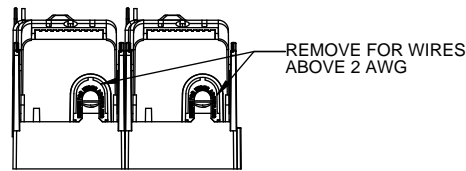
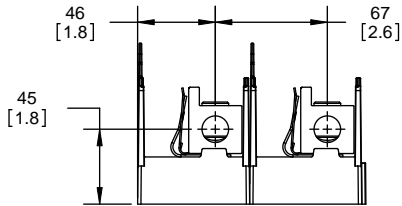
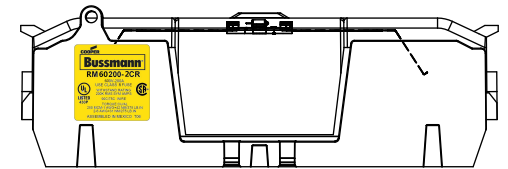
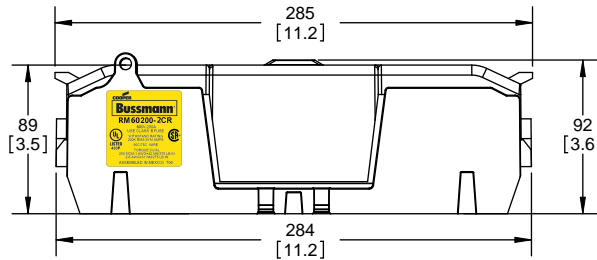
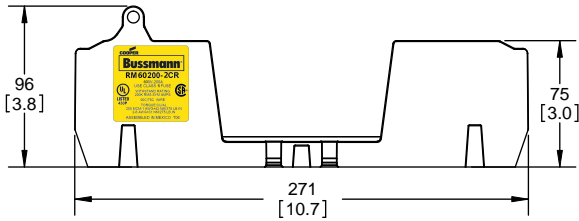
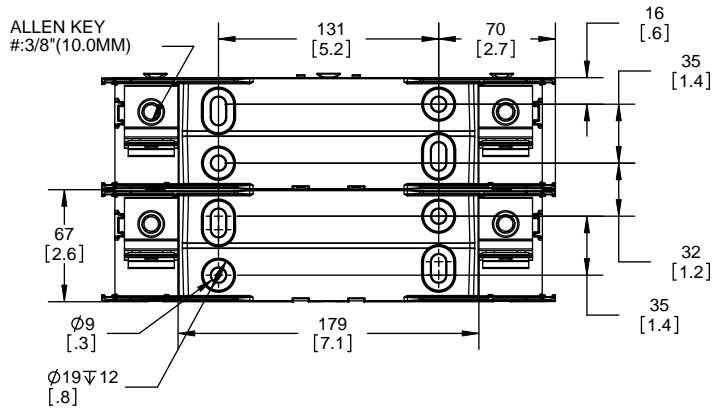

**COOPER Bussmann**  
St. Louis MO 63178

TITLE:  
**Class R fuse holder-CUST-600V**

SCALE: 1:1 SIZE: A3 SHEET: 5 OF 12

**RM60200-3CR**

**RM60200-3CR  
WITH CVR-RH-60200 INSTALLED**

**RM60200-3CR  
WITH CVRI-RH-60200 INSTALLED**

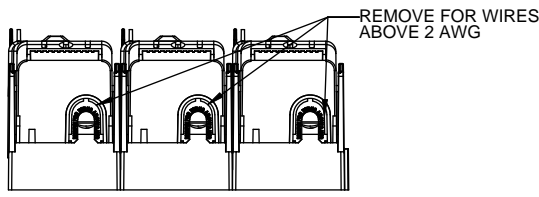
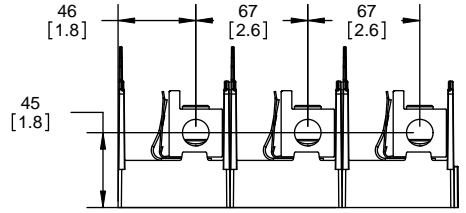
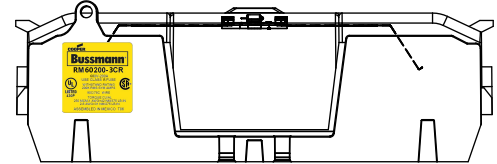
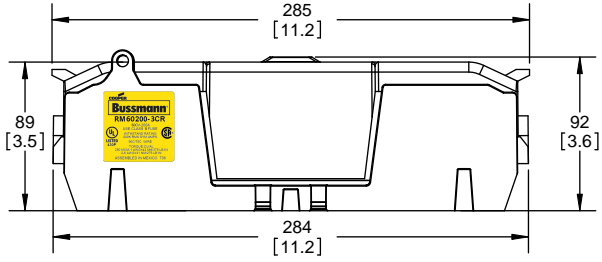
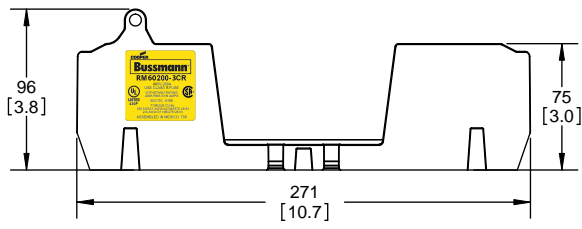
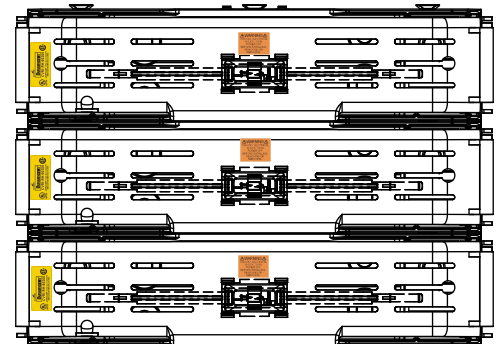
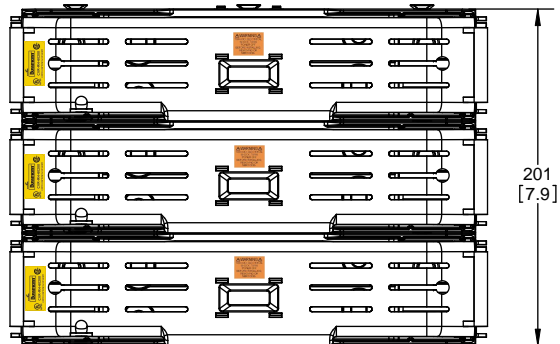
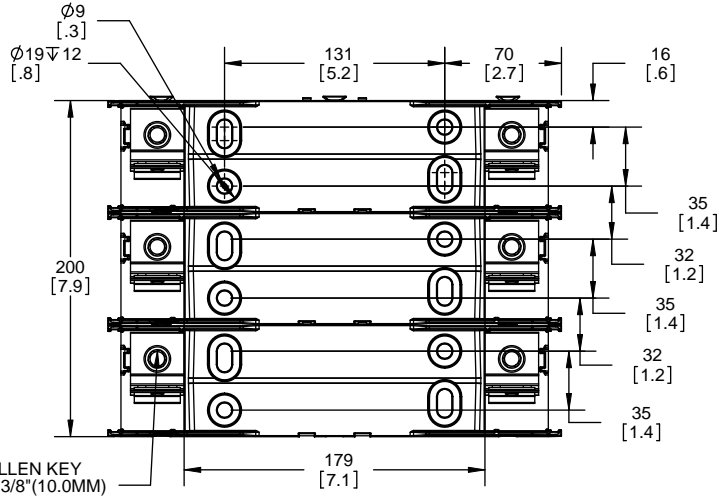

**COOPER Bussmann**  
St. Louis MO 63178

TITLE: **Class R fuse holder-CUST-600V**

SCALE: 1:1      SIZE: A3      SHEET: 6 OF 12

**RM60400-1CR**



**RM60400-1CR WITH CVR-RH-60400 INSTALLED**

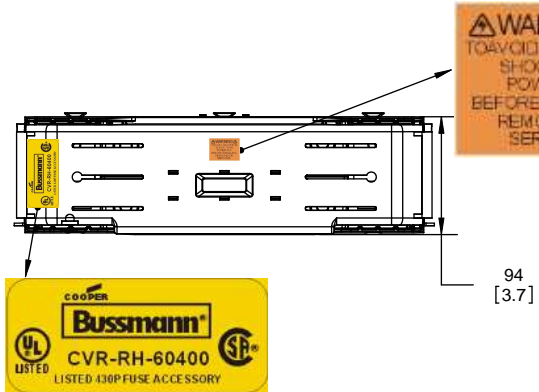

**RM60400-1CR WITH CVRI-RH-60400 INSTALLED**



**COOPER Bussmann RM60400-1CR**  
600V-400A  
USE CLASS R FUSE  
WITHSTAND RATING  
200K RMS SYM AMPS  
TORQUE CU/AL 75C WIRE  
CR 600KCMIL = 57 NM / 500 IN-LBS  
2 x 3/0 - 4 AWG = 57 NM / 500 IN-LBS  
CR 500KCMIL - 4 AWG = 51 NM / 450 IN-LBS  
ASSEMBLED IN MEXICO T06

**UL LISTED 430P**

**CVR-RH-60400**

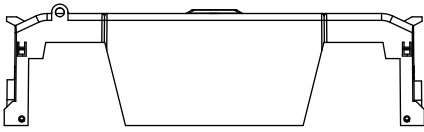

**CVRI-RH-60400**



CUT OPEN ALONG THIS DOTTED LINE FOR WIRES ABOVE 250 KCMIL

**COOPER Bussmann**  
St. Louis MO 63178

TITLE: **Class R fuse holder-CUST-600V**

SCALE: 1:1 SIZE: A3 SHEET: 7 OF 12

REVISIONS			DATE	ECN	BY
REV	ZONE	DESCRIPTION			

**RM60400-2CR**



**RM60400-2CR  
WITH CVR-RH-60400 INSTALLED**



**RM60400-2CR  
WITH CVRI-RH-60400 INSTALLED**



**COOPER Bussmann**  
St. Louis MO 63178

TITLE:  
**Class R fuse holder-CUST-600V**

SCALE: 1:1      SIZE: A3      SHEET: 8 OF 12

REVISIONS			DATE	ECN	BY
REV	ZONE	DESCRIPTION			

**RM60400-3CR**

**RM60400-3CR  
WITH CVR-RH-60400 INSTALLED**

**RM60400-3CR  
WITH CVRI-RH-60400 INSTALLED**

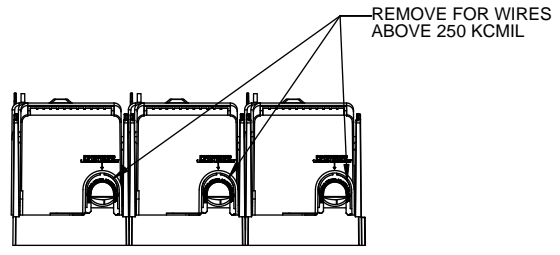
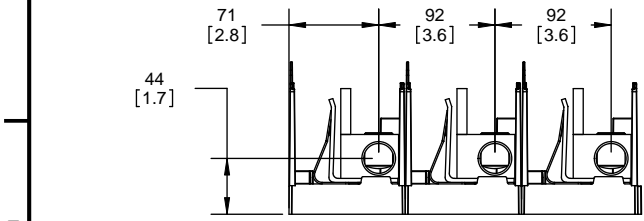
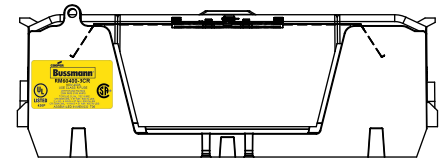
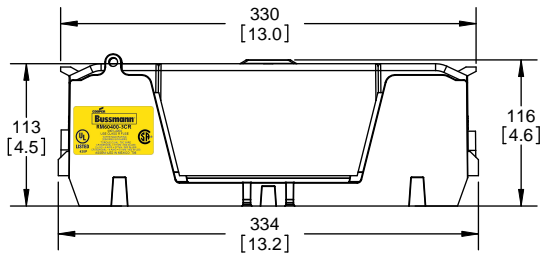
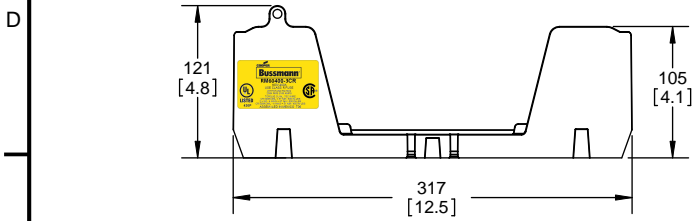
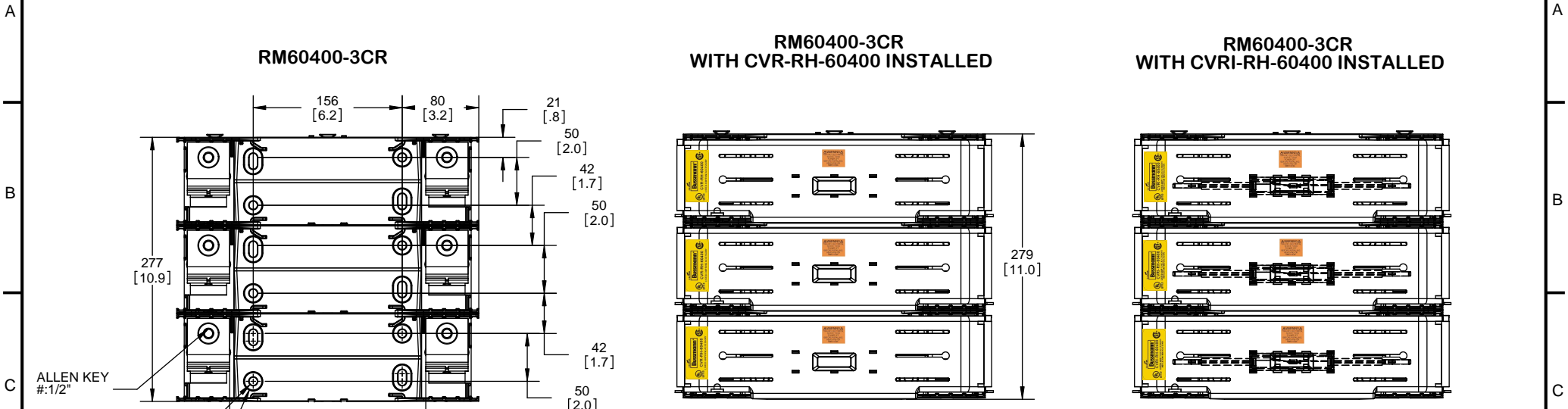

**COOPER Bussmann**  
St. Louis MO 63178

TITLE:  
**Class R fuse holder-CUST-600V**

SCALE: 1:1      SIZE: A3      SHEET: 9 OF 12

Drawing template A3 - Rev 05

**RM60600-1CR**

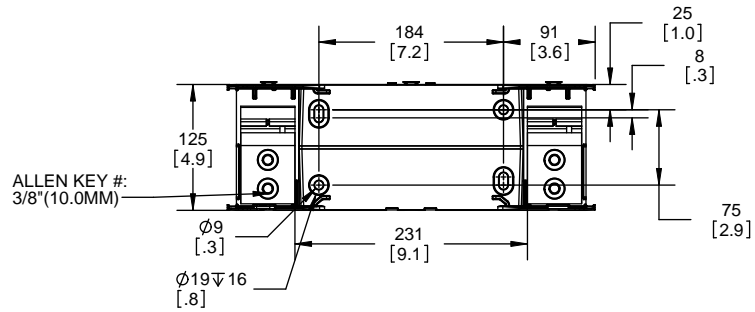

**RM60600-1CR WITH CVR-RH-60600 INSTALLED**

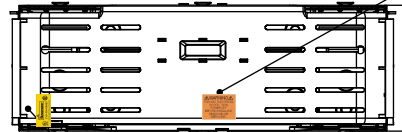

**RM60600-1CR WITH CVRI-RH-60600 INSTALLED**

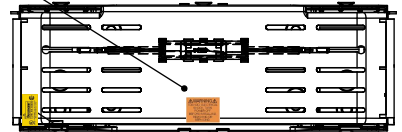

**WARNING**  
 TO AVOID ELECTRICAL SHOCK, TURN POWER OFF BEFORE INSTALLING, REMOVING OR SERVICING.

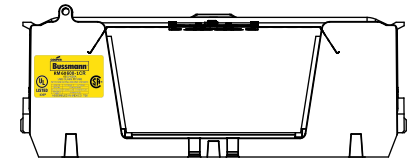
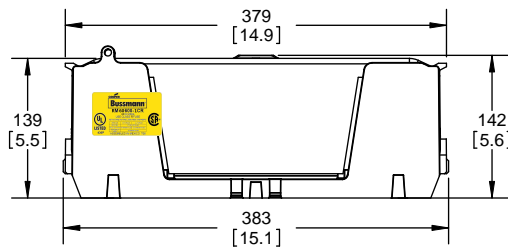
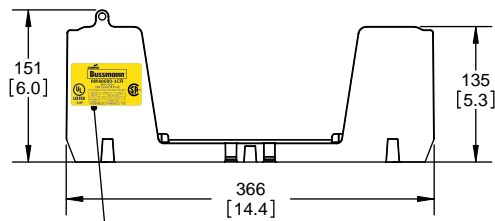

**CVR-RH-60600**

**CVRI-RH-60600**

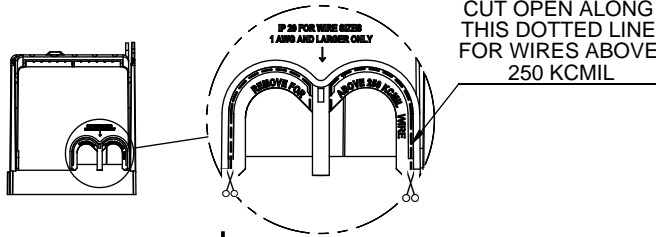
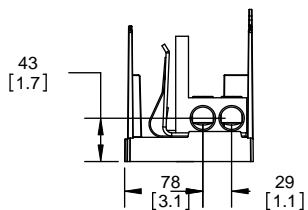
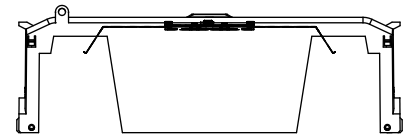
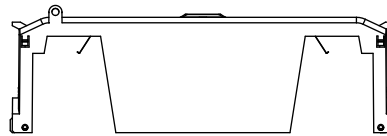

**COOPER Bussmann**  
 St. Louis MO 63178

TITLE:  
**Class R fuse holder-CUST-600V**

SCALE: 1:5 SIZE: A3 SHEET: 10 OF 12



DESIGN UNITS: METRIC (mm)  
UNLESS OTHERWISE SPECIFIED  
[INCHES]

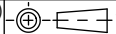

THIRD ANGLE PROJECTION

REVISIONS			DATE	ECN	BY
REV	ZONE	DESCRIPTION			

**RM60600-2CR**



**RM60600-2CR  
WITH CVR-RH-60600 INSTALLED**



**RM60600-2CR  
WITH CVRI-RH-60600 INSTALLED**

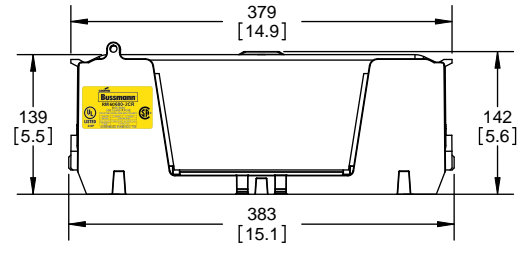

**COOPER Bussmann**  
St. Louis MO 63178

TITLE:  
**Class R fuse holder-CUST-600V**

SCALE: 1:5      SIZE: A3      SHEET: 11 OF 12

REVISIONS				DATE	ECN	BY
REV	ZONE	DESCRIPTION				

**RM60600-3CR**



**RM60600-3CR  
WITH CVR-RH-60600 INSTALLED**



**RM60600-3CR  
WITH CVRI-RH-60600 INSTALLED**



ALLEN KEY #:  
3/8" (10.0MM)

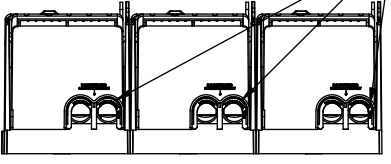
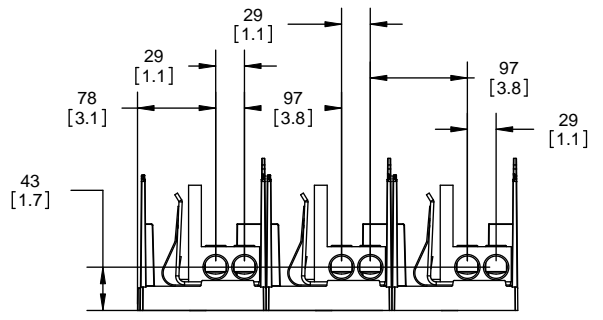
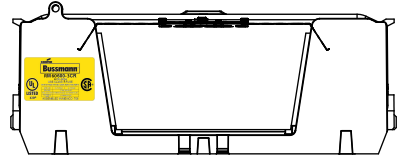
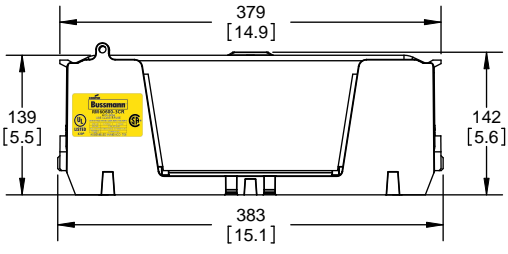
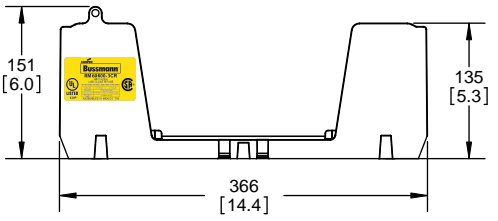

**COOPER Bussmann**  
St. Louis MO 63178

TITLE:  
**Class R fuse holder-CUST-600V**

SCALE: 1:5      SIZE: A3      SHEET: 12 OF 12