

Class R Fuseblocks Catalog Data

Catalog Number	Covers		Voltage	Current	Number of Poles	Label
	Class R	w/o Indication				
RM25100-1CR	CVR-RH-25100	CVRI-RH-25100	250	100	1	RM25100-1CR
RM25100-2CR					2	RM25100-2CR
RM25100-3CR					3	RM25100-3CR
RM25200-1CR	CVR-RH-25200	CVRI-RH-25200		200	1	RM25200-1CR
RM25200-2CR					2	RM25200-2CR
RM25200-3CR					3	RM25200-3CR
RM25400-1CR	CVR-RH-25400	CVRI-RH-25400		400	1	RM25400-1CR
RM25400-2CR					2	RM25400-2CR
RM25400-3CR					3	RM25400-3CR
RM25600-1CR	CVR-RH-25600	CVRI-RH-25600		600	1	RM25600-1CR
RM25600-2CR					2	RM25600-2CR
RM25600-3CR					3	RM25600-3CR

Catalog Number	Covers		Voltage	Current	Number of Poles	Label
	Class R	w/o Indication				
RM60100-1CR	CVR-RH-60100	CVRI-RH-60100	600	100	1	RM60100-1CR
RM60100-2CR					2	RM60100-2CR
RM60100-3CR					3	RM60100-3CR
RM60200-1CR	CVR-RH-60200	CVRI-RH-60200		200	1	RM60200-1CR
RM60200-2CR					2	RM60200-2CR
RM60200-3CR					3	RM60200-3CR
RM60400-1CR	CVR-RH-60400	CVRI-RH-60400		400	1	RM60400-1CR
RM60400-2CR					2	RM60400-2CR
RM60400-3CR					3	RM60400-3CR
RM60600-1CR	CVR-RH-60600	CVRI-RH-60600		600	1	RM60600-1CR
RM60600-2CR					2	RM60600-2CR
RM60600-3CR					3	RM60600-3CR

COOPER Bussmann
St. Louis MO 63178

TITLE:
Class R fuse holder-CUST

SCALE: 1:1 SIZE: A3 SHEET: 1 OF 14



PUSH DOWN



LIFT UP

LIFT UP, THEN ROTATE OVER



COOPER Bussmann
St. Louis MO 63178

TITLE:
Class R fuse holder-CUST

SCALE: 1:2 SIZE: A3 SHEET: 2 OF 14

www.Bussmann.com

RM25100-1CR

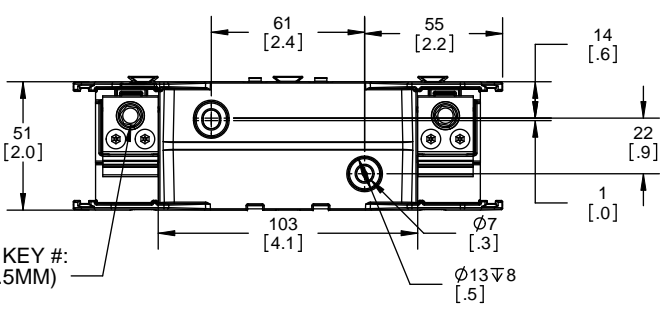

ALLEN KEY #: 3/16" (5.5MM)

RM25100-1CR WITH CVR-RH-25100 INSTALLED

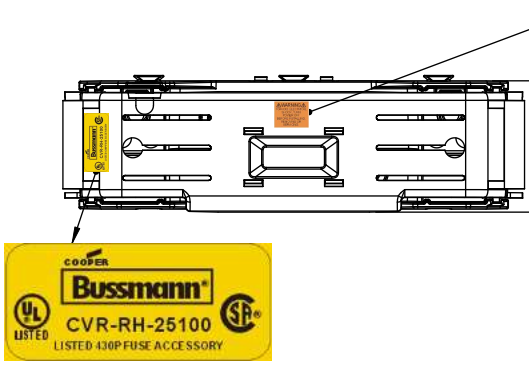

RM25100-1CR WITH CVRI-RH-25100 INSTALLED

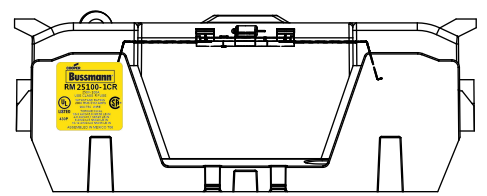
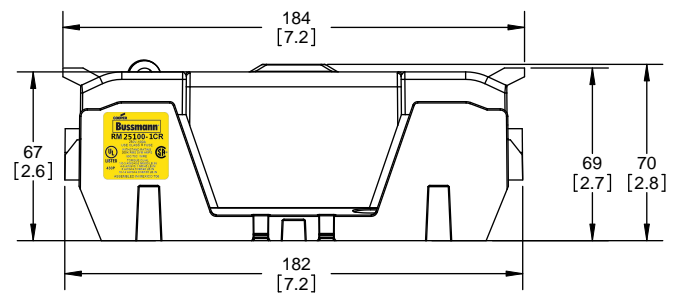
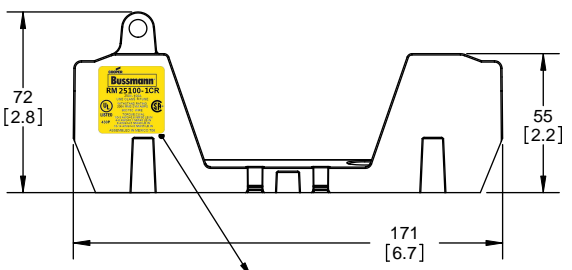
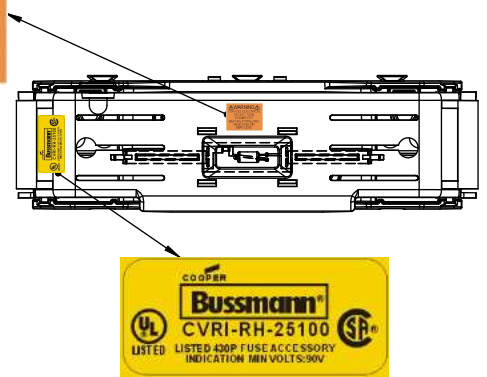

CVR-RH-25100

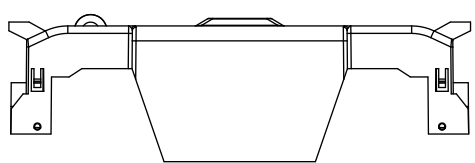

CVRI-RH-25100

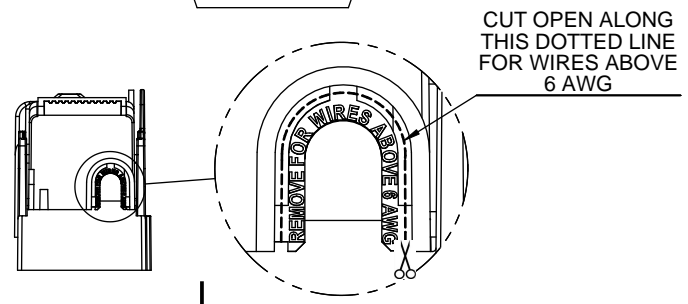
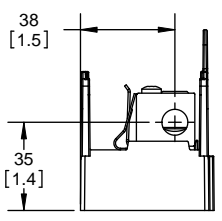
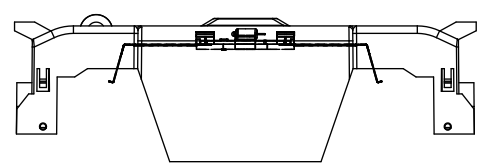

COOPER Bussmann
St. Louis MO 63178

TITLE: **Class R fuse holder-CUST-250V**

SCALE: 1:1 SIZE: A3 SHEET: 3 OF 14

DESIGN UNITS: METRIC (mm)
UNLESS OTHERWISE SPECIFIED
[INCHES]



THIRD ANGLE PROJECTION

RM25100-2CR



**RM25100-2CR
WITH CVR-RH-25100 INSTALLED**



**RM25100-2CR
WITH CVRI-RH-25100 INSTALLED**



COOPER Bussmann
St. Louis MO 63178

TITLE:
Class R fuse holder-CUST-250V

SCALE: 1:1 SIZE: A3 SHEET: 4 OF 14

DESIGN UNITS: METRIC (mm)
UNLESS OTHERWISE SPECIFIED [INCHES]



THIRD ANGLE PROJECTION

RM25100-3CR



**RM25100-3CR
WITH CVR-RH-25100 INSTALLED**

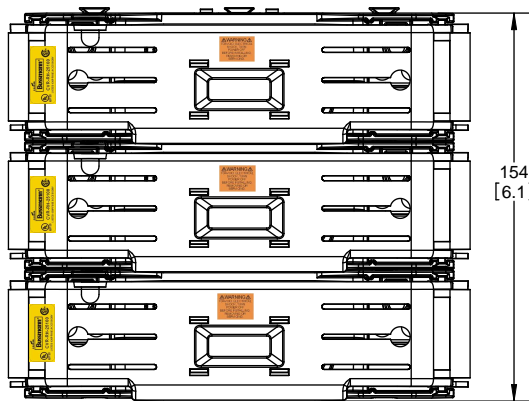

**RM25100-3CR
WITH CVRI-RH-25100 INSTALLED**

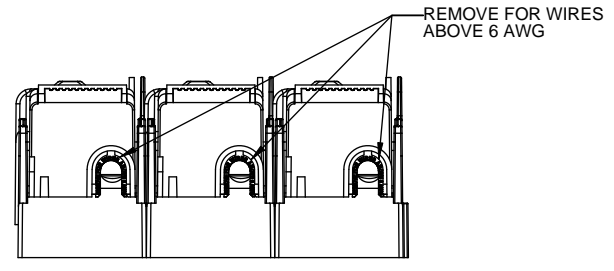
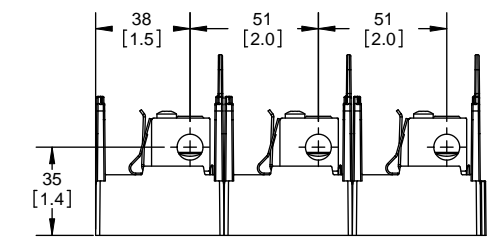
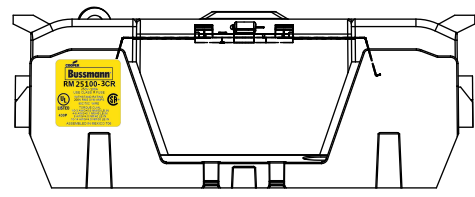
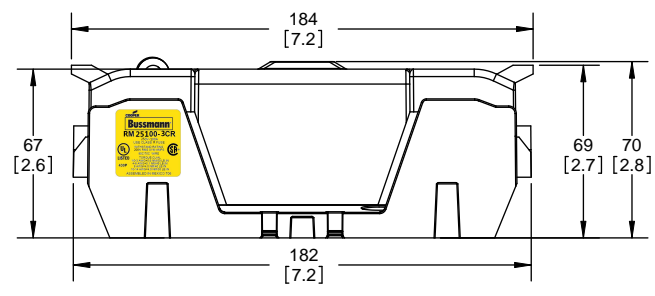
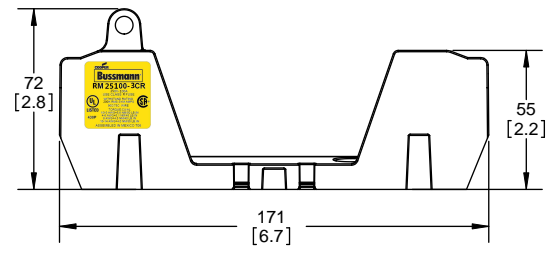
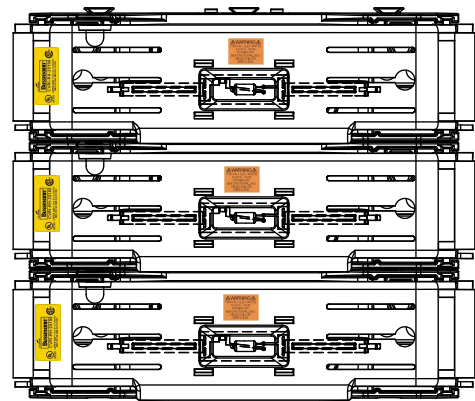

COOPER Bussmann
St. Louis MO 63178

TITLE:
Class R fuse holder-CUST-250V

SCALE: 1:1 SIZE: A3 SHEET: 5 OF 14

RM25200-1CR



RM25200-1CR WITH CVR-RH-25200 INSTALLED

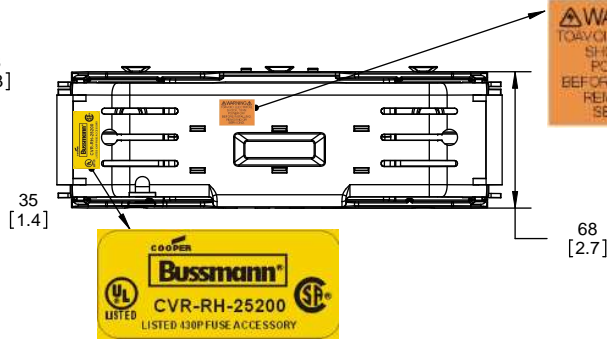

RM25200-1CR WITH CVRI-RH-25200 INSTALLED

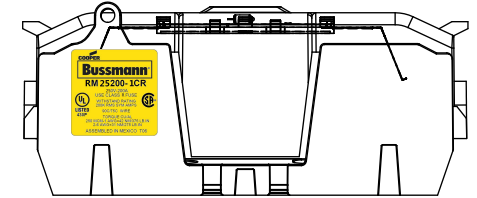
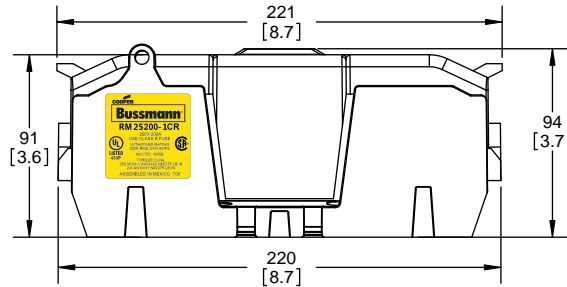
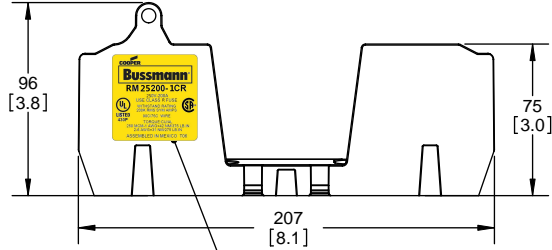
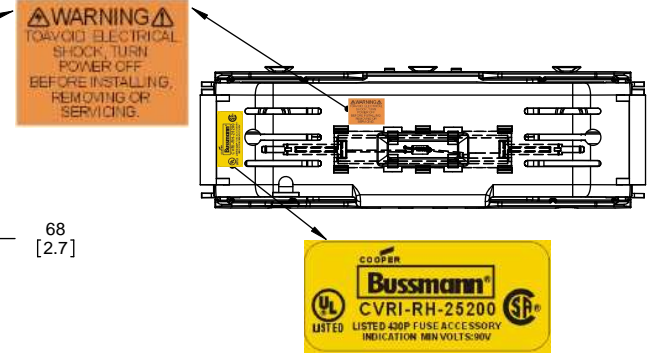

COOPER Bussmann
RM 25200-1CR

250V-200A
 USE CLASS R FUSE
 WITHSTAND RATING
 200K RMS SYM AMPS
 90C/75C WIRE
 TORQUE: CU/AL
 250 MCM-1 AWG=42 NM/375 LB.IN
 2-6 AWG=31 NM/275 LB.IN
 ASSEMBLED IN MEXICO T06

UL LISTED 430P

CVR-RH-25200

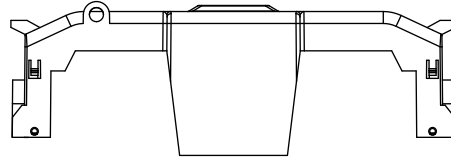

CVRI-RH-25200

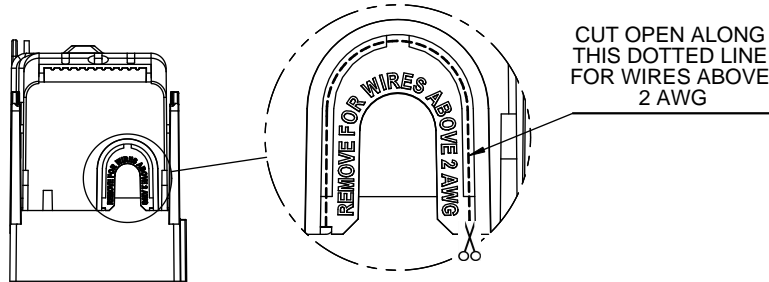
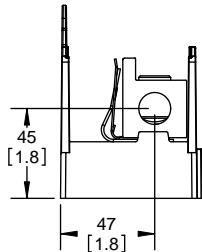
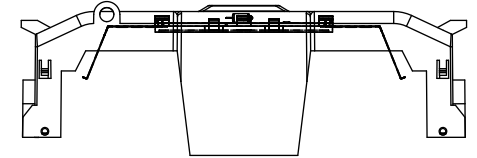

COOPER Bussmann
 St. Louis MO 63178

TITLE:
Class R fuse holder-CUST-250V

SCALE: 1:1 SIZE: A3 SHEET: 6 OF 14

DESIGN UNITS: METRIC (mm)
UNLESS OTHERWISE SPECIFIED
[INCHES]



THIRD ANGLE PROJECTION

RM25200-2CR

**RM25200-2CR
WITH CVR-RH-25200 INSTALLED**

**RM25200-2CR
WITH CVRI-RH-25200 INSTALLED**



COOPER Bussmann
St. Louis MO 63178

TITLE:
Class R fuse holder-CUST-250V

SCALE: 1:1 SIZE: A3 SHEET: 7 OF 14

DESIGN UNITS: METRIC (mm)
UNLESS OTHERWISE SPECIFIED [INCHES]



THIRD ANGLE PROJECTION

RM25200-3CR

**RM25200-3CR
WITH CVR-RH-25200 INSTALLED**

**RM25200-3CR
WITH CVRI-RH-25200 INSTALLED**

ALLEN KEY #:
3/8" (10.0MM)

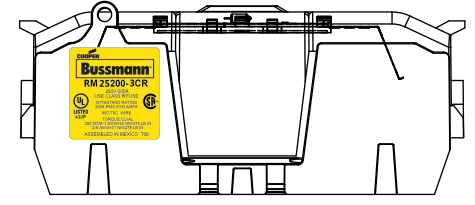

COOPER Bussmann
St. Louis MO 63178

TITLE:
Class R fuse holder-CUST-250V

SCALE: 1:1 SIZE: A3 SHEET: 8 OF 14

DESIGN UNITS: METRIC (mm)
UNLESS OTHERWISE SPECIFIED
[INCHES]

THIRD ANGLE PROJECTION

RM25400-1CR

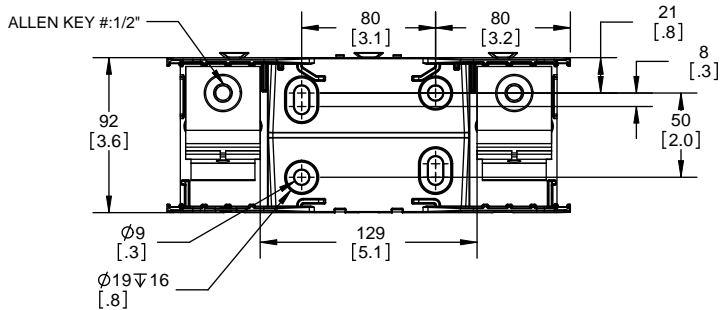

**RM25400-1CR
WITH CVR-RH-25400 INSTALLED**

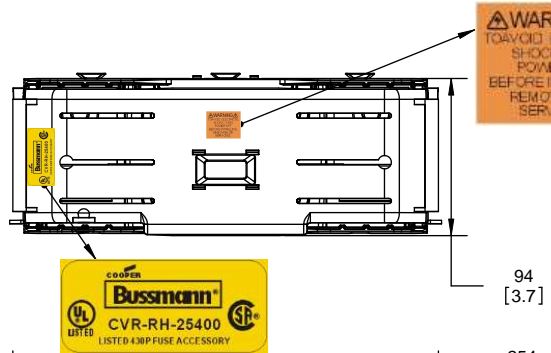

**RM25400-1CR
WITH CVRI-RH-25400 INSTALLED**

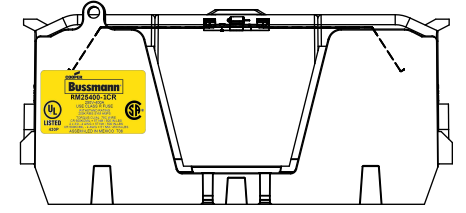
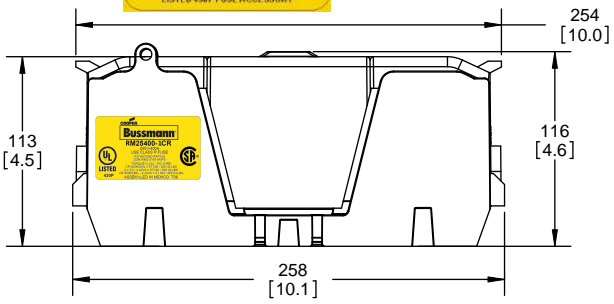
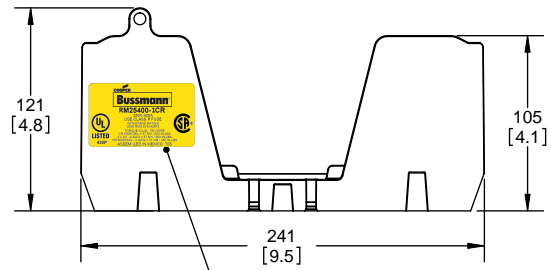
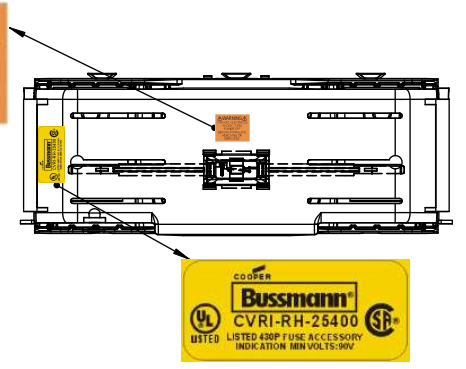

CVR-RH-25400

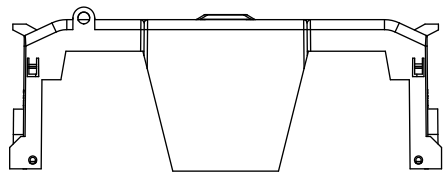

CVRI-RH-25400

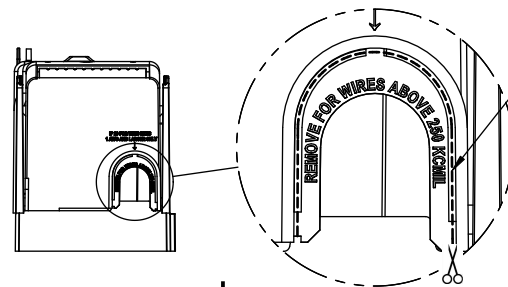
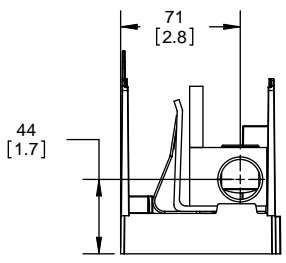
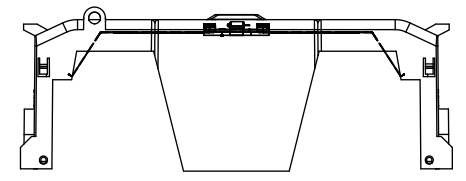

COOPER Bussmann
St. Louis MO 63178

TITLE:
Class R fuse holder-CUST-250V

SCALE: 1:1 SIZE: A3 SHEET: 9 OF 14

DESIGN UNITS: METRIC (mm)
UNLESS OTHERWISE SPECIFIED [INCHES]



THIRD ANGLE PROJECTION

RM25400-2CR



**RM25400-2CR
WITH CVR-RH-25400 INSTALLED**



**RM25400-2CR
WITH CVRI-RH-25400 INSTALLED**

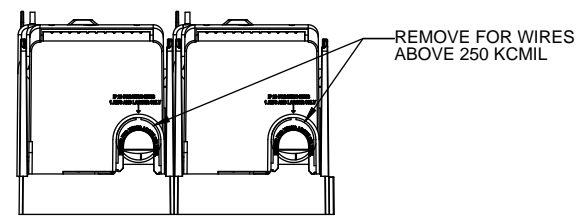

COOPER Bussmann
St. Louis MO 63178

TITLE:
Class R fuse holder-CUST-250V

SCALE: 1:1 SIZE: A3 SHEET: 10 OF 14

DESIGN UNITS: METRIC (mm)
UNLESS OTHERWISE SPECIFIED
[INCHES]



THIRD ANGLE PROJECTION

RM25400-3CR

**RM25400-3CR
WITH CVR-RH-25400 INSTALLED**

**RM25400-3CR
WITH CVRI-RH-25400 INSTALLED**

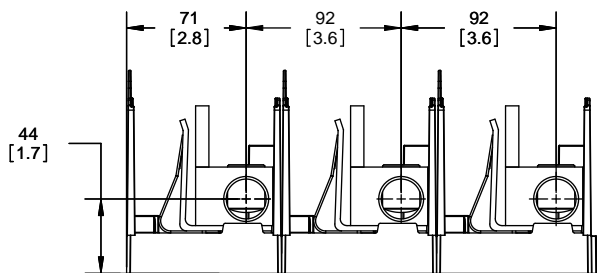
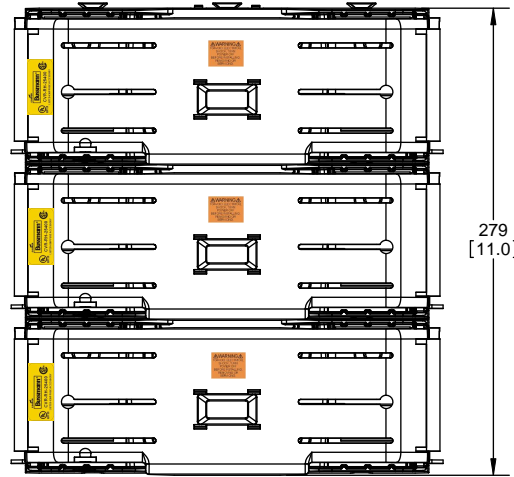
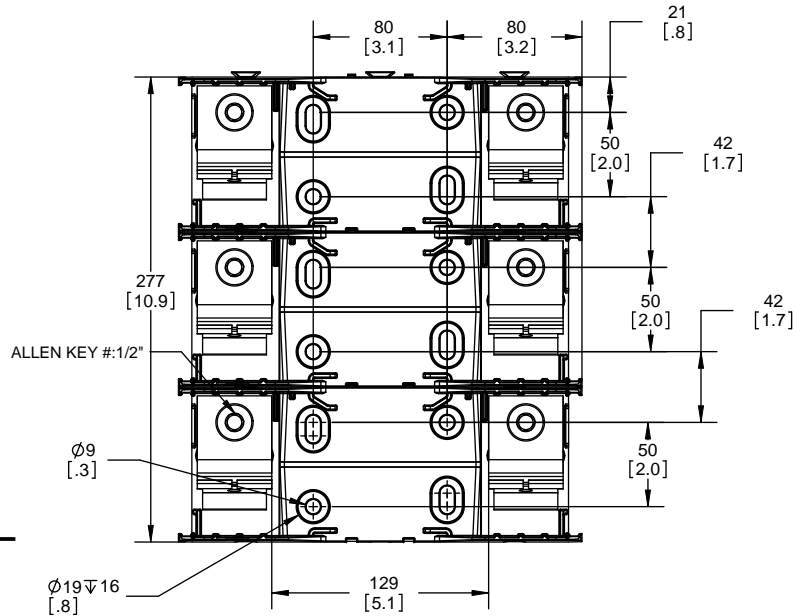

COOPER Bussmann
St. Louis MO 63178

TITLE:
Class R fuse holder-CUST-250V

SCALE: 1:1 SIZE: A3 SHEET: 11 OF 14

DESIGN UNITS: METRIC (mm) UNLESS OTHERWISE SPECIFIED
 THIRD ANGLE PROJECTION

RM25600-1CR

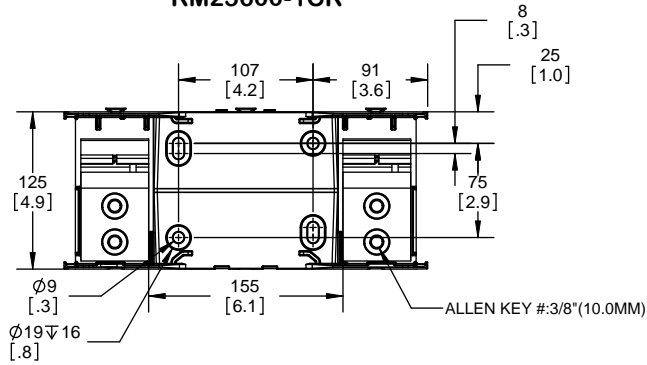

RM25600-1CR WITH CVR-RH-25600 INSTALLED

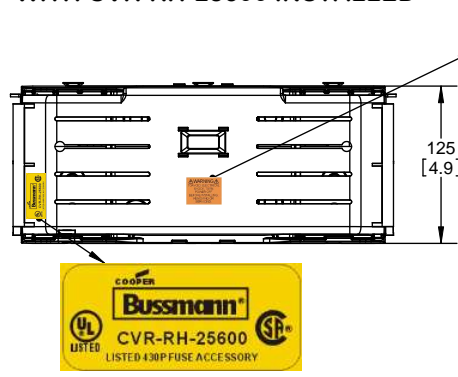

RM25600-1CR WITH CVRI-RH-25600 INSTALLED

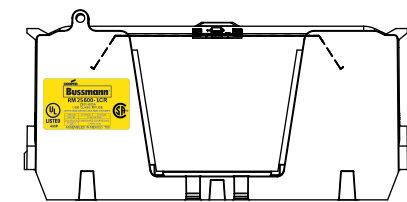
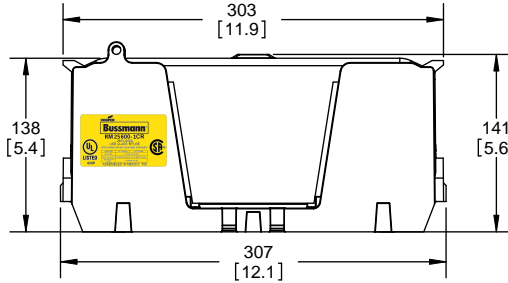
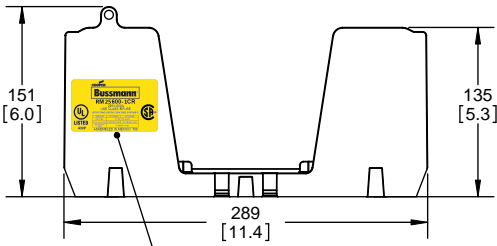
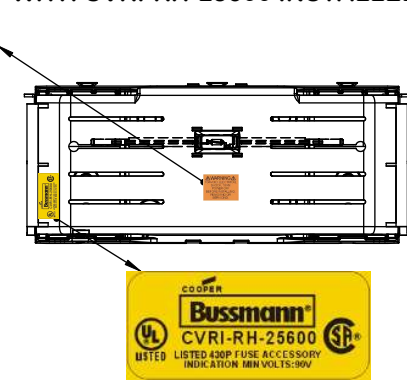

CVR-RH-25600

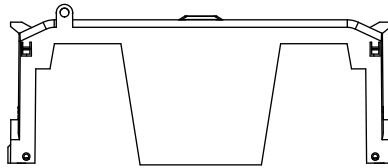

CVRI-RH-25600

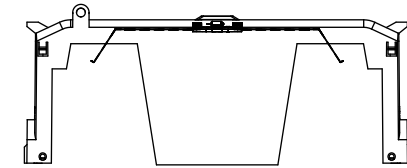

WIRE SIZE	CUT TORQUE	AL TORQUE
600 KCMIL	87 NM (62 IN-LBS)	
DUAL 304 AWG	37 NM (26 IN-LBS)	33.9 NM (24 IN-LBS)
100 KCMIL	51 NM (37 IN-LBS)	51 NM (37 IN-LBS)

ASSEMBLED IN MEXICO T06

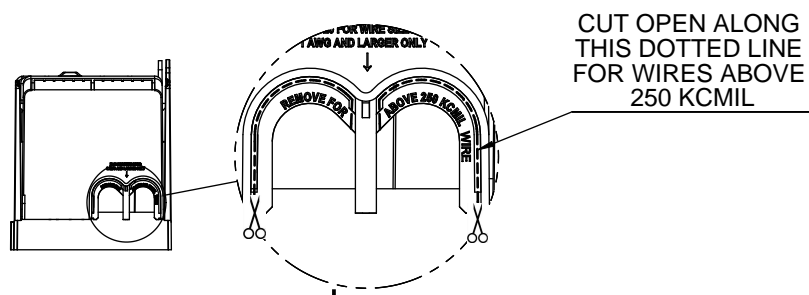
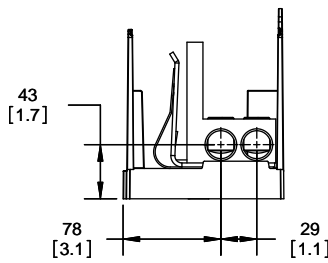

COOPER Bussmann
 St. Louis MO 63178

TITLE: **Class R fuse holder-CUST-250V**

SCALE: 1:1 SIZE: A3 SHEET: 12 OF 14

DESIGN UNITS: METRIC (mm)
UNLESS OTHERWISE SPECIFIED
[INCHES]



THIRD ANGLE PROJECTION

RM25600-2CR

**RM25600-2CR
WITH CVR-RH-25600 INSTALLED**

**RM25600-2CR
WITH CVRI-RH-25600 INSTALLED**



COOPER Bussmann
St. Louis MO 63178

TITLE:
Class R fuse holder-CUST-250V

SCALE: 1:1 SIZE: A3 SHEET: 13 OF 14

DESIGN UNITS: METRIC (mm)
UNLESS OTHERWISE SPECIFIED
[INCHES]



THIRD ANGLE PROJECTION

RM25600-3CR



**RM25600-3CR
WITH CVR-RH-25600 INSTALLED**

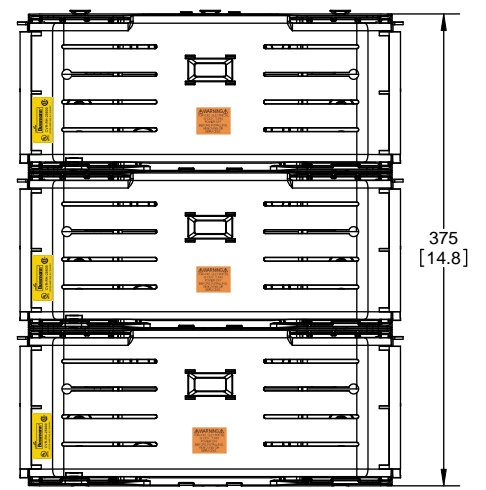

**RM25600-3CR
WITH CVRI-RH-25600 INSTALLED**

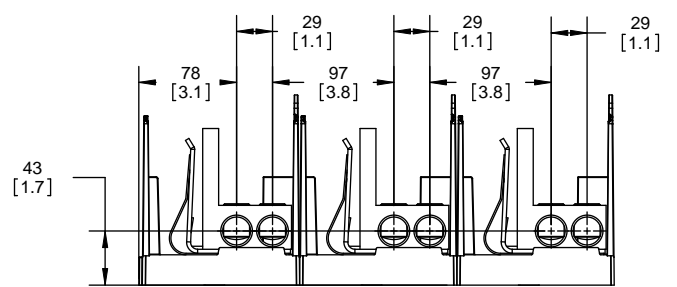
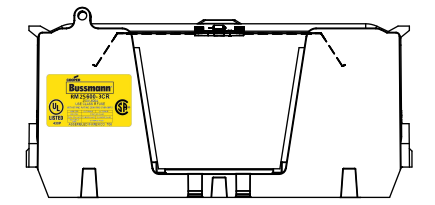
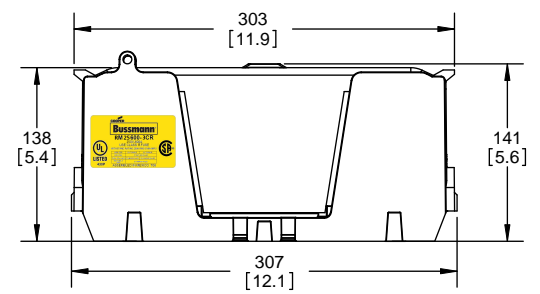
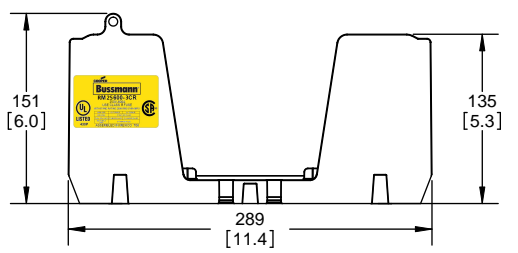
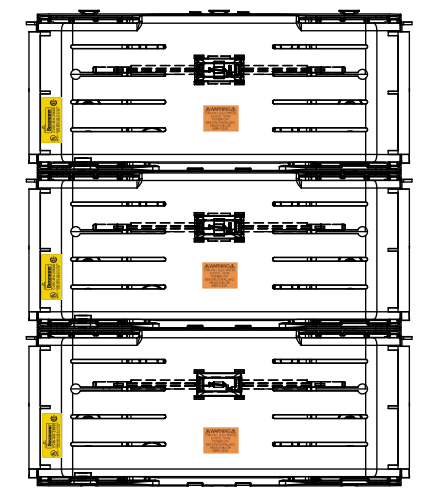

COOPER Bussmann
St. Louis MO 63178

TITLE:
Class R fuse holder-CUST-250V

SCALE: 1:1 SIZE: A3 SHEET: 14 OF 14

REVISONS			DATE	ECN	BY
REV	ZONE	DESCRIPTION			

RM60100-1CR

RM60100-1CR WITH CVR-RH-60100 INSTALLED

RM60100-1CR WITH CVRI-RH-60100 INSTALLED

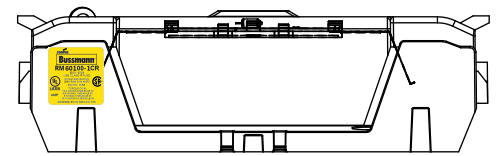
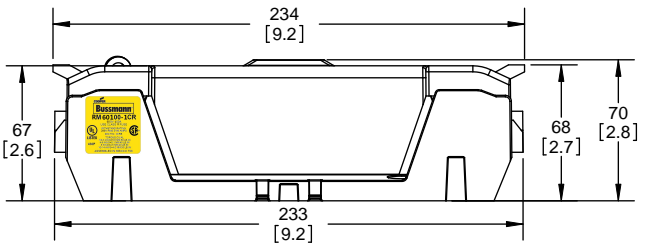
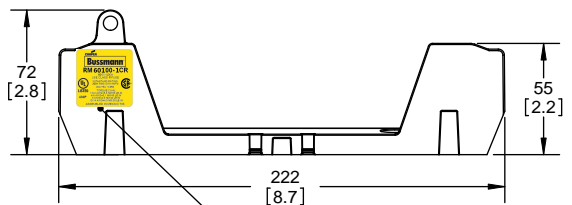
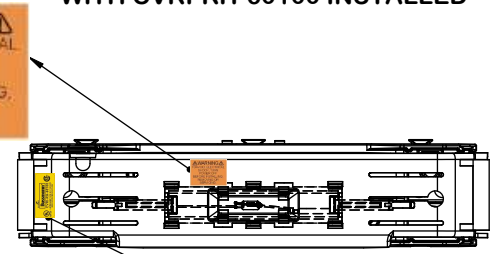
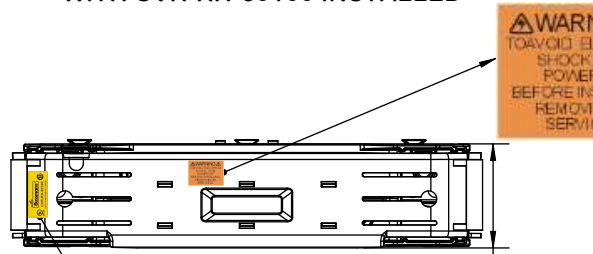
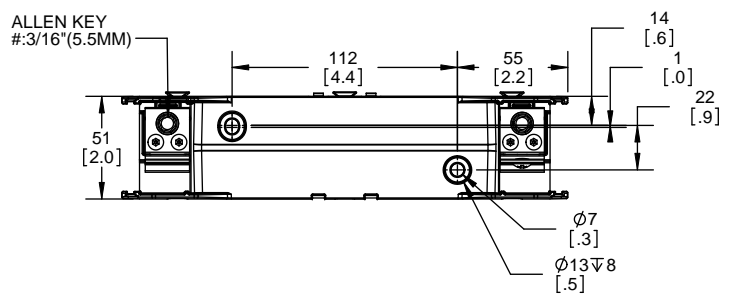

CVR-RH-60100

CVRI-RH-60100

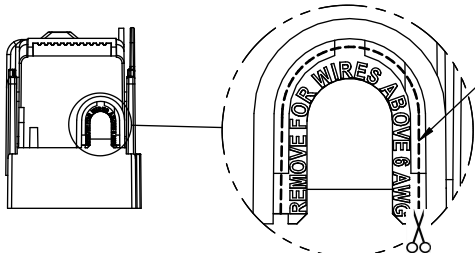
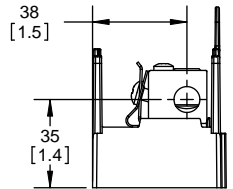
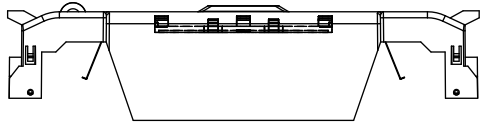
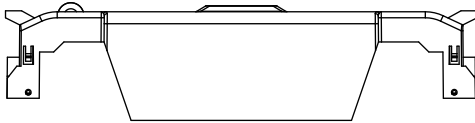

CUT OPEN ALONG THIS DOTTED LINE FOR WIRES ABOVE 6 AWG

COOPER Bussmann
St. Louis MO 63178

TITLE: **Class R fuse holder-CUST-600V**

SCALE: 1:1 SIZE: A3 SHEET: 1 OF 12

REVISIONS					
REV	ZONE	DESCRIPTION	DATE	ECN	BY

RM60100-2CR

**RM60100-2CR
WITH CVR-RH-60100 INSTALLED**

**RM60100-2CR
WITH CVRI-RH-60100 INSTALLED**

ALLEN KEY
#3/16" (5.5MM)



COOPER Bussmann
St. Louis MO 63178

TITLE:
Class R fuse holder-CUST-600V

SCALE: 1:1 SIZE: A3 SHEET: 2 OF 12

RM60100-3CR

RM60100-3CR WITH CVR-RH-60100 INSTALLED

RM60100-3CR WITH CVRI-RH-60100 INSTALLED

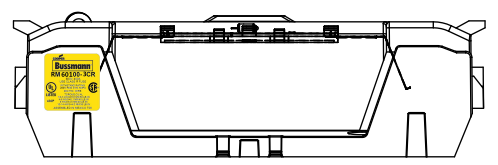
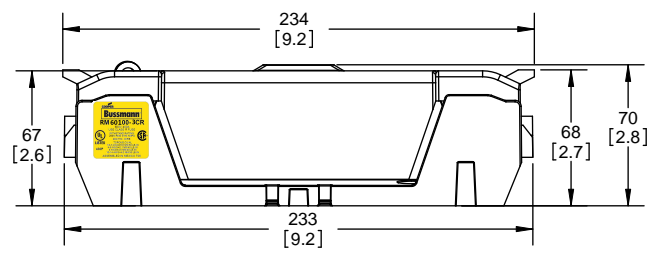

COOPER Bussmann
St. Louis MO 63178

TITLE:
Class R fuse holder-CUST-600V

SCALE: 1:1 SIZE: A3 SHEET: 3 OF 12

REVISIONS				DATE	ECN	BY
REV	ZONE	DESCRIPTION				

RM60200-1CR

RM60200-1CR WITH CVR-RH-60200 INSTALLED

RM60200-1CR WITH CVRI-RH-60200 INSTALLED

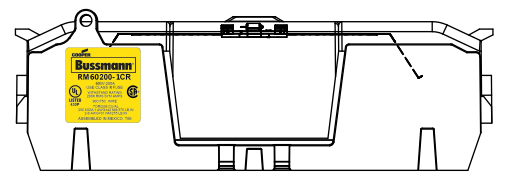
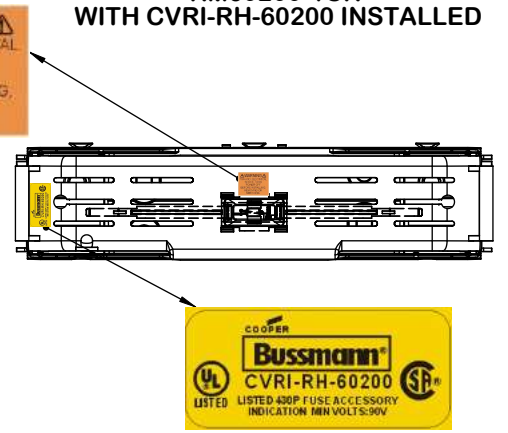

CVR-RH-60200

CVRI-RH-60200



COOPER Bussmann
St. Louis MO 63178

TITLE: **Class R fuse holder-CUST-600V**

SCALE: 1:1 SIZE: A3 SHEET: 4 OF 12

RM60200-2CR

**RM60200-2CR
WITH CVR-RH-60200 INSTALLED**

**RM60200-2CR
WITH CVRI-RH-60200 INSTALLED**

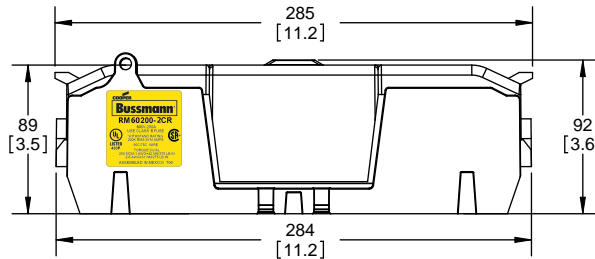
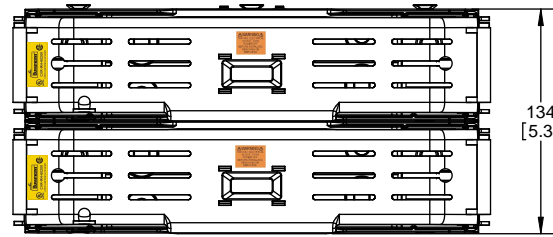

COOPER Bussmann
St. Louis MO 63178

TITLE:
Class R fuse holder-CUST-600V

SCALE: 1:1 SIZE: A3 SHEET: 5 OF 12

RM60200-3CR

**RM60200-3CR
WITH CVR-RH-60200 INSTALLED**

**RM60200-3CR
WITH CVRI-RH-60200 INSTALLED**

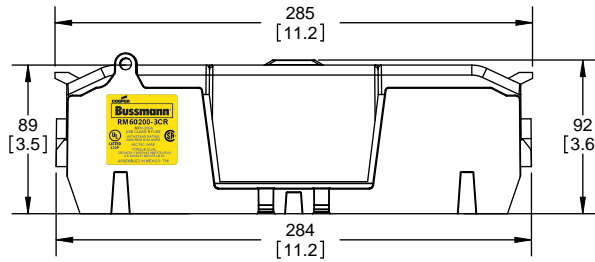
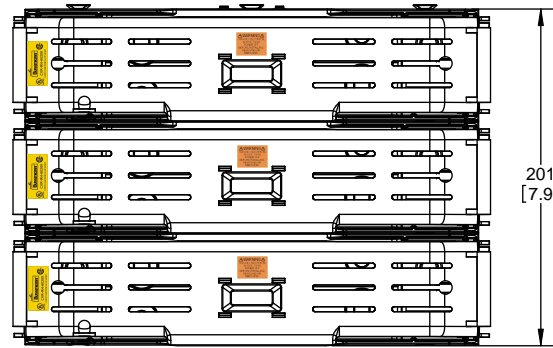

COOPER Bussmann
St. Louis MO 63178

TITLE: **Class R fuse holder-CUST-600V**

SCALE: 1:1 SIZE: A3 SHEET: 6 OF 12

RM60400-1CR



RM60400-1CR WITH CVR-RH-60400 INSTALLED



RM60400-1CR WITH CVRI-RH-60400 INSTALLED



COOPER Bussmann RM60400-1CR
600V-400A
USE CLASS R FUSE
WITHSTAND RATING
200K RMS SYM AMPS
TORQUE CU/AL 75C WIRE
CR 600KCMIL = 57 NM / 500 IN-LBS
2 x 3/0 - 4 AWG = 57 Nm / 500 IN-LBS
CR 500KCMIL - 4 AWG = 51 Nm / 450 IN-LBS
ASSEMBLED IN MEXICO T06

UL LISTED 430P

CVR-RH-60400

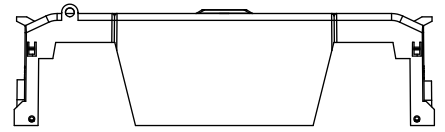

CVRI-RH-60400



CUT OPEN ALONG THIS DOTTED LINE FOR WIRES ABOVE 250 KCMIL

COOPER Bussmann
St. Louis MO 63178

TITLE: **Class R fuse holder-CUST-600V**

SCALE: 1:1 SIZE: A3 SHEET: 7 OF 12

REVISIONS			DATE	ECN	BY
REV	ZONE	DESCRIPTION			

RM60400-2CR



**RM60400-2CR
WITH CVR-RH-60400 INSTALLED**



**RM60400-2CR
WITH CVRI-RH-60400 INSTALLED**



COOPER Bussmann
St. Louis MO 63178

TITLE:
Class R fuse holder-CUST-600V

SCALE: 1:1 SIZE: A3 SHEET: 8 OF 12

DESIGN UNITS: METRIC (mm)
UNLESS OTHERWISE SPECIFIED
[INCHES]



THIRD ANGLE PROJECTION

REVISIONS			DATE	ECN	BY
REV	ZONE	DESCRIPTION			

RM60400-3CR

**RM60400-3CR
WITH CVR-RH-60400 INSTALLED**

**RM60400-3CR
WITH CVRI-RH-60400 INSTALLED**



COOPER Bussmann
St. Louis MO 63178

TITLE:
Class R fuse holder-CUST-600V

SCALE: 1:1 SIZE: A3 SHEET: 9 OF 12

RM60600-1CR

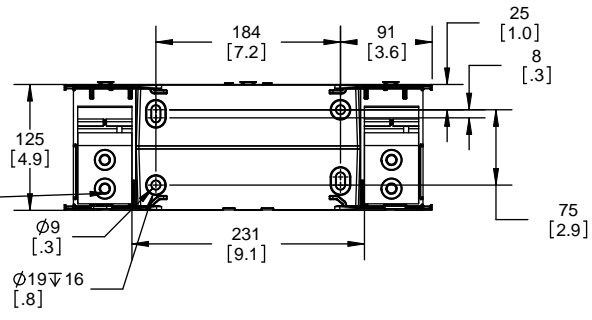

ALLEN KEY #: 3/8\"/>

RM60600-1CR WITH CVR-RH-60600 INSTALLED

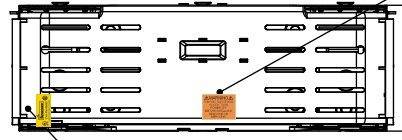

RM60600-1CR WITH CVRI-RH-60600 INSTALLED

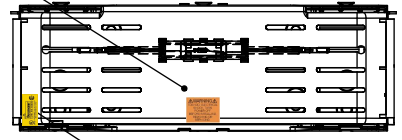

WARNING
 TO AVOID ELECTRICAL SHOCK, TURN POWER OFF BEFORE INSTALLING, REMOVING OR SERVICING.

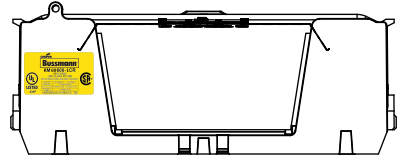
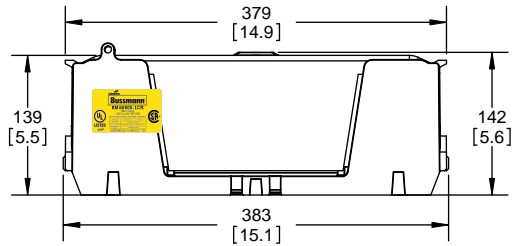
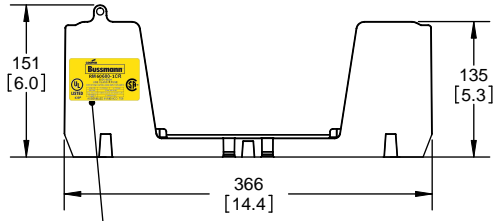

CVR-RH-60600

CVRI-RH-60600

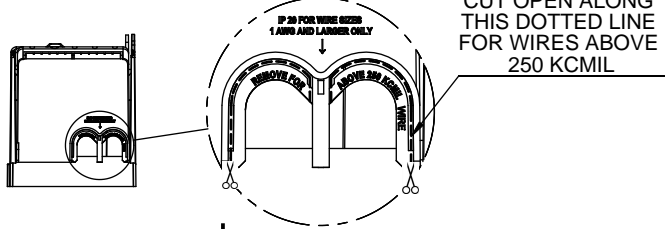
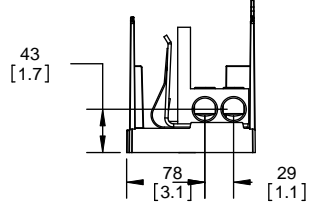
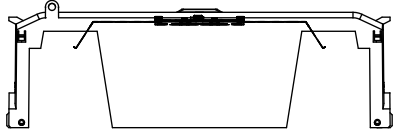
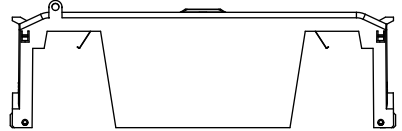

COOPER Bussmann
 St. Louis MO 63178

TITLE: **Class R fuse holder-CUST-600V**

SCALE: 1:5 SIZE: A3 SHEET: 10 OF 12

REVISIONS			DATE	ECN	BY
REV	ZONE	DESCRIPTION			

RM60600-2CR



**RM60600-2CR
WITH CVR-RH-60600 INSTALLED**



**RM60600-2CR
WITH CVRI-RH-60600 INSTALLED**



COOPER Bussmann
St. Louis MO 63178

TITLE:
Class R fuse holder-CUST-600V

SCALE: 1:5 SIZE: A3 SHEET: 11 OF 12

REVISIONS				DATE	ECN	BY
REV	ZONE	DESCRIPTION				

RM60600-3CR

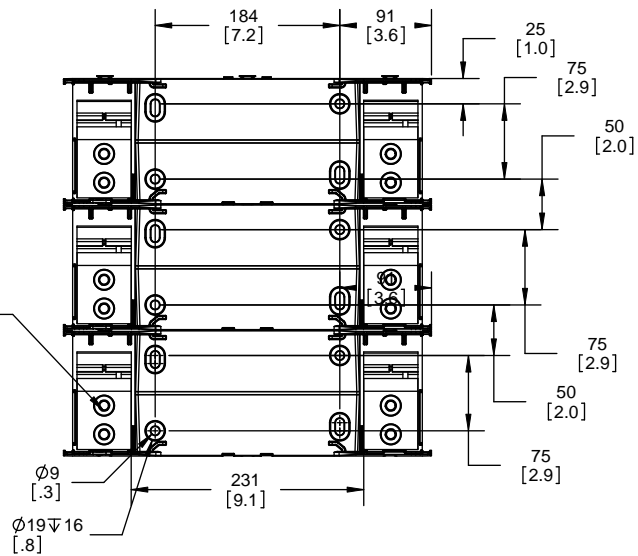

**RM60600-3CR
WITH CVR-RH-60600 INSTALLED**

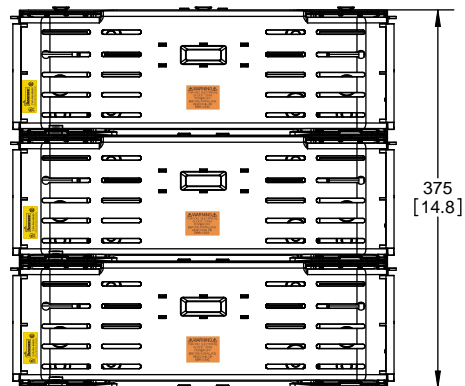

**RM60600-3CR
WITH CVRI-RH-60600 INSTALLED**

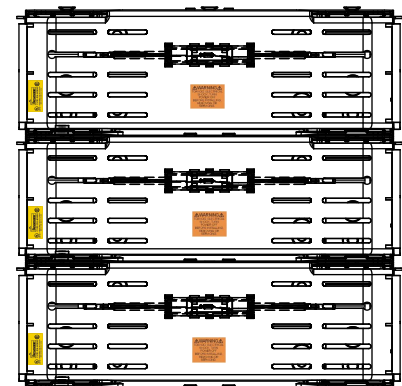

ALLEN KEY #:
3/8" (10.0MM)

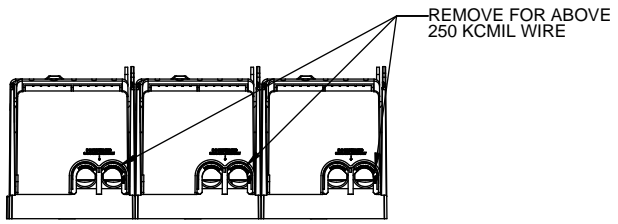
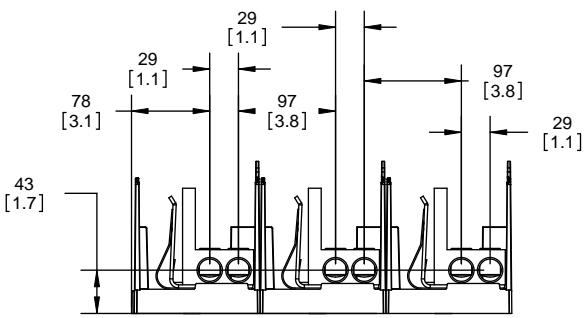
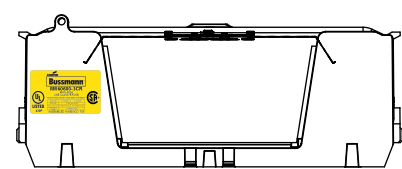
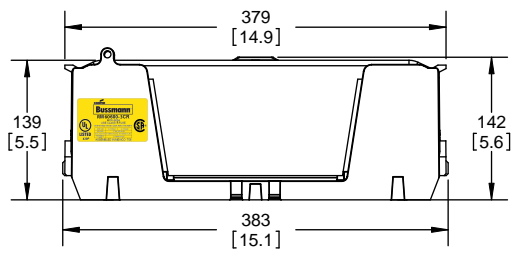
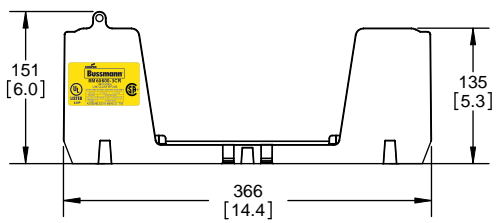

COOPER Bussmann
St. Louis MO 63178

TITLE:
Class R fuse holder-CUST-600V

SCALE: 1:5 SIZE: A3 SHEET: 12 OF 12