

Class R Fuseblocks Catalog Data

| Catalog Number | Covers | | Voltage | Current | Number of Poles | Label |
|----------------|--------------|----------------|---------|---------|-----------------|-------------|
| | Class R | w/o Indication | | | | |
| RM25100-1CR | CVR-RH-25100 | CVRI-RH-25100 | 250 | 100 | 1 | RM25100-1CR |
| RM25100-2CR | | | | | 2 | RM25100-2CR |
| RM25100-3CR | | | | | 3 | RM25100-3CR |
| RM25200-1CR | CVR-RH-25200 | CVRI-RH-25200 | | 200 | 1 | RM25200-1CR |
| RM25200-2CR | | | | | 2 | RM25200-2CR |
| RM25200-3CR | | | | | 3 | RM25200-3CR |
| RM25400-1CR | CVR-RH-25400 | CVRI-RH-25400 | | 400 | 1 | RM25400-1CR |
| RM25400-2CR | | | | | 2 | RM25400-2CR |
| RM25400-3CR | | | | | 3 | RM25400-3CR |
| RM25600-1CR | CVR-RH-25600 | CVRI-RH-25600 | | 600 | 1 | RM25600-1CR |
| RM25600-2CR | | | | | 2 | RM25600-2CR |
| RM25600-3CR | | | | | 3 | RM25600-3CR |

| Catalog Number | Covers | | Voltage | Current | Number of Poles | Label |
|----------------|--------------|----------------|---------|---------|-----------------|-------------|
| | Class R | w/o Indication | | | | |
| RM60100-1CR | CVR-RH-60100 | CVRI-RH-60100 | 600 | 100 | 1 | RM60100-1CR |
| RM60100-2CR | | | | | 2 | RM60100-2CR |
| RM60100-3CR | | | | | 3 | RM60100-3CR |
| RM60200-1CR | CVR-RH-60200 | CVRI-RH-60200 | | 200 | 1 | RM60200-1CR |
| RM60200-2CR | | | | | 2 | RM60200-2CR |
| RM60200-3CR | | | | | 3 | RM60200-3CR |
| RM60400-1CR | CVR-RH-60400 | CVRI-RH-60400 | | 400 | 1 | RM60400-1CR |
| RM60400-2CR | | | | | 2 | RM60400-2CR |
| RM60400-3CR | | | | | 3 | RM60400-3CR |
| RM60600-1CR | CVR-RH-60600 | CVRI-RH-60600 | | 600 | 1 | RM60600-1CR |
| RM60600-2CR | | | | | 2 | RM60600-2CR |
| RM60600-3CR | | | | | 3 | RM60600-3CR |

COOPER Bussmann
St. Louis MO 63178

TITLE:
Class R fuse holder-CUST

SCALE: 1:1 SIZE: A3 SHEET: 1 OF 14



PUSH DOWN

LIFT UP, THEN
ROTATE OVER

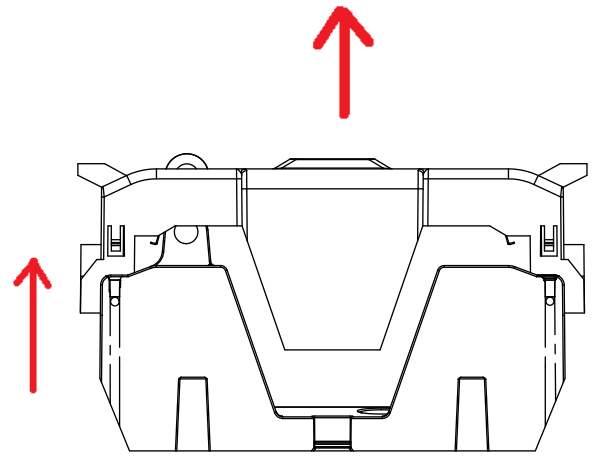
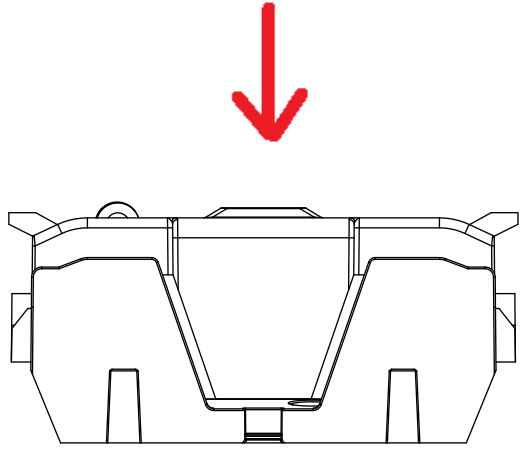
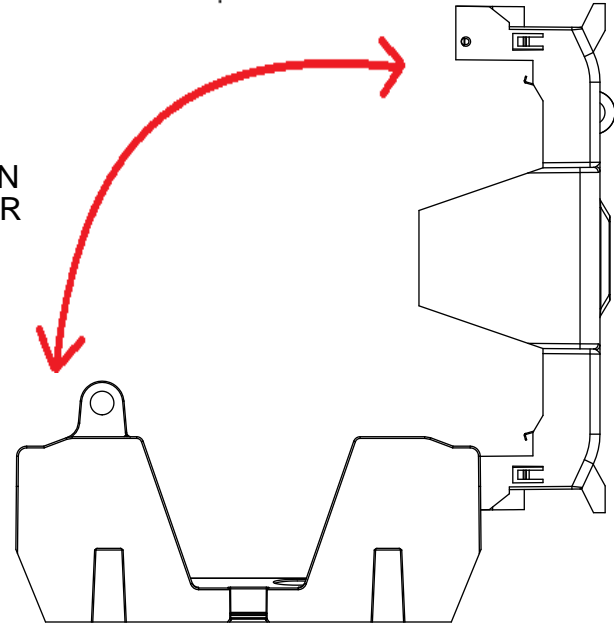

LIFT UP

| | | |
|---|-------------|-------------------|
|  St. Louis MO 63178 | | |
| TITLE: Class R fuse holder-CUST | | |
| SCALE: 1:2 | SIZE: A3 | SHEET: 2 OF 14 |

RM25100-1CR

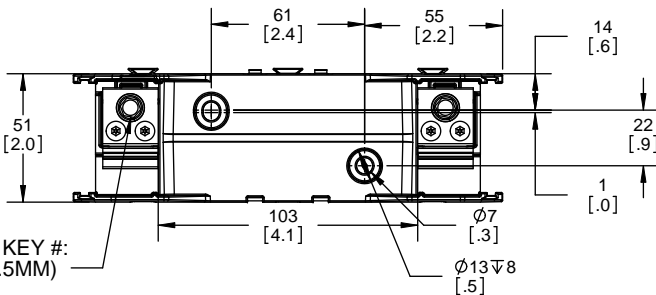

ALLEN KEY #: 3/16" (5.5MM)

RM25100-1CR WITH CVR-RH-25100 INSTALLED

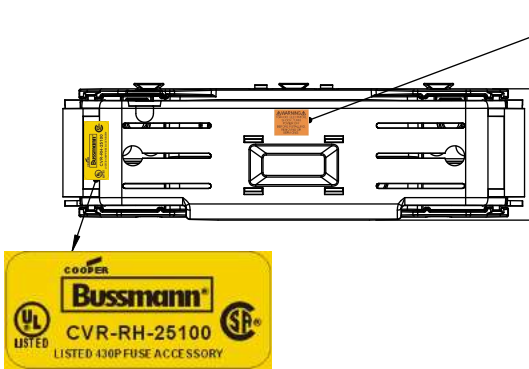

RM25100-1CR WITH CVRI-RH-25100 INSTALLED

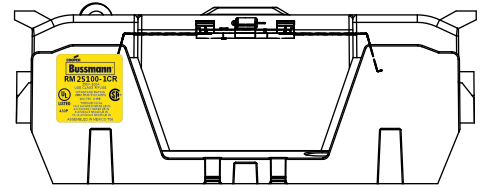
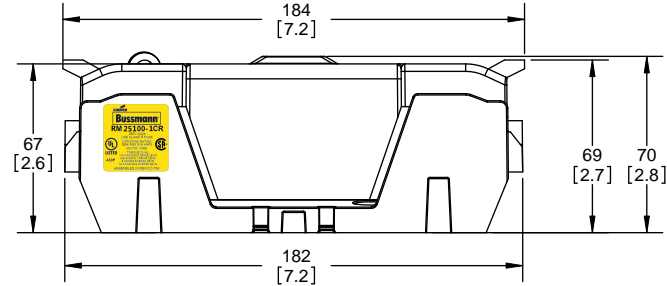
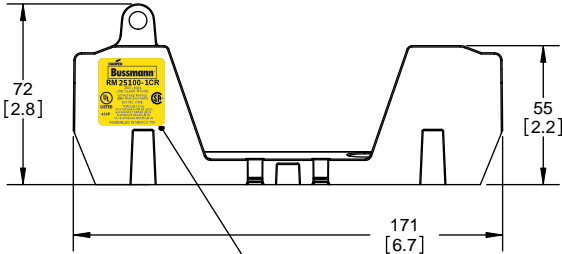
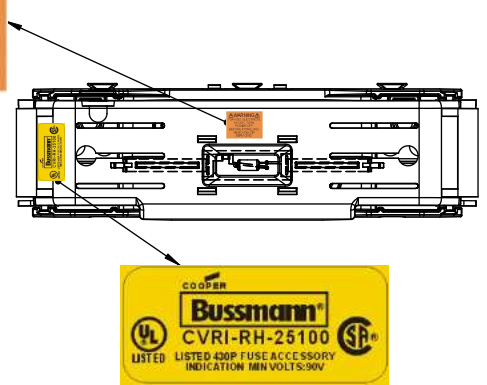

CVR-RH-25100

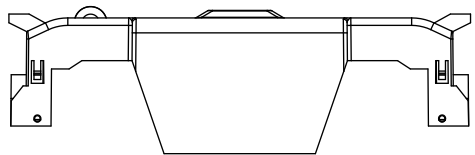

CVRI-RH-25100

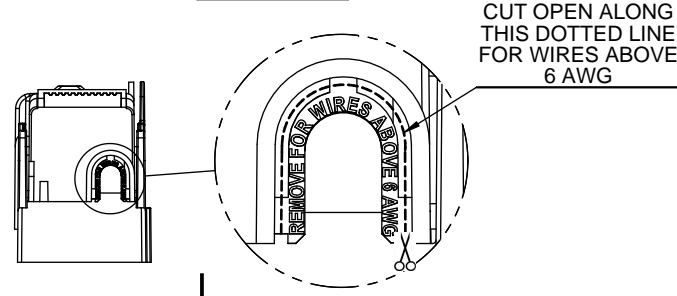
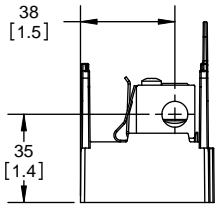
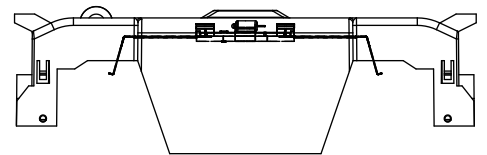

COOPER Bussmann
St. Louis MO 63178

TITLE: **Class R fuse holder-CUST-250V**

SCALE: 1:1 SIZE: A3 SHEET: 3 OF 14

DESIGN UNITS: METRIC (mm)
UNLESS OTHERWISE SPECIFIED
[INCHES]

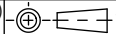

THIRD ANGLE PROJECTION

RM25100-2CR



**RM25100-2CR
WITH CVR-RH-25100 INSTALLED**



**RM25100-2CR
WITH CVRI-RH-25100 INSTALLED**



COOPER Bussmann
St. Louis MO 63178

TITLE:
Class R fuse holder-CUST-250V

SCALE: 1:1 SIZE: A3 SHEET: 4 OF 14

DESIGN UNITS: METRIC (mm)
UNLESS OTHERWISE SPECIFIED
[INCHES]



THIRD ANGLE PROJECTION

RM25100-3CR



**RM25100-3CR
WITH CVR-RH-25100 INSTALLED**



**RM25100-3CR
WITH CVRI-RH-25100 INSTALLED**

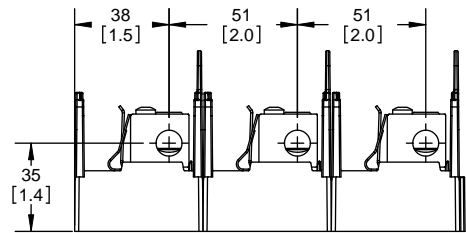
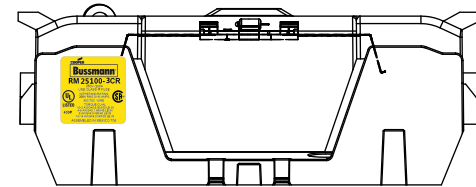
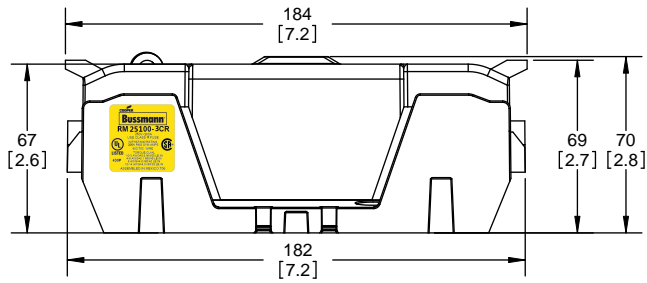
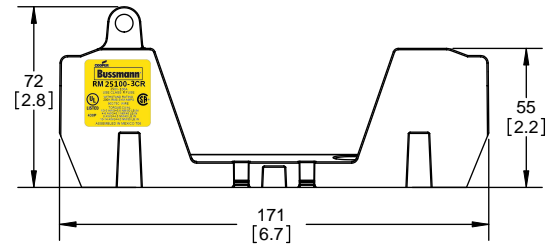
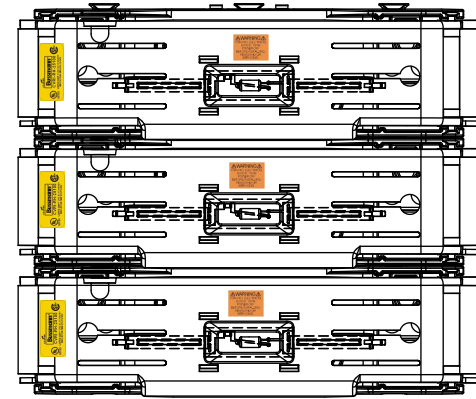

COOPER Bussmann
St. Louis MO 63178

Class R fuse holder-CUST-250V

SCALE: 1:1 SIZE: A3 SHEET: 5 OF 14

DESIGN UNITS: METRIC (mm)
UNLESS OTHERWISE SPECIFIED
[INCHES]



THIRD ANGLE PROJECTION

RM25200-2CR

**RM25200-2CR
WITH CVR-RH-25200 INSTALLED**

**RM25200-2CR
WITH CVRI-RH-25200 INSTALLED**



COOPER Bussmann
St. Louis MO 63178

TITLE:
Class R fuse holder-CUST-250V

SCALE: 1:1 SIZE: A3 SHEET: 7 OF 14

DESIGN UNITS: METRIC (mm)
UNLESS OTHERWISE SPECIFIED [INCHES]



THIRD ANGLE PROJECTION

RM25200-3CR

**RM25200-3CR
WITH CVR-RH-25200 INSTALLED**

**RM25200-3CR
WITH CVRI-RH-25200 INSTALLED**

ALLEN KEY #:
3/8" (10.0MM)



COOPER Bussmann
St. Louis MO 63178

TITLE:
Class R fuse holder-CUST-250V

SCALE: 1:1 SIZE: A3 SHEET: 8 OF 14

DESIGN UNITS: METRIC (mm)
UNLESS OTHERWISE SPECIFIED
[INCHES]

THIRD ANGLE PROJECTION

RM25400-1CR



**RM25400-1CR
WITH CVR-RH-25400 INSTALLED**



**RM25400-1CR
WITH CVRI-RH-25400 INSTALLED**

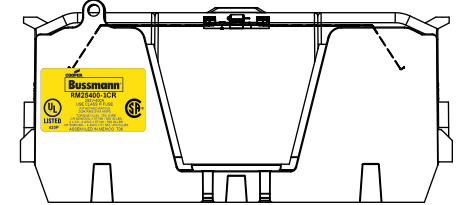
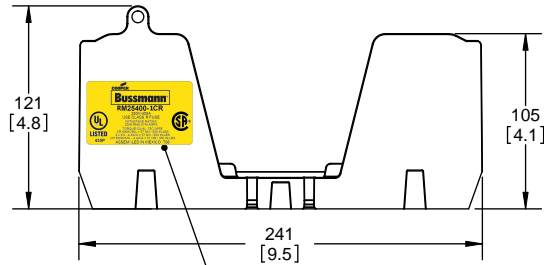
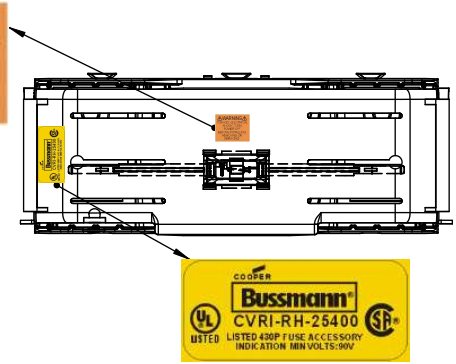

CVR-RH-25400



CVRI-RH-25400

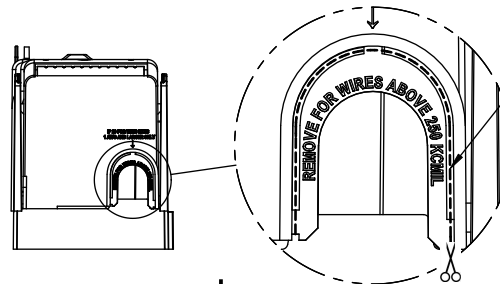
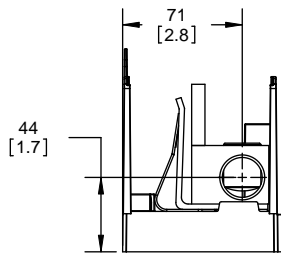
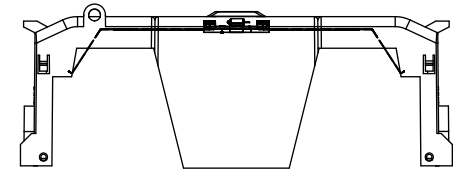

COOPER Bussmann
St. Louis MO 63178

Class R fuse holder-CUST-250V

SCALE: 1:1 SIZE: A3 SHEET: 9 OF 14

DESIGN UNITS: METRIC (mm)
UNLESS OTHERWISE SPECIFIED [INCHES]



THIRD ANGLE PROJECTION

RM25400-2CR



**RM25400-2CR
WITH CVR-RH-25400 INSTALLED**



**RM25400-2CR
WITH CVRI-RH-25400 INSTALLED**



COOPER Bussmann
St. Louis MO 63178

TITLE:
Class R fuse holder-CUST-250V

SCALE: 1:1 SIZE: A3 SHEET: 10 OF 14

DESIGN UNITS: METRIC (mm) UNLESS OTHERWISE SPECIFIED
 THIRD ANGLE PROJECTION

RM25600-1CR



RM25600-1CR WITH CVR-RH-25600 INSTALLED

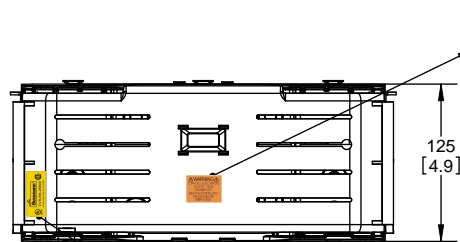

RM25600-1CR WITH CVRI-RH-25600 INSTALLED

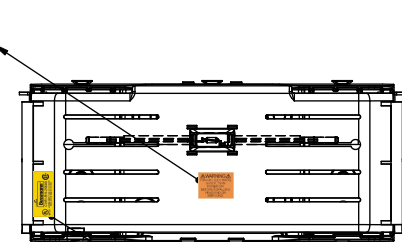

WARNING
 TO AVOID ELECTRICAL SHOCK, TURN POWER OFF BEFORE INSTALLING, REMOVING OR SERVICING.

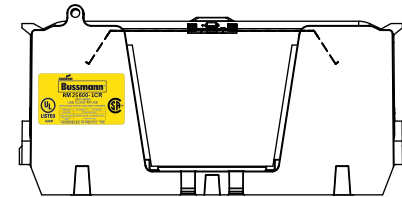
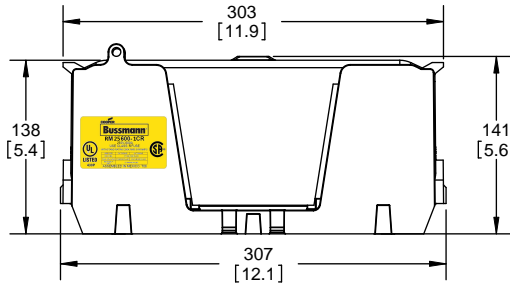
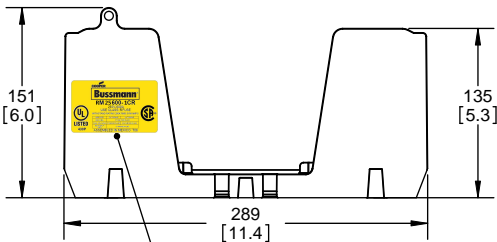
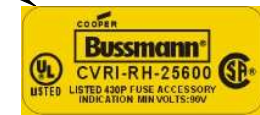

CVR-RH-25600

CVRI-RH-25600

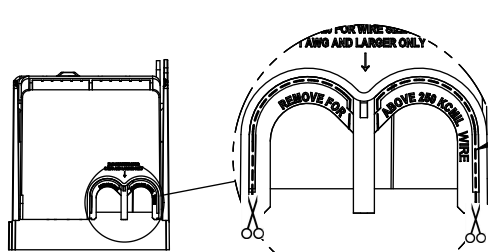
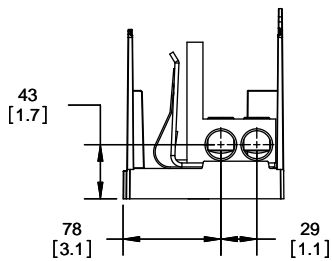
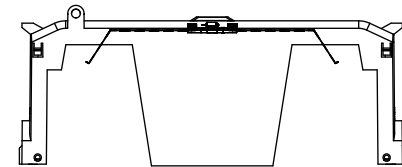
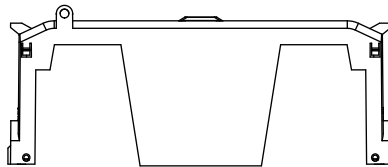

CUT OPEN ALONG THIS DOTTED LINE FOR WIRES ABOVE 250 KCMIL

COOPER Bussmann
 St. Louis MO 63178

Class R fuse holder-CUST-250V

SCALE: 1:1 SIZE: A3 SHEET: 12 OF 14

DESIGN UNITS: METRIC (mm)
UNLESS OTHERWISE SPECIFIED
[INCHES]



THIRD ANGLE PROJECTION

RM25600-2CR

**RM25600-2CR
WITH CVR-RH-25600 INSTALLED**

**RM25600-2CR
WITH CVRI-RH-25600 INSTALLED**

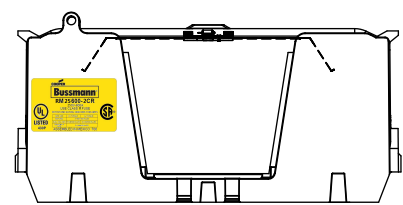
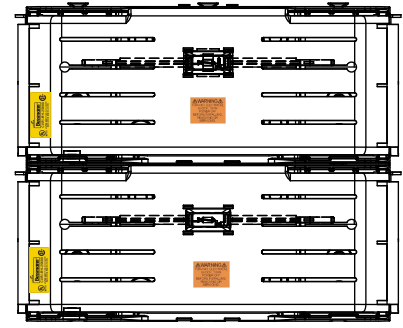

COOPER Bussmann
St. Louis MO 63178

TITLE:
Class R fuse holder-CUST-250V

SCALE: 1:1 SIZE: A3 SHEET: 13 OF 14

DESIGN UNITS: METRIC (mm)
UNLESS OTHERWISE SPECIFIED
[INCHES]



THIRD ANGLE PROJECTION

RM25600-3CR



**RM25600-3CR
WITH CVR-RH-25600 INSTALLED**



**RM25600-3CR
WITH CVRI-RH-25600 INSTALLED**



COOPER Bussmann
St. Louis MO 63178

TITLE: **Class R fuse holder-CUST-250V**

SCALE: 1:1 SIZE: A3 SHEET: 14 OF 14

RM60100-1CR

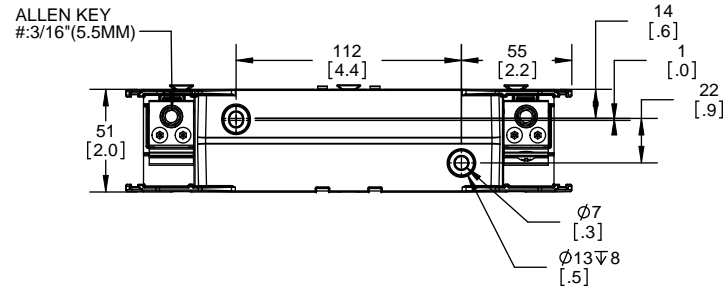

RM60100-1CR WITH CVR-RH-60100 INSTALLED

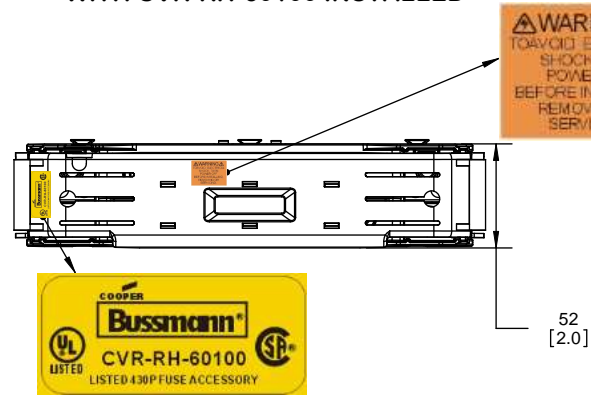

RM60100-1CR WITH CVRI-RH-60100 INSTALLED

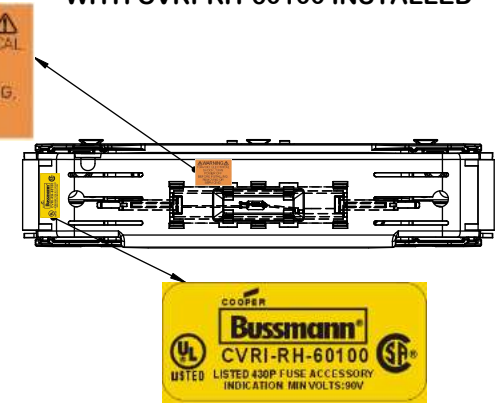

WARNING
 TO AVOID ELECTRICAL SHOCK, TURN POWER OFF BEFORE INSTALLING, REMOVING OR SERVICING.

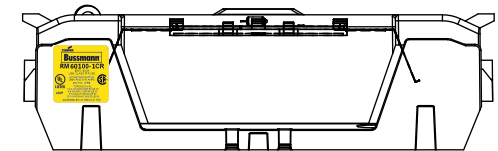
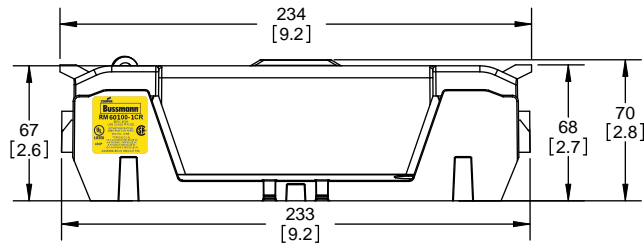
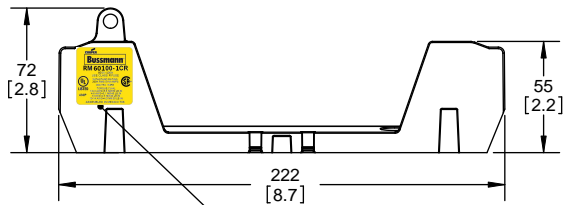

CVR-RH-60100

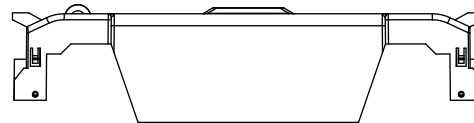

CVRI-RH-60100

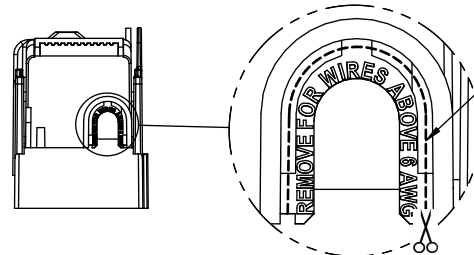
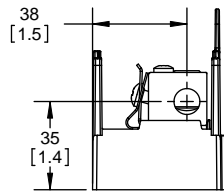
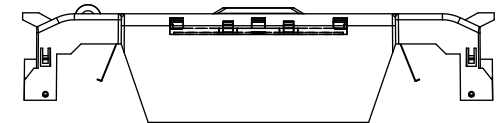

COOPER Bussmann
 St. Louis MO 63178

TITLE:
Class R fuse holder-CUST-600V

SCALE: 1:1 SIZE: A3 SHEET: 1 OF 12

| REVISIONS | | | | | |
|-----------|------|-------------|------|-----|----|
| REV | ZONE | DESCRIPTION | DATE | ECN | BY |
| | | | | | |

RM60100-2CR

**RM60100-2CR
WITH CVR-RH-60100 INSTALLED**

**RM60100-2CR
WITH CVRI-RH-60100 INSTALLED**

ALLEN KEY
#3/16" (5.5MM)

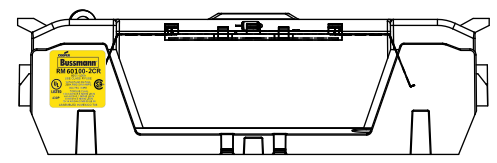

COOPER Bussmann
St. Louis MO 63178

TITLE:
Class R fuse holder-CUST-600V

SCALE: 1:1 SIZE: A3 SHEET: 2 OF 12

RM60100-3CR

RM60100-3CR WITH CVR-RH-60100 INSTALLED

RM60100-3CR WITH CVRI-RH-60100 INSTALLED



COOPER Bussmann
St. Louis MO 63178

TITLE:
Class R fuse holder-CUST-600V

SCALE: 1:1 SIZE: A3 SHEET: 3 OF 12

| REVISIONS | | | DATE | ECN | BY |
|-----------|------|-------------|------|-----|----|
| REV | ZONE | DESCRIPTION | | | |

RM60200-1CR

RM60200-1CR WITH CVR-RH-60200 INSTALLED

RM60200-1CR WITH CVRI-RH-60200 INSTALLED



CVR-RH-60200

CVRI-RH-60200



COOPER Bussmann
St. Louis MO 63178

TITLE: **Class R fuse holder-CUST-600V**

SCALE: 1:1 SIZE: A3 SHEET: 4 OF 12

RM60200-3CR

**RM60200-3CR
WITH CVR-RH-60200 INSTALLED**

**RM60200-3CR
WITH CVRI-RH-60200 INSTALLED**

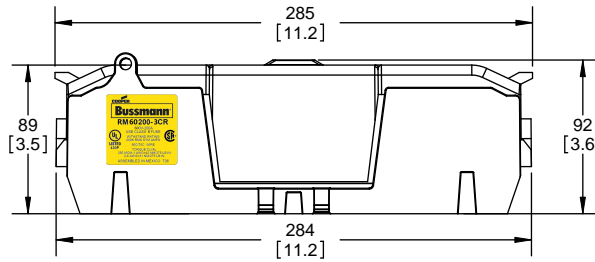

COOPER Bussmann
St. Louis MO 63178

TITLE: **Class R fuse holder-CUST-600V**

SCALE: 1:1 SIZE: A3 SHEET: 6 OF 12

RM60400-1CR



RM60400-1CR WITH CVR-RH-60400 INSTALLED



RM60400-1CR WITH CVRI-RH-60400 INSTALLED



COOPER Bussmann RM60400-1CR
600V-400A
USE CLASS R FUSE
WITHSTAND RATING
200K RMS SYM AMPS
TORQUE CU/AL 75C WIRE
CR 600KCMIL = 57 NM / 500 IN-LBS
2 x 3/0 - 4 AWG = 57 NM / 500 IN-LBS
CR 500KCMIL - 4 AWG = 51 NM / 450 IN-LBS
ASSEMBLED IN MEXICO T06

UL LISTED 430P SA

CVR-RH-60400

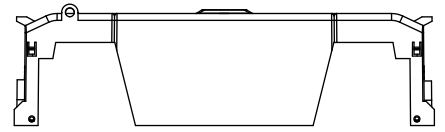

CVRI-RH-60400



CUT OPEN ALONG THIS DOTTED LINE FOR WIRES ABOVE 250 KCMIL

COOPER Bussmann
St. Louis MO 63178

TITLE: **Class R fuse holder-CUST-600V**

SCALE: 1:1 SIZE: A3 SHEET: 7 OF 12

| REVISIONS | | | DATE | ECN | BY |
|-----------|------|-------------|------|-----|----|
| REV | ZONE | DESCRIPTION | | | |

RM60400-2CR



**RM60400-2CR
WITH CVR-RH-60400 INSTALLED**



**RM60400-2CR
WITH CVRI-RH-60400 INSTALLED**



COOPER Bussmann
St. Louis MO 63178

TITLE:
Class R fuse holder-CUST-600V

SCALE: 1:1 SIZE: A3 SHEET: 8 OF 12

DESIGN UNITS: METRIC (mm)
UNLESS OTHERWISE SPECIFIED
[INCHES]



THIRD ANGLE PROJECTION

| REVISIONS | | | DATE | ECN | BY |
|-----------|------|-------------|------|-----|----|
| REV | ZONE | DESCRIPTION | | | |

RM60400-3CR

**RM60400-3CR
WITH CVR-RH-60400 INSTALLED**

**RM60400-3CR
WITH CVRI-RH-60400 INSTALLED**



COOPER Bussmann
St. Louis MO 63178

TITLE:
Class R fuse holder-CUST-600V

SCALE: 1:1 SIZE: A3 SHEET: 9 OF 12

| REVISIONS | | | | DATE | ECN | BY |
|-----------|------|-------------|--|------|-----|----|
| REV | ZONE | DESCRIPTION | | | | |
| | | | | | | |

RM60600-2CR



**RM60600-2CR
WITH CVR-RH-60600 INSTALLED**



**RM60600-2CR
WITH CVRI-RH-60600 INSTALLED**



COOPER Bussmann
St. Louis MO 63178

TITLE:
Class R fuse holder-CUST-600V

SCALE: 1:5 SIZE: A3 SHEET: 11 OF 12

| REVISIONS | | | | DATE | ECN | BY |
|-----------|------|-------------|--|------|-----|----|
| REV | ZONE | DESCRIPTION | | | | |

RM60600-3CR



ALLEN KEY #:
3/8" (10.0MM)

**RM60600-3CR
WITH CVR-RH-60600 INSTALLED**

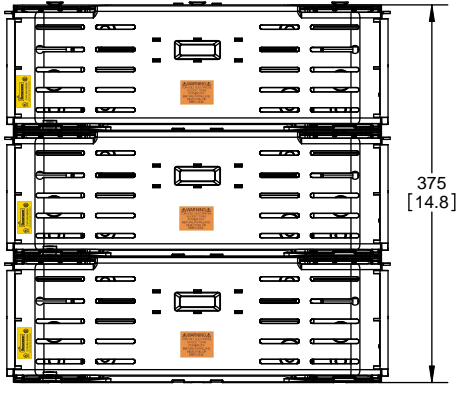

**RM60600-3CR
WITH CVRI-RH-60600 INSTALLED**

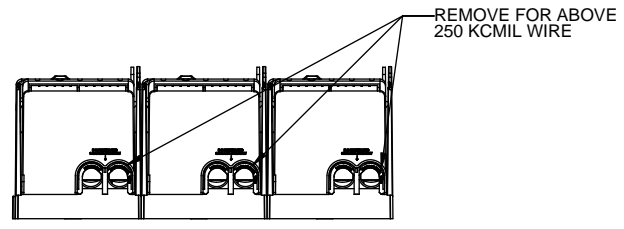
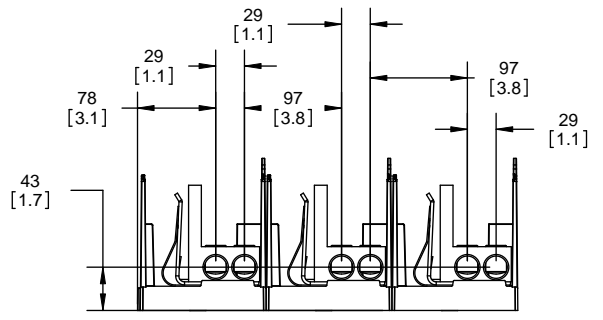
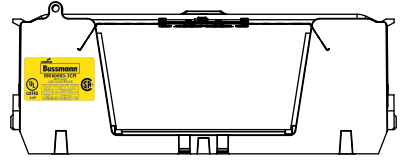
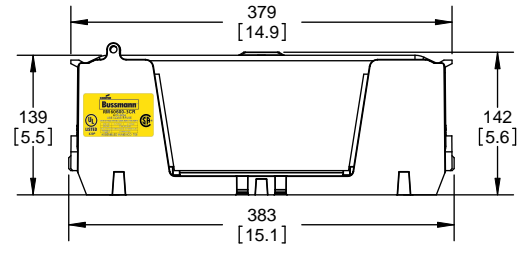
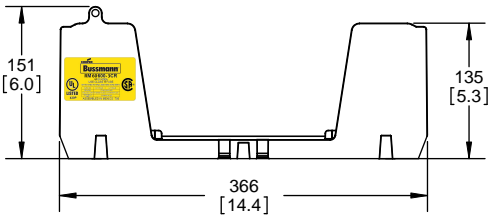
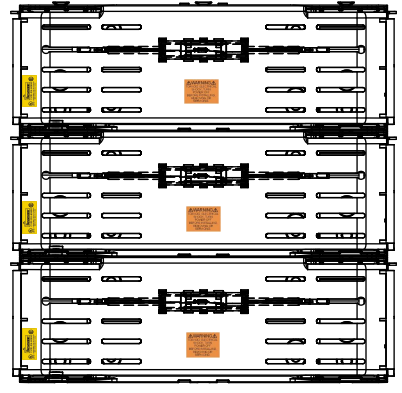

COOPER Bussmann
St. Louis MO 63178

TITLE:
Class R fuse holder-CUST-600V

SCALE: 1:5 SIZE: A3 SHEET: 12 OF 12