

Trench gate field-stop IGBT, HB series 650 V, 60 A high speed

Datasheet - production data

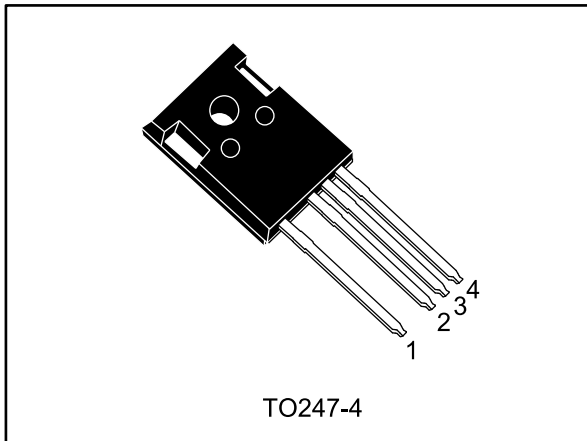
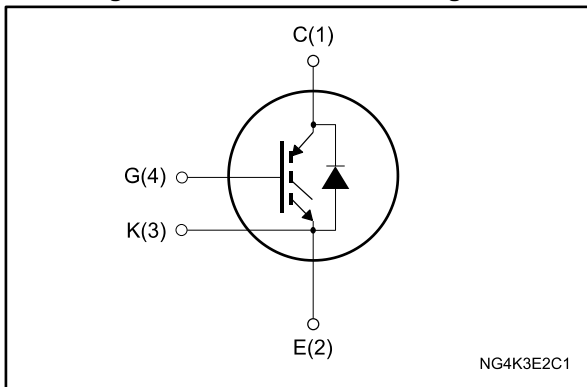

Figure 1: Internal schematic diagram



Features

- Maximum junction temperature: $T_J = 175\text{ }^\circ\text{C}$
- Kelvin pin
- Low $V_{CE(sat)} = 1.6\text{ V (typ.) @ } I_C = 60\text{ A}$
- Minimized tail current
- Tight parameter distribution
- Safe paralleling
- Low thermal resistance
- Very fast soft recovery antiparallel diode

Applications

- Photovoltaic inverter
- High frequency converter

Description

This device is an IGBT developed using an advanced proprietary trench gate field-stop structure. The device is part of the new HB series of IGBTs, which represents an optimum compromise between conduction and switching loss to maximize the efficiency of any frequency converter. A faster switching event can be achieved by the Kelvin pin, which separates power path from driving signal. Furthermore, the slightly positive $V_{CE(sat)}$ temperature coefficient and very tight parameter distribution result in safer paralleling operation.

Table 1: Device summary

Order code	Marking	Package	Packing
STGW60H65DFB-4	G60H65DFB	TO247-4	Tube

Contents

1	Electrical ratings	3
2	Electrical characteristics	4
	2.1 Electrical characteristics (curves).....	6
3	Test circuits	11
4	Package information	12
	4.1 TO247-4 package information.....	12
5	Revision history	14

1 Electrical ratings

Table 2: Absolute maximum ratings

Symbol	Parameter	Value	Unit
V _{CES}	Collector-emitter voltage (V _{GE} = 0 V)	650	V
I _C	Continuous collector current at T _C = 25 °C	80 ⁽¹⁾	A
	Continuous collector current at T _C = 100 °C	60	
I _{CP} ⁽²⁾	Pulsed collector current	240	A
V _{GE}	Gate-emitter voltage	±20	V
I _F	Continuous forward current at T _C = 25 °C	80 ⁽¹⁾	A
	Continuous forward current at T _C = 100 °C	60	
I _{FP} ⁽²⁾	Pulsed forward current	240	A
P _{TOT}	Total dissipation at T _C = 25 °C	375	W
T _{STG}	Storage temperature range	-55 to 150	°C
T _J	Operating junction temperature range	-55 to 175	

Notes:

⁽¹⁾Current level is limited by bond wires.

⁽²⁾Pulse width is limited by maximum junction temperature.

Table 3: Thermal data

Symbol	Parameter	Value	Unit
R _{thJC}	Thermal resistance junction-case IGBT	0.4	°C/W
R _{thJC}	Thermal resistance junction-case diode	1.14	
R _{thJA}	Thermal resistance junction-ambient	50	

2 Electrical characteristics

$T_C = 25\text{ °C}$ unless otherwise specified

Table 4: Static characteristics

Symbol	Parameter	Test conditions	Min.	Typ.	Max.	Unit
$V_{(BR)CES}$	Collector-emitter breakdown voltage	$V_{GE} = 0\text{ V}$, $I_C = 2\text{ mA}$	650			V
$V_{CE(sat)}$	Collector-emitter saturation voltage	$V_{GE} = 15\text{ V}$, $I_C = 60\text{ A}$		1.6	2.0	V
		$V_{GE} = 15\text{ V}$, $I_C = 60\text{ A}$, $T_J = 125\text{ °C}$		1.75		
		$V_{GE} = 15\text{ V}$, $I_C = 60\text{ A}$, $T_J = 175\text{ °C}$		1.85		
V_F	Forward on-voltage	$I_F = 60\text{ A}$		2	2.6	V
		$I_F = 60\text{ A}$, $T_J = 125\text{ °C}$		1.7		
		$I_F = 60\text{ A}$, $T_J = 175\text{ °C}$		1.6		
$V_{GE(th)}$	Gate threshold voltage	$V_{CE} = V_{GE}$, $I_C = 1\text{ mA}$	5	6	7	V
I_{CES}	Collector cut-off current	$V_{GE} = 0\text{ V}$, $V_{CE} = 650\text{ V}$			25	μA
I_{GES}	Gate-emitter leakage current	$V_{CE} = 0\text{ V}$, $V_{GE} = \pm 20\text{ V}$			± 250	nA

Table 5: Dynamic characteristics

Symbol	Parameter	Test conditions	Min.	Typ.	Max.	Unit
C_{ies}	Input capacitance	$V_{CE} = 25\text{ V}$, $f = 1\text{ MHz}$, $V_{GE} = 0\text{ V}$	-	7792	-	nF
C_{oes}	Output capacitance		-	262	-	
C_{res}	Reverse transfer capacitance		-	158	-	
Q_g	Total gate charge	$V_{CC} = 520\text{ V}$, $I_C = 60\text{ A}$, $V_{GE} = 0\text{ to }15\text{ V}$ (see Figure 29: "Gate charge test circuit")	-	306	-	nC
Q_{ge}	Gate-emitter charge		-	126	-	
Q_{gc}	Gate-collector charge		-	58	-	

Table 6: IGBT switching characteristics (inductive load)

Symbol	Parameter	Test conditions	Min.	Typ.	Max.	Unit
$t_{d(on)}$	Turn-on delay time	$V_{CE} = 400\text{ V}$, $I_C = 60\text{ A}$, $V_{GE} = 15\text{ V}$, $R_G = 10\ \Omega$ (see Figure 28: "Test circuit for inductive load switching")	-	65	-	ns
t_r	Current rise time		-	26	-	ns
$(di/dt)_{on}$	Turn-on current slope		-	1846	-	A/ μ s
$t_{d(off)}$	Turn-off-delay time		-	261	-	ns
t_f	Current fall time		-	21	-	ns
$E_{on}^{(1)}$	Turn-on switching energy		-	346	-	μ J
$E_{off}^{(2)}$	Turn-off switching energy		-	1161	-	μ J
E_{ts}	Total switching energy	-	1507	-	μ J	
$t_{d(on)}$	Turn-on delay time	$V_{CE} = 400\text{ V}$, $I_C = 60\text{ A}$, $V_{GE} = 15\text{ V}$, $R_G = 10\ \Omega$ $T_J = 175\text{ }^\circ\text{C}$ (see Figure 28: "Test circuit for inductive load switching")	-	61	-	ns
t_r	Current rise time		-	30	-	ns
$(di/dt)_{on}$	Turn-on current slope		-	1640	-	A/ μ s
$t_{d(off)}$	Turn-off-delay time		-	284	-	ns
t_f	Current fall time		-	45	-	ns
$E_{on}^{(1)}$	Turn-on switching energy		-	644	-	μ J
$E_{off}^{(2)}$	Turn-off switching energy		-	1633	-	μ J
E_{ts}	Total switching energy	-	2277	-	μ J	

Notes:

(1)Including the reverse recovery of the diode.

(2)Including the tail of the collector current.

Table 7: Diode switching characteristics (inductive load)

Symbol	Parameter	Test conditions	Min.	Typ.	Max.	Unit
t_{rr}	Reverse recovery time	$I_F = 60\text{ A}$, $V_R = 400\text{ V}$, $V_{GE} = 15\text{ V}$, $di/dt = 1000\text{ A}/\mu\text{s}$ (see Figure 28: "Test circuit for inductive load switching")	-	60	-	ns
Q_{rr}	Reverse recovery charge		-	99	-	nC
I_{rrm}	Reverse recovery current		-	3.3	-	A
dl_{rr}/dt	Peak rate of fall of reverse recovery current during t_b		-	187	-	A/ μ s
E_{rr}	Reverse recovery energy		-	68	-	μ J
t_{rr}	Reverse recovery time	$I_F = 60\text{ A}$, $V_R = 400\text{ V}$, $V_{GE} = 15\text{ V}$, $di/dt = 1000\text{ A}/\mu\text{s}$, $T_J = 175\text{ }^\circ\text{C}$ (see Figure 28: "Test circuit for inductive load switching")	-	310	-	ns
Q_{rr}	Reverse recovery charge		-	1550	-	nC
I_{rrm}	Reverse recovery current		-	10	-	A
dl_{rr}/dt	Peak rate of fall of reverse recovery current during t_b		-	59	-	A/ μ s
E_{rr}	Reverse recovery energy		-	674	-	μ J

2.1 Electrical characteristics (curves)

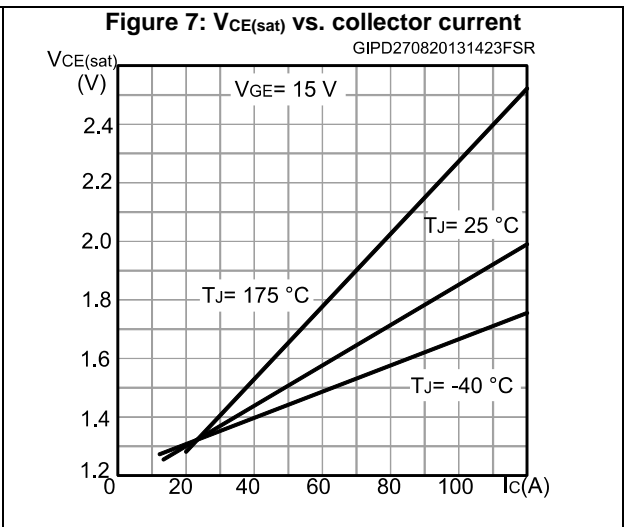
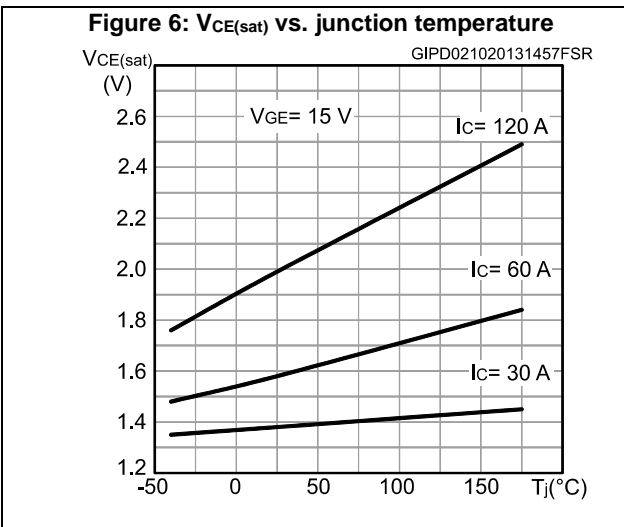
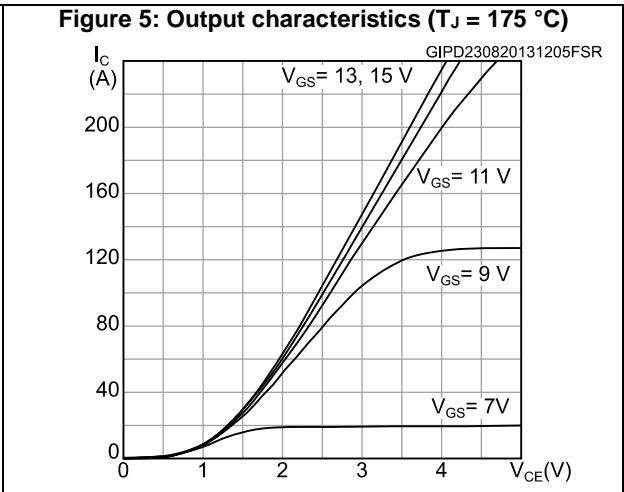
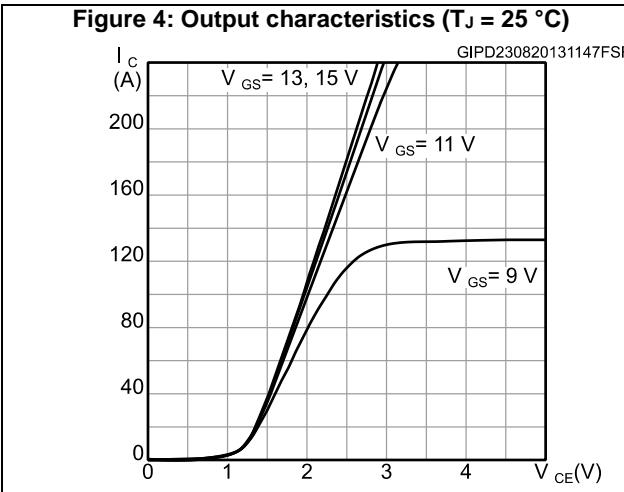
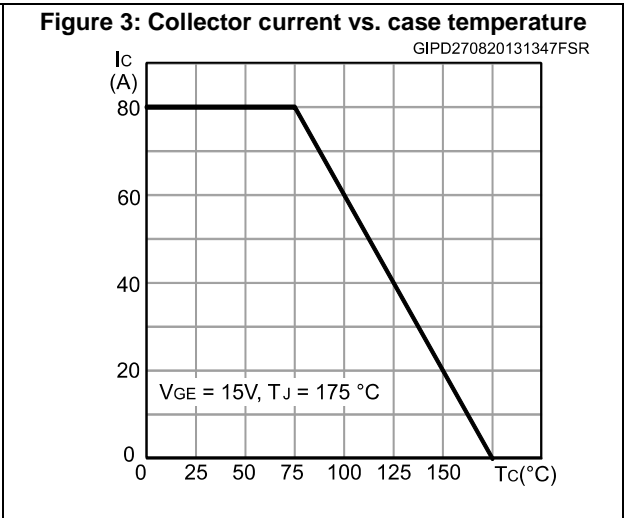
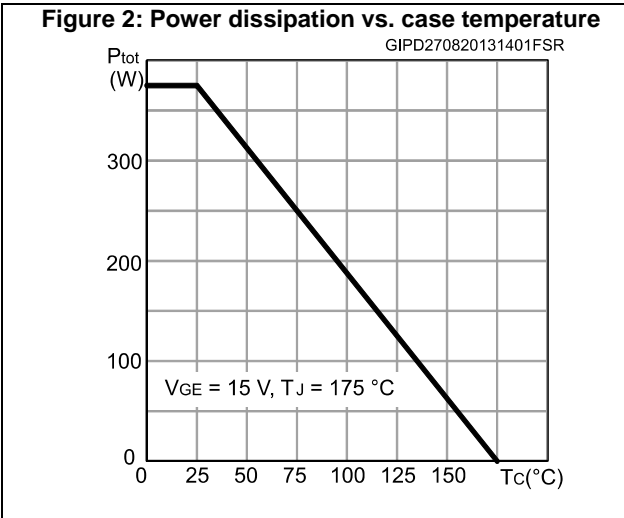

Figure 8: Collector current vs. switching frequency

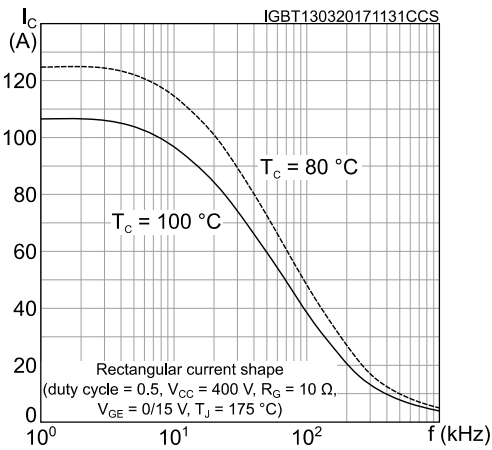

Figure 9: Forward bias safe operating area

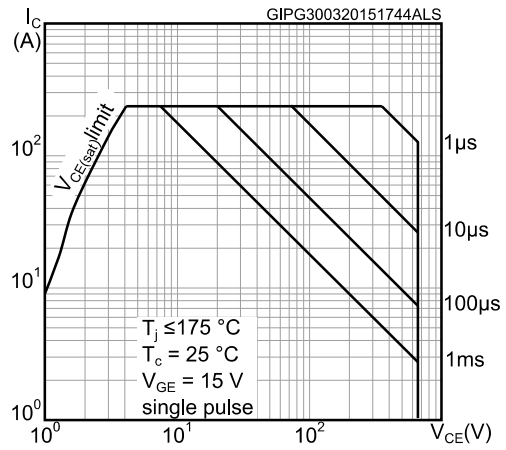

Figure 10: Transfer characteristics

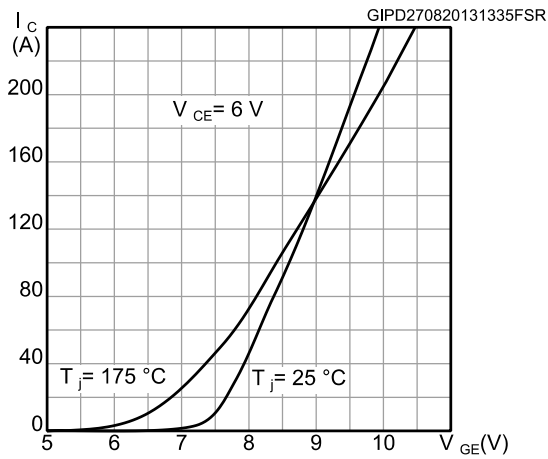

Figure 11: Diode V_F vs. forward current

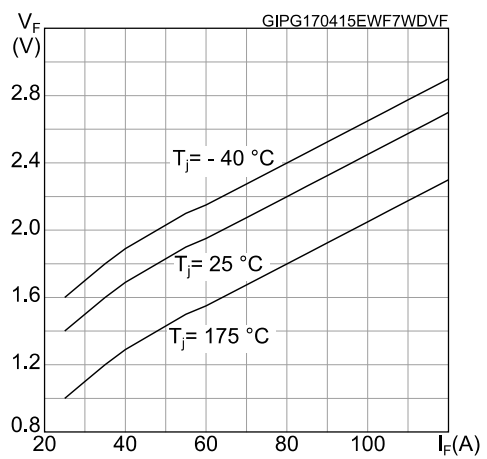

Figure 12: Normalized V_GE(th) vs. junction temperature

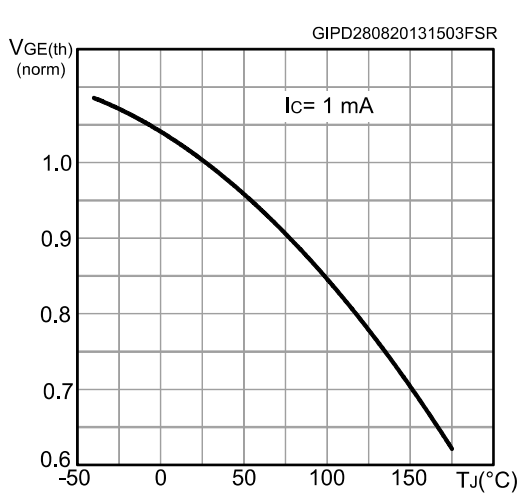
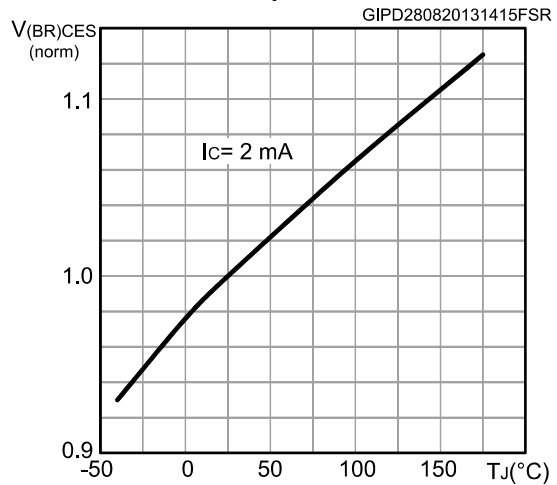

Figure 13: Normalized V_(BR)CES vs. junction temperature



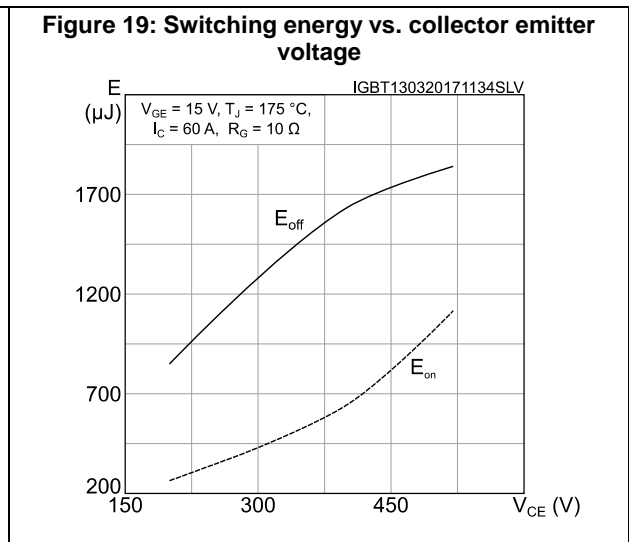
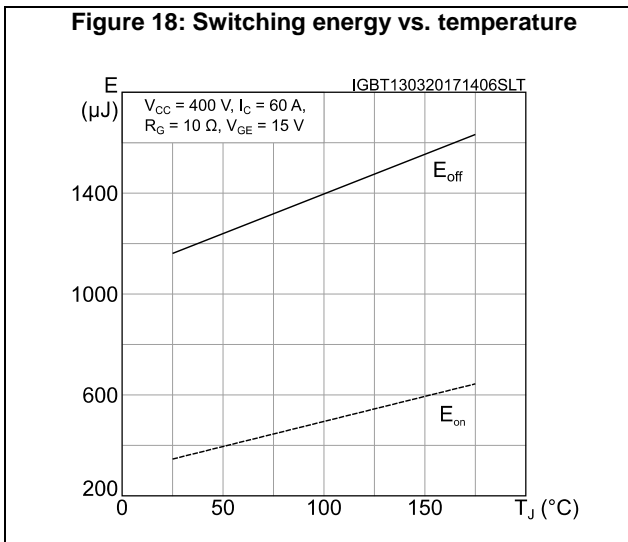
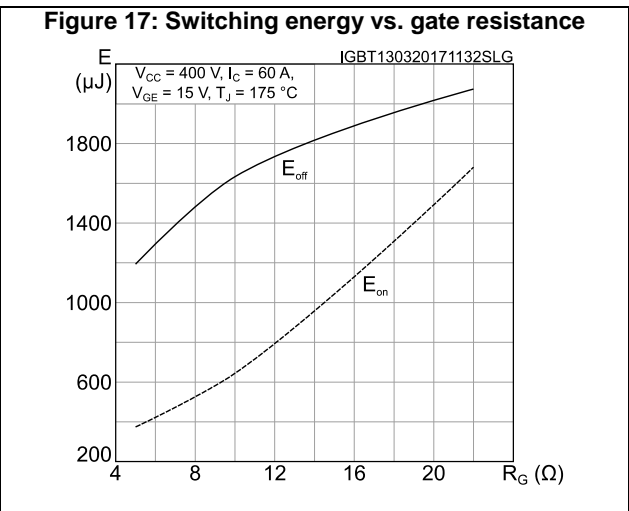
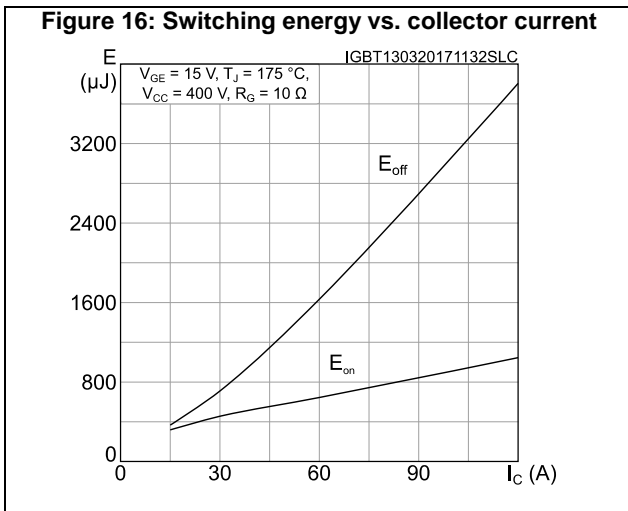
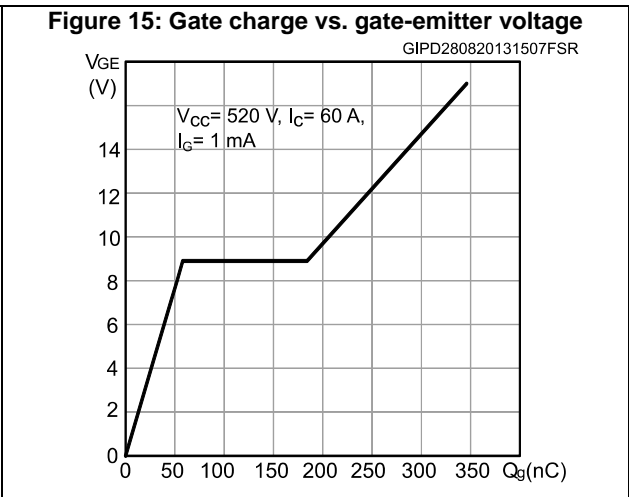
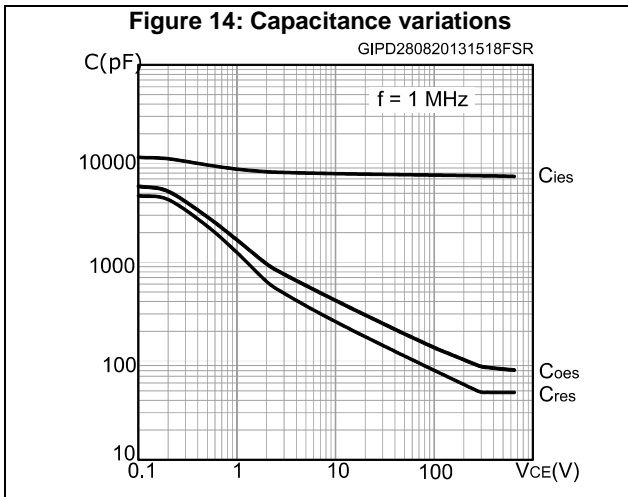

Figure 20: Switching times vs. collector current

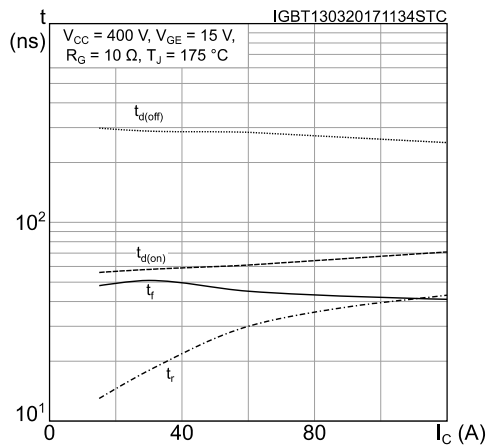

Figure 21: Switching times vs. gate resistance

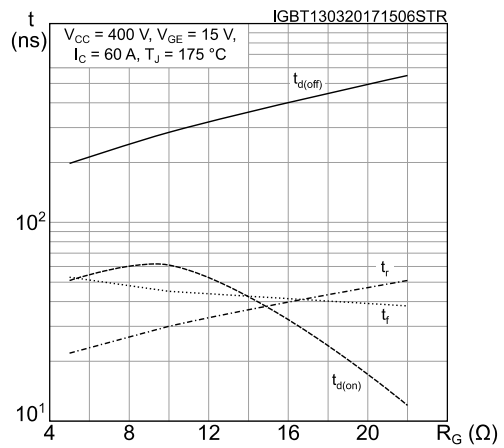

Figure 22: Reverse recovery current vs. diode current slope

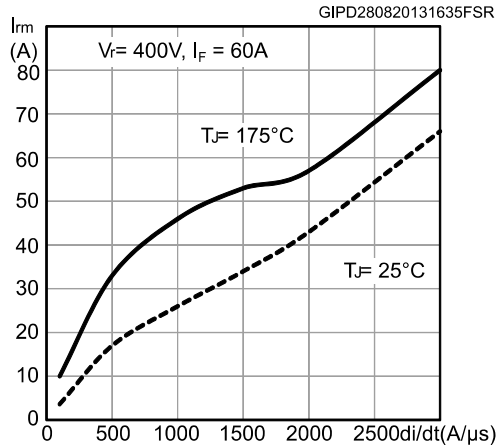

Figure 23: Reverse recovery time vs. diode current slope

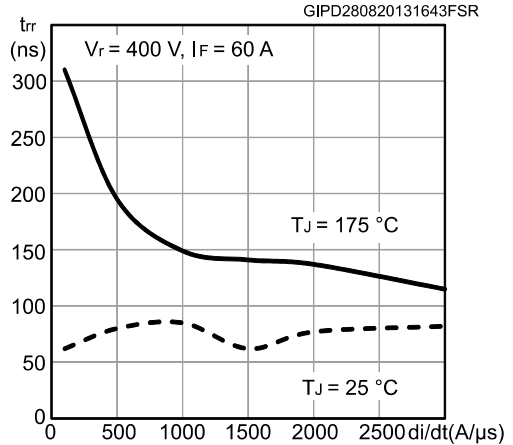

Figure 24: Reverse recovery charge vs. diode current slope

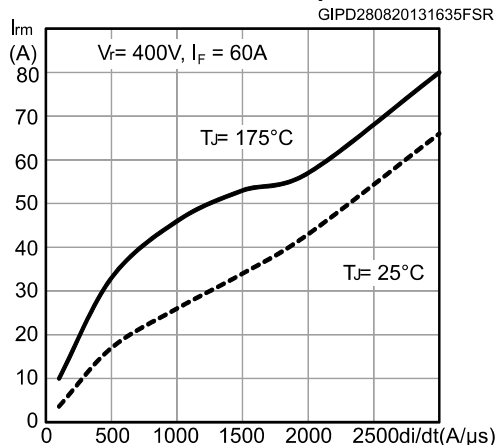

Figure 25: Reverse recovery energy vs. diode current slope

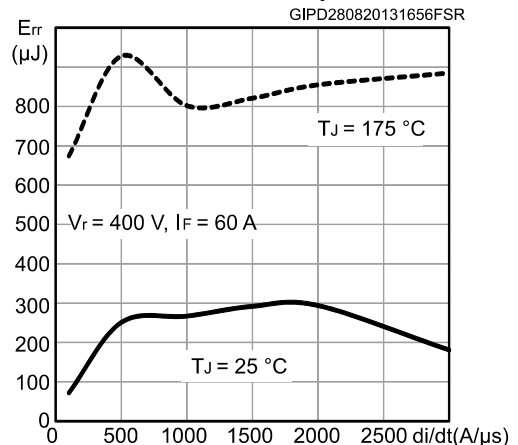

Figure 26: Thermal impedance for IGBT

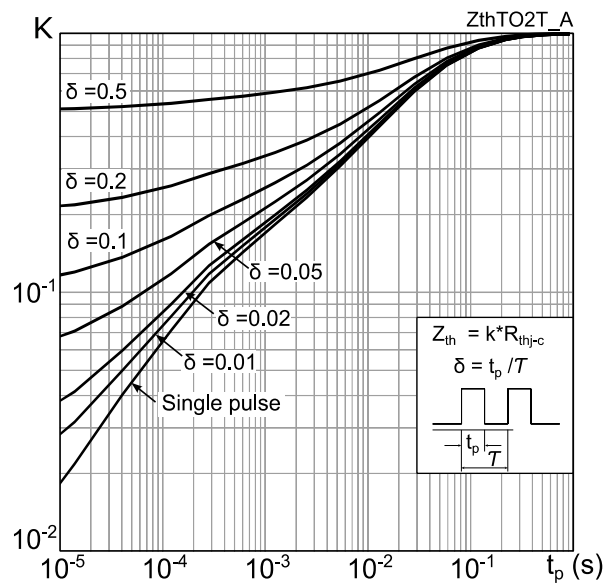
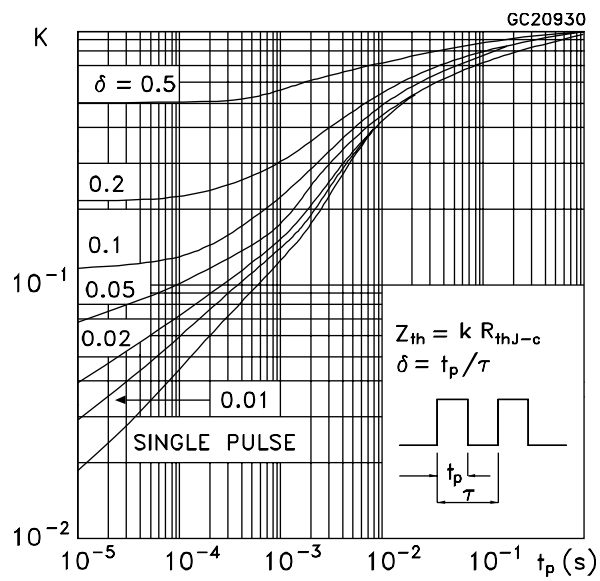

Figure 27: Thermal impedance for diode



3 Test circuits

Figure 28: Test circuit for inductive load switching

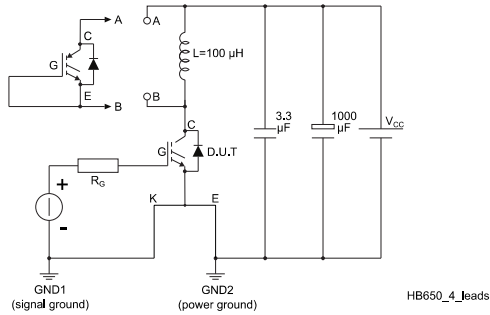

Figure 29: Gate charge test circuit

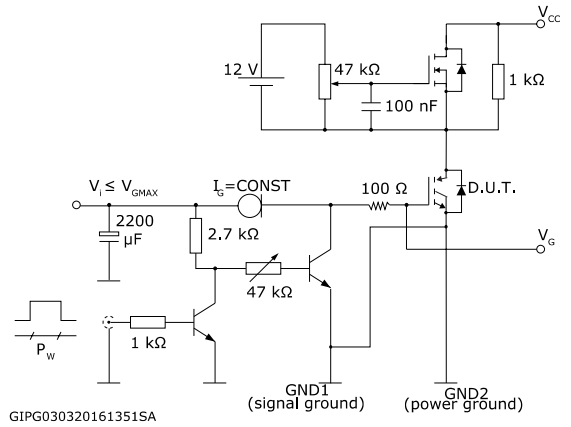
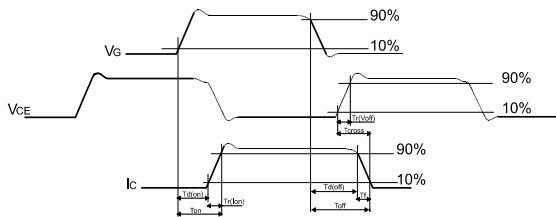
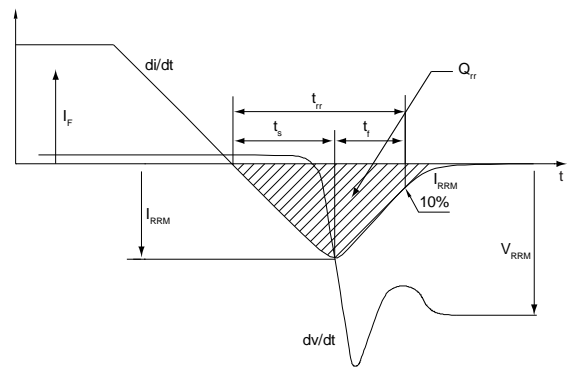

Figure 30: Switching waveform



AM01506v1

Figure 31: Diode reverse recovery waveform



AM01507v1

4 Package information

In order to meet environmental requirements, ST offers these devices in different grades of ECOPACK® packages, depending on their level of environmental compliance. ECOPACK® specifications, grade definitions and product status are available at: www.st.com. ECOPACK® is an ST trademark.

4.1 TO247-4 package information

Figure 32: TO247-4 package outline

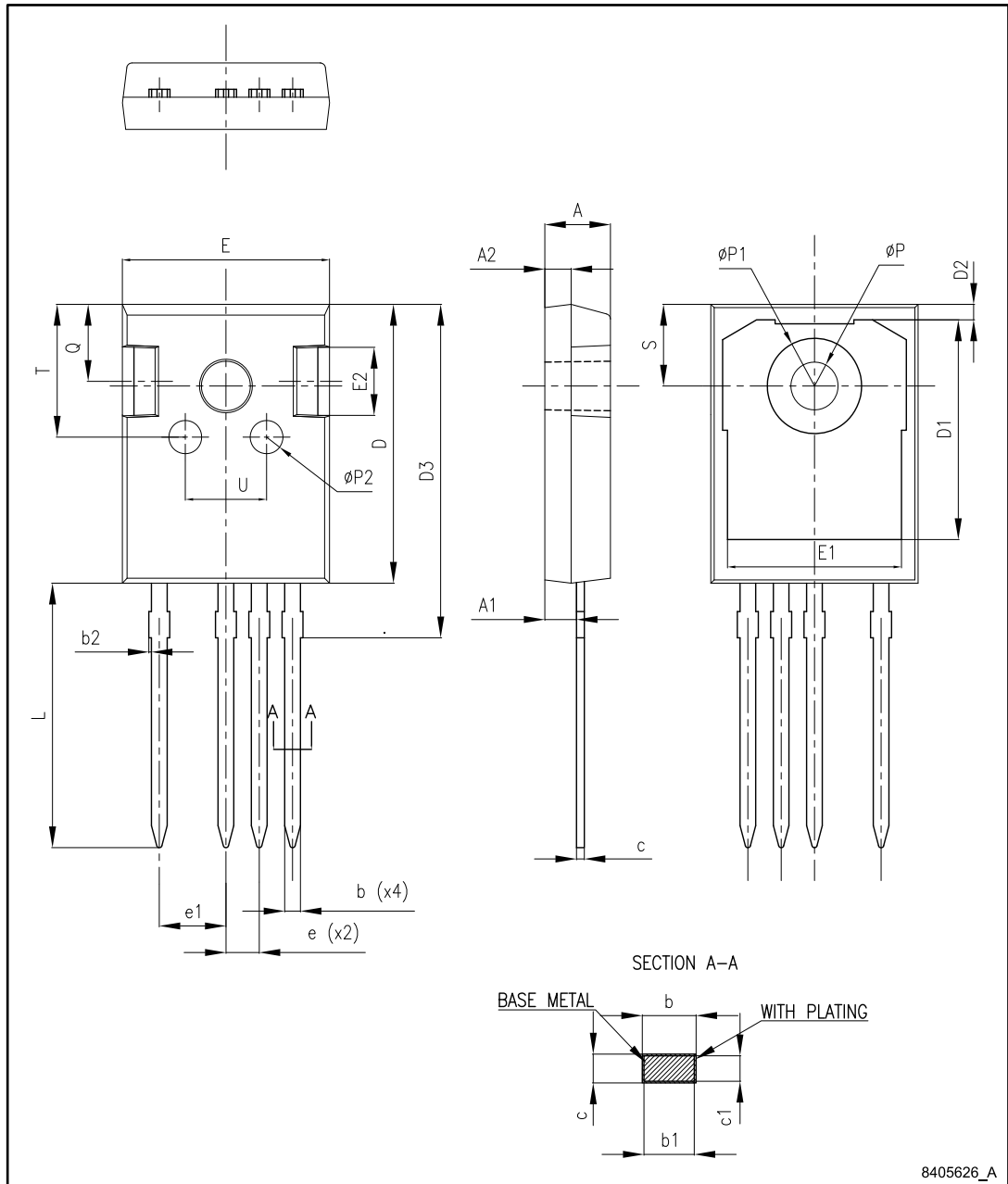

Table 8: TO247-4 mechanical data

Dim.	mm		
	Min.	Typ.	Max.
A	4.90	5.00	5.10
A1	2.31	2.41	2.51
A2	1.90	2.00	2.10
b	1.16		1.29
b1	1.15	1.20	1.25
b2	0		0.20
c	0.59		0.66
c1	0.58	0.60	0.62
D	20.90	21.00	21.10
D1	16.25	16.55	16.85
D2	1.05	1.20	1.35
D3	24.97	25.12	25.27
E	15.70	15.80	15.90
E1	13.10	13.30	13.50
E2	4.90	5.00	5.10
E3	2.40	2.50	2.60
e	2.44	2.54	2.64
e1	4.98	5.08	5.18
L	19.80	19.92	20.10
P	3.50	3.60	3.70
P1			7.40
P2	2.40	2.50	2.60
Q	5.60		6.00
S		6.15	
T	9.80		10.20
U	6.00		6.40

5 Revision history

Table 9: Document revision history

Date	Revision	Changes
30-May-2016	1	First release
21-Mar-2017	2	Updated Table 2: "Absolute maximum ratings" and Table 6: "IGBT switching characteristics (inductive load)" . Updated Section 2.1: "Electrical characteristics (curves)" . Minor text changes

IMPORTANT NOTICE – PLEASE READ CAREFULLY

STMicroelectronics NV and its subsidiaries ("ST") reserve the right to make changes, corrections, enhancements, modifications, and improvements to ST products and/or to this document at any time without notice. Purchasers should obtain the latest relevant information on ST products before placing orders. ST products are sold pursuant to ST's terms and conditions of sale in place at the time of order acknowledgement.

Purchasers are solely responsible for the choice, selection, and use of ST products and ST assumes no liability for application assistance or the design of Purchasers' products.

No license, express or implied, to any intellectual property right is granted by ST herein.

Resale of ST products with provisions different from the information set forth herein shall void any warranty granted by ST for such product.

ST and the ST logo are trademarks of ST. All other product or service names are the property of their respective owners.

Information in this document supersedes and replaces information previously supplied in any prior versions of this document.

© 2017 STMicroelectronics – All rights reserved