

**32 Pole  
With Ground**  
PROTECTION  
**IP65**  
RATING



**Component  
Parts**

**Pre-Assembled Units**

**Covers**

**FEMALE**

29022  
(1-16)

**Insert**

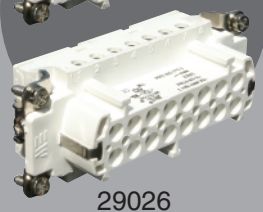

29026  
(17-32)

**Bulkhead Housing**



29046



403050

**Hood**



29660

Standard Part Numbers are  
NPT threads.  
Part numbers with an "M"  
are metric thread.

**Top Entry**  
29062  
29062M

**Side Entry**  
29063  
29063M

**Top Entry**  
403056  
403056M

**Side Entry**  
403057  
403057M

**MALE**

29023  
(1-16)

**Insert**

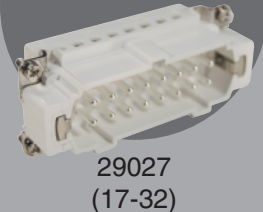
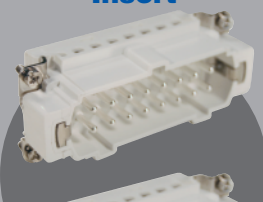

29027  
(17-32)

**Hood**

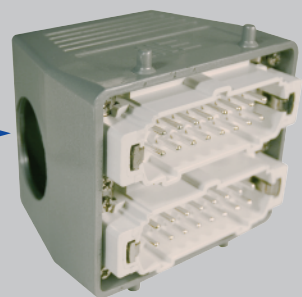
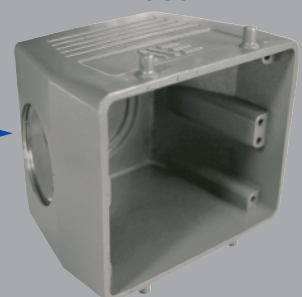

29662

**Top Entry**  
29060  
29060M

**Side Entry**  
29061  
29061M

**Top Entry**  
403054  
403054M

**Side Entry**  
403055  
403055M



Connectors should not be coupled  
and decoupled under electrical load.

**Inserts**

Number of contacts	32 Pole w/ ground
Electrical data to DIN EN61 984	16A 400V 6KV 3
Current	16A
Voltage	400V
Rated Impulse Voltage	6KV
Insulation Resistance	≥10 <sup>10</sup> Ω
Temperature Range	-40 to 125°C
Flammability	UL94-V0

**Contacts**

Screw terminal	
Material	Copper alloy
Surface plated	hard-silver
Contact resistance	≤ 1m Ω
Wire size	2.5mm <sup>2</sup> / 14 AWG
Torque	0.5Nm
Stripping Length	7.5mm

**Metal Hoods & Housings**

Material	Aluminum
Surface	Powder coated
Seals	NBR
Degree of Protection Acc To	
DIN EN60529 for coupled connectors	IP65
Thread Size	NPT 3/4" or M40

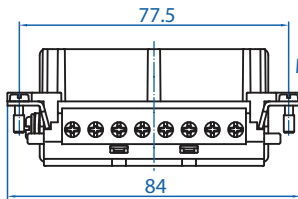
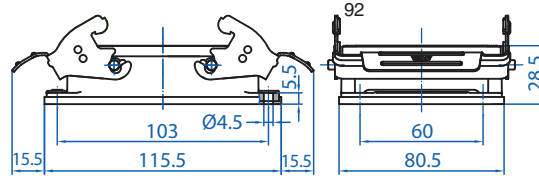

29022  
29026

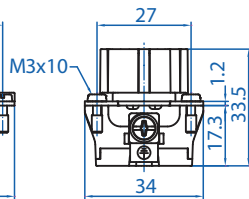

29046

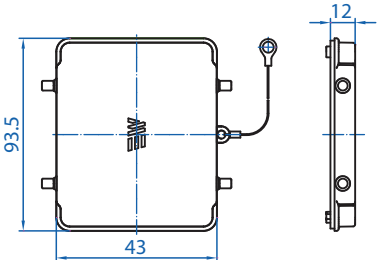

29660

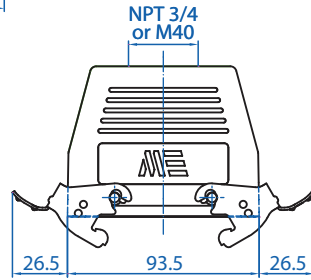

29062

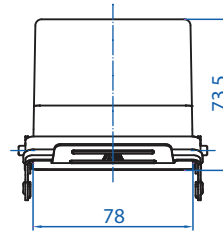

29061

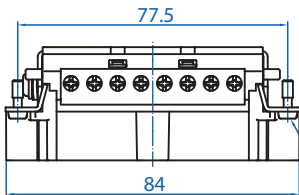

29023  
29027

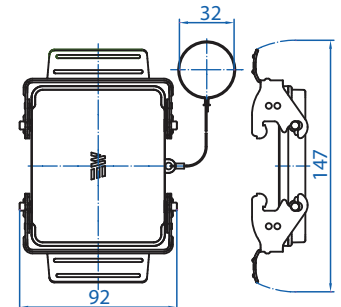
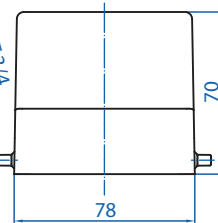
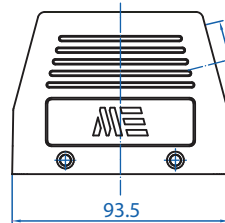
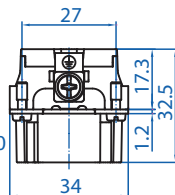

29662



Connectors should not be coupled and decoupled under electrical load.

All dimensions are shown in millimeters. To convert to inches divide by 25.4.