

BROOKE-G2-S

~20° spot beam compatible with LEDiL HEKLA.

TECHNICAL SPECIFICATIONS:

Dimensions	Ø 45.0 mm
Height	18.9 mm
Fastening	socket
ROHS compliant	yes ⓘ

MATERIAL SPECIFICATIONS:

Component	Type	Material	Colour	Finish	Coating
BROOKE-G2-S	Reflector	PC	metal		HMDS





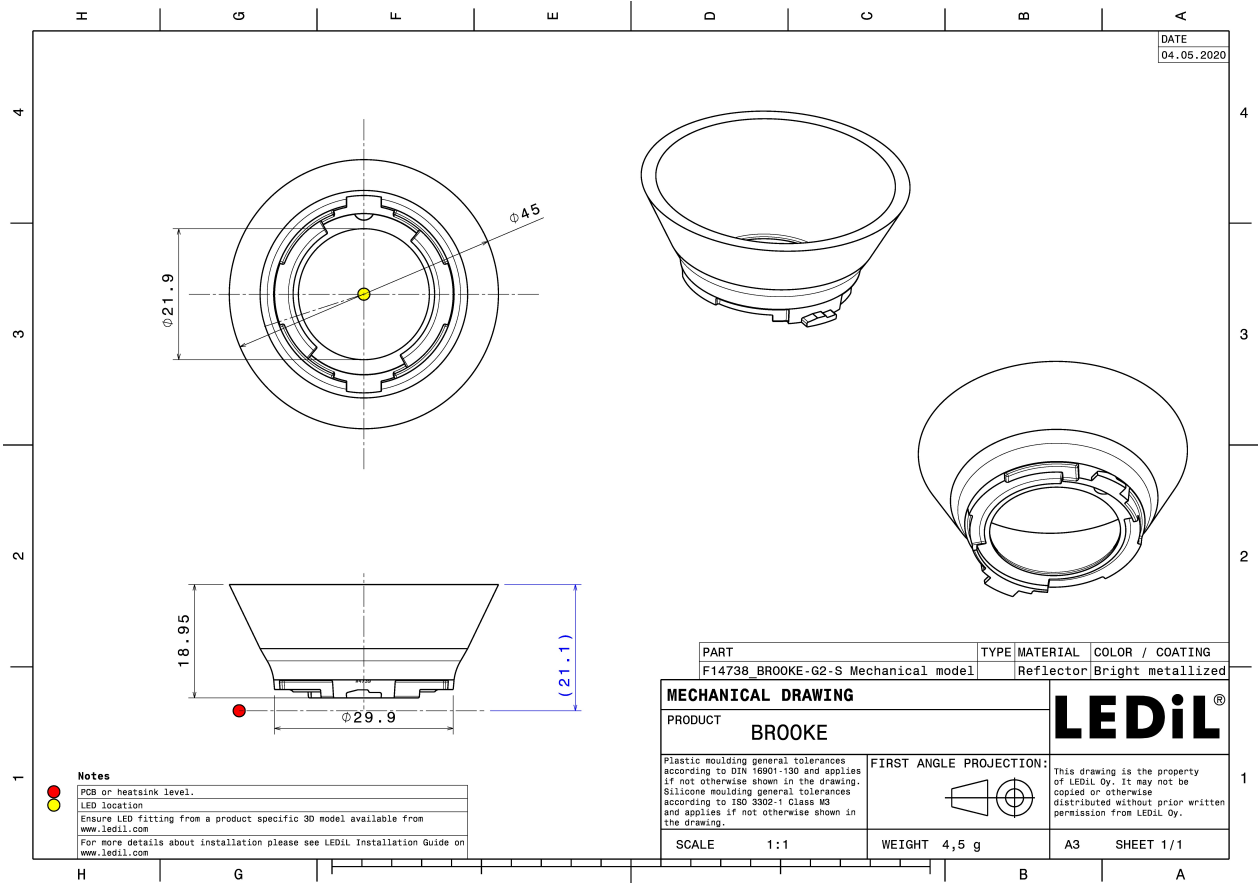

ORDERING INFORMATION:

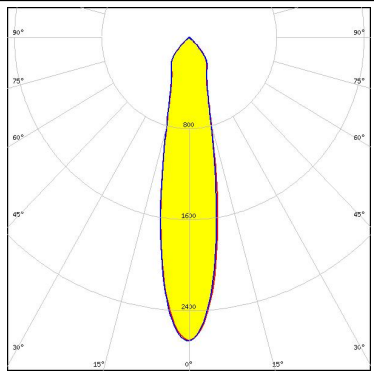

Component	Qty in box	MOQ	MPQ	Box weight (kg)
F14738_BROOKE-G2-S » Box size: 480 x 280 x 300 mm	720	45	45	4.8

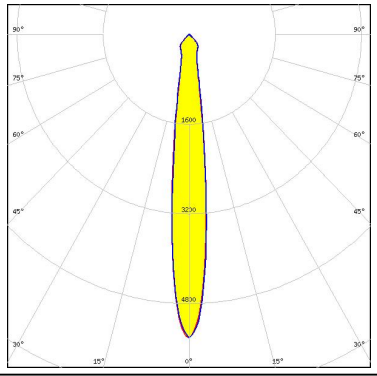

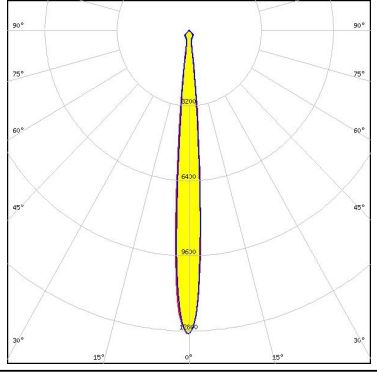
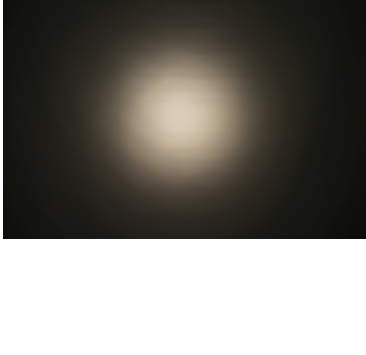
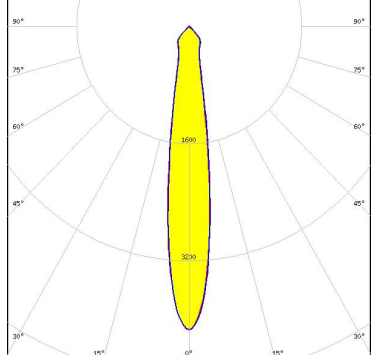

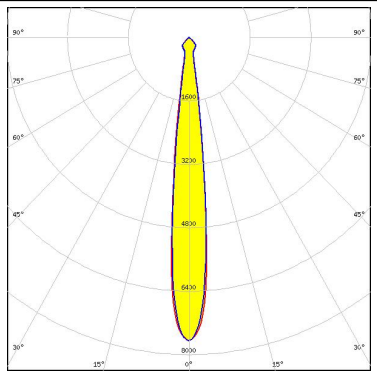
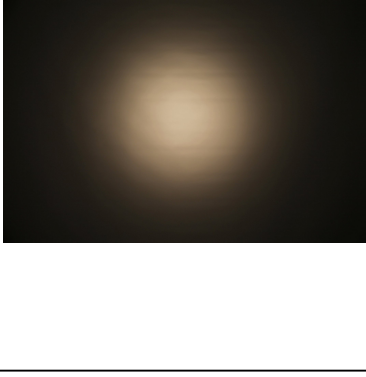
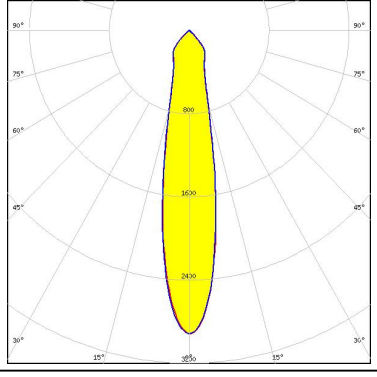
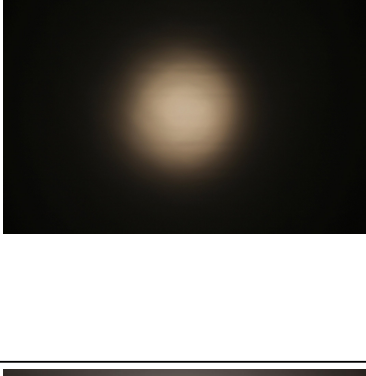
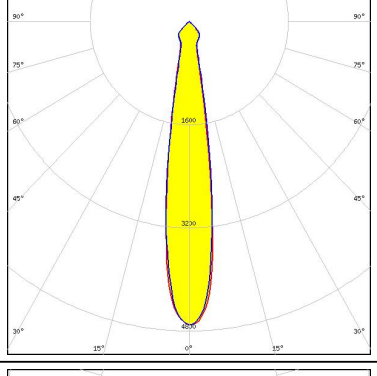

PHOTOMETRIC DATA (MEASURED):

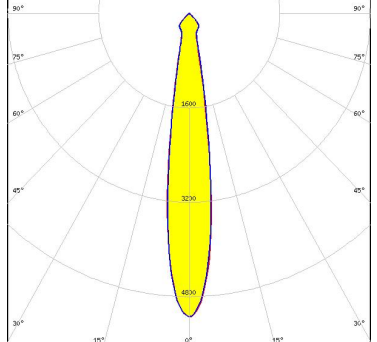
<p>bridgelux.</p> <p>LED V10 Gen7</p> <p>FWHM 22.0°</p> <p>Efficiency 88 %</p> <p>Peak intensity 2.7 cd/lm</p> <p>LEDs/each optic 1</p> <p>Light colour White</p> <p>Required components: F15255_HEKLA-SOCKET-C C14658_BARBARA-RZ-LENS</p>		
<p>bridgelux.</p> <p>LED V4 HD</p> <p>FWHM 13.0°</p> <p>Efficiency 90 %</p> <p>Peak intensity 5.4 cd/lm</p> <p>LEDs/each optic 1</p> <p>Light colour White</p> <p>Required components: F15253_HEKLA-SOCKET-A C14658_BARBARA-RZ-LENS</p>		
<p>bridgelux.</p> <p>LED V4 HD</p> <p>FWHM 8.8°</p> <p>Efficiency 94 %</p> <p>Peak intensity 12.9 cd/lm</p> <p>LEDs/each optic 1</p> <p>Light colour White</p> <p>Required components: F15253_HEKLA-SOCKET-A</p>		
<p>bridgelux.</p> <p>LED V6 HD</p> <p>FWHM 16.0°</p> <p>Efficiency 89 %</p> <p>Peak intensity 4.1 cd/lm</p> <p>LEDs/each optic 1</p> <p>Light colour White</p> <p>Required components: F15255_HEKLA-SOCKET-C C14658_BARBARA-RZ-LENS</p>		



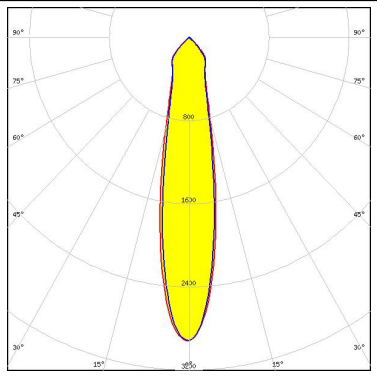

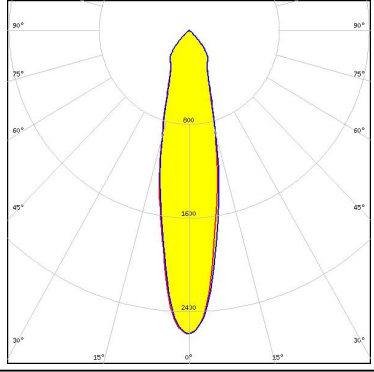
PHOTOMETRIC DATA (MEASURED):

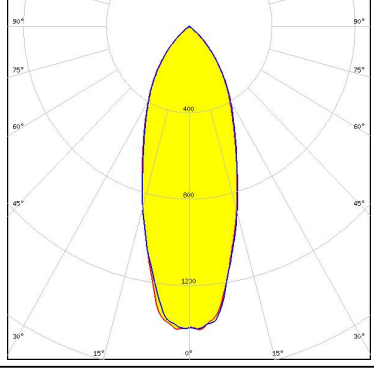
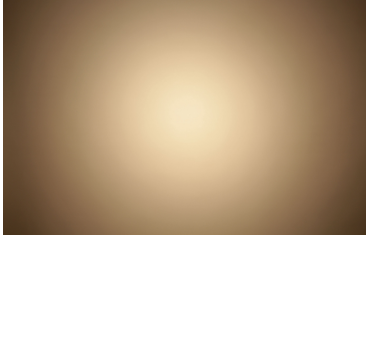
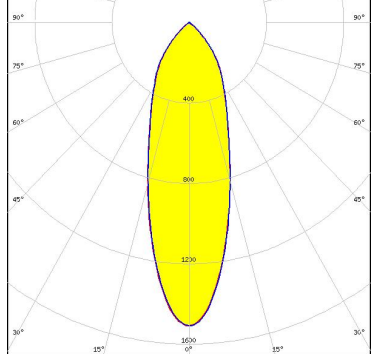
<p>bridgelux.</p> <p>LED V6 HD FWHM 12.0° Efficiency 94 % Peak intensity 7.7 cd/lm LEDs/each optic 1 Light colour White Required components: F15255_HEKLA-SOCKET-C</p>		
<p>bridgelux.</p> <p>LED V9 HD FWHM 21.0° Efficiency 87 % Peak intensity 2.9 cd/lm LEDs/each optic 1 Light colour White Required components: F15859_HEKLA-SOCKET-I C14658_BARBARA-RZ-LENS</p>		
<p>bridgelux.</p> <p>LED V9 HD FWHM 17.0° Efficiency 94 % Peak intensity 4.7 cd/lm LEDs/each optic 1 Light colour White Required components: F15859_HEKLA-SOCKET-I</p>		
<p>bridgelux.</p> <p>LED VERO10 FWHM 16.0° Efficiency 94 % Peak intensity 5.1 cd/lm LEDs/each optic 1 Light colour White Required components: F15616_HEKLA-SOCKET-F</p>		

PHOTOMETRIC DATA (MEASURED):

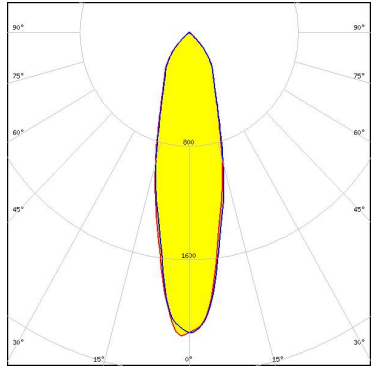
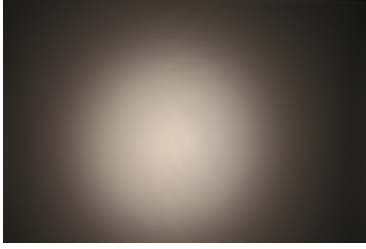
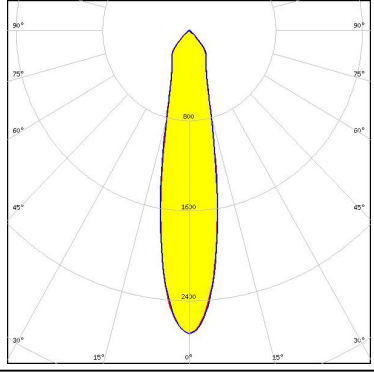
<p>bridgelux.</p> <p>LED VERO10 FWHM 21.0° Efficiency 92 % Peak intensity 2.9 cd/lm LEDs/each optic 1 Light colour White</p> <p>Required components: F15616_HEKLA-SOCKET-F C14658_BARBARA-RZ-LENS</p>		
<p>bridgelux.</p> <p>LED VERO13 FWHM 23.0° Efficiency 90 % Peak intensity 2.6 cd/lm LEDs/each optic 1 Light colour White</p> <p>Required components: C16142_HEKLA-SOCKET-K</p>		
<p>bridgelux.</p> <p>LED VERO18 FWHM 38.0° Efficiency 89 % Peak intensity 1.4 cd/lm LEDs/each optic 1 Light colour White</p> <p>Required components: C16142_HEKLA-SOCKET-K</p>		
<p>bridgelux.</p> <p>LED Vesta DTW 15mm (33W) FWHM 33.0° Efficiency 84 % Peak intensity 1.5 cd/lm LEDs/each optic 1 Light colour White</p> <p>Required components: C16142_HEKLA-SOCKET-K C14658_BARBARA-RZ-LENS Bender Wirth: 491 Typ L8</p>		

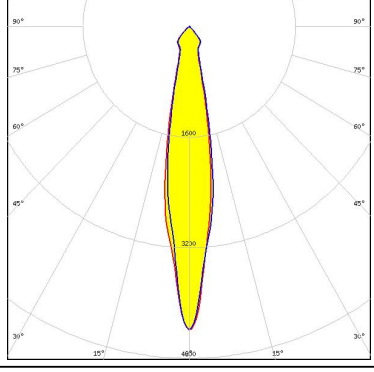
PHOTOMETRIC DATA (MEASURED):

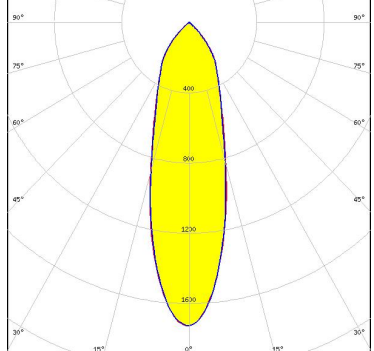
<p>bridgelux.</p> <p>LED Vesta DTW 15mm (33W) FWHM 27.0° Efficiency 91 % Peak intensity 2.1 cd/lm LEDs/each optic 1 Light colour White</p> <p>Required components: C16142_HEKLA-SOCKET-K Bender Wirth: 491 Typ L8</p>		
<p>bridgelux.</p> <p>LED Vesta DTW 9mm (4W/6W/12W) FWHM 22.0° Efficiency 87 % Peak intensity 2.7 cd/lm LEDs/each optic 1 Light colour White</p> <p>Required components: C16142_HEKLA-SOCKET-K C14658_BARBARA-RZ-LENS Bender Wirth: 490 Typ L8</p>		
<p>bridgelux.</p> <p>LED Vesta DTW 9mm (4W/6W/12W) FWHM 18.0° Efficiency 92 % Peak intensity 4.4 cd/lm LEDs/each optic 1 Light colour White</p> <p>Required components: C16142_HEKLA-SOCKET-K Bender Wirth: 490 Typ L8</p>		
<p>bridgelux.</p> <p>LED Vesta TW 13mm (25W) CSP FWHM 30.0° Efficiency 85 % Peak intensity 1.7 cd/lm LEDs/each optic 1 Light colour White</p> <p>Required components: C16142_HEKLA-SOCKET-K C14658_BARBARA-RZ-LENS Bender Wirth: 492 Typ L8</p>		

PHOTOMETRIC DATA (MEASURED):

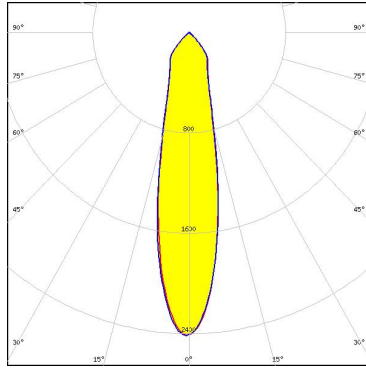
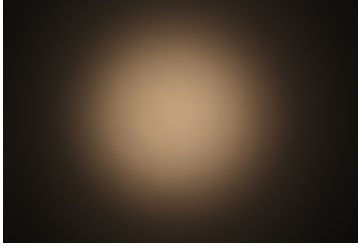
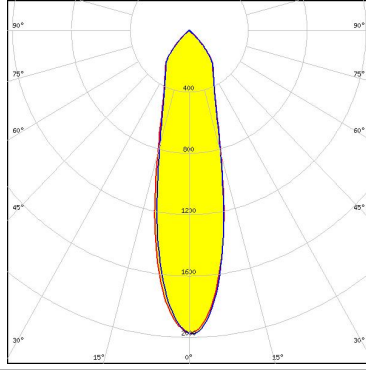
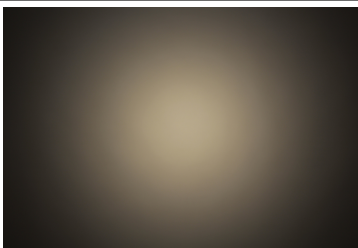
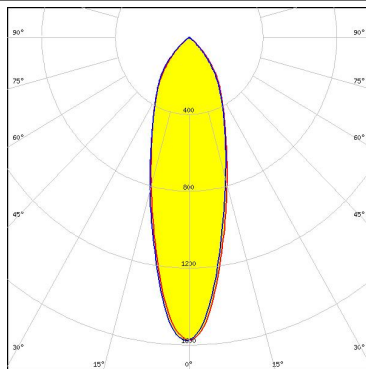
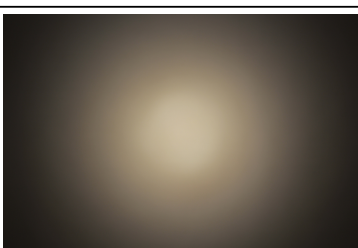
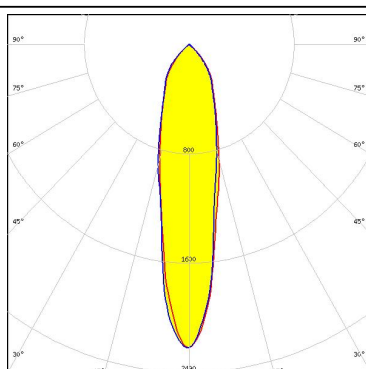
<p>bridgelux.</p> <p>LED Vesta TW 9mm (12W) CSP</p> <p>FWHM 23.0°</p> <p>Efficiency 85 %</p> <p>Peak intensity 2.4 cd/lm</p> <p>LEDs/each optic 1</p> <p>Light colour White</p> <p>Required components: C16142_HEKLA-SOCKET-K C14658_BARBARA-RZ-LENS Bender Wirth: 489 Typ L8</p>		
<p>CITIZEN</p> <p>LED CLC020 Series (Dim-To-Warm)</p> <p>FWHM 26.0°</p> <p>Efficiency 84 %</p> <p>Peak intensity 2 cd/lm</p> <p>LEDs/each optic 1</p> <p>Light colour White</p> <p>Required components: C16142_HEKLA-SOCKET-K C14658_BARBARA-RZ-LENS Bender Wirth: 487 Typ L8</p>		
<p>CITIZEN</p> <p>LED CLC030 Series (Dim-To-Warm)</p> <p>FWHM 30.0°</p> <p>Efficiency %</p> <p>Peak intensity 1.6 cd/lm</p> <p>LEDs/each optic 1</p> <p>Light colour White</p> <p>Required components: C16142_HEKLA-SOCKET-K C14658_BARBARA-RZ-LENS Bender Wirth: 436 Typ L8</p>		
<p>CITIZEN</p> <p>LED CLC030 Series (Dim-To-Warm)</p> <p>FWHM 23.0°</p> <p>Efficiency 89 %</p> <p>Peak intensity 2.2 cd/lm</p> <p>LEDs/each optic 1</p> <p>Light colour White</p> <p>Required components: C16142_HEKLA-SOCKET-K</p>		

PHOTOMETRIC DATA (MEASURED):

CITIZEN

LED CLL02x/CLU02x (LES10)
 FWHM 16.0°
 Efficiency 94 %
 Peak intensity 4.8 cd/lm
 LEDs/each optic 1
 Light colour White
 Required components:
 F15255_HEKLA-SOCKET-C

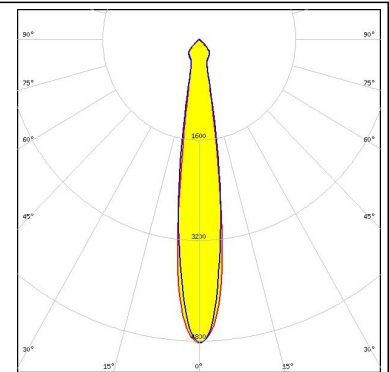

CITIZEN

LED CLL02x/CLU02x (LES10)
 FWHM 16.0°
 Efficiency 94 %
 Peak intensity 4.8 cd/lm
 LEDs/each optic 1
 Light colour White
 Required components:
 F15255_HEKLA-SOCKET-C

CITIZEN

LED CLU700/701/702
 FWHM 12.0°
 Efficiency 94 %
 Peak intensity 7.8 cd/lm
 LEDs/each optic 1
 Light colour White
 Required components:
 F15255_HEKLA-SOCKET-C

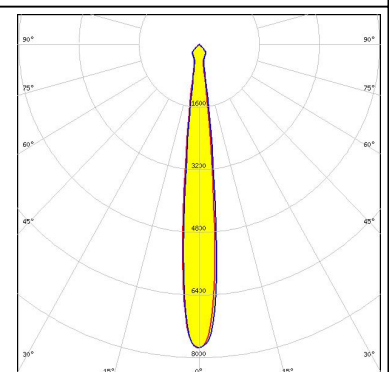

CITIZEN

LED CLU700/701/702
 FWHM 17.0°
 Efficiency 90 %
 Peak intensity 3.8 cd/lm
 LEDs/each optic 1
 Light colour White
 Required components:
 F15255_HEKLA-SOCKET-C
 C14658_BARBARA-RZ-LENS

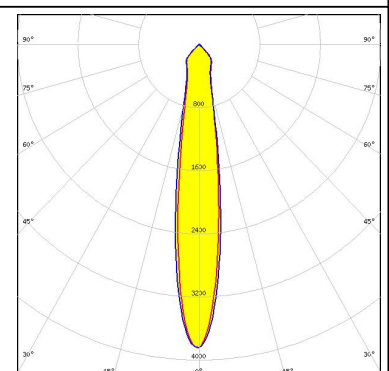

PHOTOMETRIC DATA (MEASURED):

CITIZEN

LED CLU7A2 (LES 4.2mm)
 FWHM 8.0°
 Efficiency 94 %
 Peak intensity 15.9 cd/lm
 LEDs/each optic 1
 Light colour White
 Required components:
 F15255_HEKLA-SOCKET-C

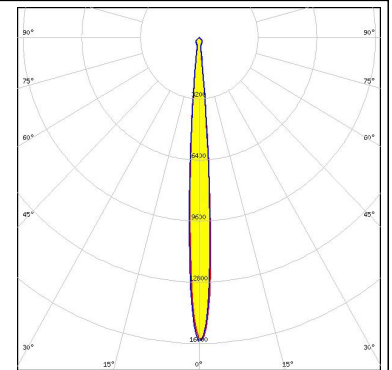

CITIZEN

LED LCN-C01B (Tunable White)
 FWHM 25.0°
 Efficiency 86 %
 Peak intensity 2.2 cd/lm
 LEDs/each optic 1
 Light colour White
 Required components:
 C16142_HEKLA-SOCKET-K
 C14658_BARBARA-RZ-LENS
 Bender Wirth: 481 Typ L8

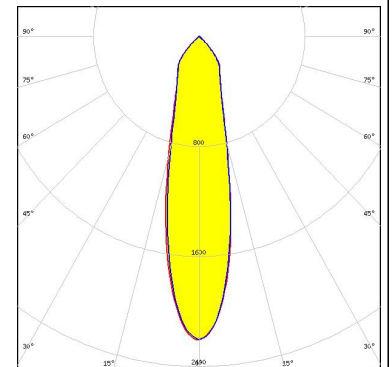
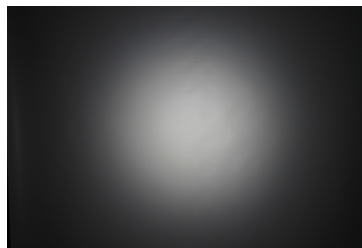

CITIZEN

LED LCN-C02B (Tunable White)
 FWHM 27.0°
 Efficiency 89 %
 Peak intensity 2.3 cd/lm
 LEDs/each optic 1
 Light colour White
 Required components:
 C16142_HEKLA-SOCKET-K

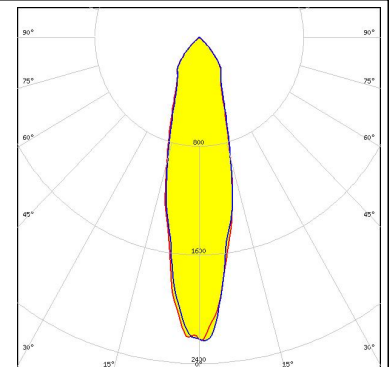
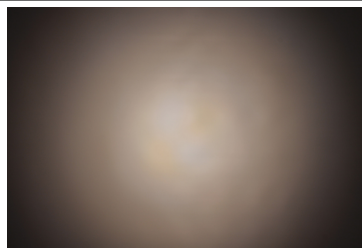

CITIZEN

LED LCN-C02B (Tunable White)
 FWHM 32.0°
 Efficiency 84 %
 Peak intensity 1.6 cd/lm
 LEDs/each optic 1
 Light colour White
 Required components:
 C16142_HEKLA-SOCKET-K
 C14658_BARBARA-RZ-LENS
 Bender Wirth: 481 Typ L8

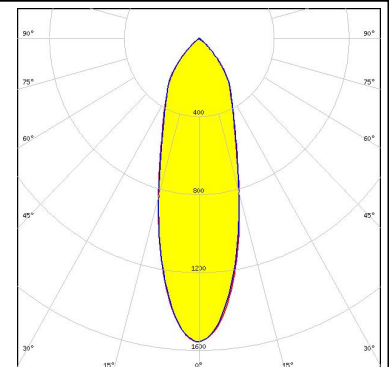
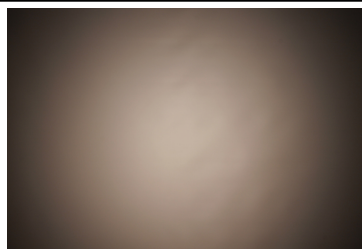

PHOTOMETRIC DATA (MEASURED):



LED CMA1516
 FWHM 18.0°
 Efficiency 94 %
 Peak intensity 4.2 cd/lm
 LEDs/each optic 1
 Light colour White
 Required components:
 F15256_HEKLA-SOCKET-D

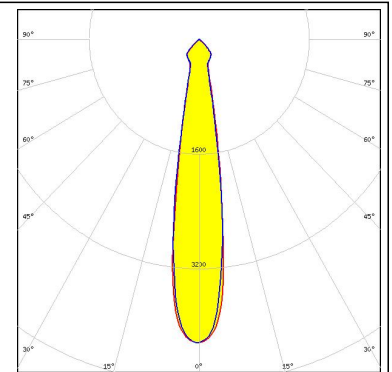

LED CMA1825
 FWHM 24.0°
 Efficiency 94 %
 Peak intensity 2.7 cd/lm
 LEDs/each optic 1
 Light colour White
 Required components:
 F15254_HEKLA-SOCKET-B

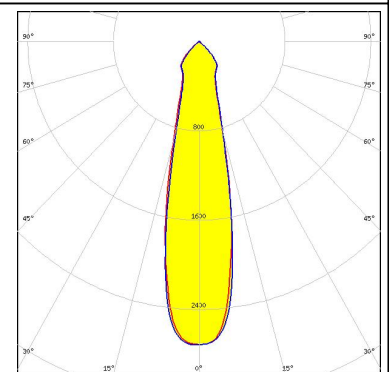
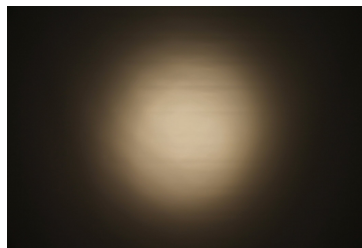

LED CMT14xx
 FWHM 19.0°
 Efficiency 95 %
 Peak intensity 3.8 cd/lm
 LEDs/each optic 1
 Light colour White
 Required components:
 F15255_HEKLA-SOCKET-C

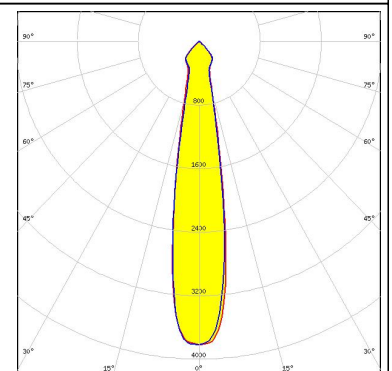
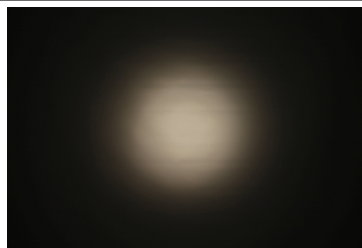

LED CXA/B 13xx
 FWHM 11.0°
 Efficiency 94 %
 Peak intensity 8.2 cd/lm
 LEDs/each optic 1
 Light colour White
 Required components:
 F15956_HEKLA-SOCKET-J

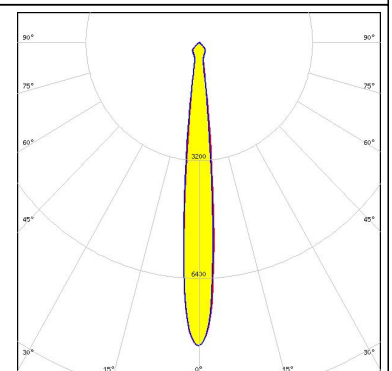

PHOTOMETRIC DATA (MEASURED):



LED CXA/B 15xx
 FWHM 16.0°
 Efficiency 94 %
 Peak intensity 4.4 cd/lm
 LEDs/each optic 1
 Light colour White
 Required components:
 F15256_HEKLA-SOCKET-D

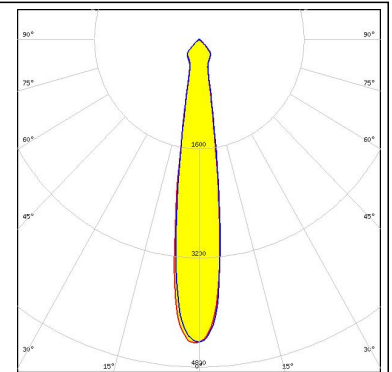

LED LUXEON CoB 1202HD
 FWHM 13.0°
 Efficiency 95 %
 Peak intensity 7.5 cd/lm
 LEDs/each optic 1
 Light colour White
 Required components:
 F15848_HEKLA-SOCKET-G

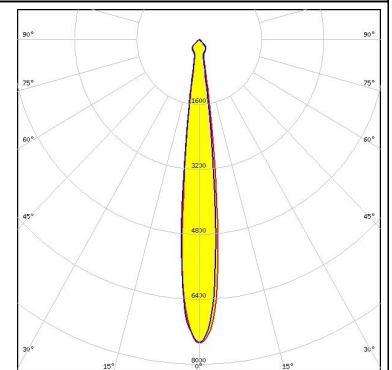
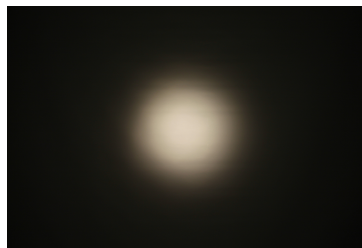



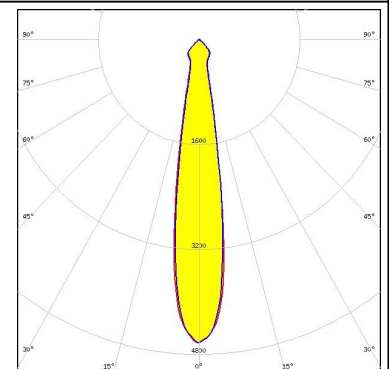
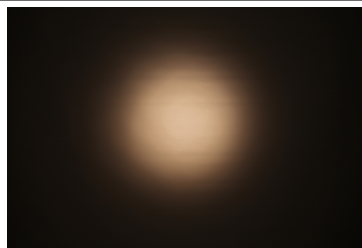

LED LUXEON CoB 1204HD
 FWHM 18.0°
 Efficiency 96 %
 Peak intensity 4.6 cd/lm
 LEDs/each optic 1
 Light colour White
 Required components:
 F15858_HEKLA-SOCKET-H

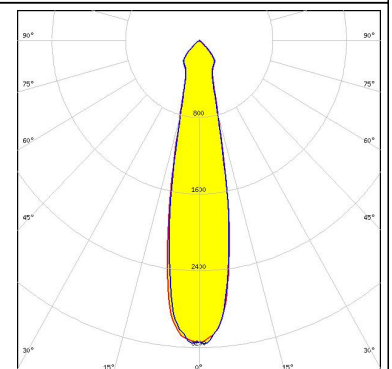
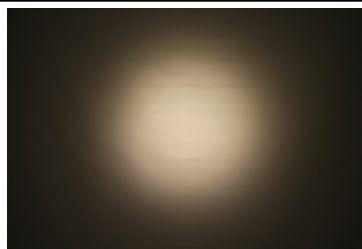

LED LUXEON CoB 1205HD
 FWHM 22.0°
 Efficiency 94 %
 Peak intensity 3.2 cd/lm
 LEDs/each optic 1
 Light colour White
 Required components:
 F15858_HEKLA-SOCKET-H

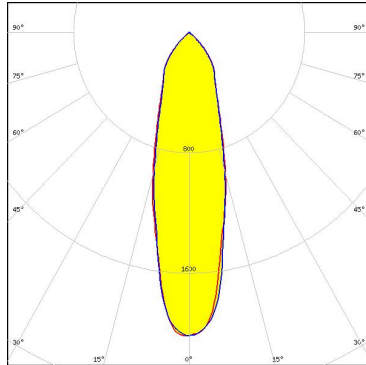
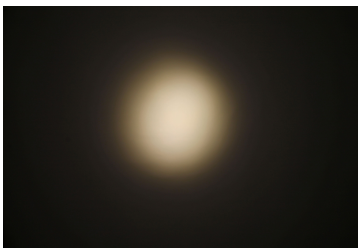
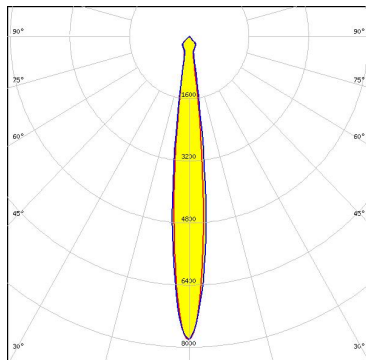

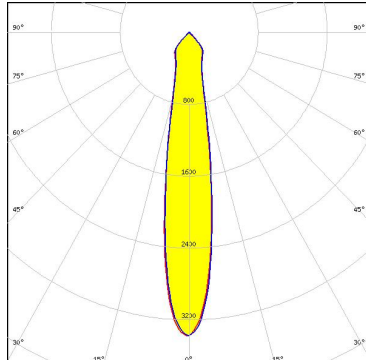
PHOTOMETRIC DATA (MEASURED):

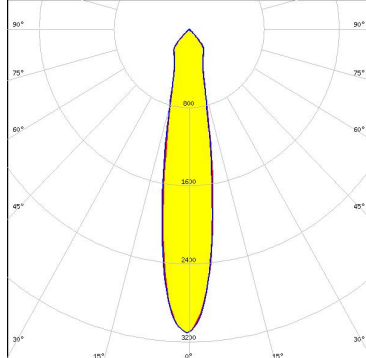
<p>LUMILEDS</p> <p>LED LUXEON CoB 1208</p> <p>FWHM 29.0°</p> <p>Efficiency 92 %</p> <p>Peak intensity 2 cd/lm</p> <p>LEDs/each optic 1</p> <p>Light colour White</p> <p>Required components: Bender Wirth: 632a Hekla XL</p>		
<p>LUMILEDS</p> <p>LED LUXEON CX Plus CoB - HD S01H4</p> <p>FWHM 13.0°</p> <p>Efficiency 93 %</p> <p>Peak intensity 7.8 cd/lm</p> <p>LEDs/each optic 1</p> <p>Light colour White</p> <p>Required components: Bender Wirth: 634c Hekla</p>		
<p>LUMILEDS</p> <p>LED LUXEON CX Plus CoB - HD S01H4</p> <p>FWHM 18.0°</p> <p>Efficiency 86 %</p> <p>Peak intensity 3.4 cd/lm</p> <p>LEDs/each optic 1</p> <p>Light colour White</p> <p>Required components: C14658_BARBARA-RZ-LENS Bender Wirth: 634c Hekla</p>		
<p>LUMILEDS</p> <p>LED LUXEON CX Plus CoB - HD S01H6 / HD S02H6</p> <p>FWHM 20.0°</p> <p>Efficiency 86 %</p> <p>Peak intensity 3.1 cd/lm</p> <p>LEDs/each optic 1</p> <p>Light colour White</p> <p>Required components: C14658_BARBARA-RZ-LENS Bender Wirth: 634c Hekla</p>		

PHOTOMETRIC DATA (MEASURED):

LUMILEDS

LED LUXEON CX Plus CoB - HD S01H6 / HD S02H6
 FWHM 14.0°
 Efficiency 93 %
 Peak intensity 7 cd/lm
 LEDs/each optic 1
 Light colour White
 Required components:
 Bender Wirth: 634c Hekla

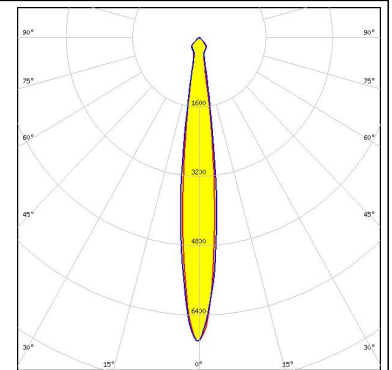
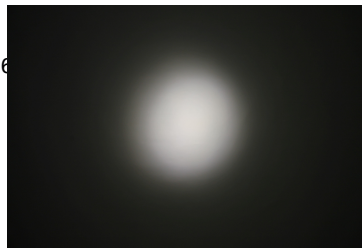

LUMILEDS

LED LUXEON CX Plus CoB - HD S04H9
 FWHM 23.0°
 Efficiency 86 %
 Peak intensity 2.4 cd/lm
 LEDs/each optic 1
 Light colour White
 Required components:
 C14658_BARBARA-RZ-LENS
 Bender Wirth: 634c Hekla

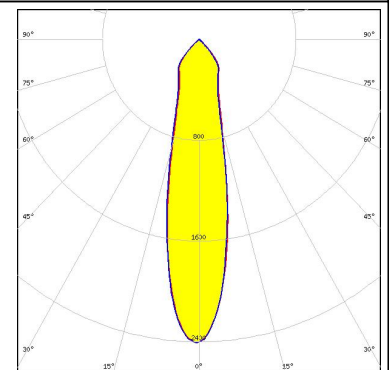
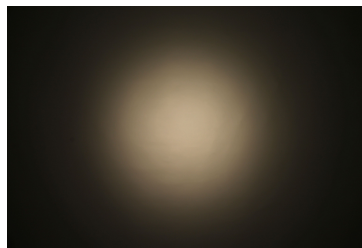

LUMILEDS

LED LUXEON CX Plus CoB - HD S04H9
 FWHM 18.0°
 Efficiency 93 %
 Peak intensity 4 cd/lm
 LEDs/each optic 1
 Light colour White
 Required components:
 Bender Wirth: 634c Hekla

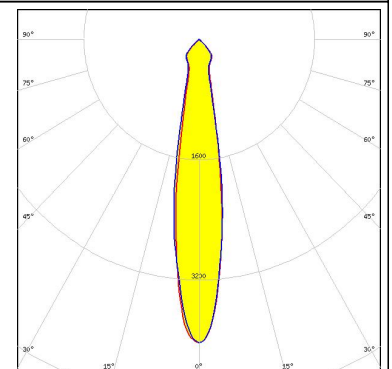
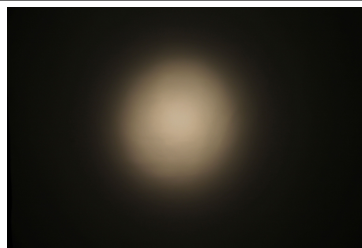

LUMINUS

LED CDM-14 (Dim-To-Warm)
 FWHM 28.0°
 Efficiency 83 %
 Peak intensity 1.8 cd/lm
 LEDs/each optic 1
 Light colour White
 Required components:
 C16142_HEKLA-SOCKET-K
 C14658_BARBARA-RZ-LENS
 Bender Wirth: 491 Typ L8

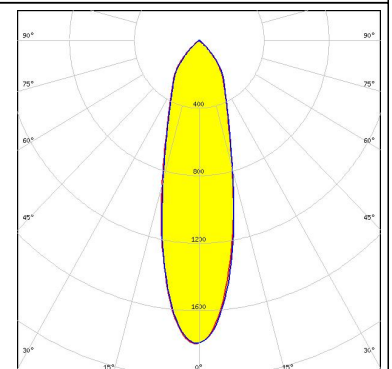
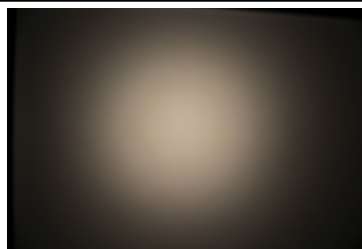

PHOTOMETRIC DATA (MEASURED):

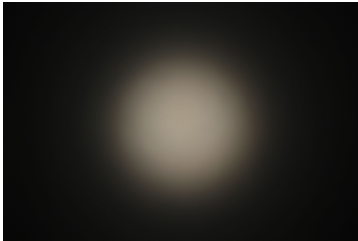
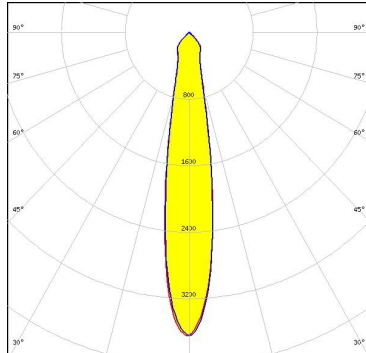
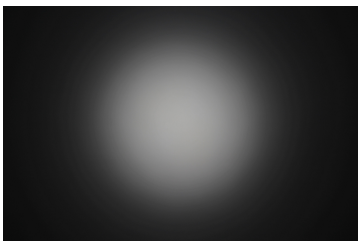
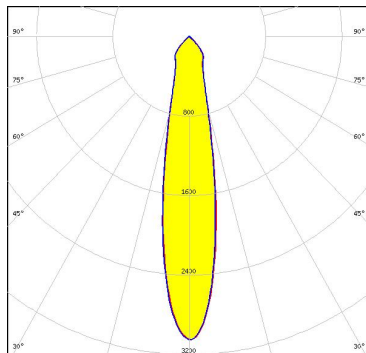
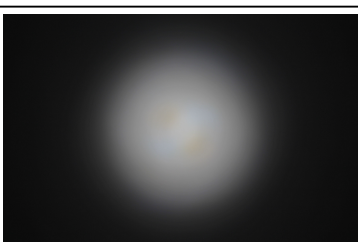
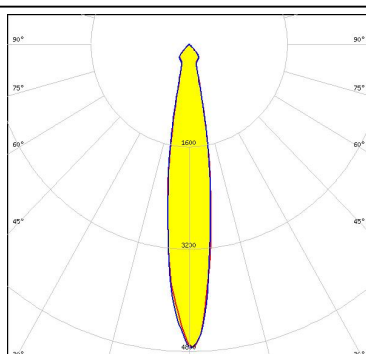
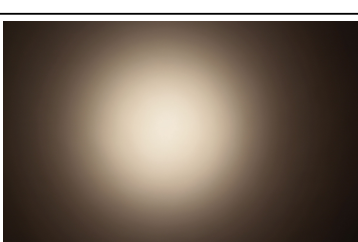
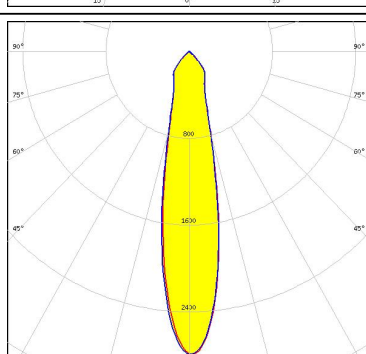
<p>LUMINUS</p> <p>LED CDM-6 (Dim-To-Warm)</p> <p>FWHM 18.0°</p> <p>Efficiency 86 %</p> <p>Peak intensity 3.6 cd/lm</p> <p>LEDs/each optic 1</p> <p>Light colour White</p> <p>Required components: C16142_HEKLA-SOCKET-K C14658_BARBARA-RZ-LENS Bender Wirth: 490 Typ L8</p>		
<p>LUMINUS</p> <p>LED CDM-9 (Dim-To-Warm)</p> <p>FWHM 21.0°</p> <p>Efficiency 85 %</p> <p>Peak intensity 3.1 cd/lm</p> <p>LEDs/each optic 1</p> <p>Light colour White</p> <p>Required components: C16142_HEKLA-SOCKET-K C14658_BARBARA-RZ-LENS Bender Wirth: 490 Typ L8</p>		
<p>LUMINUS</p> <p>LED CDM-9 (Dim-To-Warm)</p> <p>FWHM 17.0°</p> <p>Efficiency 90 %</p> <p>Peak intensity 4.8 cd/lm</p> <p>LEDs/each optic 1</p> <p>Light colour White</p> <p>Required components: C16142_HEKLA-SOCKET-K Bender Wirth: 490 Typ L8</p>		
<p>LUMINUS</p> <p>LED CTM-9 (Tunable White)</p> <p>FWHM 22.0°</p> <p>Efficiency 85 %</p> <p>Peak intensity 2.8 cd/lm</p> <p>LEDs/each optic 1</p> <p>Light colour White</p> <p>Required components: C16142_HEKLA-SOCKET-K C14658_BARBARA-RZ-LENS Bender Wirth: 495 Typ L8</p>		

PHOTOMETRIC DATA (MEASURED):



LED CxM-14 (19x19)
 FWHM 29.0°
 Efficiency 94 %
 Peak intensity 2.1 cd/lm
 LEDs/each optic 1
 Light colour White
 Required components:
 F15859_HEKLA-SOCKET-I

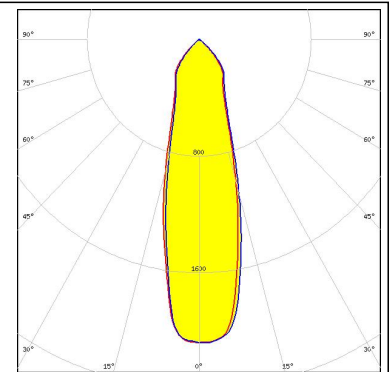

LED CXM-4
 FWHM 14.0°
 Efficiency 89 %
 Peak intensity 4.9 cd/lm
 LEDs/each optic 1
 Light colour White
 Required components:
 F15255_HEKLA-SOCKET-C
 C14658_BARBARA-RZ-LENS

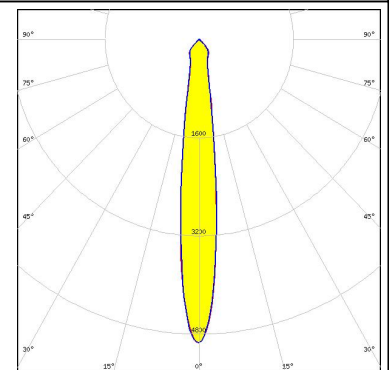

LED CXM-4
 FWHM 9.0°
 Efficiency 94 %
 Peak intensity 13.6 cd/lm
 LEDs/each optic 1
 Light colour White
 Required components:
 F15255_HEKLA-SOCKET-C

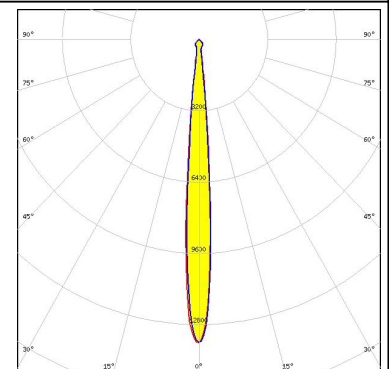

LED CxM-9 (13.5x13.5)
 FWHM 18.0°
 Efficiency 94 %
 Peak intensity 3.9 cd/lm
 LEDs/each optic 1
 Light colour White
 Required components:
 F15255_HEKLA-SOCKET-C

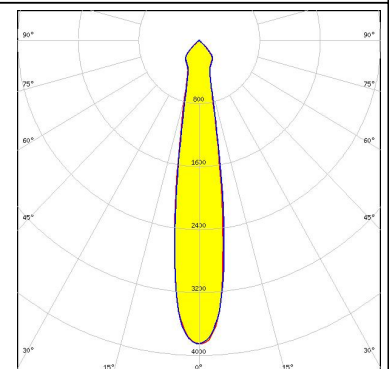

PHOTOMETRIC DATA (MEASURED):



LED NJCWL024Z-V1MT: COB L-Type Tunable White
 FWHM 18.0°
 Efficiency 81 %
 Peak intensity 3.1 cd/lm
 LEDs/each optic 1
 Light colour White
 Required components:
 C16142_HEKLA-SOCKET-K
 C14658_BARBARA-RZ-LENS
 Bender Wirth: 497 Typ L8

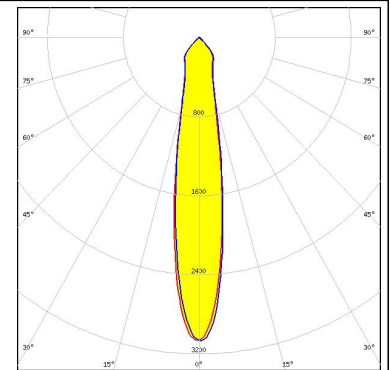

LED NJCWL024Z-V1MT: COB L-Type Tunable White
 FWHM 15.0°
 Efficiency 86 %
 Peak intensity 5.1 cd/lm
 LEDs/each optic 1
 Light colour White
 Required components:
 C16142_HEKLA-SOCKET-K
 Bender Wirth: 497 Typ L8

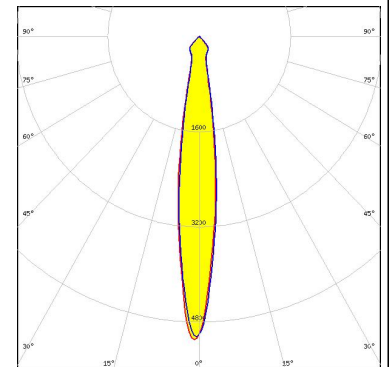
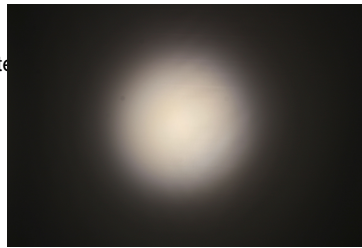

LED NVCWJ024Z-V1MT: COB J-Type Tunable White
 FWHM 25.0°
 Efficiency 85 %
 Peak intensity 2.2 cd/lm
 LEDs/each optic 1
 Light colour White
 Required components:
 C16142_HEKLA-SOCKET-K
 C14658_BARBARA-RZ-LENS
 Bender Wirth: 498 Typ L2

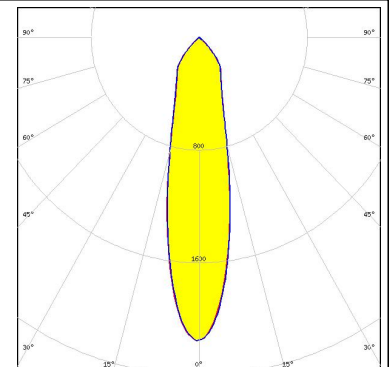
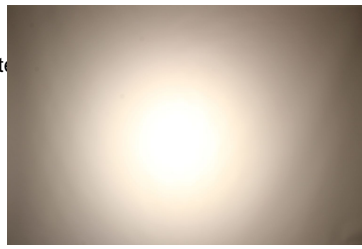

LED Fortimo SLM L09 CoB
 FWHM 21.0°
 Efficiency 89 %
 Peak intensity 2.8 cd/lm
 LEDs/each optic 1
 Light colour White
 Required components:
 F15858_HEKLA-SOCKET-H
 C14658_BARBARA-RZ-LENS

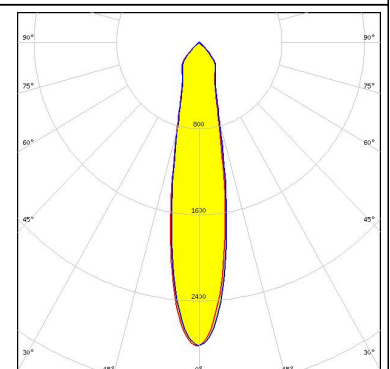
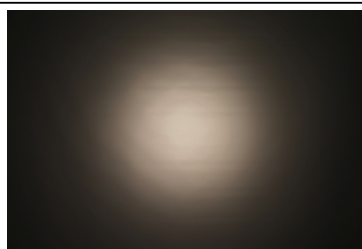

PHOTOMETRIC DATA (MEASURED):

PHILIPS

LED Fortimo SLM L09 CoB
FWHM 18.0°
Efficiency 94 %
Peak intensity 4.2 cd/lm
LEDs/each optic 1
Light colour White
Required components:
F15858_HEKLA-SOCKET-H

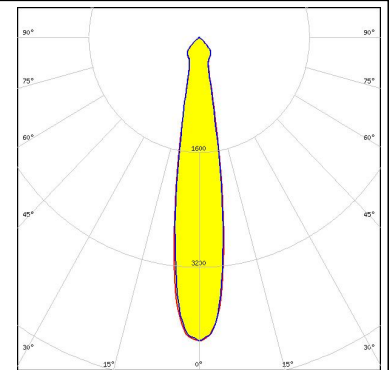

PHILIPS

LED Fortimo SLM L13 CoB
FWHM 32.0°
Efficiency 85 %
Peak intensity 1.6 cd/lm
LEDs/each optic 1
Light colour White
Required components:
C16142_HEKLA-SOCKET-K
C14658_BARBARA-RZ-LENS
Bender Wirth: 432 Typ L8

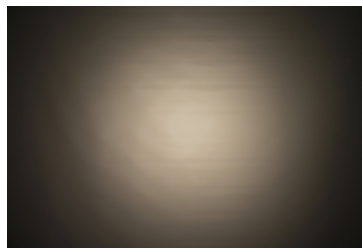

PHILIPS

LED Fortimo SLM L13 CoB
FWHM 27.0°
Efficiency 89 %
Peak intensity 2.1 cd/lm
LEDs/each optic 1
Light colour White
Required components:
C16142_HEKLA-SOCKET-K
Bender Wirth: 432 Typ L8

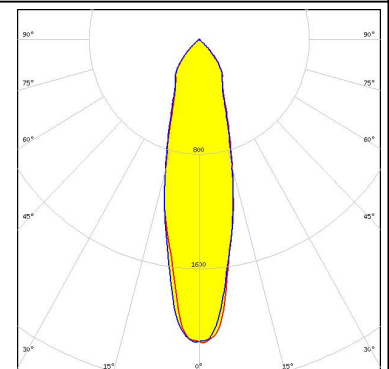
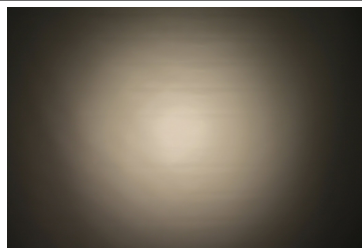

SAMSUNG

LED LC003D / LC006D / LC009D / LC013D
FWHM 18.0°
Efficiency 94 %
Peak intensity 4.3 cd/lm
LEDs/each optic 1
Light colour White
Required components:
F15255_HEKLA-SOCKET-C

PHOTOMETRIC DATA (MEASURED):

SAMSUNG

LED LC003D / LC006D / LC009D / LC013D
 FWHM 22.0°
 Efficiency 90 %
 Peak intensity 2.8 cd/lm
 LEDs/each optic 1
 Light colour White
 Required components:
 F15255_HEKLA-SOCKET-C
 C14658_BARBARA-RZ-LENS

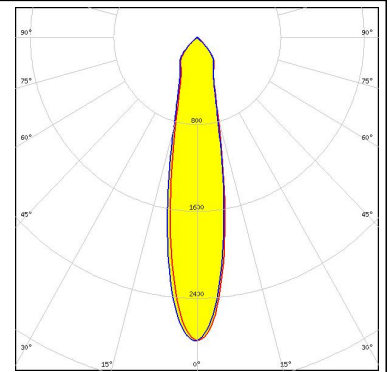

SAMSUNG

LED LC003D / LC006D / LC009D / LC013D
 FWHM 18.0°
 Efficiency 94 %
 Peak intensity 4.3 cd/lm
 LEDs/each optic 1
 Light colour White
 Required components:
 F15255_HEKLA-SOCKET-C

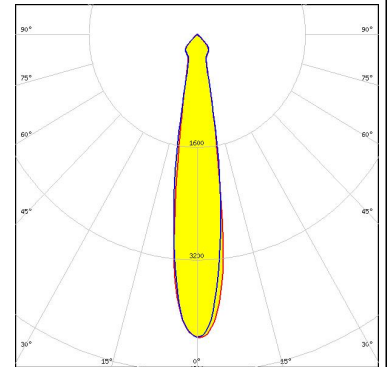

SAMSUNG

LED LC010C G2
 FWHM 11.0°
 Efficiency 93 %
 Peak intensity 9 cd/lm
 LEDs/each optic 1
 Light colour White
 Required components:
 F15255_HEKLA-SOCKET-C

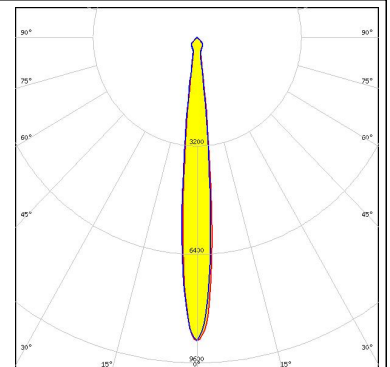

SAMSUNG

LED LC010T (Tunable White)
 FWHM 23.0°
 Efficiency 86 %
 Peak intensity 2.5 cd/lm
 LEDs/each optic 1
 Light colour Tunable White
 Required components:
 C16142_HEKLA-SOCKET-K
 C14658_BARBARA-RZ-LENS
 Bender Wirth: 501 Typ L8

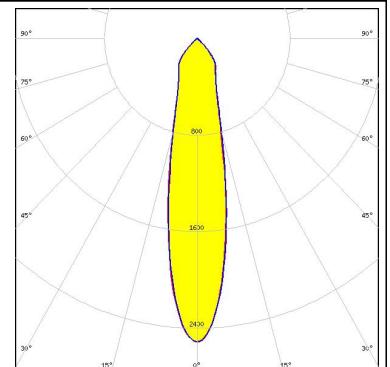

PHOTOMETRIC DATA (MEASURED):

SAMSUNG

LED LC010T (Tunable White)
 FWHM 18.0°
 Efficiency 91 %
 Peak intensity 3.9 cd/lm
 LEDs/each optic 1
 Light colour Tunable White
 Required components:
 C16142_HEKLA-SOCKET-K
 Bender Wirth: 501 Typ L8

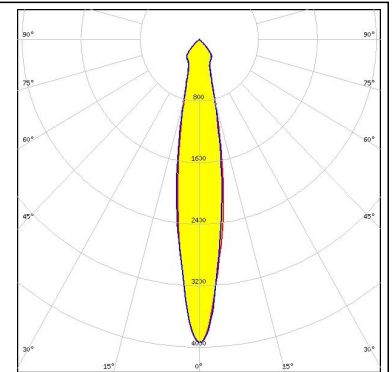
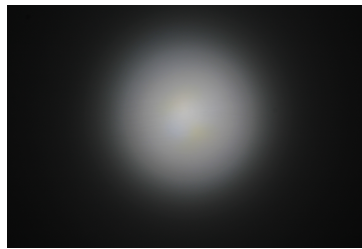

SAMSUNG

LED LC020C G2
 FWHM 17.0°
 Efficiency 94 %
 Peak intensity 4.6 cd/lm
 LEDs/each optic 1
 Light colour White
 Required components:
 F15859_HEKLA-SOCKET-I

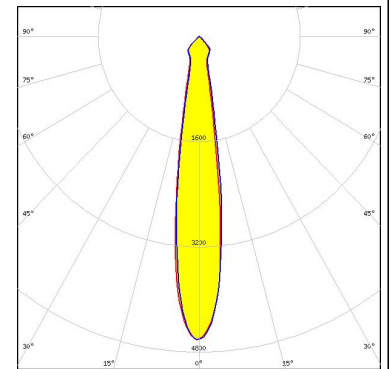

SAMSUNG

LED LC020T (Tunable white)
 FWHM 31.0°
 Efficiency 85 %
 Peak intensity 1.6 cd/lm
 LEDs/each optic 1
 Light colour Tunable White
 Required components:
 C16142_HEKLA-SOCKET-K
 C14658_BARBARA-RZ-LENS
 Bender Wirth: 501 Typ L8

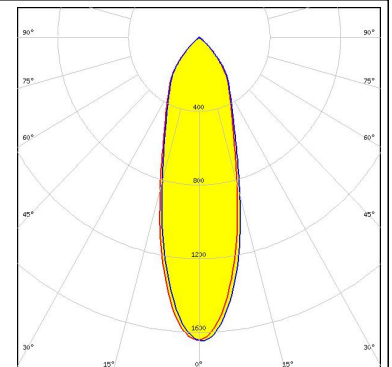
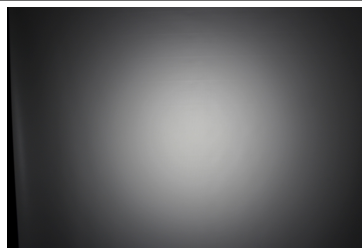



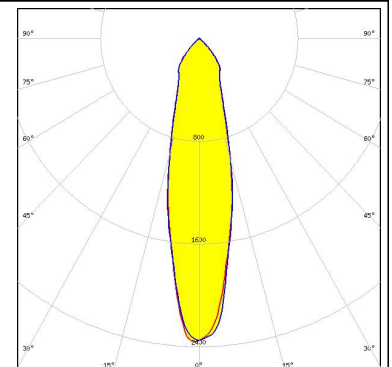
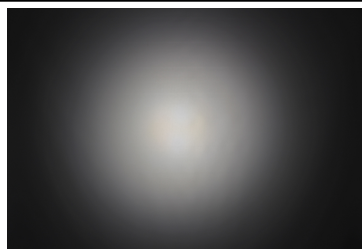

SAMSUNG

LED LC020T (Tunable white)
 FWHM 26.0°
 Efficiency 90 %
 Peak intensity 2.4 cd/lm
 LEDs/each optic 1
 Light colour Tunable White
 Required components:
 C16142_HEKLA-SOCKET-K
 Bender Wirth: 501 Typ L8

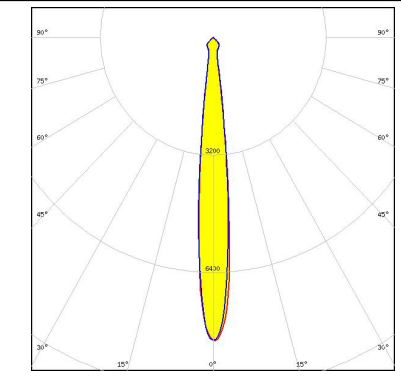
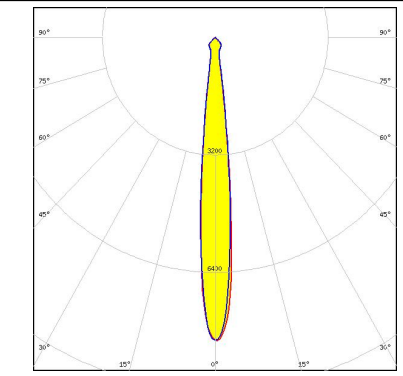
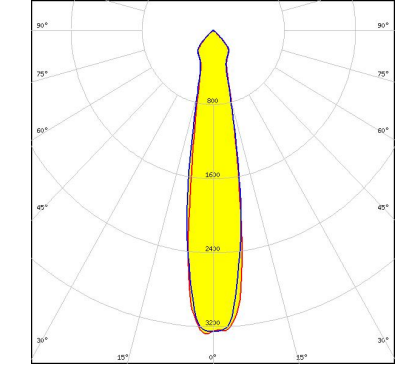

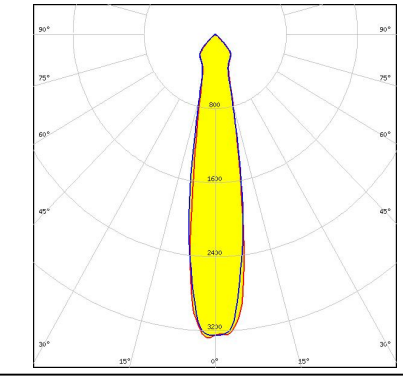
PHOTOMETRIC DATA (MEASURED):

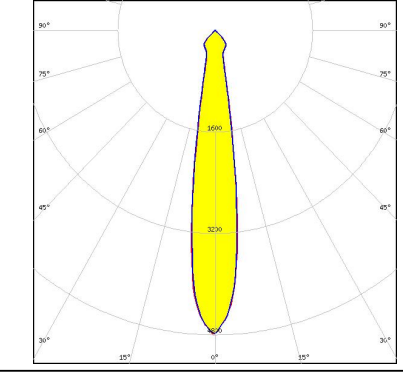
<p>SEOL SEOUL SEMICONDUCTOR</p> <p>LED MJT COB LES 6 FWHM 11.0° Efficiency 93 % Peak intensity 8.3 cd/lm LEDs/each optic 1 Light colour White Required components: F15255_HEKLA-SOCKET-C</p>		
<p>SEOL SEOUL SEMICONDUCTOR</p> <p>LED MJT COB LES 9.8 FWHM 20.0° Efficiency 92 % Peak intensity 3.3 cd/lm LEDs/each optic 1 Light colour White Required components: F15255_HEKLA-SOCKET-C</p>		
<p>TRIDONIC</p> <p>LED SLE G7 LES09 FWHM 17.0° Efficiency 94 % Peak intensity 4.8 cd/lm LEDs/each optic 1 Light colour White Required components: F15255_HEKLA-SOCKET-C</p>		
<p>TRIDONIC</p> <p>LED SLE G7 LES09 FWHM 20.0° Efficiency 91 % Peak intensity 3.1 cd/lm LEDs/each optic 1 Light colour White Required components: F15255_HEKLA-SOCKET-C C14658_BARBARA-RZ-LENS</p>		

PHOTOMETRIC DATA (MEASURED):

TRIDONIC

LED SLE G7 LES13
 FWHM 29.0°
 Efficiency 87 %
 Peak intensity 1.8 cd/lm
 LEDs/each optic 1
 Light colour White
 Required components:
 F15859_HEKLA-SOCKET-I
 C14658_BARBARA-RZ-LENS

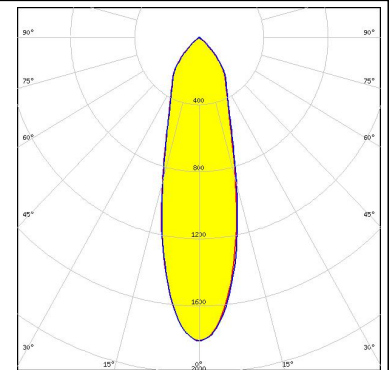

TRIDONIC

LED SLE G7 LES13
 FWHM 26.0°
 Efficiency 94 %
 Peak intensity 2.5 cd/lm
 LEDs/each optic 1
 Light colour White
 Required components:
 F15859_HEKLA-SOCKET-I

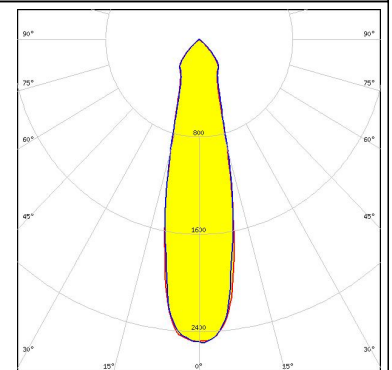
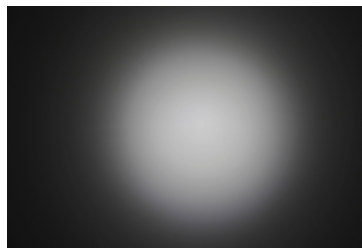

TRIDONIC

LED SLE G7 LES15
 FWHM 28.0°
 Efficiency 94 %
 Peak intensity 2.2 cd/lm
 LEDs/each optic 1
 Light colour White
 Required components:
 F15859_HEKLA-SOCKET-I

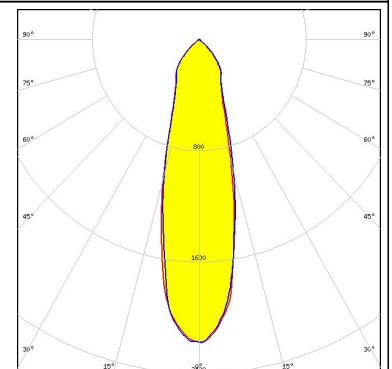
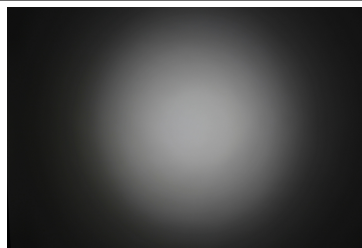

XICATO

LED XOB 14.5 mm
 FWHM 27.0°
 Efficiency 94 %
 Peak intensity 2.2 cd/lm
 LEDs/each optic 1
 Light colour White
 Required components:
 F15859_HEKLA-SOCKET-I

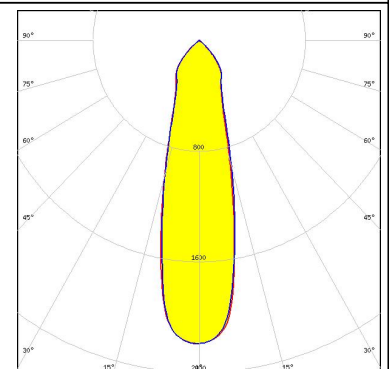
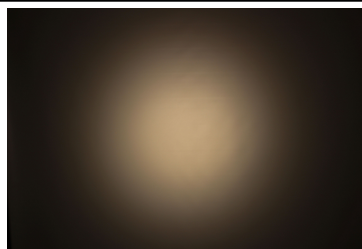

PHOTOMETRIC DATA (MEASURED):

XICATO

LED XOB 6 mm
 FWHM 15.0°
 Efficiency 88 %
 Peak intensity 4.2 cd/lm
 LEDs/each optic 1
 Light colour White
 Required components:
 F15255_HEKLA-SOCKET-C
 C14658_BARBARA-RZ-LENS

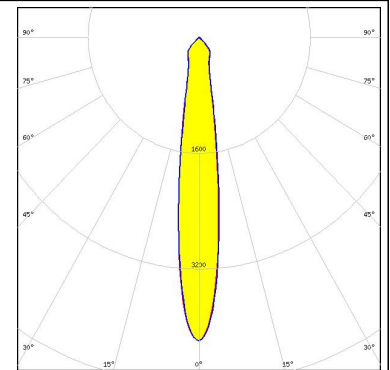

XICATO

LED XOB 6 mm
 FWHM 11.0°
 Efficiency 94 %
 Peak intensity 8.7 cd/lm
 LEDs/each optic 1
 Light colour White
 Required components:
 F15255_HEKLA-SOCKET-C

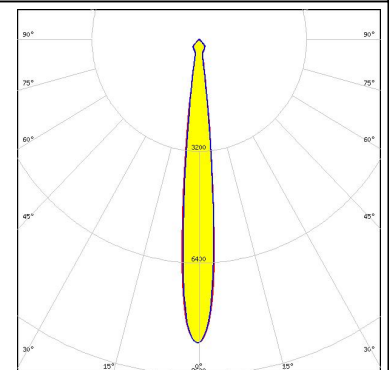

XICATO

LED XOB 9.8 mm
 FWHM 21.0°
 Efficiency 90 %
 Peak intensity 2.9 cd/lm
 LEDs/each optic 1
 Light colour White
 Required components:
 F15255_HEKLA-SOCKET-C
 C14658_BARBARA-RZ-LENS

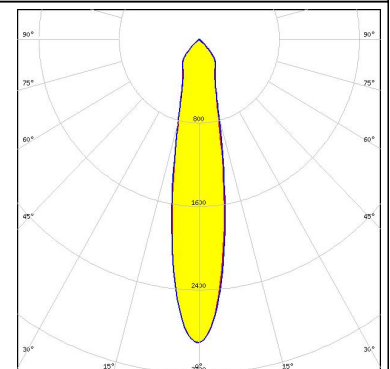
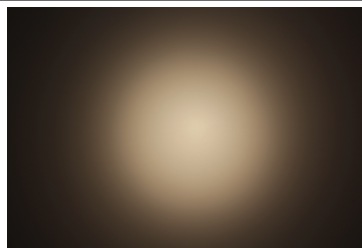

XICATO

LED XOB 9.8 mm
 FWHM 16.0°
 Efficiency 94 %
 Peak intensity 4.6 cd/lm
 LEDs/each optic 1
 Light colour White
 Required components:
 F15255_HEKLA-SOCKET-C

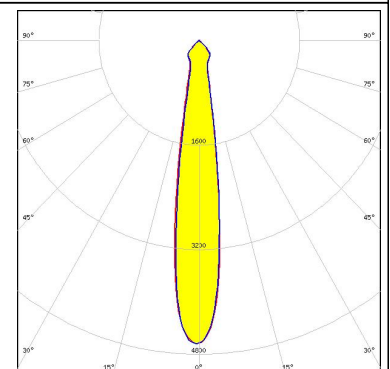

PHOTOMETRIC DATA (MEASURED):

XICATO

LED XTM - 19mm LES
FWHM 33.0°
Efficiency 92 %
Peak intensity 1.7 cd/lm
LEDs/each optic 1
Light colour White
Required components:
C15743_XTM-ADAPTER-50-B

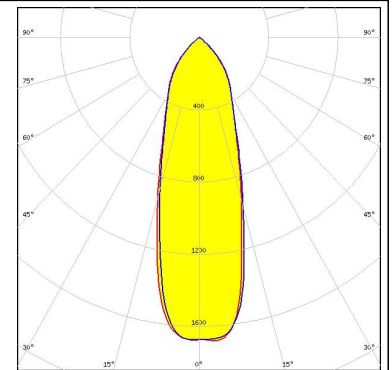



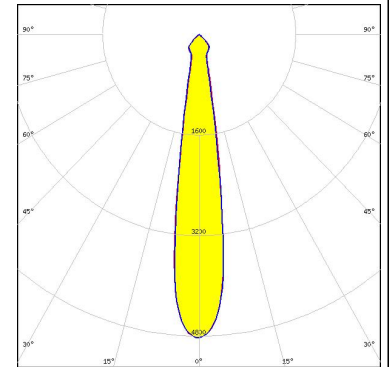

XICATO

LED XTM - 9mm LES
FWHM 17.0°
Efficiency 94 %
Peak intensity 4.8 cd/lm
LEDs/each optic 1
Light colour White
Required components:
C15743_XTM-ADAPTER-50-B

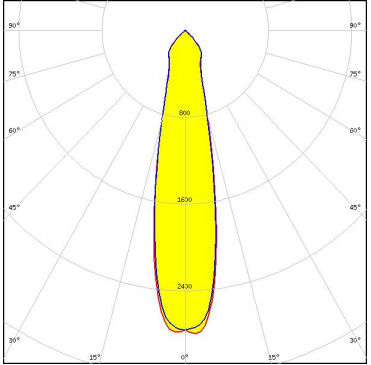

PHOTOMETRIC DATA (SIMULATED):

		
LED	V10 Gen6	
FWHM	15.0°	
Efficiency	0 %	
LEDs/each optic	1	
Light colour	White	
Required components:		
F14988_HEKLA-SOCKET-E		
		
LED	V10 Gen6	
FWHM	15.0°	
Efficiency	%	
LEDs/each optic	1	
Light colour	White	
Required components:		
F14988_HEKLA-SOCKET-E		
		
LED	V13 Gen6	
FWHM	24.0°	
Efficiency	92 %	
Peak intensity	2.8 cd/lm	
LEDs/each optic	1	
Light colour	White	
Required components:		
F14988_HEKLA-SOCKET-E		
		
LED	V8 Gen6	
FWHM	15.0°	
Efficiency	0 %	
LEDs/each optic	1	
Light colour	White	
Required components:		
F15253_HEKLA-SOCKET-A		

PHOTOMETRIC DATA (SIMULATED):

bridgelux.

LED	V8 Gen6
FWHM	15.0°
Efficiency	0 %
LEDs/each optic	1
Light colour	White
Required components:	
F15253_HEKLA-SOCKET-A	

bridgelux.

LED	Vesta TW 9mm (9W) DP
FWHM	18.0°
Efficiency	87 %
Peak intensity	3.5 cd/lm
LEDs/each optic	1
Light colour	White
Required components:	
C16142_HEKLA-SOCKET-K	
C14658_BARBARA-RZ-LENS	
Bender Wirth: 489 Typ L8	

CITIZEN

LED	CLL02x/CLU02x (LES10)
FWHM	18.0°
Efficiency	92 %
Peak intensity	4.3 cd/lm
LEDs/each optic	1
Light colour	White
Required components:	
F15255_HEKLA-SOCKET-C	

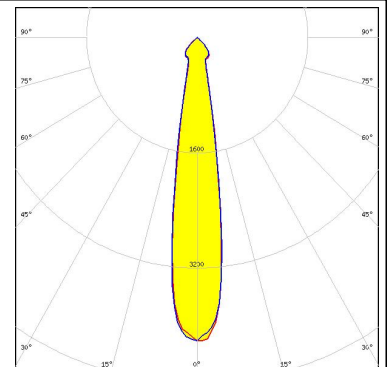

CITIZEN

LED	CLL03x/CLU03x
FWHM	31.0°
Efficiency	93 %
Peak intensity	1.9 cd/lm
LEDs/each optic	1
Light colour	White
Required components:	
F15859_HEKLA-SOCKET-I	

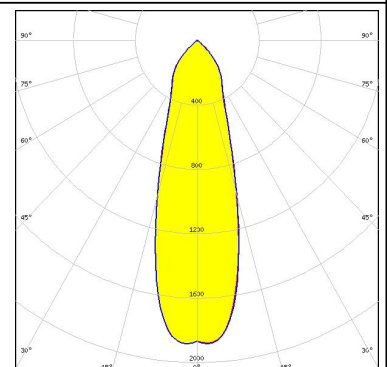

PHOTOMETRIC DATA (SIMULATED):



LED CMT14xx
FWHM 17.0°
Efficiency 90 %
Peak intensity 4.2 cd/lm
LEDs/each optic 1
Light colour White
Required components:
F15255_HEKLA-SOCKET-C

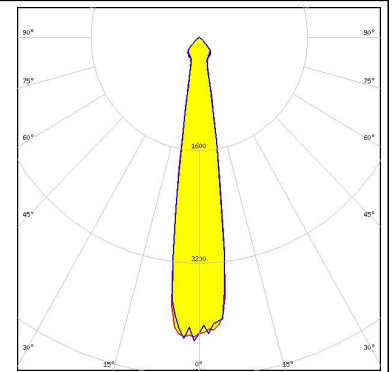

LED CXA/B 15xx
FWHM 15.0°
Efficiency 0 %
LEDs/each optic 1
Light colour White
Required components:
F15256_HEKLA-SOCKET-D



LED CXA/B 1816 & CXA/B 1820 & CXA 1850
FWHM 22.0°
Efficiency 0 %
LEDs/each optic 1
Light colour White
Required components:
F15254_HEKLA-SOCKET-B



LED CXA/B 1816 & CXA/B 1820 & CXA 1850
FWHM 22.0°
Efficiency %
LEDs/each optic 1
Light colour White
Required components:
F15254_HEKLA-SOCKET-B

PHOTOMETRIC DATA (SIMULATED):

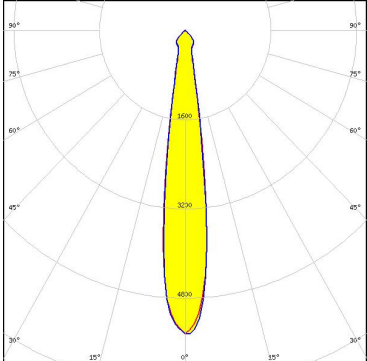
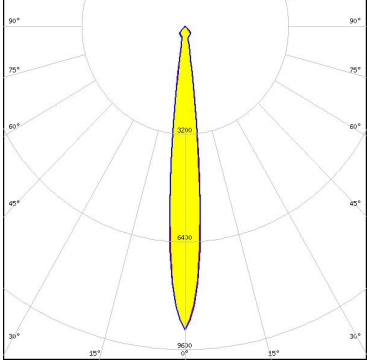
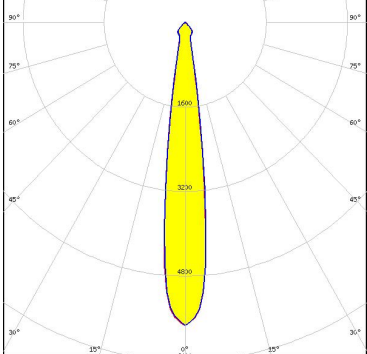
<p>NICHIA</p> <p>LED COB L-Type (LES 11) FWHM 20.0° Efficiency 93 % Peak intensity 3.3 cd/lm LEDs/each optic 1 Light colour White Required components: F15858_HEKLA-SOCKET-H</p>	
<p>NICHIA</p> <p>LED COB L-Type (LES 9) FWHM 16.0° Efficiency 93 % Peak intensity 5.4 cd/lm LEDs/each optic 1 Light colour White Required components: F15858_HEKLA-SOCKET-H</p>	
<p>NICHIA</p> <p>LED COB T-Type FWHM 12.0° Efficiency 91 % Peak intensity 9 cd/lm LEDs/each optic 1 Light colour White Required components: F15848_HEKLA-SOCKET-G</p>	
<p>NICHIA</p> <p>LED NFSWE11A FWHM 14.0° Efficiency 86 % Peak intensity 5.7 cd/lm LEDs/each optic 30 Light colour White Required components: C16142_HEKLA-SOCKET-K</p>	

PHOTOMETRIC DATA (SIMULATED):

OSRAM

Opto Semiconductors

LED Soleriq S13 19x19
 FWHM 23.9°
 Efficiency 93 %
 Peak intensity 2.7 cd/lm
 LEDs/each optic 1
 Light colour White
 Required components:
 F15859_HEKLA-SOCKET-I

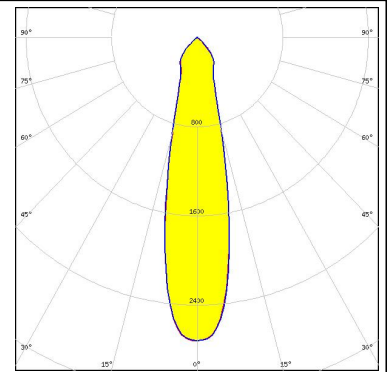

OSRAM

Opto Semiconductors

LED Soleriq S9
 FWHM 17.4°
 Efficiency 93 %
 Peak intensity 4.4 cd/lm
 LEDs/each optic 1
 Light colour White
 Required components:
 F15255_HEKLA-SOCKET-C

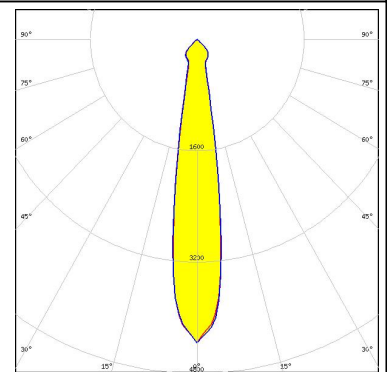

SAMSUNG

LED LC016D / LC019D / LC026D / LC033D
 FWHM 29.0°
 Efficiency 88 %
 Peak intensity 1.9 cd/lm
 LEDs/each optic 1
 Light colour White
 Required components:
 F15859_HEKLA-SOCKET-I

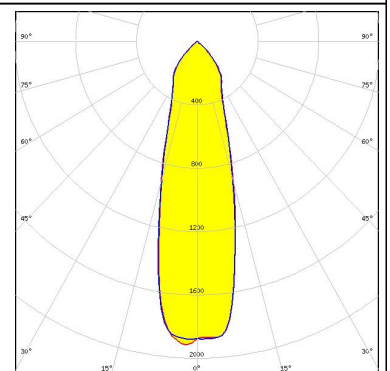

GENERAL INFORMATION:

NOTE: The typical beam angle will be changed by different color, chip size and chip position tolerance. The typical total beam angle is the full angle measured where the luminous intensity is half of the peak value.

Due to use of high power COB's with this product, special attention to proper thermal design is highly recommended. LEDiL has no liability for direct, indirect or consecutive damages arising from the LEDiL products being used outside of the recommended temperature range.

MATERIALS:

As part of our continuous research and improvement processes, and to ensure the best possible quality and availability of our products, LEDiL reserves the right to change material grades without notice.

PRODUCT DATA USER AGREEMENT AND DISCLAIMER:

The measured data in the provided downloadable LEDiL Product Datasheets and Mechanical 2D-Drawings is rounded and provided as reference for planning. LEDiL Oy's optical specifications have been verified by conducting performance testing of the products in accordance with the company's quality system. The reported data are averaged results of multiple measurements with typical variation. LEDiL Oy reserves the right to without prior notification make changes and improvements to its products.

LEDiL Oy assumes neither warranty, nor guarantee nor any other liability of any kind for the contents and correctness of the provided data. The provided data has been generated with highest diligence but the provided data may in reality not represent the complete possible variation range of all intrinsic parameters. Therefore, in certain cases a deviation from the provided data could occur.

LEDiL Oy reserves the right to undertake technical changes of its products without further notification which could lead to changes in the provided data. LEDiL Oy assumes no liability of any kind for the possible deviation from any provided data or any other damage resulting from the usage of the provided data.

The user agrees to this disclaimer and user agreement with the download or usage of the provided files.

LEDiL Oy

Joensuunkatu 13
FI-24240 SALO
Finland

LEDiL Inc.

228 West Page Street
Suite D
Sycamore IL 60178
USA

Local sales and technical support

www.ledil.com/where_to_buy

Shipping locations

Salo, Finland
Hong Kong, China

Distribution Partners

www.ledil.com/where_to_buy