

Chip beads
For power line
Soft termination
KPZ-HR series (for automotive)



AEC-Q200

KPZ1608-HR type



FEATURES

- Noise reduction solution for power line.
- Compared to the KMZ series, has low direct current resistance for compatibility with large currents, optimal for low power consumption.
- Guide electric property resin absorbs external stress, and mechanical stress, resistance force to thermal shock is improved.
- Easing by conductive resin thermal stress, and respond for High-temperature environment of 150°C, too.
- Operating temperature range: -55 to +150°C
- Compliant with AEC-Q200

APPLICATION

- Various ECUs, powertrains, body controls, and car multimedia (telematics).

PART NUMBER CONSTRUCTION

KPZ	1608	S	HR	121	A	T	DH5
Series name	LxWxT dimensions 1.6x0.8x0.6 mm 1.6x0.8x0.8 mm	Material name	Specifications (Grade)	Impedance (Ω) at 100MHz	Characteristic type	Packaging style	Internal code

CHARACTERISTICS SPECIFICATION TABLE

Impedance [100MHz] (Ω)	DC resistance (Ω)max.	Rated current* (A)max.	Thickness T (mm)	Part No.
30	±10Ω	5.0	0.6	KPZ1608SHR300ATDH5
120	±25%	2.0	0.6	KPZ1608SHR121ATDH5
220	±25%	2.2	0.8	KPZ1608SHR221ATD25
600	±25%	1	0.8	KPZ1608SHR601ATD25
1000	±25%	0.8	0.8	KPZ1608SHR102ATD25

* Please refer to the graph of rated current vs. temperature characteristics (derating) about the rating current at 85°C or more in temperature of the product.

Measurement equipment

Measurement item	Product No.	Manufacturer
Impedance	E4991A+16192A	Keysight Technologies
DC resistance	Type-7556	Yokogawa

* Equivalent measurement equipment may be used.

Rated current vs. temperature characteristics (derating)

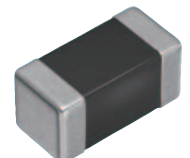
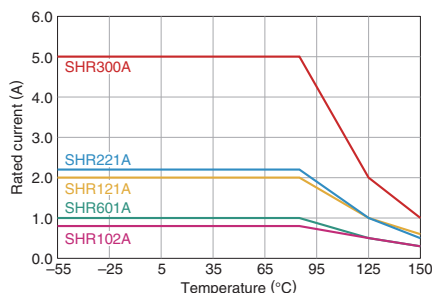

⚠ Please be sure to request delivery specifications that provide further details on the features and specifications of the products for proper and safe use. (1/4)
Please note that the contents may change without any prior notice due to reasons such as upgrading.

20190422

beads_automotive_power_kpz1608-hr_en

KPZ1608-HR type

Z VS. FREQUENCY CHARACTERISTICS (BY SERIES)

KPZ1608-SHR series

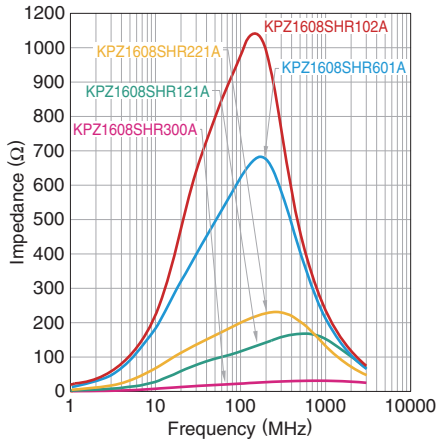

Z, X, R VS. FREQUENCY CHARACTERISTICS

KPZ1608SHR300ATDH5

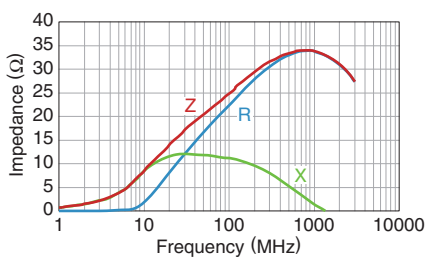

KPZ1608SHR121ATDH5

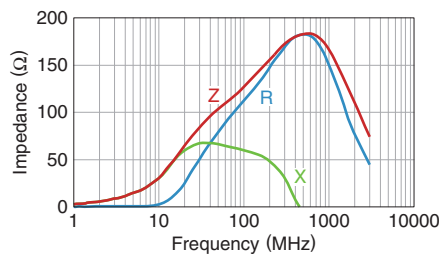

KPZ1608SHR221ATD25

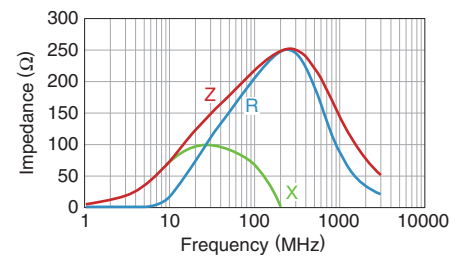

KPZ1608SHR601ATD25

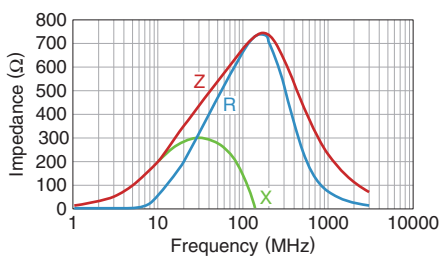

KPZ1608SHR102ATD25

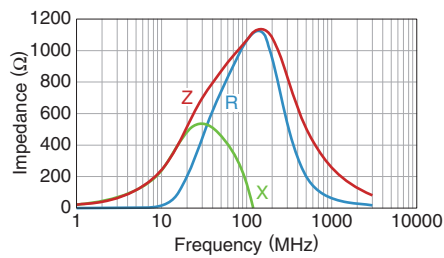

KPZ1608-HR type

SHAPE & DIMENSIONS

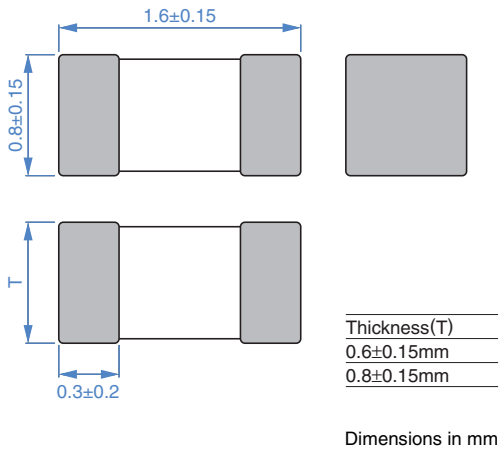

PACKAGING STYLE

REEL DIMENSIONS

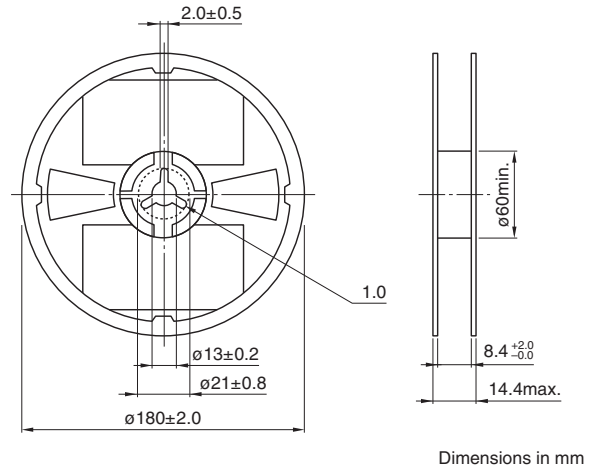

RECOMMENDED LAND PATTERN

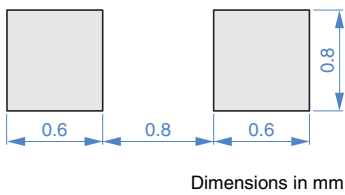

TAPE DIMENSIONS

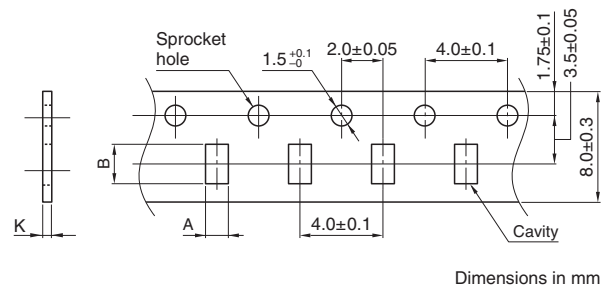

RECOMMENDED REFLOW PROFILE

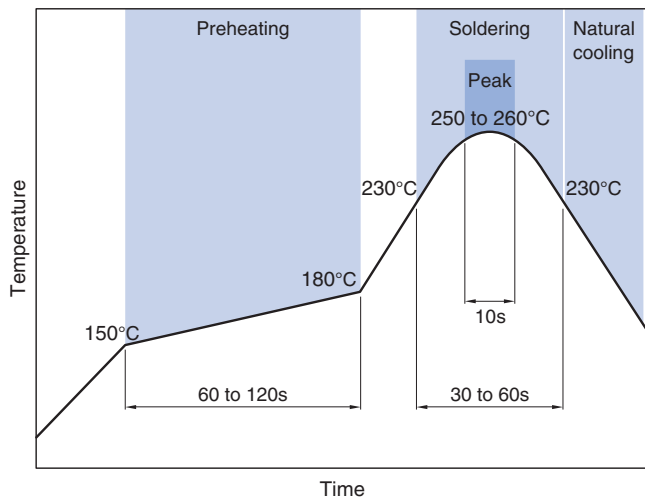

Type	A	B	K
KPZ1608-HR	1.1±0.2	1.9±0.2	1.1max.

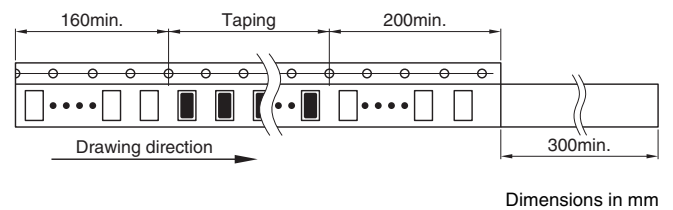

PACKAGE QUANTITY

Package quantity	4,000 pcs/reel
------------------	----------------

TEMPERATURE RANGE, INDIVIDUAL WEIGHT

Type	Operating temperature range	Storage temperature range*	Individual weight
t=0.6mm (DH5)	-55 to +150 °C	-55 to +150 °C	3 mg
t=0.8mm (D25)	-55 to +150 °C	-55 to +150 °C	4 mg

* The storage temperature range is for after the assembly.

REMINDERS FOR USING THESE PRODUCTS

Before using these products, be sure to request the delivery specifications.

SAFETY REMINDERS

Please pay sufficient attention to the warnings for safe designing when using this products.

REMINDERS

- The storage period is within 12 months. Be sure to follow the storage conditions (temperature: 5 to 40°C, humidity: 10 to 75% RH or less).
If the storage period elapses, the soldering of the terminal electrodes may deteriorate.
- Do not use or store in locations where there are conditions such as gas corrosion (salt, acid, alkali, etc.).
- Before soldering, be sure to preheat components.
The preheating temperature should be set so that the temperature difference between the solder temperature and chip temperature does not exceed 150°C.
- Soldering corrections after mounting should be within the range of the conditions determined in the specifications.
If overheated, a short circuit, performance deterioration, or lifespan shortening may occur.
- When embedding a printed circuit board where a chip is mounted to a set, be sure that residual stress is not given to the chip due to the overall distortion of the printed circuit board and partial distortion such as at screw tightening portions.
- Self heating (temperature increase) occurs when the power is turned ON, so the tolerance should be sufficient for the set thermal design.
- Carefully lay out the coil for the circuit board design of the non-magnetic shield type.
A malfunction may occur due to magnetic interference.
- Use a wrist band to discharge static electricity in your body through the grounding wire.
- Do not expose the products to magnets or magnetic fields.
- Do not use for a purpose outside of the contents regulated in the delivery specifications.
- The products listed on this catalog are intended for use in general electronic equipment (AV equipment, telecommunications equipment, home appliances, amusement equipment, computer equipment, personal equipment, office equipment, measurement equipment, industrial robots) under a normal operation and use condition.
The products are not designed or warranted to meet the requirements of the applications listed below, whose performance and/or quality require a more stringent level of safety or reliability, or whose failure, malfunction or trouble could cause serious damage to society, person or property.
If you intend to use the products in the applications listed below or if you have special requirements exceeding the range or conditions set forth in the each catalog, please contact us.

- (1) Aerospace/aviation equipment
- (2) Transportation equipment (electric trains, ships, etc.)
- (3) Medical equipment
- (4) Power-generation control equipment
- (5) Atomic energy-related equipment
- (6) Seabed equipment
- (7) Transportation control equipment

- (8) Public information-processing equipment
- (9) Military equipment
- (10) Electric heating apparatus, burning equipment
- (11) Disaster prevention/crime prevention equipment
- (12) Safety equipment
- (13) Other applications that are not considered general-purpose applications

When designing your equipment even for general-purpose applications, you are kindly requested to take into consideration securing protection circuit/device or providing backup circuits in your equipment.