

LED Driver ICs for High Power LEDs

ILD6150

60 V / 1.5 A High Efficiency Step-Down LED Driver IC

Data Sheet

Revision 3.2, 2014-07-09

Edition 2014-07-09

**Published by
Infineon Technologies AG
81726 Munich, Germany**

**© 2014 Infineon Technologies AG
All Rights Reserved.**

Legal Disclaimer

The information given in this document shall in no event be regarded as a guarantee of conditions or characteristics. With respect to any examples or hints given herein, any typical values stated herein and/or any information regarding the application of the device, Infineon Technologies hereby disclaims any and all warranties and liabilities of any kind, including without limitation, warranties of non-infringement of intellectual property rights of any third party.

Information

For further information on technology, delivery terms and conditions and prices, please contact the nearest Infineon Technologies Office (www.infineon.com).

Warnings

Due to technical requirements, components may contain dangerous substances. For information on the types in question, please contact the nearest Infineon Technologies Office.

Infineon Technologies components may be used in life-support devices or systems only with the express written approval of Infineon Technologies, if a failure of such components can reasonably be expected to cause the failure of that life-support device or system or to affect the safety or effectiveness of that device or system. Life support devices or systems are intended to be implanted in the human body or to support and/or maintain and sustain and/or protect human life. If they fail, it is reasonable to assume that the health of the user or other persons may be endangered.

Revision History

Page or Item	Subjects (major changes since previous revision)
Revision 3.2, 2014-07-09	
Table 2	Footnote 1 updated respective ESD protection on pin VS
Revision 3.1, 2014-06-05	
Table 1	Pin 1 function changed to bias control input voltage
Table 2	Upper spec limit of bias control voltage changed to V_S
Table 4	Operating conditions for bias control voltage V_B added
Figure 6	Pin 1 to V_S connection updated
Revision 3.0, 2013-10-10	
All	Initial release of final data sheet

Trademarks of Infineon Technologies AG

AURIX™, C166™, CanPAK™, CIPOS™, CIPURSE™, EconoPACK™, CoolMOS™, CoolSET™, CORECONTROL™, CROSSAVE™, DAVE™, DI-POL™, EasyPIM™, EconoBRIDGE™, EconoDUAL™, EconoPIM™, EconoPACK™, EiceDRIVER™, eupec™, FCOS™, HITFET™, HybridPACK™, I²RF™, ISOFACE™, IsoPACK™, MIPAK™, ModSTACK™, my-d™, NovalithIC™, OptiMOS™, ORIGA™, POWERCODE™, PRIMARION™, PrimePACK™, PrimeSTACK™, PRO-SIL™, PROFET™, RASIC™, ReverSave™, SatRIC™, SIEGET™, SINDRION™, SIPMOS™, SmartLEWIS™, SOLID FLASH™, TEMPFET™, thinQ!™, TRENCHSTOP™, TriCore™.

Other Trademarks

Advance Design System™ (ADS) of Agilent Technologies, AMBA™, ARM™, MULTI-ICE™, KEIL™, PRIMECELL™, REALVIEW™, THUMB™, μVision™ of ARM Limited, UK. AUTOSAR™ is licensed by AUTOSAR development partnership. Bluetooth™ of Bluetooth SIG Inc. CAT-iq™ of DECT Forum. COLOSSUS™, FirstGPS™ of Trimble Navigation Ltd. EMV™ of EMVCo, LLC (Visa Holdings Inc.). EPCOS™ of Epcos AG. FLEXGO™ of Microsoft Corporation. FlexRay™ is licensed by FlexRay Consortium. HYPERTERMINAL™ of Hilgraeve Incorporated. IEC™ of Commission Electrotechnique Internationale. IrDA™ of Infrared Data Association Corporation. ISO™ of INTERNATIONAL ORGANIZATION FOR STANDARDIZATION. MATLAB™ of MathWorks, Inc. MAXIM™ of Maxim Integrated Products, Inc. MICROTEC™, NUCLEUS™ of Mentor Graphics Corporation. MIPI™ of MIPI Alliance, Inc. MIPS™ of MIPS Technologies, Inc., USA. muRata™ of MURATA MANUFACTURING CO., MICROWAVE OFFICE™ (MWO) of Applied Wave Research Inc., OmniVision™ of OmniVision Technologies, Inc. Openwave™ Openwave Systems Inc. RED HAT™ Red Hat, Inc. RFMD™ RF Micro Devices, Inc. SIRIUS™ of Sirius Satellite Radio Inc. SOLARIS™ of Sun Microsystems, Inc. SPANSION™ of Spansion LLC Ltd. Symbian™ of Symbian Software Limited. TAIYO YUDEN™ of Taiyo Yuden Co. TEAKLITE™ of CEVA, Inc. TEKTRONIX™ of Tektronix Inc. TOKO™ of TOKO KABUSHIKI KAISHA TA. UNIX™ of X/Open Company Limited. VERILOG™, PALLADIUM™ of Cadence Design Systems, Inc. VLYNQ™ of Texas Instruments Incorporated. VXWORKS™, WIND RIVER™ of WIND RIVER SYSTEMS, INC. ZETEX™ of Diodes Zetex Limited.

Last Trademarks Update 2011-11-11

Table of Contents

	Table of Contents	4
	List of Figures	5
	List of Tables	6
1	Features	7
2	Product Brief	8
3	Maximum Ratings	10
4	Thermal Characteristics	11
5	Electrical Characteristics	12
5.1	DC Characteristics	12
5.2	Switching Characteristics	14
5.3	Digital Control Signals	15
5.4	Switching Parameters	16
6	Application Circuit	21
6.1	Setting the average LED current	21
6.2	Inductor Selection Guideline	22
7	Package Information	24

List of Figures

Figure 1	Block Diagram	8
Figure 2	Total Power Dissipation	11
Figure 3	Typical Output Current Duty Cycle of Over-Temperature Protection vs. T_J and R_{Tadj}	13
Figure 4	PWM Input	15
Figure 5	Typical Integrated PWM Duty Cycle vs. PWM Control Voltage	16
Figure 6	Application Circuit	21
Figure 7	Minimum Inductance for 0.35 A Average LED Current	22
Figure 8	Minimum Inductance for 0.7 A Average LED Current	22
Figure 9	Minimum Inductance for 1.5 A Average LED Current	23
Figure 10	Package outline PG-DSO-8-27 (dimensions in mm)	24
Figure 11	Recommended PCB Footprint for Reflow Soldering (dimensions in mm)	24
Figure 12	Tape Loading (dimensions in mm)	24

List of Tables

Table 1	Pin Definition and Function	9
Table 2	Maximum Ratings	10
Table 3	Maximum Thermal Resistance	11
Table 4	DC Characteristics	12
Table 5	Switching Characteristics	14
Table 6	Digital Control Parameter at Pin PWM	15
Table 7	Analog Control Parameter at Pin PWM	16

60 V / 1.5 A High Efficiency Step-Down LED Driver IC

1 Features

- Wide input voltage range from 4.5 V to 60 V
- Capable to provide up to 1.5 A average output current
- Up to 1 MHz switching frequency
- Soft-start capability
- Analog and PWM dimming possible
- Integrated PWM generator for analog dimming input
- Typical 3% output current accuracy
- Very low LED current drift over temperature
- Adjustable over-temperature protection
- Undervoltage lockout
- Over-current protection
- Thermally optimized package: PG-DSO-8-27

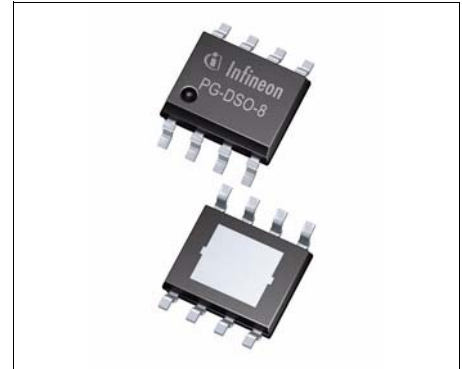

Applications

- LED driver for general lighting
- Retail, office and residential downlights
- Street and tunnel lighting
- LED ballasts

Product Name	Package	Marking
ILD6150	PG-DSO-8-27	ILD6150

2 Product Brief

The ILD6150 is a hysteretic buck LED driver IC for driving high power LEDs in general lighting applications with average currents up to 1.5 A.

The ILD6150 is suitable for LED applications with a wide range of supply voltages from 4.5 V to 60 V. A multifunctional PWM input signal allows dimming of the LEDs with an analog DC voltage or an external PWM signal. To minimize colorshifts of the LEDs an analog PWM voltage is converted to an internal 1.6 kHz PWM signal modulating the LED current.

The ILD6150 incorporates an undervoltage lock-out that will shut down the IC when the minimum supply voltage threshold is exceeded. The over-current protection turns off the output stage once the output current is above the current threshold. An integrated over-temperature protection circuit will start to reduce the LED current by internal PWM modulation once the adjustable junction temperature threshold of the IC is exceeded. Realizing a thermal coupling between LED driver IC and LEDs this feature eliminates the need of external temperature sensors as NTCs or PTCs.

Thanks to the hysteretic concept the current control is extremely fast and always stable. A maximum contrast ratio of 3000:1 can be achieved depending of the dimensioning of the external components. The efficiency of the LED driver IC is remarkable high, reaching up to 98% of efficiency over a wide range. The output current accuracy from device to device and under all load conditions and over temperature is limited to a minimum, making ILD6150 the perfect fit for LED ballasts.

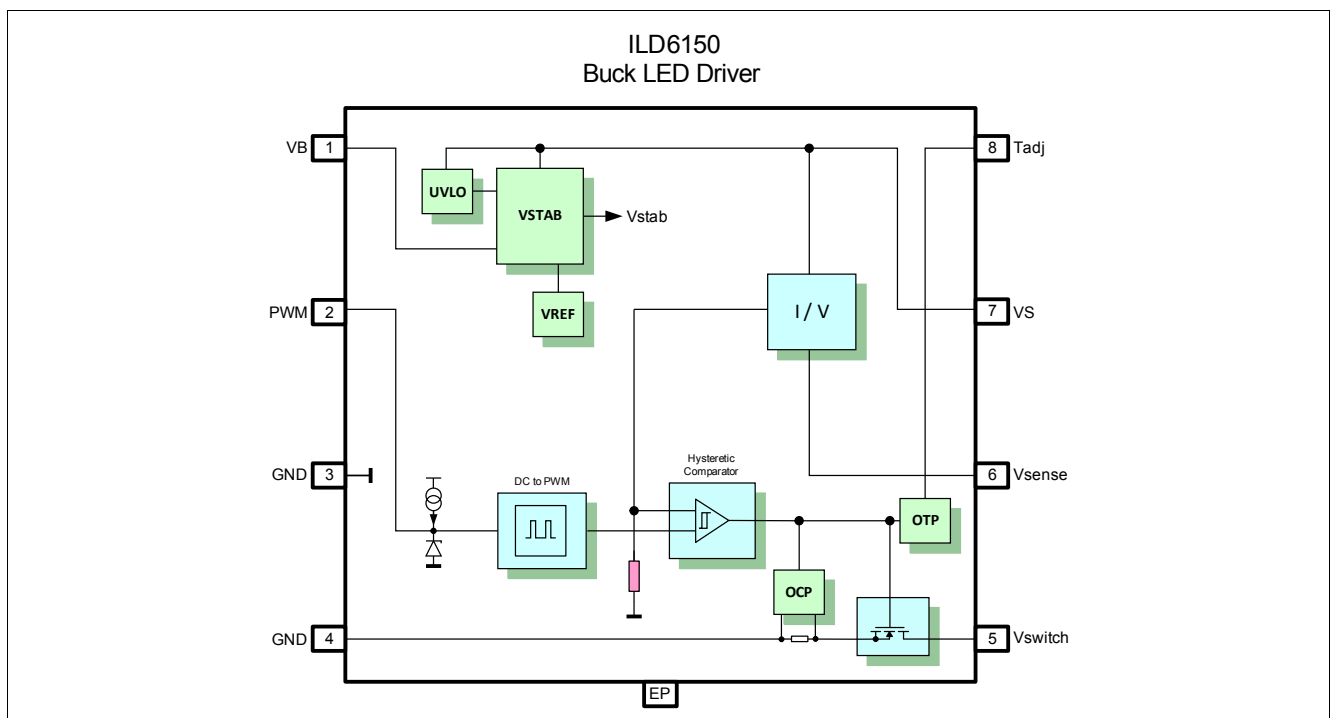

Figure 1 Block Diagram

Pin Definition

Table 1 Pin Definition and Function

Pin No.	Name	Pin Type	Buffer Type	Function
1	VB	Input	–	Bias control input voltage, recommended to connect to pin VS
2	PWM	Input	–	Dimming signal: • Analog dimming • PWM dimming
3	GND	GND	–	IC ground
4	GND	GND	–	IC ground
5	Vswitch	Output	–	Power switch output
6	Vsense	Input	–	LED current sense input
7	VS	Input	–	Supply voltage
8	Tadj	Output	–	Over-temperature adjustment
EP	Exposed Pad	GND	–	IC ground and heat spreader

3 Maximum Ratings

Table 2 Maximum Ratings

Parameter	Symbol	Values			Unit	Note / Test Condition
		Min.	Typ.	Max.		
Supply voltage	V_S	-0.3	–	60	V	–
Bias control voltage	V_B	-0.3	–	V_S	V	–
PWM voltage	V_{PWM}	-0.3	–	5.5	V	–
Tadj voltage	V_{Tadj}	-0.3	–	3.5	V	–
Sense voltage	V_{sense}	$V_S - 0.3$	–	V_S	V	–
Switch voltage	V_{switch}	-0.3	–	60	V	–
Average switch output current	I_{out}	–	–	1.5	A	–
Total power dissipation, $T_S \leq 116^\circ\text{C}$	P_{tot}	–	–	2	W	–
Junction temperature	T_J	-40	–	150	$^\circ\text{C}$	–
Storage temperature range	T_{STG}	-65	–	150	$^\circ\text{C}$	–
ESD capability at all pins ¹⁾	$V_{ESD\ HBM}$	–	–	2	kV	HBM acc. to JESD22 - A114

1) Two different classes of ESD protection elements are implemented within ILD6150:

1. ESD protection at pin VS will be triggered if the voltage at pin VS rises by more than 5 V with a slew rate of more than 5 V/ μs . This condition is met during an ESD event, but might also occur if the LED driver gets hotplugged into a power supply and the VS blocking capacitor has a too small capacitance. ESD protection will remain triggered as long as the slewrate condition is met. If the ESD protection gets triggered while VS is supplied the IC might be damaged.
2. ESD protection at all other pins is triggered once the connected voltage signal exceeds a threshold higher than the maximum voltage rating specified for each pin. No preventions regarding slew rate control need to be taken for these pins.

Attention: Stresses above the max. values listed here may cause permanent damage to the device. Exposure to absolute maximum rating conditions for extended periods may affect device reliability. Maximum ratings are absolute ratings; exceeding only one of these values may cause irreversible damage to the integrated circuit.

4 Thermal Characteristics

Table 3 Maximum Thermal Resistance

Parameter	Symbol	Values			Unit	Note / Test Condition
		Min.	Typ.	Max.		
Junction - soldering point ¹⁾	R_{thJS}	–	17	–	K/W	–

1) For calculation of R_{thJA} please refer to application note AN077 (Thermal Resistance Calculation)

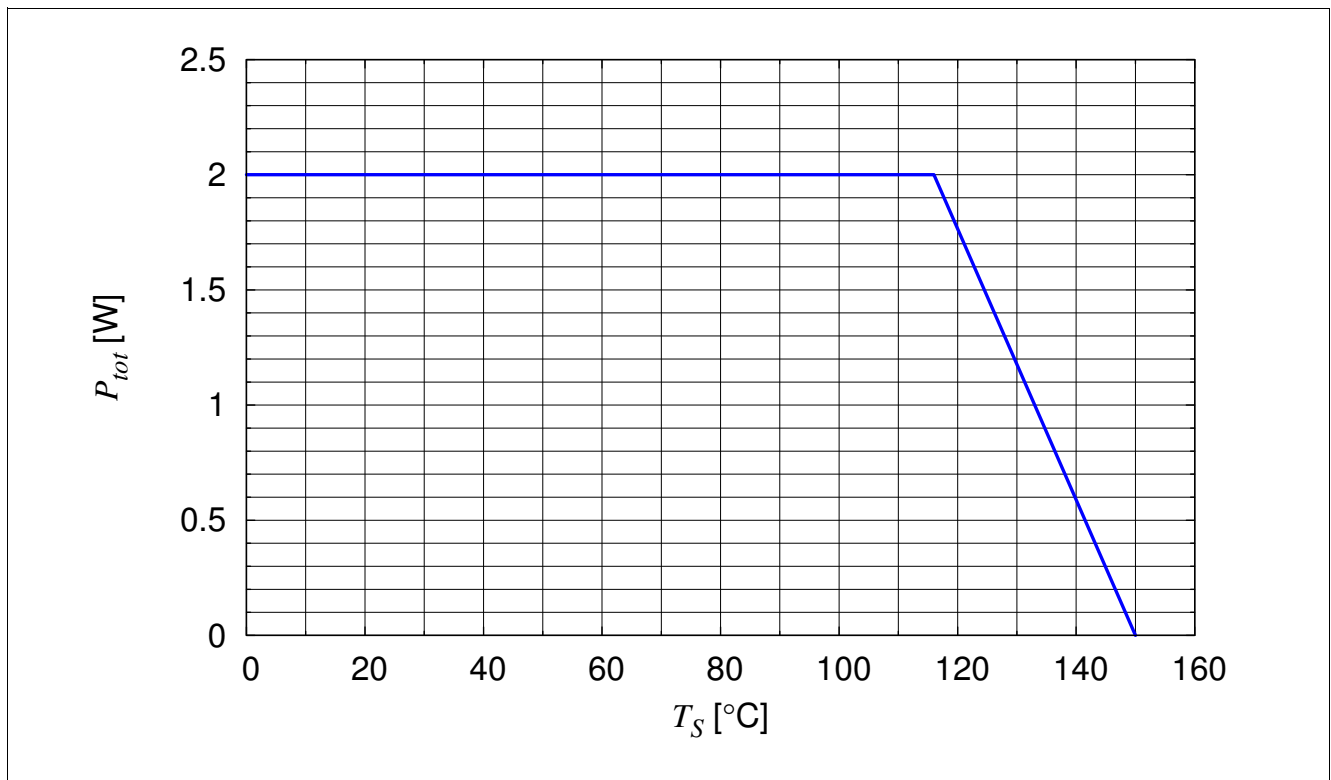

Figure 2 Total Power Dissipation

The major part of the IC power dissipation is caused by the switch resistance in conductive state. Therefore [Equation \(1\)](#) is a first estimation to calculate the total power dissipation of the IC

$$P_{tot} = R_{ON} \cdot I_{out}^2 \cdot D + I_S \cdot V_S \quad (1)$$

D : Duty cycle of the output switch

For a more precise analysis measure the soldering point temperature T_S of ILD6150 at GND pin and use [Figure 2](#) as a reference.

5 Electrical Characteristics

5.1 DC Characteristics

All parameters at $T_A = 25\text{ }^\circ\text{C}$, unless otherwise specified.

Table 4 DC Characteristics

Parameter	Symbol	Values			Unit	Note / Test Condition
		Min.	Typ.	Max.		
Operating supply voltage	V_S	4.5	–	60	V	–
Operating bias control voltage	V_B	4.5	–	V_S	V	recommended to connect to V_S
Under Voltage Lock Out	$V_{S,UV,off}$	4.05	4.25	4.45	V	IC deactivated ¹⁾
	$V_{S,UV,on}$	4.15	4.35	4.50	V	IC operative
Supply current consumption open load $V_S = V_{sense}$, $I_{LED} = 0\text{ mA}$	$I_{S,OL,4.5V}$	1.55	2.1	2.65	mA	$V_S = 4.5\text{ V}$
	$I_{S,OL,12V}$	1.60	2.2	2.70	mA	$V_S = 12\text{ V}$
	$I_{S,OL,60V}$	1.60	2.24	2.80	mA	$V_S = 60\text{ V}$
Supply voltage reset time	$t_{S,reset}$	105	160	210	μs	Reset time after V_S power up ²⁾
Current of V_{sense} input	I_{sense}	12	17	22	μA	At any LED current
Current of V_B input	$I_{B,60V}$	35	55	70	μA	$V_B = 60\text{ V}$
Output over current protection threshold	$I_{out, OCP}$	2.2	2.5	2.9	A	
Output over current protection delay time	$t_{delay, OCP}$	160	220	300	ns	turn off delay
Output over current protection time out	$t_{timeout, OCP}$	30	57	–	μs	turn off duration ³⁾
Over-temperature protection threshold range (typical), 10 % reduction	$T_{OTP, range}$	75	–	145	$^\circ\text{C}$	$R_{Tadj} = 35\text{ k}\Omega \dots 0\text{ }\Omega$ ⁴⁾
Over-temperature protection threshold open, 10 % reduction	$T_{OTP, open}$	–	115	–	$^\circ\text{C}$	$R_{Tadj} \geq 150\text{ k}\Omega$
Over-temperature protection threshold short, 10 % reduction	$T_{OTP, short}$	–	145	–	$^\circ\text{C}$	$R_{Tadj} = 0\text{ }\Omega$
Over-temperature protection, turn off	$T_{OTP, off}$	–	160	–	$^\circ\text{C}$	
Tadj pin current source to GND	$I_{Tadj, short}$	-75	-60	-45	μA	$R_{Tadj} = 0\text{ }\Omega$ ⁵⁾

- 1) IC gets deactivated once the supply voltage drops below $V_{S,UV,off}$ and gets operative once supply voltage rises above $V_{S,UV,on}$.
- 2) Reset timer starts after supply voltage exceeds the lower limit of the supply voltage. Output stage gets enabled once reset timer expires.
- 3) Once the over current protection threshold has been exceeded the output switch gets disabled. It is enabled again once the time out expired.
- 4) $T_{OTP, range}$ specifies the typical temperature tuning range achievable at a 10 % reduction of LED current using resistors with 1 % accuracy. Temperatures specified refer to junction temperature on chip. Accuracy of the temperature sensor is typical $\pm 5\text{ K}$. Any resistor value $R_{Tadj} \geq 0\text{ }\Omega$ can be selected but it might not influence OTP temperature if out of the ranges specified.
- 5) Definition of current reference: Currents flowing out of the IC have a negative magnitude.

ILD6150 has an integrated over-temperature protection based upon the junction temperature on chip. The threshold of the over-temperature protection circuit is tunable by resistor R_{Tadj} connected from pin Tadj to GND.

R_{Tadj} resistor values within 0 to 35 k Ω define the over-temperature protection behavior as shown in **Figure 3**. R_{Tadj} values ≥ 150 k Ω set the OTP threshold to $T_{OTP,open}$. The over-temperature protection is based upon modulation of the LED current with an internal PWM generator. Once the junction temperature exceeds the OTP threshold the PWM duty cycle as well as the average LED current will get reduced. Once junction temperature reaches $T_{OTP,off}$ the PWM duty cycle and LED current will be reduced to zero.

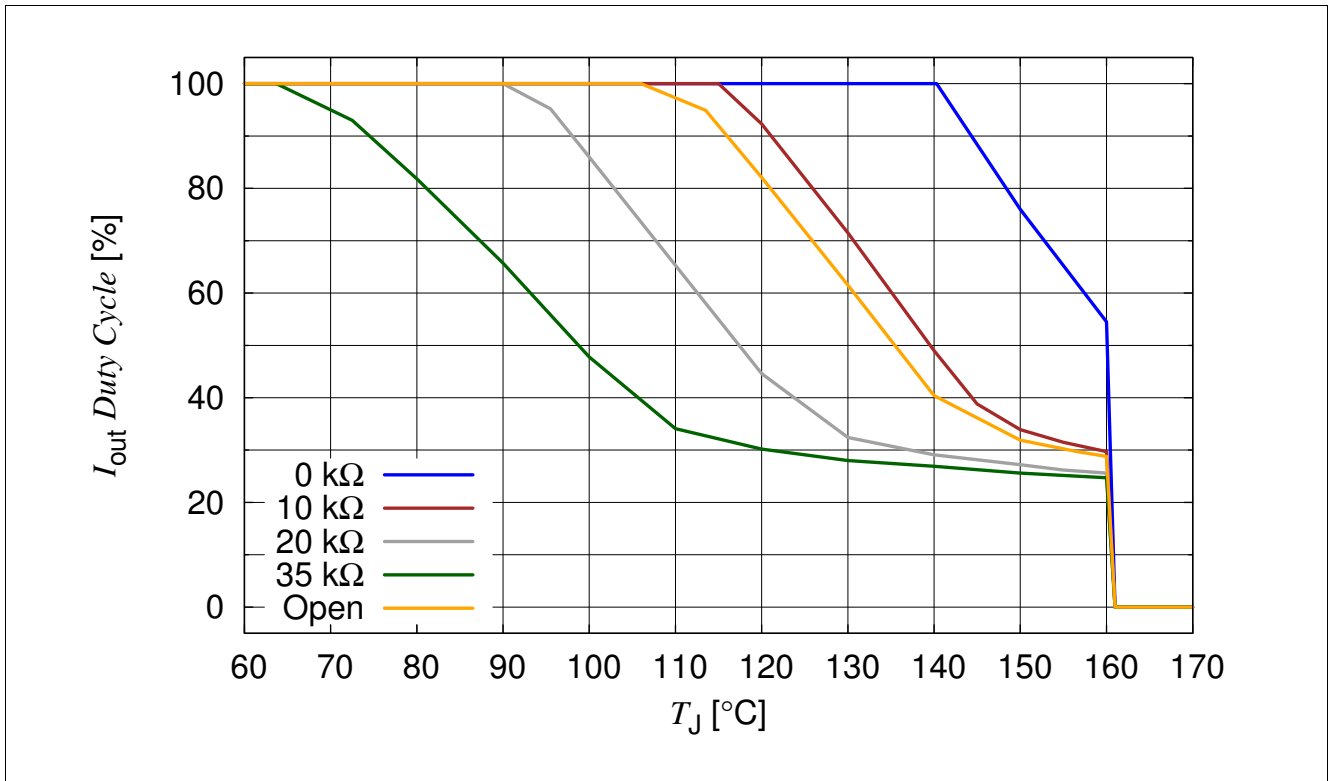

Figure 3 Typical Output Current Duty Cycle of Over-Temperature Protection vs. T_J and R_{Tadj}

5.2 Switching Characteristics

All parameters at $T_A = 25\text{ °C}$, unless otherwise specified.

Table 5 Switching Characteristics

Parameter	Symbol	Values			Unit	Note / Test Condition
		Min.	Typ.	Max.		
Switching frequency	f_{switch}	–	–	1	MHz	
Mean current sense threshold voltage	V_{sense}	–	152	–	mV	$f_{\text{switch}} = 100\text{ kHz}$
Sense threshold hysteresis	V_{sensehys}	–	± 22	–	%	peak to average $V_S = 12\text{ V}$ $f_{\text{switch}} = 100\text{ kHz}$
Output current variation over supply voltage	$I_{\text{out, } V_S}$	–	± 3	–	%	
Output current variation over temperature	$I_{\text{out, } T_S}$	–	± 4	–	%	for temperatures below OTP threshold
Output current variation over load	$I_{\text{out, load}}$	–	± 3	–	%	fixed V_S
Switch on resistance	$R_{\text{ON, } 25\text{ °C}}$	0.2	0.23	0.26	Ω	$I_{\text{SW}} = 1\text{ A}, T_J = 25\text{ °C}$
	$R_{\text{ON, } 125\text{ °C}}$	0.29	0.34	0.39	Ω	$I_{\text{SW}} = 1\text{ A}, T_J = 125\text{ °C}$

5.3 Digital Control Signals

All parameters at $T_A = 25\text{ }^\circ\text{C}$, unless otherwise specified.

Dimming of the LED current can be achieved by an analog or digital input voltage connected to pin PWM. A digital input signal will modulate the LED current according to [Table 6](#).

Table 6 Digital Control Parameter at Pin PWM¹⁾

Parameter	Symbol	Values			Unit	Note / Test Condition
		Min.	Typ.	Max.		
PWM voltage logic high level	$V_{\text{PWM, high}}$	2.6	–	5.5	V	output stage enabled
PWM voltage logic low level	$V_{\text{PWM, low}}$	-0.3	–	0.5	V	output stage disabled
PWM output current	$I_{\text{CC, PWM}}$	-23	-18	-12	μA	$V_{\text{PWM}} = 0\text{ V}$
PWM delay time	$t_{\text{d, PWM, on}}$	–	0.8	–	μs	$V_{\text{PWM}} =$ rising to 2.5 V $V_{\text{switch}} =$ falling to 1 V
	$t_{\text{d, PWM, off}}$	–	0.6	–	μs	$V_{\text{PWM}} =$ falling to 0.5 V $V_{\text{switch}} =$ rising to 1 V
PWM signal frequency	$f_{\text{PWM, ext}}$	–	–	25	kHz	

1) PWM pin has an internal pull-up circuit to high level if not connected externally on PCB

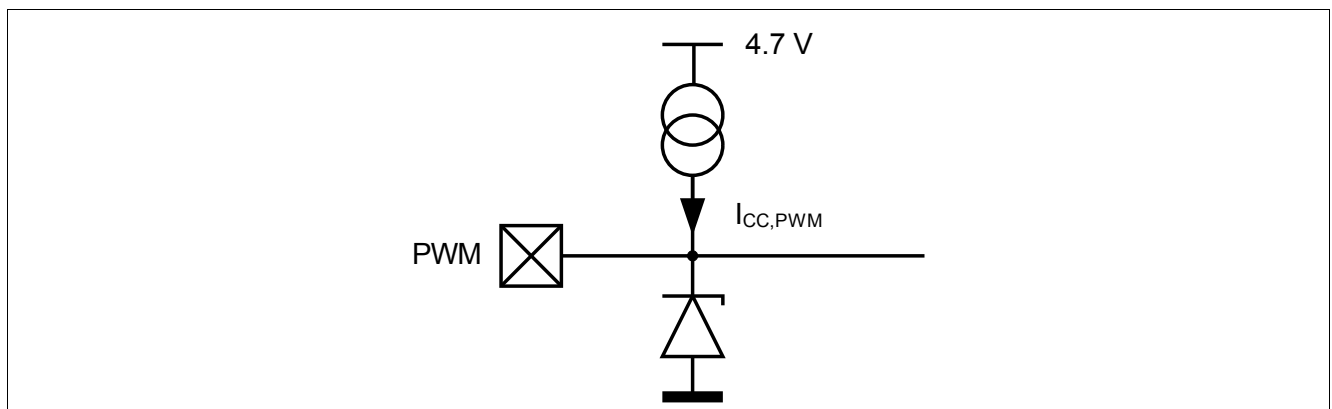

Figure 4 PWM Input

An analog PWM input voltage activates modulation of the LED current by the integrated PWM generator running at frequency $f_{\text{PWM, int}}$. Its duty cycle corresponds to analog PWM control voltage as shown in [Table 7](#) and [Figure 5](#).

Table 7 Analog Control Parameter at Pin PWM

Parameter	Symbol	Values			Unit	Note / Test Condition
		Min.	Typ.	Max.		
PWM input voltage for 0% duty cycle	$V_{PWM, 0\%}$	–	0.61	–	V	
PWM input voltage for 50% duty cycle	$V_{PWM, 50\%}$	–	1.52	–	V	
PWM input voltage for 100% duty cycle	$V_{PWM, 100\%}$	–	2.43	–	V	
Sensitivity of PWM duty cycle vs. PWM input voltage	D.C./ V_{PWM}	–	55	–	%/V	
Integrated PWM generator frequency	$f_{PWM, int}$	1.2	1.6	2.1	kHz	

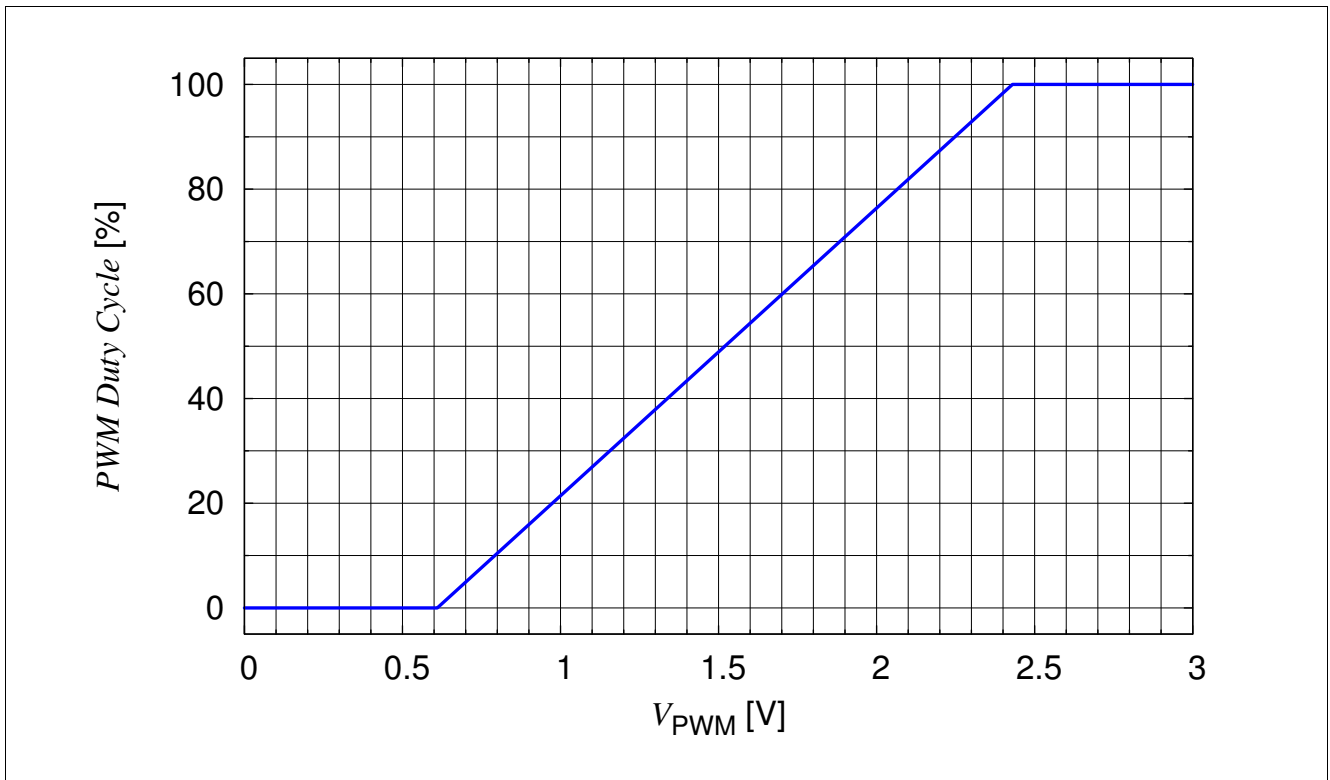
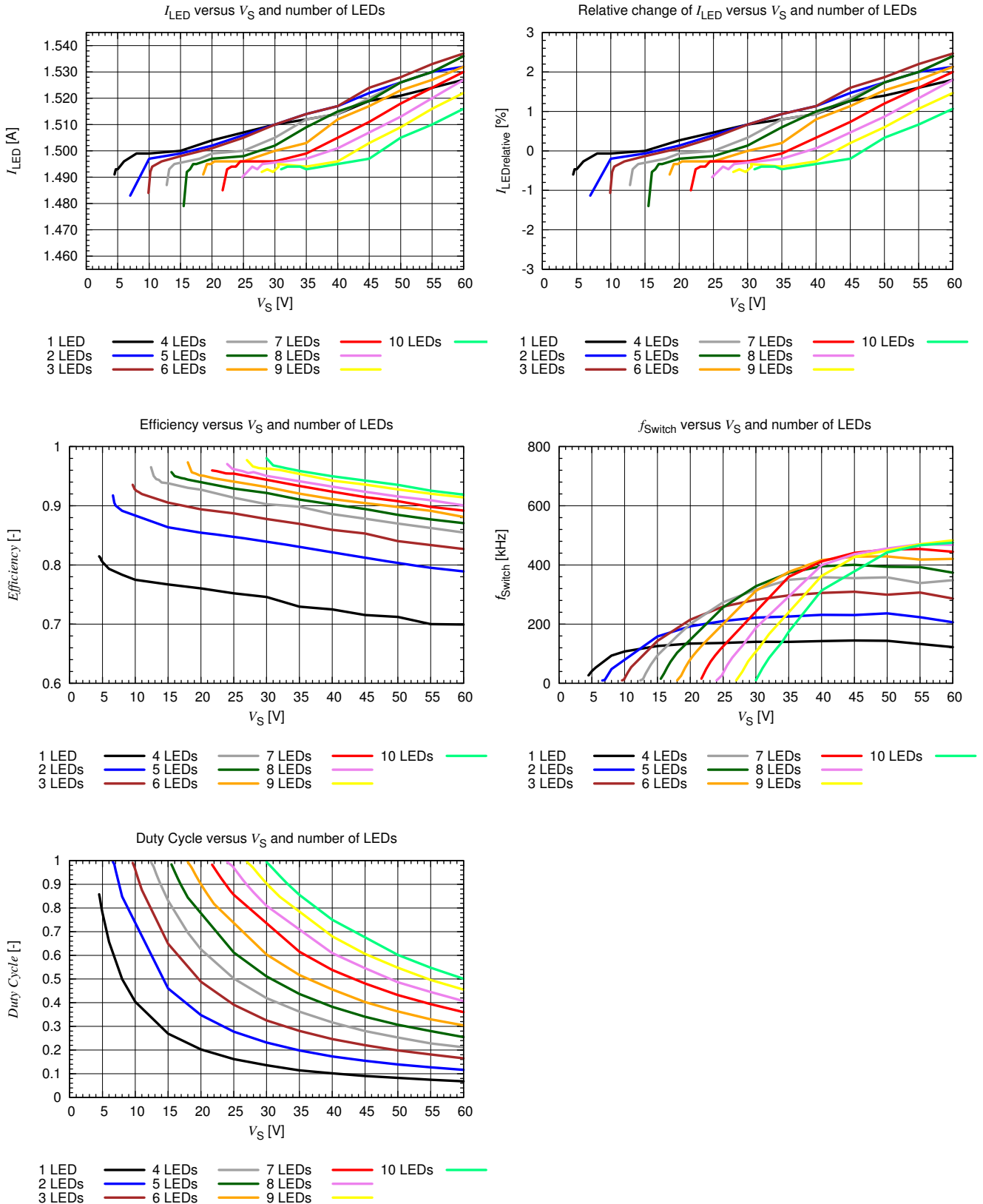

Figure 5 Typical Integrated PWM Duty Cycle vs. PWM Control Voltage

5.4 Switching Parameters

For all shown switching parameters ILD6150 has been measured on evaluation board ILD6150 at $T_A = 25^\circ\text{C}$. Used LEDs have a typical V_{fLED} of 3 V. Efficiency figure shows total efficiency of the application board including losses of external components as inductor or Schottky diode. See the application note for further details.

Performance vs. supply voltage and number of LEDs: $R_{sense} = 100\text{ m}\Omega$, $L = 47\text{ }\mu\text{H}$, $V_{fLED} = 3\text{ V}$



Performance vs. supply voltage and number of LEDs: $R_{sense} = 213 \text{ m}\Omega$, $L = 68 \text{ }\mu\text{H}$, $V_{fLED} = 3 \text{ V}$

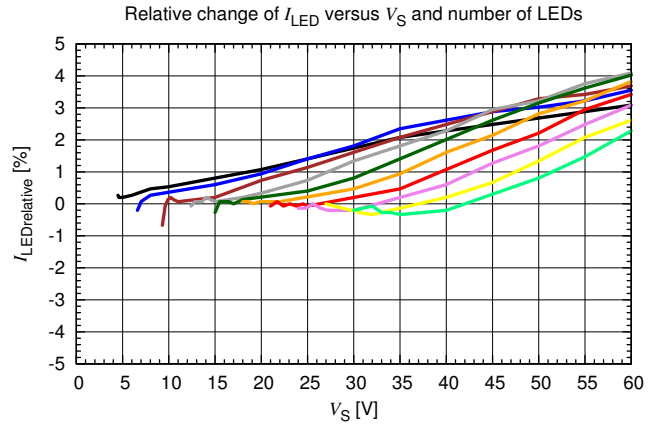
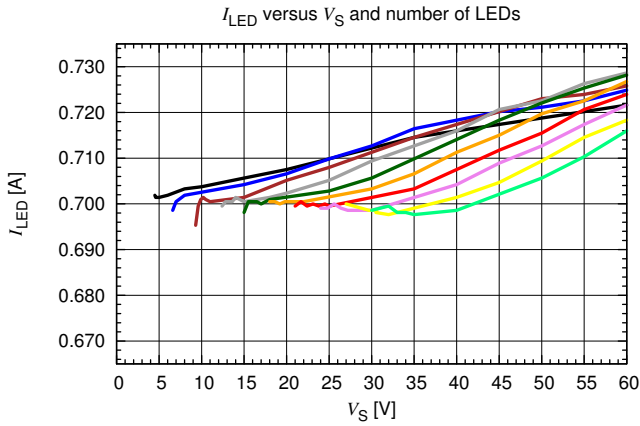

1 LED — 4 LEDs — 7 LEDs — 10 LEDs —
2 LEDs — 5 LEDs — 8 LEDs —
3 LEDs — 6 LEDs — 9 LEDs —

1 LED — 4 LEDs — 7 LEDs — 10 LEDs —
2 LEDs — 5 LEDs — 8 LEDs —
3 LEDs — 6 LEDs — 9 LEDs —

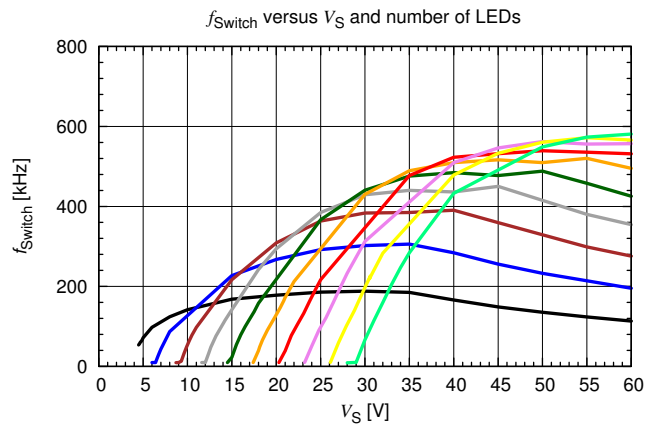
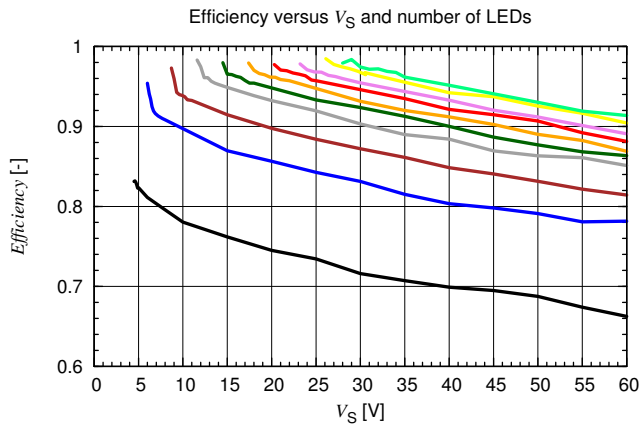

1 LED — 4 LEDs — 7 LEDs — 10 LEDs —
2 LEDs — 5 LEDs — 8 LEDs —
3 LEDs — 6 LEDs — 9 LEDs —

1 LED — 4 LEDs — 7 LEDs — 10 LEDs —
2 LEDs — 5 LEDs — 8 LEDs —
3 LEDs — 6 LEDs — 9 LEDs —

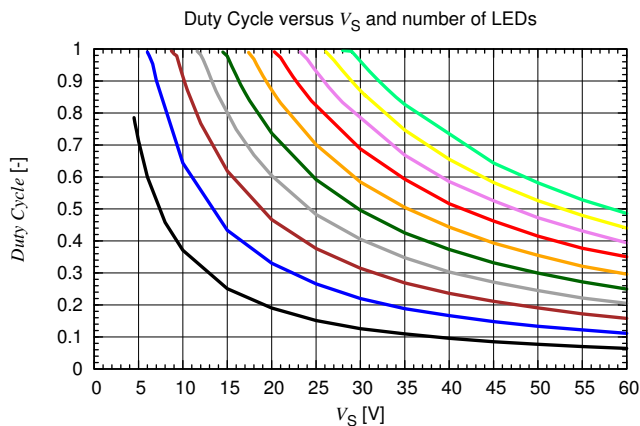

1 LED — 4 LEDs — 7 LEDs — 10 LEDs —
2 LEDs — 5 LEDs — 8 LEDs —
3 LEDs — 6 LEDs — 9 LEDs —

Performance vs. supply voltage and number of LEDs: $R_{sense} = 422 \text{ m}\Omega$, $L = 150 \text{ }\mu\text{H}$, $V_{fLED} = 3 \text{ V}$

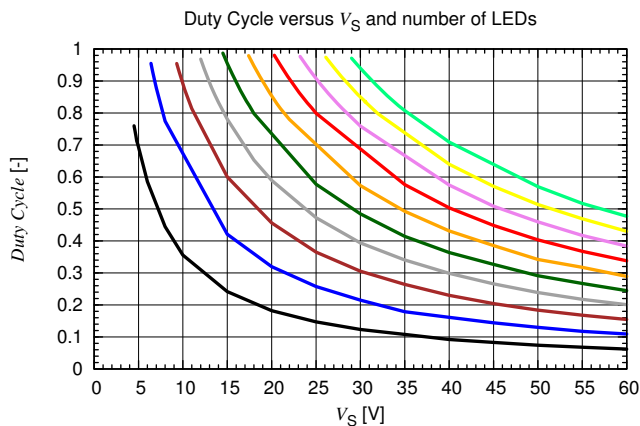
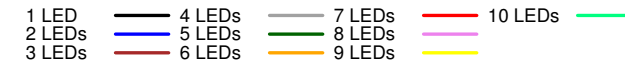
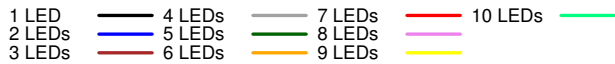
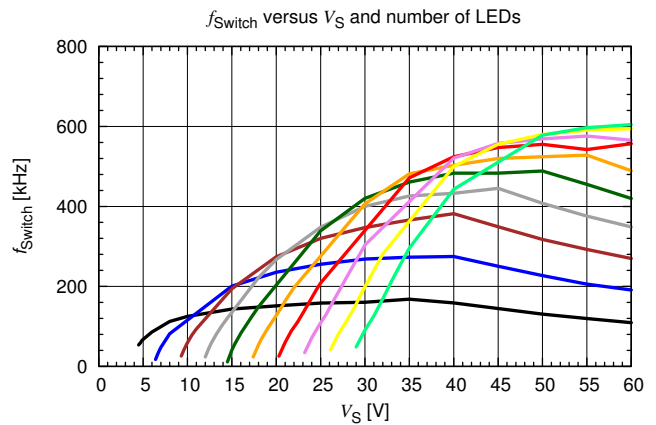
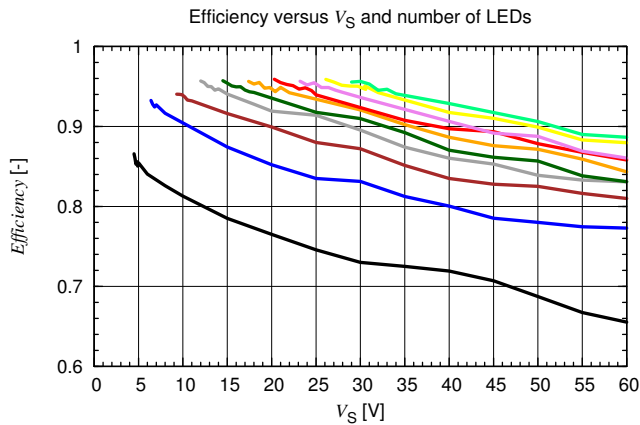
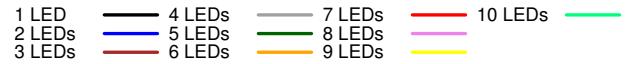
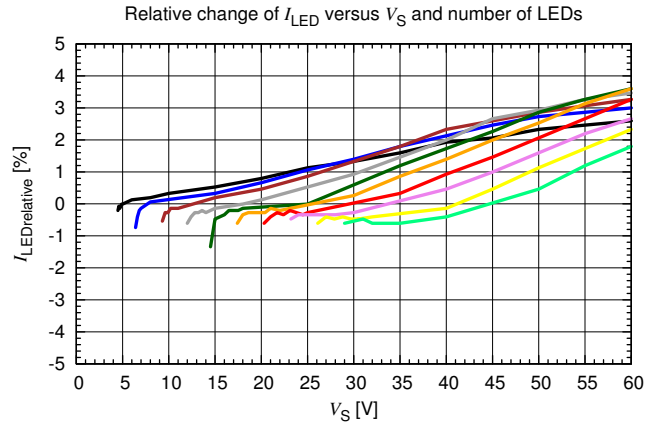
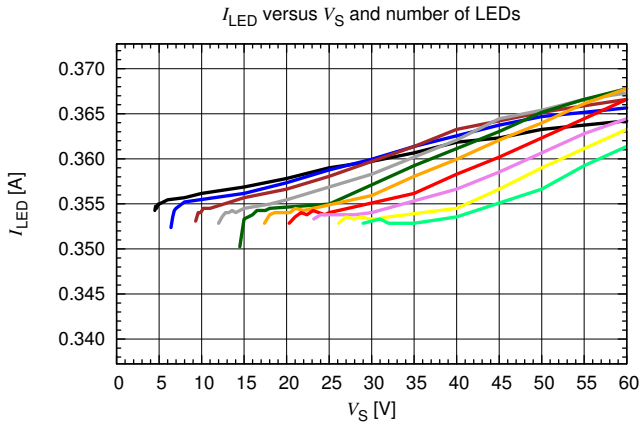

LED current vs. soldering point temperature: $R_{sense} = 213 \text{ m}\Omega$, $L = 47 \text{ }\mu\text{H}$, $V_{fLED} = 3 \text{ V}$, $R_{Tadj} = 0 \text{ }\Omega$.

Note: Soldering point temperature was measured on application PCB close to chip exposed pad. See application note AN-EVAL-ILD6150 for board details. Over-temperature protection has been adjusted to max. threshold connecting Tadj pin to GND with $R_{Tadj} = 0 \text{ }\Omega$.

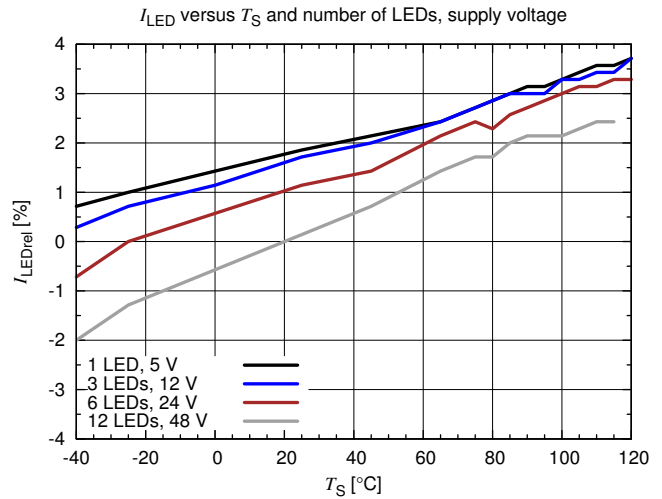
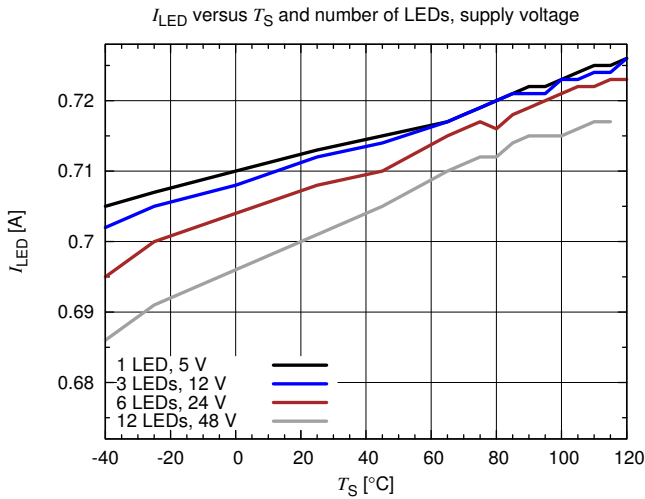

LED current vs. soldering point temperature: $R_{sense} = 100 \text{ m}\Omega$, $L = 68 \text{ }\mu\text{H}$, $V_{fLED} = 3 \text{ V}$, $R_{Tadj} = 0 \text{ }\Omega$.

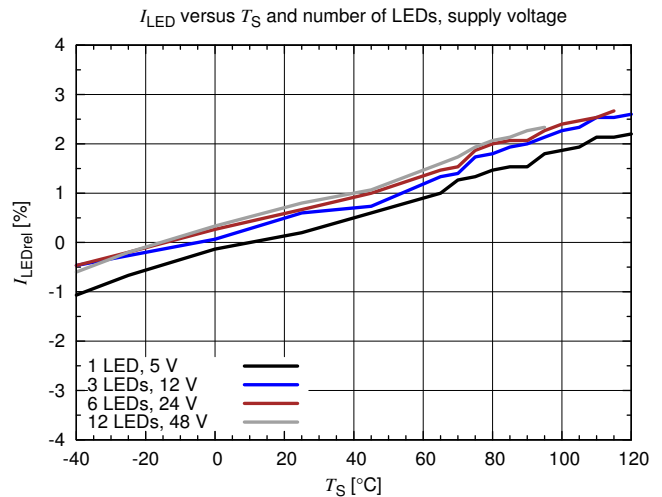
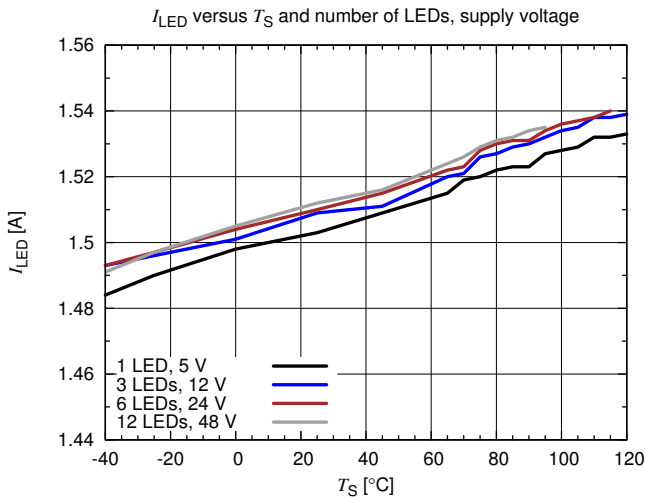

6 Application Circuit

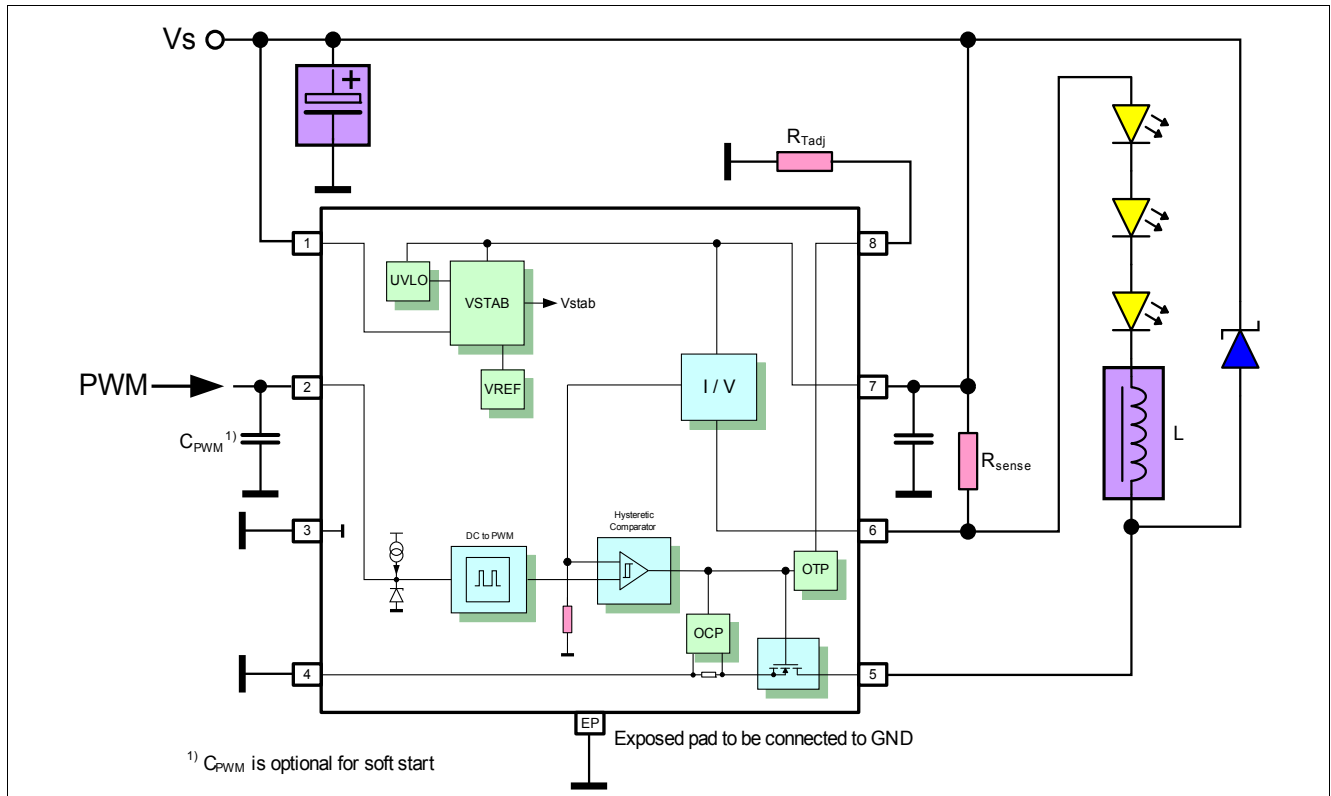

Figure 6 Application Circuit

A V_S blocking capacitor shall be placed close to pin 7 to enable a low ripple V_{sense} measurement and to avoid a false triggering of the V_S ESD protection element inside the IC. To enable the bias control of the IC it is most simple to connect pin 1 of the IC to supply voltage V_S .

6.1 Setting the average LED current

The average output current for the LEDs is set by the external sense resistor R_{sense} . To calculate the value of this resistor a first approximation can be calculated using [Equation \(2\)](#).

V_{sense} is slightly dependent on the supply voltage V_S and the number of LEDs as shown in [Chapter 5.4](#).

$$R_{sense} = \frac{V_{sense}}{I_{LED}}$$

(2)

Example calculation

$V_S = 12\text{ V}$, $47\ \mu\text{H}$, $V_{fLED} = 3\text{ V}$, 3 LEDs in series

→ $V_{sense} = 152\text{ mV}$

$I_{LED} = 1.5\text{ A}$

→ $R_{sense} = 101\text{ m}\Omega$

An easy way to achieve these resistor values is to connect standard resistors in parallel.

6.2 Inductor Selection Guideline

The inductance of the inductor L, the supply voltage V_S , the number of LEDs driven and their average LED current significantly influence the slew rate of the LED current in on and off condition of the LED driver IC output switch. Due to the hysteretic current control ILD6150 will toggle the output driver stage each time upper or lower current threshold are reached. To maintain best regulation capability of the LED driver IC it is reasonable to keep a margin to the minimum switch on and off time defined by internal propagation delay times. Disregard of this recommendation by choosing too small inductor values might result in an increased LED current ripple and loss of LED current regulation accuracy.

Minimum 350 ns on and off time are recommended as a reasonable design target for the inductor selection. Below figures provide a guideline concerning minimum inductance value versus supply voltage and number of LEDs. It is assumed that the forward voltage of each LED is within a range of 2.5 V to 3.9 V over temperature and LED production tolerances. Minimum forward voltage (e.g. occurring at high LED temperatures) needs to be considered with respect to the minimum switch on-time while maximum forward voltage (e.g. occurring at low temperatures) needs to be considered with respect to the switch off-time.

The saturation current of the chosen inductor has to be higher than the peak LED current and the rating of its continuous current needs to exceed the average LED current.

0.35 A		Number of LEDs														
V_S [V]	1	2	3	4	5	6	7	8	9	10	11	12	13	14	15	
5	15															
10	22	33														
15	47	33	47													
20	68	47	47	47	68											
25	68	68	68	47	68	68										
30	100	100	68	68	68	68	100									
35	100	100	100	100	68	68	100	100								
40	150	100	100	100	100	100	100	100	100	150						
45	150	150	150	100	100	100	100	100	100	150	150					
50	150	150	150	150	150	100	100	100	100	150	150	150				
55	150	150	150	150	150	150	150	100	100	150	150	150	150	220		
60	220	220	150	150	150	150	150	150	150	150	150	150	150	220	220	

Inductance in μH ; $2.5 \text{ V} \leq V_{\text{LED}} \leq 3.9 \text{ V}$

Figure 7 Minimum Inductance for 0.35 A Average LED Current

0.7 A		Number of LEDs														
V_S [V]	1	2	3	4	5	6	7	8	9	10	11	12	13	14	15	
5	6.8															
10	10	15														
15	22	15	22													
20	33	22	22	33	33											
25	33	33	33	33	33	47										
30	47	47	33	33	33	47	47									
35	47	47	47	47	33	47	47	47								
40	68	68	47	47	47	47	47	47	68	68						
45	68	68	68	68	47	47	47	47	68	68	68					
50	68	68	68	68	68	68	47	47	68	68	68	68				
55	100	100	68	68	68	68	68	68	68	68	68	68	100			
60	100	100	100	100	68	68	68	68	68	68	68	68	100	100	100	

Inductance in μH ; $2.5 \text{ V} \leq V_{\text{LED}} \leq 3.9 \text{ V}$

Figure 8 Minimum Inductance for 0.7 A Average LED Current

1.5 A	Number of LEDs														
V _s [V]	1	2	3	4	5	6	7	8	9	10	11	12	13	14	15
5	4.7														
10	6.8	10													
15	10	10	10												
20	15	10	10	15											
25	15	15	15	15	15	22									
30	22	22	15	15	15	22	22								
35	22	22	22	22	15	22	22	22							
40	33	33	22	22	22	22	22	22	33	33					
45	33	33	33	33	22	22	22	22	33	33	33				
50	33	33	33	33	33	33	22	22	33	33	33	33			
55	47	33	33	33	33	33	33	33	33	33	33	33	47		
60	47	47	47	33	33	33	33	33	33	33	33	33	47	47	47

Inductance in μH ; $2.5 \text{ V} \leq V_{\text{LED}} \leq 3.9 \text{ V}$

Figure 9 Minimum Inductance for 1.5 A Average LED Current

7 Package Information

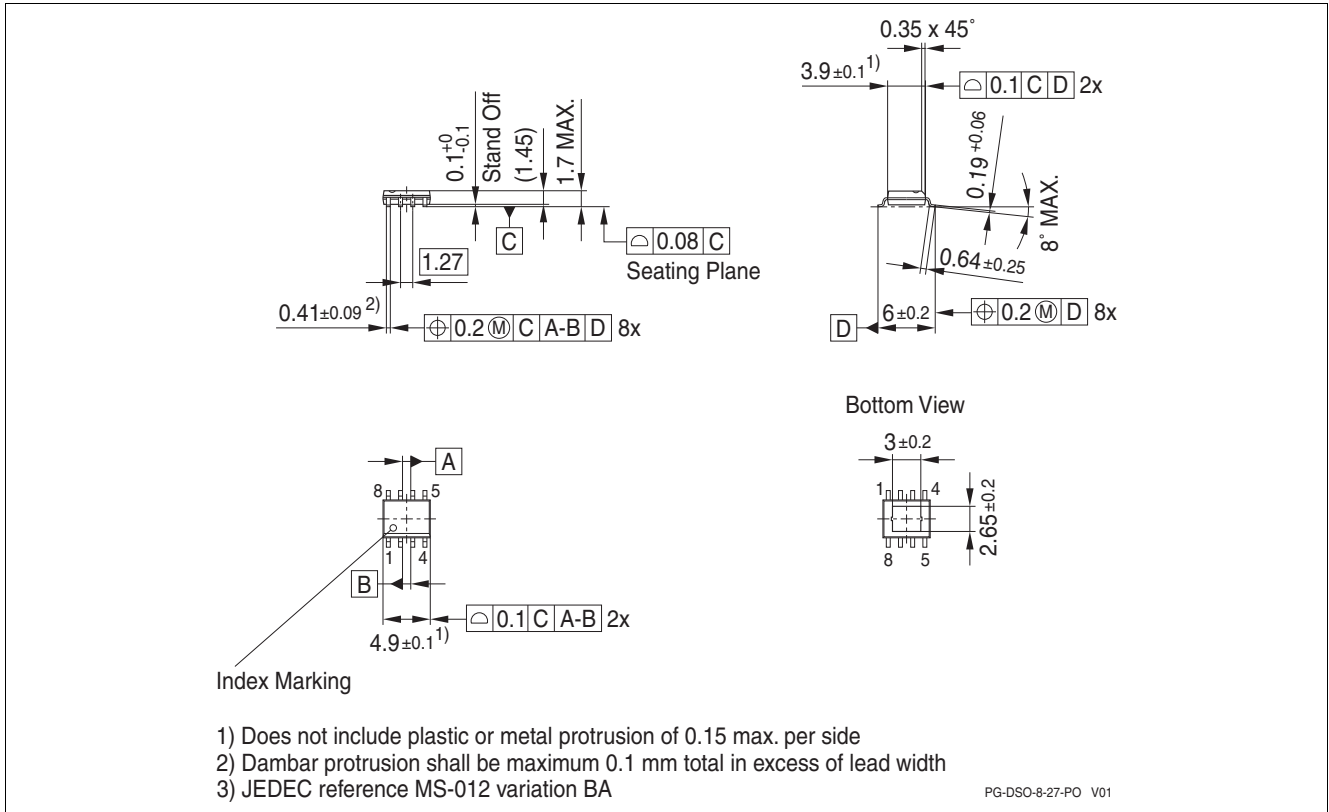

Figure 10 Package outline PG-DSO-8-27 (dimensions in mm)

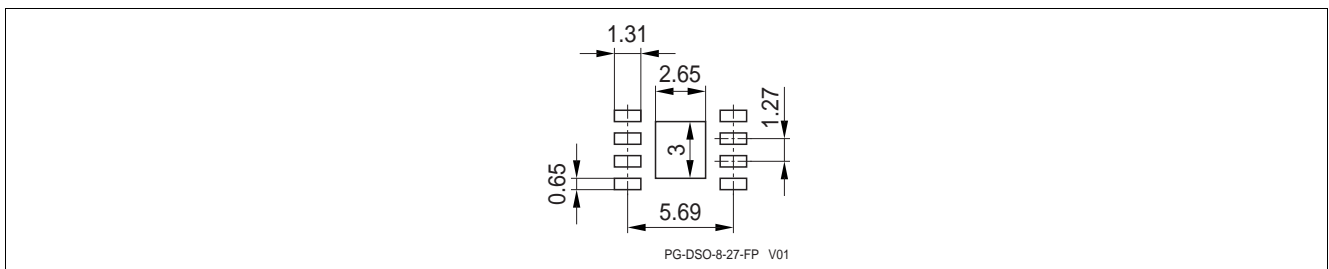

Figure 11 Recommended PCB Footprint for Reflow Soldering (dimensions in mm)

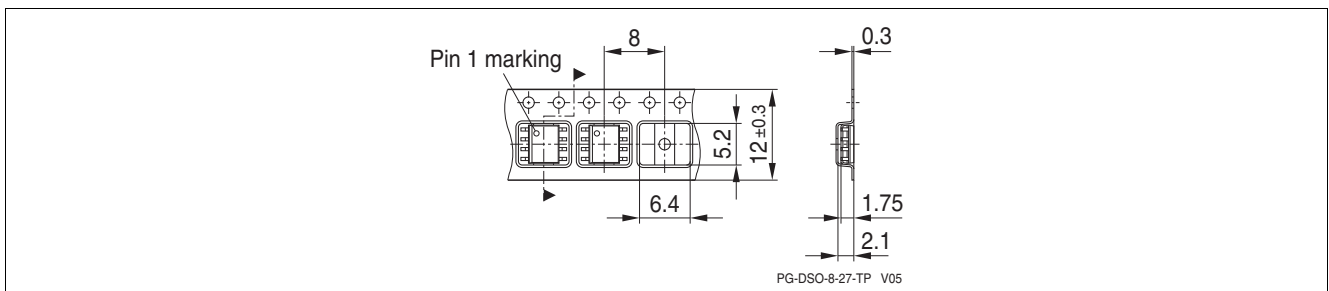

Figure 12 Tape Loading (dimensions in mm)

www.infineon.com

Published by Infineon Technologies AG