

LuxiGen Multi-Color Emitter Series
LZ4-Plus RGBW Flat Lens Emitter

LZ4-04MDCA

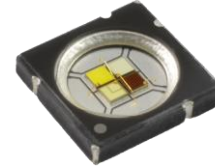

Key Features

- RGBW multi-channel surface mount ceramic LED package with integrated flat glass lens
- Individually addressable Red, Green, Blue and Daylight White die
- Designed to minimize étendue going into secondary optics system
- Thermal resistance of 1.1°C/W; 1.5A maximum current
- Small foot print – 7.0mm x 7.0mm
- Electrically neutral thermal path
- JEDEC Level 1 for Moisture Sensitivity Level
- Lead (Pb) free and RoHS compliant
- Reflow solderable (up to 6 cycles)

Typical Applications

- Stage and Studio Lighting
- Effect Lighting
- Accent Lighting
- Display Lighting
- Architectural Lighting

Description

The LZ4-Plus RGBW flat lens emitter contains one red, green, blue and daylight white LED dies closely packed in a low thermal resistance package with integrated flat glass window. This design minimizes the étendue going into secondary optics, which allows lighting designer to produce narrower beams with better color mixing and no fringes. Utilizing a flat glass lens allows the secondary optics to be closer to the die, protecting it and facilitating the use of zoom optics, mixing rods, light pipes and other optics. The high quality materials used in the package are chosen to maximize light output and minimize stresses which results in monumental reliability and lumen maintenance.

Part number options

Base part number

| Part number | Description |
|-----------------|--|
| LZ4-04MDCA-0000 | LZ4-Plus RGBW flat lens emitter |
| LZ4-24MDCA-0000 | LZ4-Plus RGBW flat lens emitter on Standard Star 4 channel MCPCB |

Bin kit option codes

| MD, Red-Green-Blue-White (6500K) | | | |
|----------------------------------|--------------|------------------|---|
| Kit number suffix | Min flux Bin | Color Bin Ranges | Description |
| 0000 | 07R | R01 – R01 | Red, full distribution flux; full distribution wavelength |
| | 10G | G2 – G3 | Green, full distribution flux; full distribution wavelength |
| | 09B | B03 – B03 | Blue, full distribution flux; full distribution wavelength |
| | 06W | 1V2U | White full distribution flux and CCT |

Daylight White Chromaticity Groups

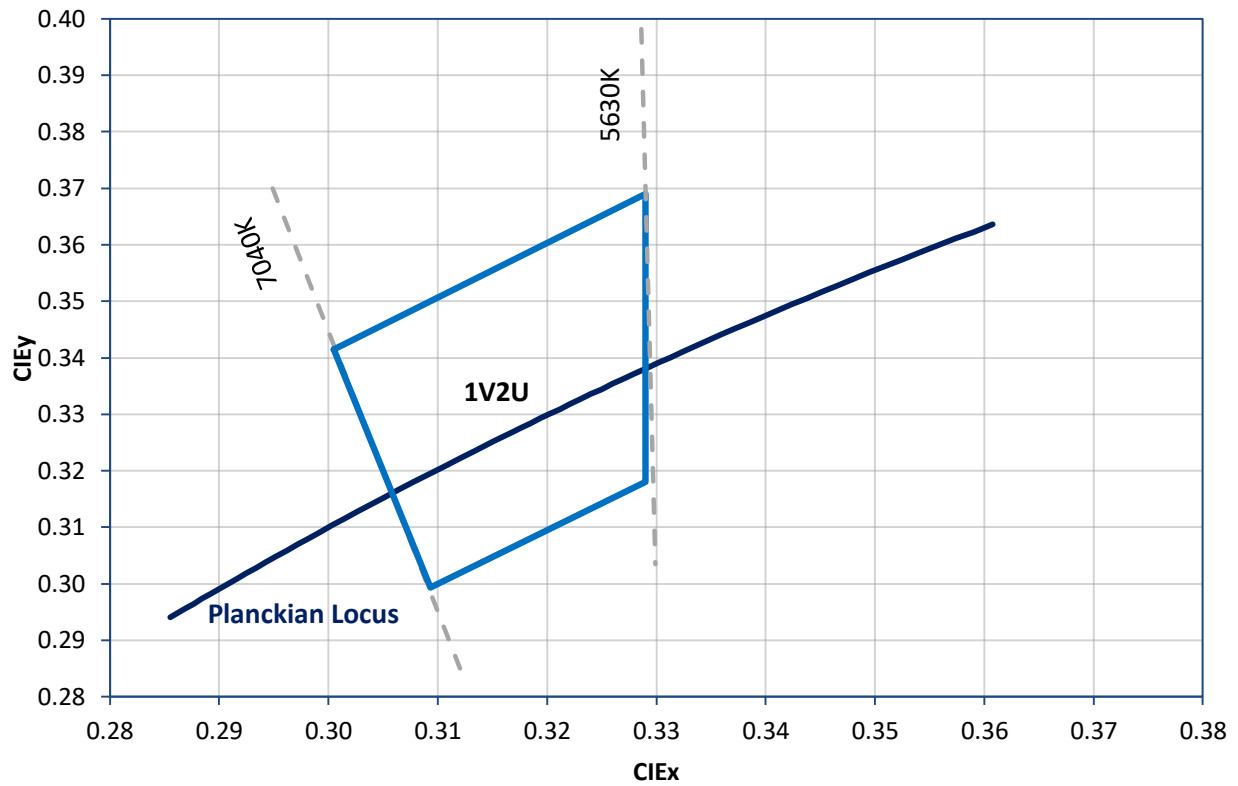

Standard Chromaticity Groups plotted on excerpt from the CIE 1931 (2°) x-y Chromaticity Diagram. Coordinates are listed below.

Daylight White Bin Coordinates

| Bin Code | CIE x | CIE y |
|----------|--------|--------|
| 1V2U | 0.3005 | 0.3415 |
| | 0.329 | 0.369 |
| | 0.329 | 0.318 |
| | 0.3093 | 0.2993 |
| | 0.3005 | 0.3415 |

Luminous Flux Bins

Table 1:

| Bin Code | Minimum Luminous Flux (Φ_v) @ $I_F = 700\text{mA}$ ^[1,2] (lm) | | | | Maximum Luminous Flux (Φ_v) @ $I_F = 700\text{mA}$ ^[1,2] (lm) | | | |
|----------|--|-------|------|-------|--|-------|------|-------|
| | Red | Green | Blue | White | Red | Green | Blue | White |
| | 07R | 60 | | | | 105 | | |
| 10G | | 100 | | | | 166 | | |
| 09B | | | 13 | | | | 22 | |
| 10B | | | 22 | | | | 35 | |
| 06W | | | | 140 | | | | 225 |

Notes for Table 1:

1. Luminous flux performance guaranteed within published operating conditions. LED Engin maintains a tolerance of $\pm 10\%$ on flux measurements.
2. Future products will have even higher levels of radiant flux performance. Contact LED Engin Sales for updated information.

Dominant Wavelength Bins

Table 2:

| Bin Code | Minimum Dominant Wavelength (λ_D) @ $I_F = 700\text{mA}$ ^[1] (nm) | | | Maximum Dominant Wavelength (λ_D) @ $I_F = 700\text{mA}$ ^[1] (nm) | | |
|----------|---|-------|------|---|-------|------|
| | Red | Green | Blue | Red | Green | Blue |
| | R01 | 617 | | | 630 | |
| G2 | | 520 | | | 525 | |
| G3 | | 525 | | | 530 | |
| B03 | | | 453 | | | 460 |

Notes for Table 2:

1. LED Engin maintains a tolerance of $\pm 1.0\text{nm}$ on dominant wavelength measurements.

Forward Voltage Bin

Table 3:

| Bin Code | Minimum Forward Voltage (V_F) @ $I_F = 700\text{mA}$ ^[1] (V) | | | | Maximum Forward Voltage (V_F) @ $I_F = 700\text{mA}$ ^[1] (V) | | | |
|----------|--|-------|------|-------|--|-------|------|-------|
| | Red | Green | Blue | White | Red | Green | Blue | White |
| | 0 | 2.10 | 3.20 | 2.80 | 2.80 | 2.90 | 4.20 | 3.80 |

Notes for Table 3:

1. LED Engin maintains a tolerance of $\pm 0.04\text{V}$ on forward voltage measurements.

Absolute Maximum Ratings

Table 4:

| Parameter | Symbol | Value | Unit |
|---|------------------|---|------|
| DC Forward Current (@T _J = 90°C) ^[1] | I _F | 1500 | mA |
| DC Forward Current (@T _J = 125°C) ^[1] | I _F | 1000 | mA |
| Peak Pulsed Forward Current ^[2] | I _{FP} | 2000 | mA |
| Reverse Voltage | V _R | See Note 3 | V |
| Storage Temperature | T _{std} | -40 ~ +150 | °C |
| Junction Temperature | T _J | 125 | °C |
| Soldering Temperature ^[4] | T _{sol} | 260 | °C |
| Allowable Reflow Cycles | | 6 | |
| ESD Sensitivity ^[5] | | > 8,000 V HBM Class 3B JESD22-A114-D | |

Notes for Table 4:

- Maximum DC forward current is determined by the overall thermal resistance and ambient temperature. Follow the curves in Figure 11 for current derating.
- Pulse forward current conditions: Pulse Width ≤ 10msec and Duty Cycle ≤ 10%.
- LEDs are not designed to be reversing biased.
- Solder conditions per JEDEC 020D. See Reflow Soldering Profile Figure 4.
- LED Engin recommends taking reasonable precautions towards possible ESD damages and handling the emitter in an electrostatic protected area (EPA). An EPA may be adequately protected by ESD controls as outlined in ANSI/ESD S6.1.

Optical Characteristics @T_C = 25°C

Table 5:

| Parameter | Symbol | Typical | | | | Unit |
|---|------------------|---------|-------|---------------------|-------|---------|
| | | Red | Green | Blue ^[1] | White | |
| Luminous Flux (@ I _F = 700mA) | Φ _V | 79 | 140 | 33 | 210 | lm |
| Luminous Flux (@ I _F = 1000mA) | Φ _V | 110 | 180 | 43 | 285 | lm |
| Luminous Flux (@ I _F = 1500mA) | Φ _V | 160 | 220 | 58 | 370 | lm |
| Dominant Wavelength | | 623 | 523 | 457 | | |
| Correlated Color Temperature | CCT | | | | 6500 | K |
| Color Rendering Index (CRI) | R _a | | | | 75 | |
| Viewing Angle ^[2] | 2Θ _½ | | 110 | | | |
| Total Included Angle ^[3] | Θ _{0.9} | | 150 | | | Degrees |

Notes for Table 5:

- When operating the Blue LED, observe IEC 60825-1 class 2 rating. Do not stare into the beam.
- Viewing Angle is the off axis angle from emitter centerline where the luminous intensity is ½ of the peak value.
- Total Included Angle is the total angle that includes 90% of the total luminous flux.

Electrical Characteristics @T_C = 25°C

Table 6:

| Parameter | Symbol | Typical | | | | Unit |
|--|----------------------------------|---------|-------|------|-------|-------|
| | | Red | Green | Blue | White | |
| Forward Voltage (@ I _F = 700mA) | V _F | 2.5 | 3.6 | 3.2 | 3.2 | V |
| Temperature Coefficient of Forward Voltage | ΔV _F /ΔT _J | -1.9 | -2.9 | -2.0 | -2.0 | mV/°C |
| Thermal Resistance (Junction to Case) | RO _{J-C} | | 1.1 | | | °C/W |

IPC/JEDEC Moisture Sensitivity Level

Table 7 - IPC/JEDEC J-STD-20D.1 MSL Classification:

| Level | Floor Life | | Soak Requirements | | | |
|-------|------------|-------------------|-------------------|-----------------|------------|------------|
| | Time | Conditions | Standard | Accelerated | Time (hrs) | Conditions |
| 1 | Unlimited | ≤ 30°C/ 85% RH | 168 +5/-0 | 85°C/ 85% RH | n/a | n/a |

Notes for Table 7:

1. The standard soak time includes a default value of 24 hours for semiconductor manufacturer's exposure time (MET) between bake and bag and includes the maximum time allowed out of the bag at the distributor's facility.

Average Lumen Maintenance Projections

Lumen maintenance generally describes the ability of a lamp to retain its output over time. The useful lifetime for solid state lighting devices (Power LEDs) is also defined as Lumen Maintenance, with the percentage of the original light output remaining at a defined time period.

Based on long-term HTOL testing, LED Engin projects that LZ4-04MDCA will deliver, on average, 70% Lumen Maintenance at 40,000 hours of operation at a forward current of 1500mA. This projection assumes 25% duty cycle with junction temperature maintained at or below 90°C.

Mechanical Dimensions (mm)

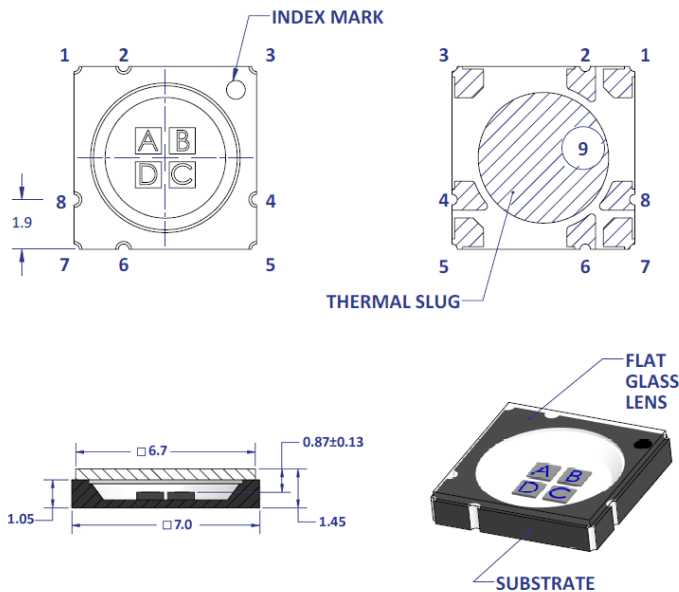

| Pin Out | | | |
|------------------|-----|-------|----------|
| Pad | Die | Color | Function |
| 1 | A | Red | Anode |
| 2 | A | Red | Cathode |
| 3 | B | Green | Anode |
| 4 | B | Green | Cathode |
| 5 | C | White | Cathode |
| 6 | C | White | Anode |
| 7 | D | Blue | Cathode |
| 8 | D | Blue | Anode |
| 9 ^[2] | n/a | n/a | Thermal |

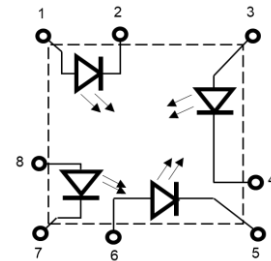

Figure 1: Package Outline Drawing

Notes for Figure 1:

1. Unless otherwise noted, the tolerance = ± 0.20 mm.
2. Nominal die spacing is 0.15mm.
3. Thermal contact, Pad 9, is electrically neutral.

Recommended Solder Pad Layout (mm)

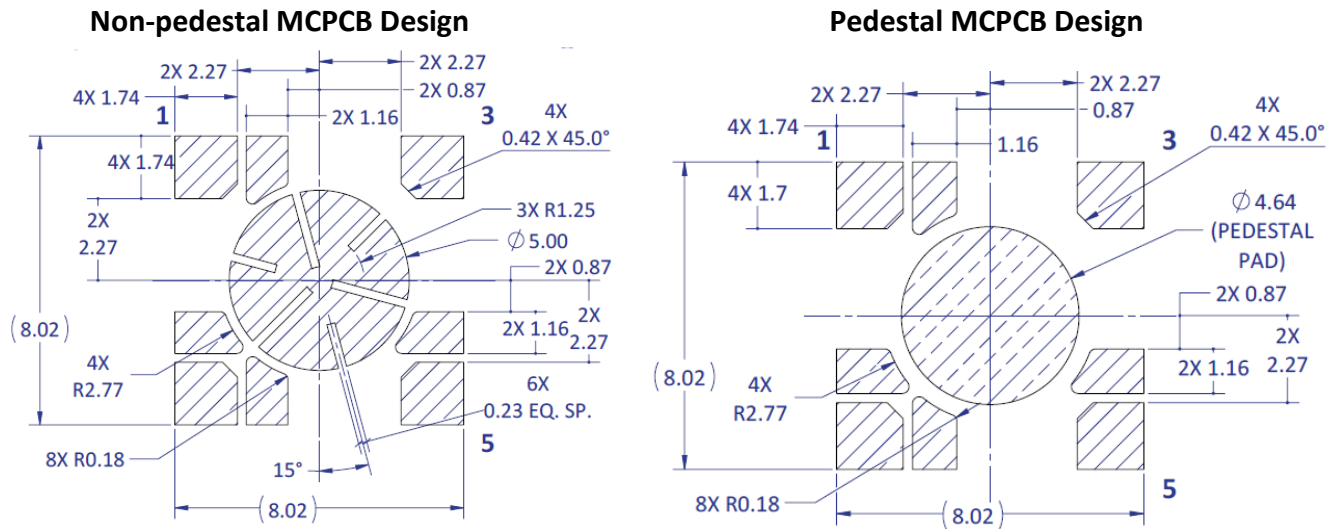

Figure 2a: Recommended solder pad layout for anode, cathode, and thermal pad for non-pedestal and pedestal design

Note for Figure 2a:

1. Unless otherwise noted, the tolerance = ± 0.20 mm.
2. Pedestal MCPCB allows the emitter thermal slug to be soldered directly to the metal core of the MCPCB. Such MCPCB eliminate the high thermal resistance dielectric layer that standard MCPCB technologies use in between the emitter thermal slug and the metal core of the MCPCB, thus lowering the overall system thermal resistance.
3. LED Engin recommends x-ray sample monitoring for solder voids underneath the emitter thermal slug. The total area covered by solder voids should be less than 20% of the total emitter thermal slug area. Excessive solder voids will increase the emitter to MCPCB thermal resistance and may lead to higher failure rates due to thermal over stress.

Recommended Solder Mask Layout (mm)

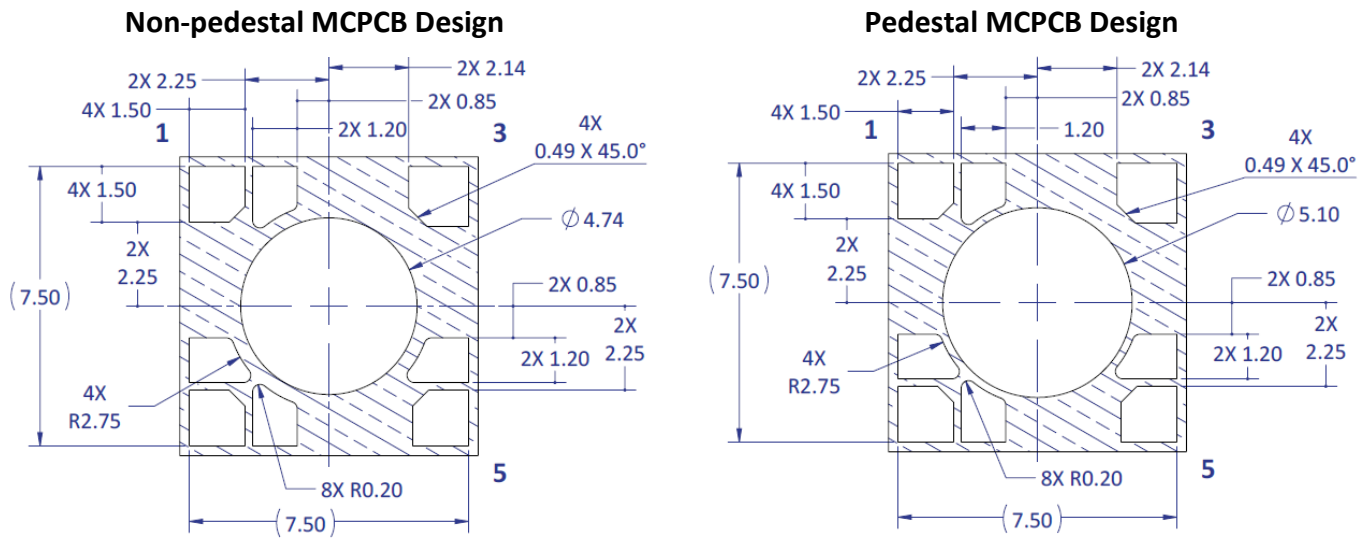

Figure 2b: Recommended solder mask opening for anode, cathode, and thermal pad for non-pedestal and pedestal design

Note for Figure 2b:

1. Unless otherwise noted, the tolerance = ± 0.20 mm.

Recommended 8 mil Stencil Apertures Layout (mm)

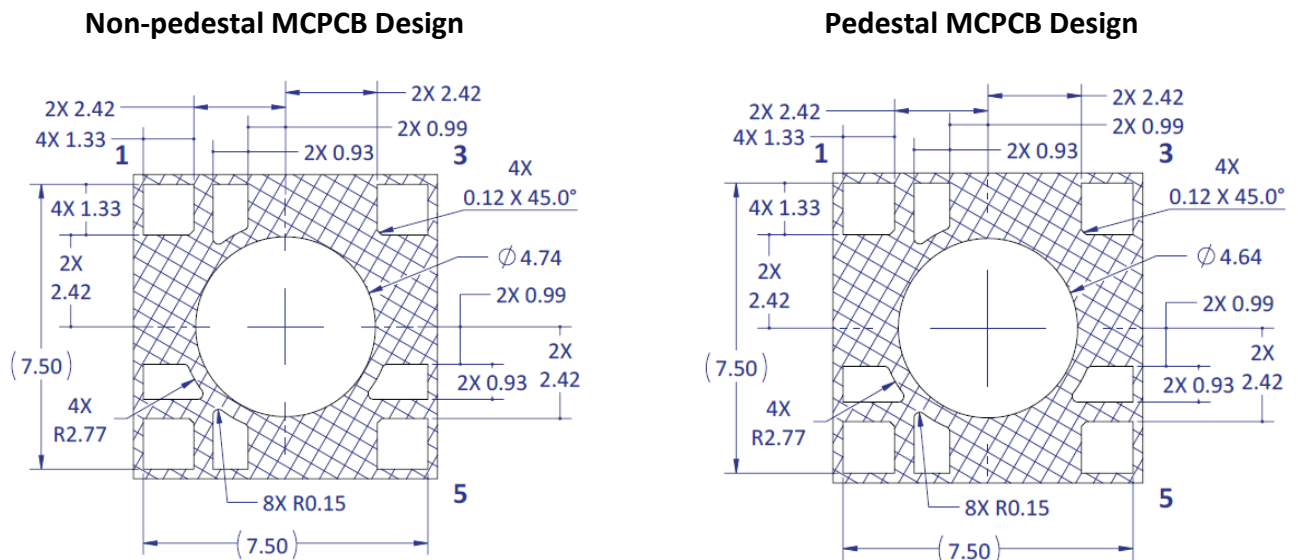

Figure 2c: Recommended 8mil stencil apertures for anode, cathode, and thermal pad for non-pedestal and pedestal design

Note for Figure 2c:

1. Unless otherwise noted, the tolerance = ± 0.20 mm.

Reflow Soldering Profile

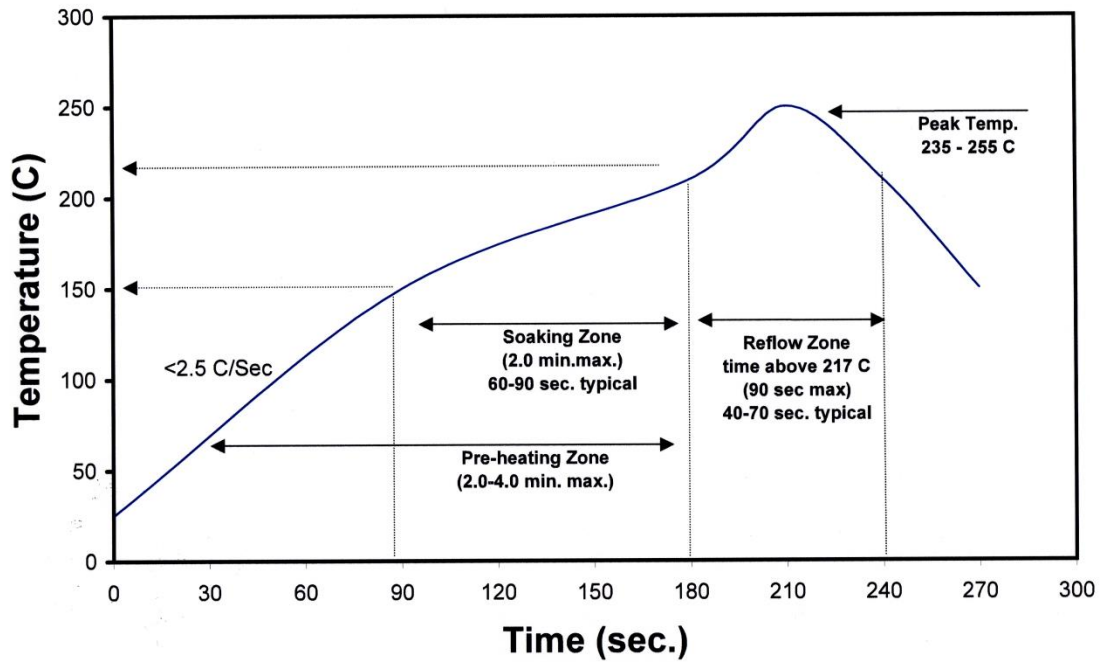

Figure 3: Reflow soldering profile for lead free soldering

Typical Radiation Pattern

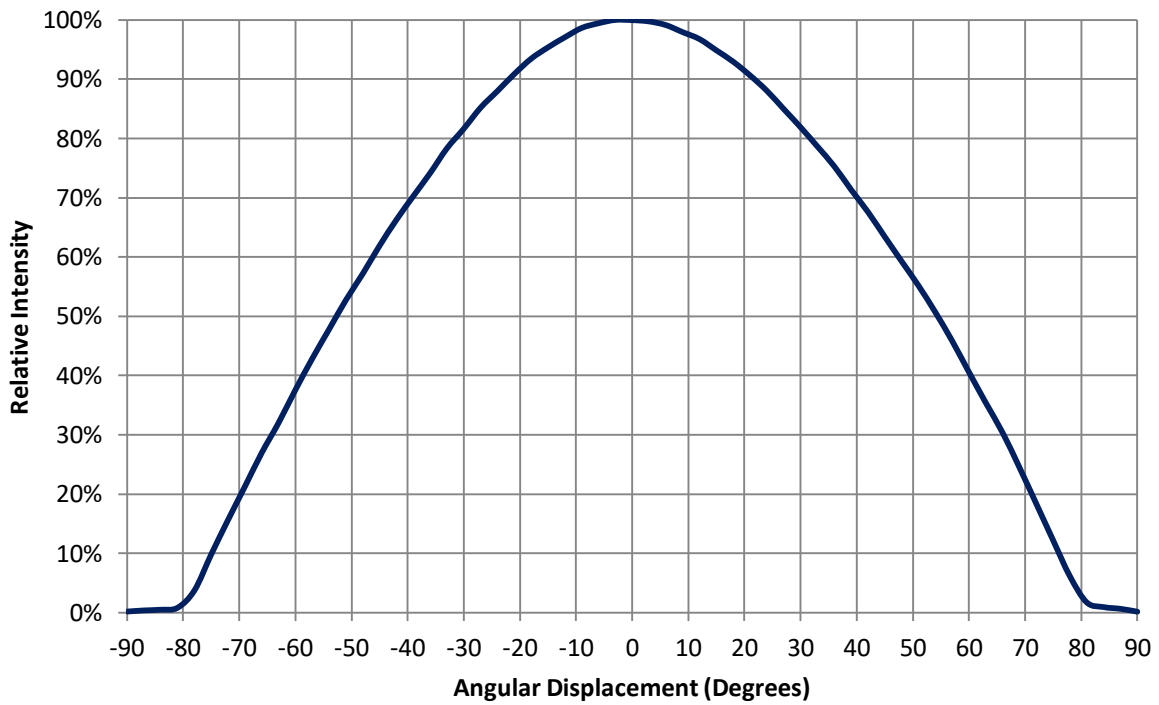

Figure 4: Typical representative spatial radiation pattern

Typical Relative Spectral Power Distribution

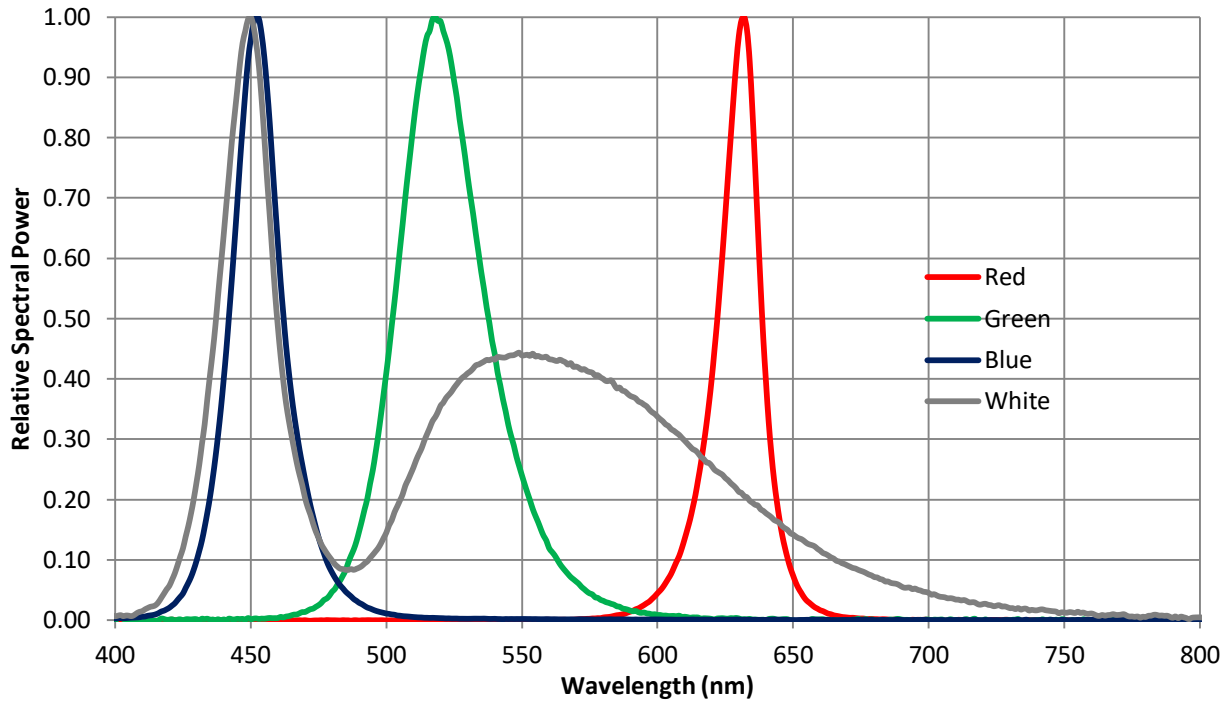

Figure 5: Typical relative spectral power vs. wavelength @ T_c = 25°C.

Typical Forward Current Characteristics

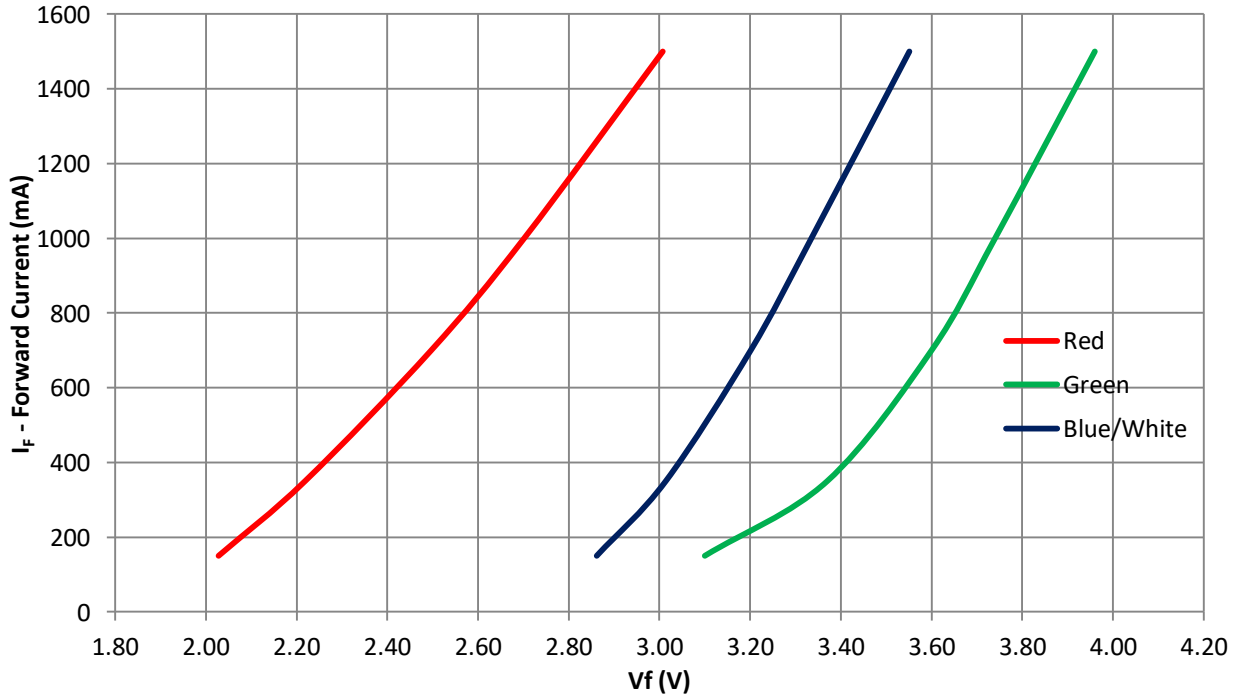

Figure 6: Typical forward current vs. forward voltage @ T_c = 25°C

Typical Relative Light Output over Current

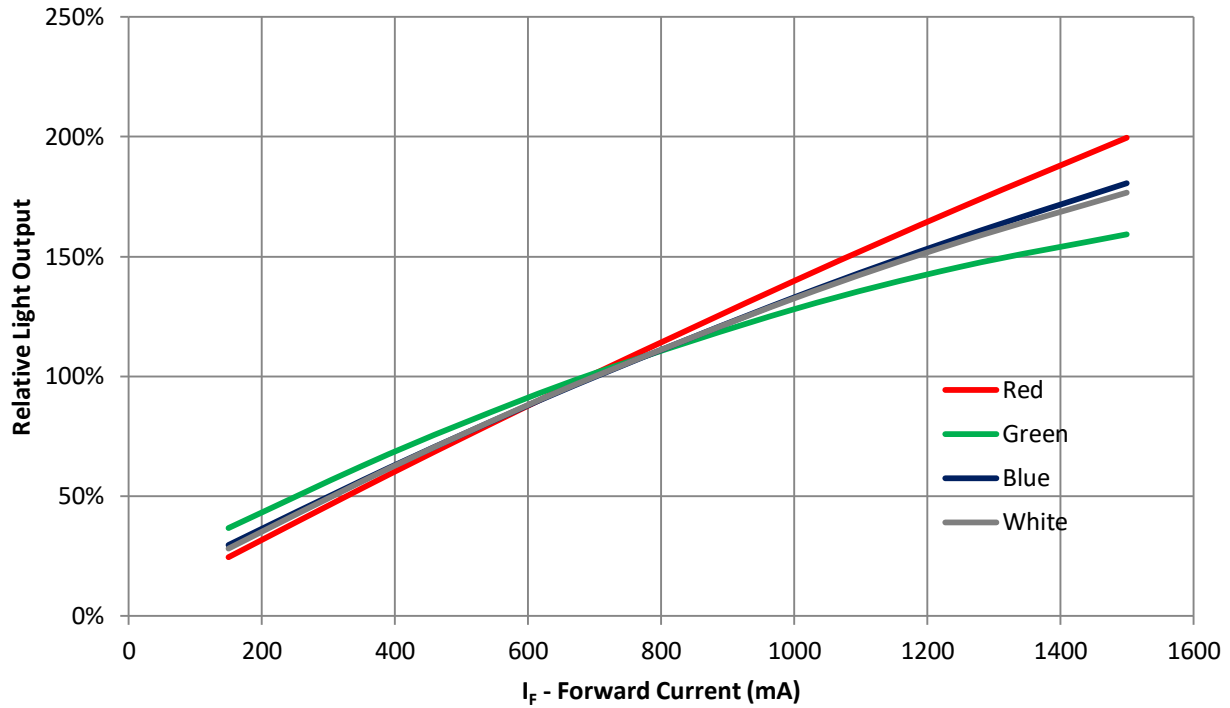

Figure 7: Typical relative light output vs. forward current @ T_c = 25°C

Typical Relative Light Output over Temperature

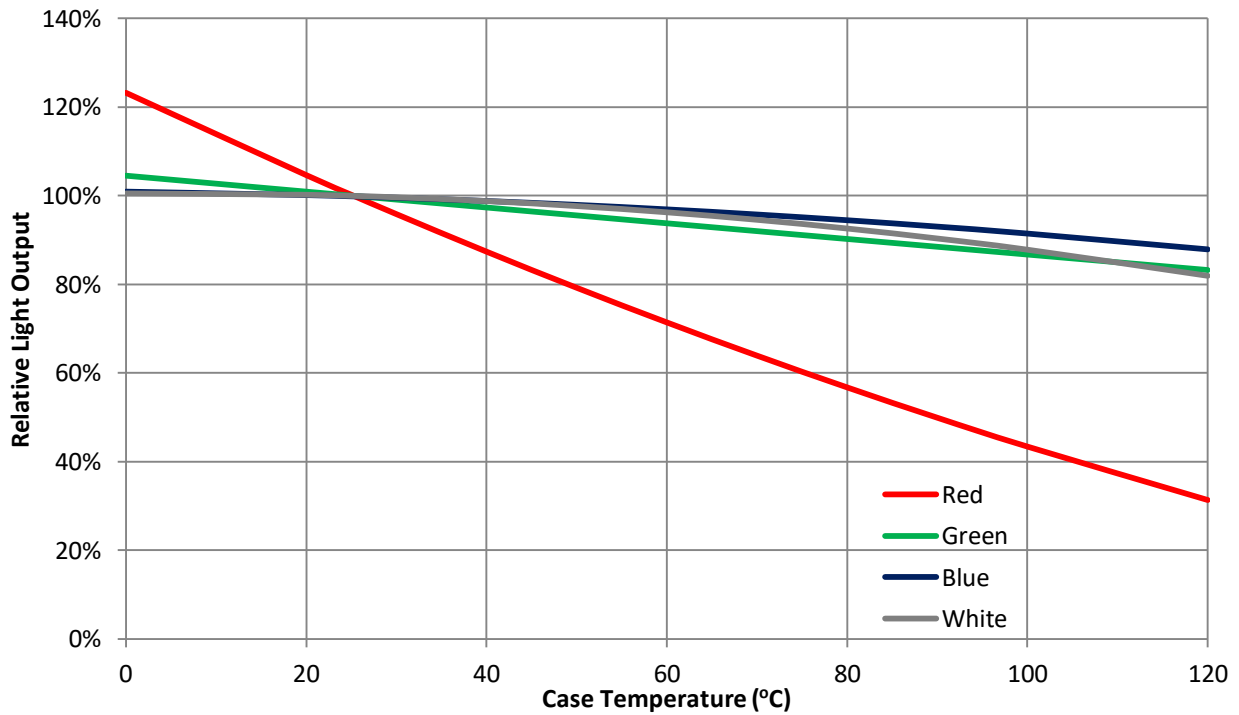

Figure 8: Typical relative light output vs. case temperature.

Typical Dominant Wavelength/Chromaticity Coordinate Shift over Current

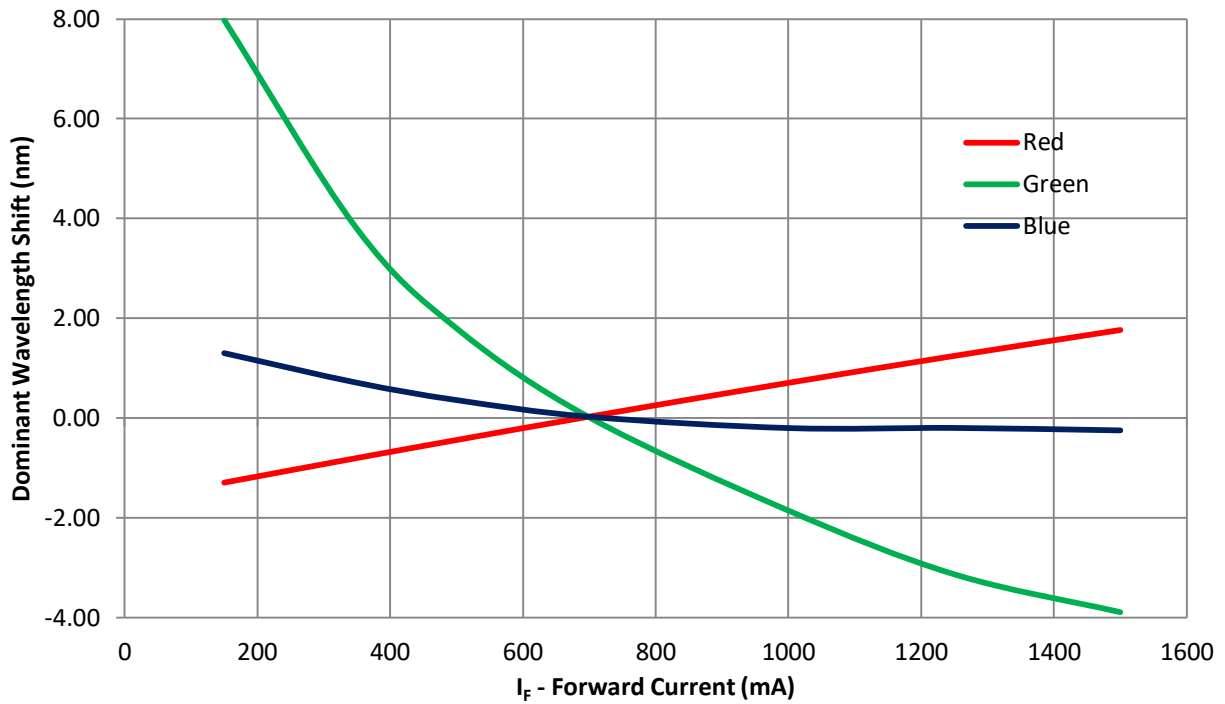

Figure 9a: Typical dominant wavelength shift vs. forward current @ $T_c = 25^\circ\text{C}$.

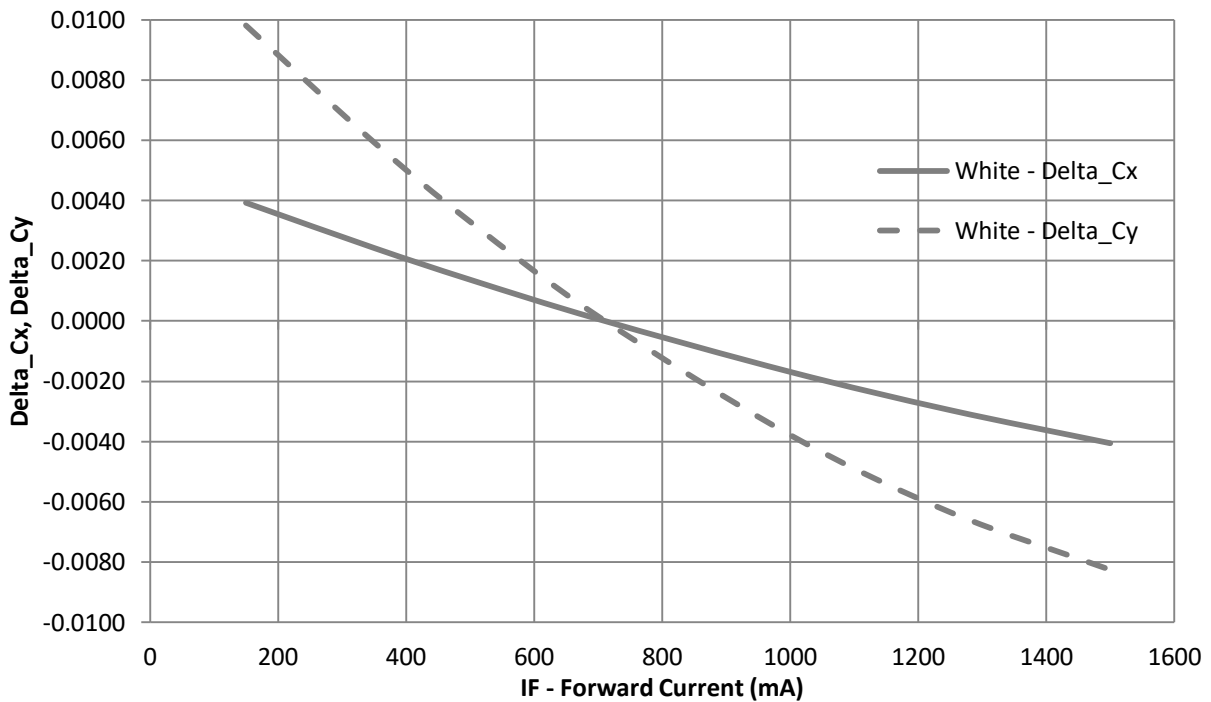

Figure 9b: Typical chromaticity coordinate shift vs. forward current @ $T_c = 25^\circ\text{C}$.

Typical Dominant Wavelength/Chromaticity Coordinate Shift over Temperature

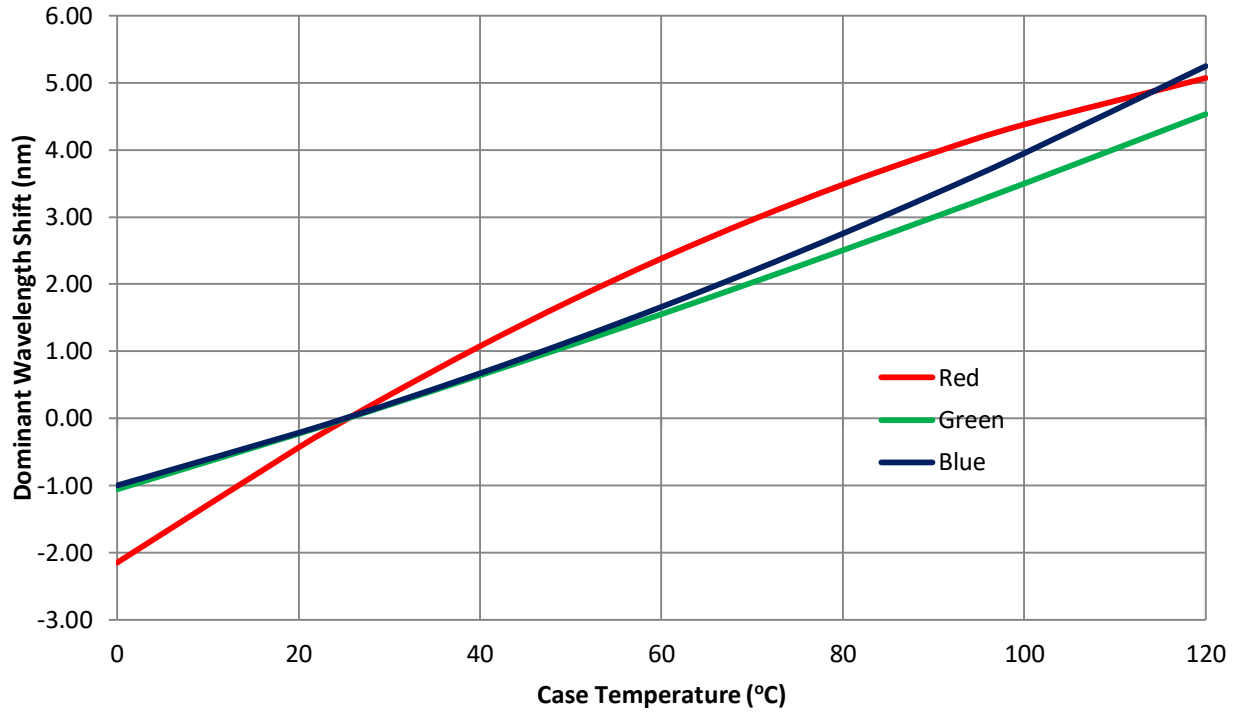

Figure 10a: Typical dominant wavelength shift vs. case temperature

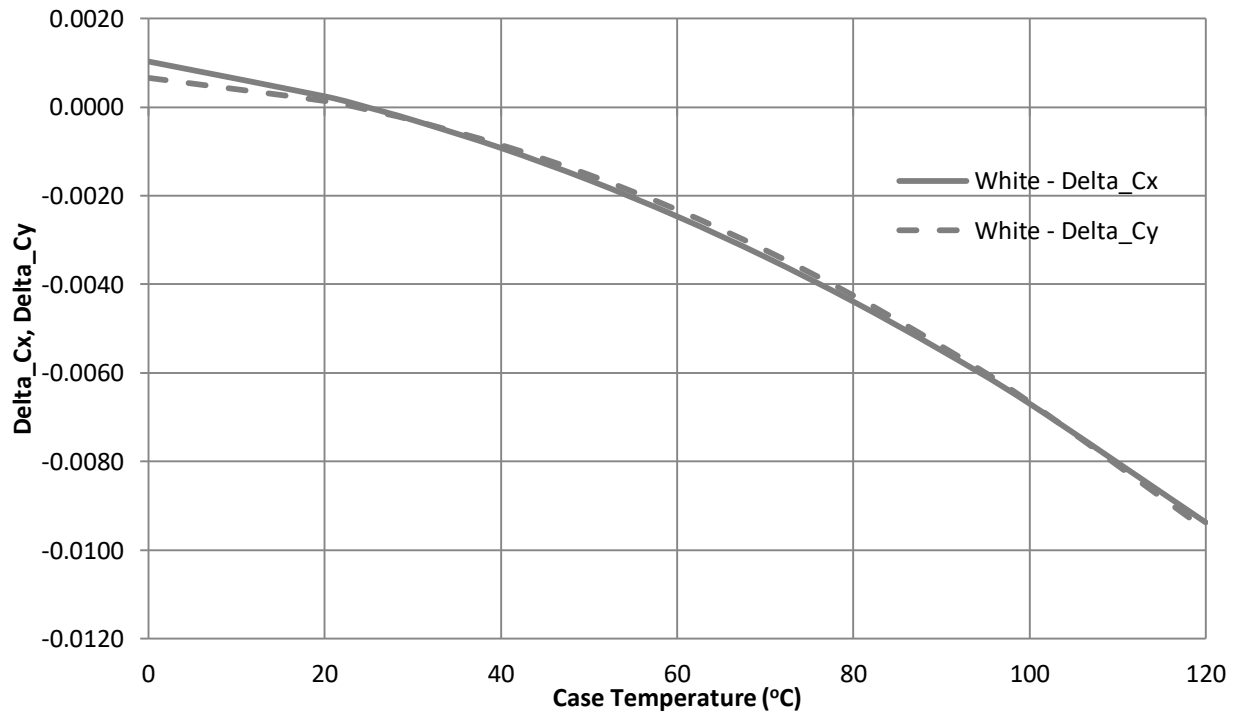

Figure 10b: Typical chromaticity coordinate shift vs. case temperature

Current De-rating

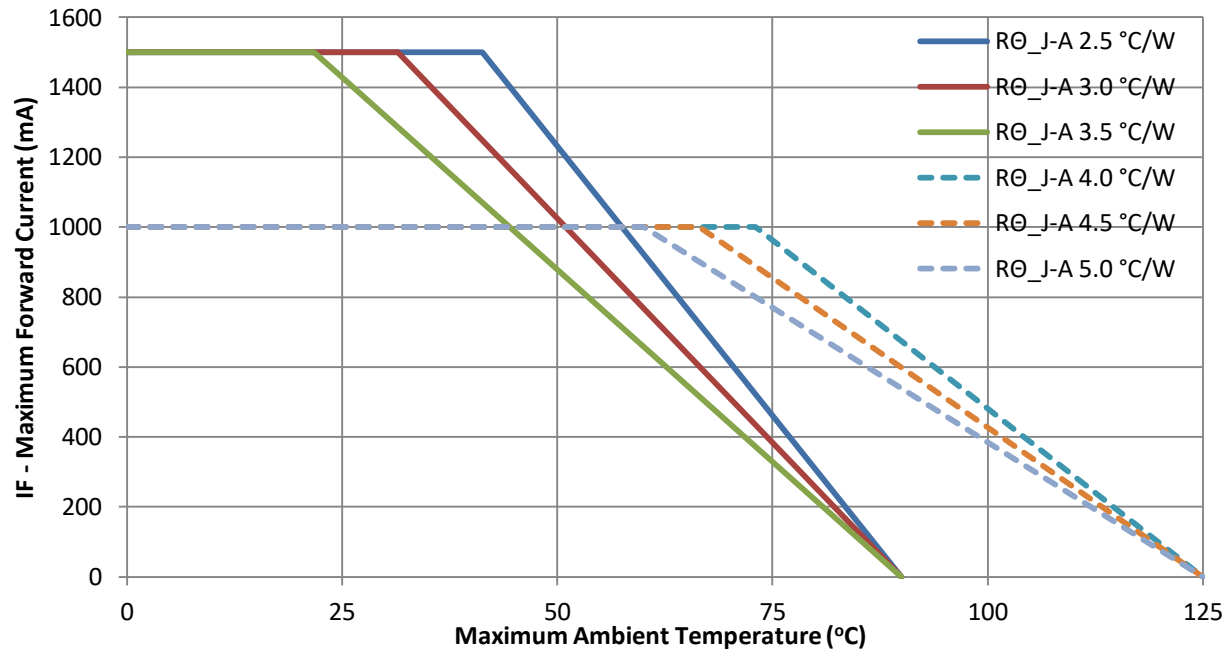

Figure 11: Maximum forward current vs. ambient temperature

Notes for Figure 11:

1. Maximum current assumes that all four LED dice are operating concurrently at the same current.
2. $R_{\theta_{J-C}}$ [Junction to Case Thermal Resistance] for LZ4-04MDCA is 1.1°C/W.
3. $R_{\theta_{J-A}}$ [Junction to Ambient Thermal Resistance] = $R_{\theta_{J-C}}$ + $R_{\theta_{C-A}}$ [Case to Ambient Thermal Resistance].

Emitter Tape and Reel Specifications (mm)

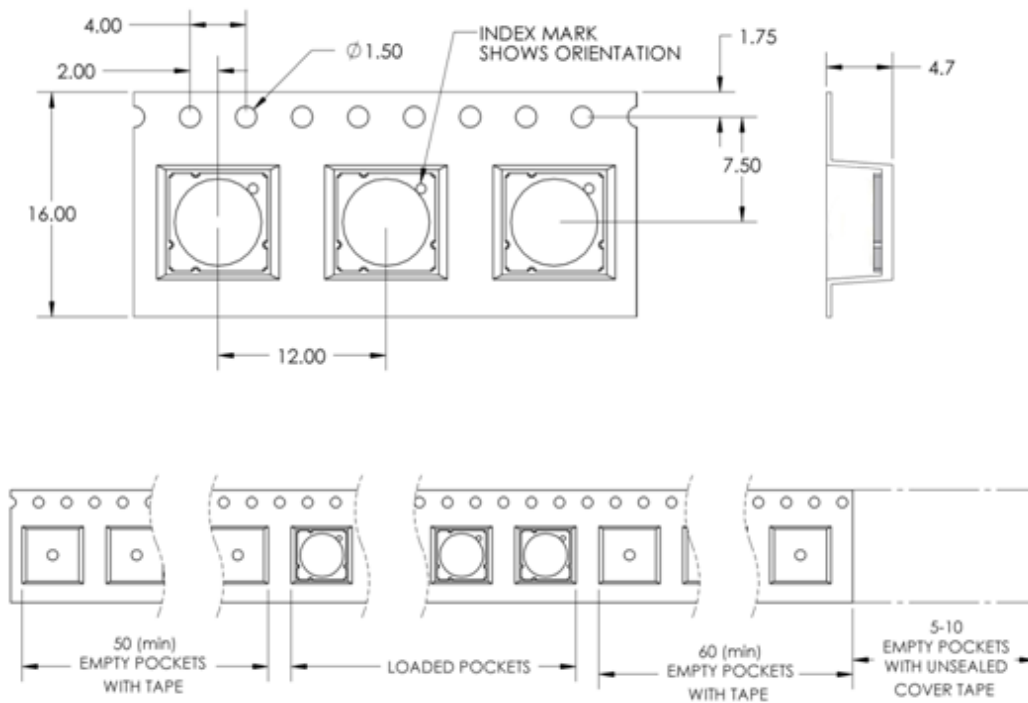

Figure 12: Emitter carrier tape specifications (mm).

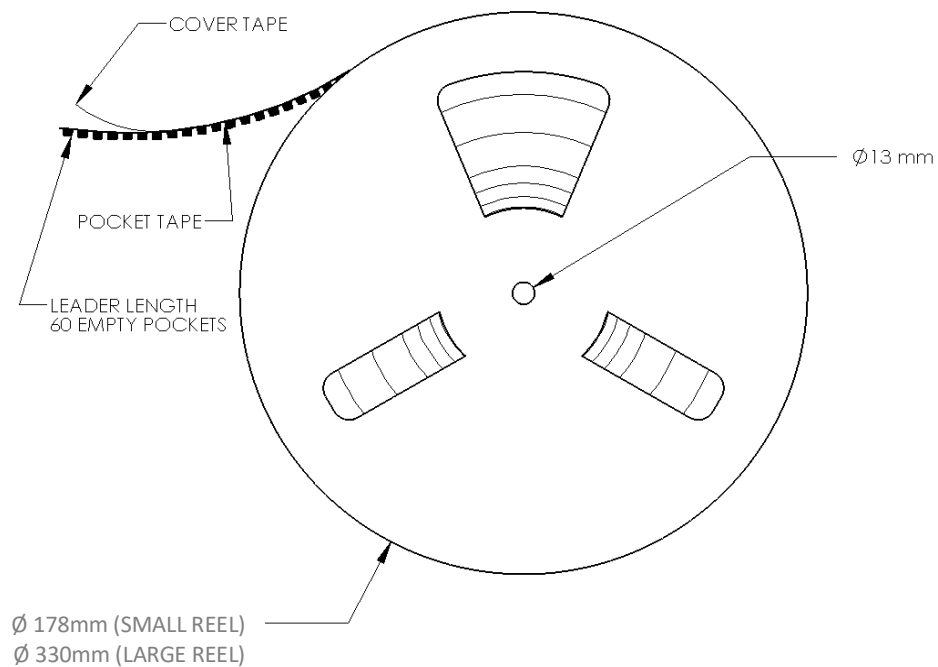

Figure 13: Emitter reel specifications (mm).

Notes for Figure 13:

1. Small reel quantity: up to 250 emitters
2. Large reel quantity: 250-2000 emitters.
3. Single flux bin and single wavelength per reel.

LZ4 MCPCB Family

| Part number | Type of MCPCB | Diameter (mm) | Emitter + MCPCB Thermal Resistance (°C/W) | Typical V_f (V) | Typical I_f (mA) |
|-------------|---------------|---------------|---|-------------------|--------------------|
| LZ4-2xxxxx | 4-channel | 19.9 | 1.1 + 1.1 = 2.2 | 2.5 – 3.6 | 700 |

Mechanical Mounting of MCPCB

- MCPCB bending should be avoided as it will cause mechanical stress on the emitter, which could lead to substrate cracking and subsequently LED dies cracking.
- To avoid MCPCB bending:
 - Special attention needs to be paid to the flatness of the heat sink surface and the torque on the screws.
 - Care must be taken when securing the board to the heat sink. This can be done by tightening three M3 screws (or #4-40) in steps and not all the way through at once. Using fewer than three screws will increase the likelihood of board bending.
 - It is recommended to always use plastics washers in combinations with the three screws.
 - If non-taped holes are used with self-tapping screws, it is advised to back out the screws slightly after tightening (with controlled torque) and then re-tighten the screws again.

Thermal interface material

- To properly transfer heat from LED emitter to heat sink, a thermally conductive material is required when mounting the MCPCB on to the heat sink.
- There are several varieties of such material: thermal paste, thermal pads, phase change materials and thermal epoxies. An example of such material is Electrolube EHTC.
- It is critical to verify the material's thermal resistance to be sufficient for the selected emitter and its operating conditions.

Wire soldering

- To ease soldering wire to MCPCB process, it is advised to preheat the MCPCB on a hot plate of 125-150°C. Subsequently, apply the solder and additional heat from the solder iron will initiate a good solder reflow. It is recommended to use a solder iron of more than 60W.
- It is advised to use lead-free, no-clean solder. For example: SN-96.5 AG-3.0 CU 0.5 #58/275 from Kester (pn: 24-7068-7601)

LZ4-2xxxxx

4 channel, Standard Star MCPCB (4x1) Dimensions (mm)

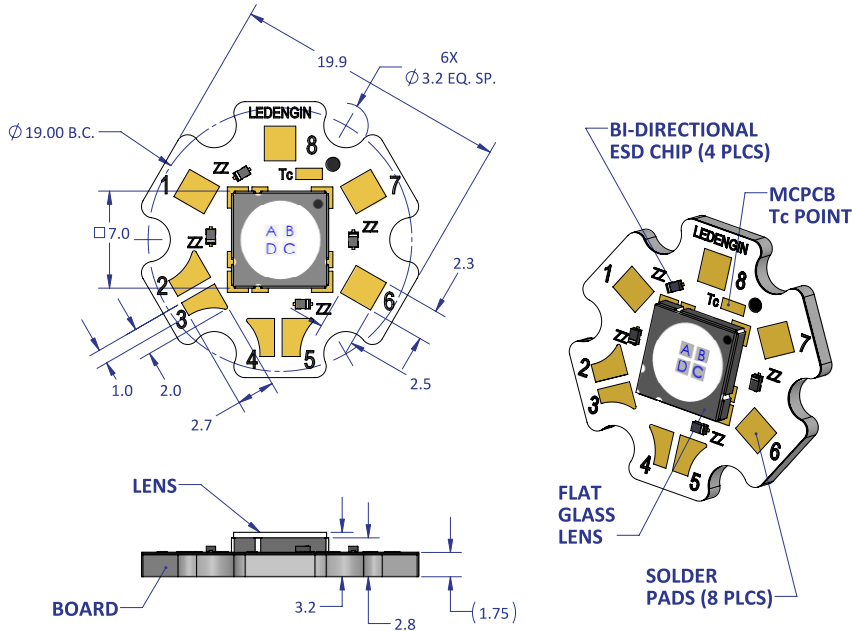

Notes:

- Unless otherwise noted, the tolerance = ± 0.2 mm.
- Slots in MCPCB are for M3 or #4-40 mounting screws.
- LED Engin recommends plastic washers to electrically insulate screws from solder pads and electrical traces.
- LED Engin recommends using thermal interface material when attaching the MCPCB to a heatsink.
- The thermal resistance of the MCPCB is: $R_{\theta C-B}$ 1.1°C/W

Components used

MCPCB: HT04503 (Bergquist)
ESD chips: BZT52C5-C10 (NXP, for 1 LED die)

| Pad layout | | | |
|------------|-----------|------------|-----------|
| Ch. | MCPCB Pad | String/die | Function |
| 1 | 1 | 1/A | Anode + |
| | 8 | | Cathode - |
| 2 | 7 | 2/B | Anode + |
| | 6 | | Cathode - |
| 3 | 4 | 3/C | Anode + |
| | 5 | | Cathode - |
| 4 | 2 | 4/D | Anode + |
| | 3 | | Cathode - |

About LED Engin

LED Engin, an OSRAM business based in California's Silicon Valley, develops, manufactures, and sells advanced LED emitters, optics and light engines to create uncompromised lighting experiences for a wide range of entertainment, architectural, general lighting and specialty applications. LuxiGen™ multi-die emitter and secondary lens combinations reliably deliver industry-leading flux density, upwards of 5000 quality lumens to a target, in a wide spectrum of colors including whites, tunable whites, multi-color and UV LEDs in a unique patented compact ceramic package. Our LuxiTune™ series of tunable white lighting modules leverage our LuxiGen emitters and lenses to deliver quality, control, freedom and high density tunable white light solutions for a broad range of new recessed and downlighting applications. The small size, yet remarkably powerful beam output and superior in-source color mixing, allows for a previously unobtainable freedom of design wherever high-flux density, directional light is required. LED Engin is committed to providing products that conserve natural resources and reduce greenhouse emissions; and reserves the right to make changes to improve performance without notice.

For more information, please contact LEDE-Sales@osram.com or +1 408 922-7200.