



## **Application Note: AS8510 - AN03 - Copper Mini Shunt**

# **AS8510**

## **AN03 – Copper Mini Shunt**

## Table of Contents

1	General Description .....	3
1.1	Kit Content .....	3
2	Getting Started .....	3
3	Hardware Description.....	4
4	Software Description .....	5
5	Board Schematics, Layout and BOM.....	6
6	Ordering Information .....	10

## Revision History

Revision	Date	Owner	Description
1.0	28.03.2014	gheh	Initial release

## 1 General Description

This document describes the Copper-Shunt based current sensor demo which utilizes the AS8510 for current measurement and thermal-coefficient compensation.

It is intended for a current range of ~40A operation and 60A maximum.

Two measurement paths are provided. The left one uses the AS8510's internal temperature sensor and the right one uses a fine copper meander trace to sense temperature.

### 1.1 Kit Content

The kit consists of a four layer PCB with all components mounted on the Top Side. Top and bottom are used for routing of digital signals whereas the inner layers transport the current and act as the measurement shunt resistance.



**Figure 1: AS8510-Copper-Shunt Board**

Communication is done via the mini-HDMI Plug on the top side which connects to the USB Interface board and subsequently to the PC via USB.

## 2 Getting Started

To get started setup the USB Interface Board for 3.3V operation as is explained in the according App-Note. Connect the mini HDMI Plug on the left of this board to the micro HDMI Plug of the USB Interface Board. Connect the load across connectors A-B with A being the GND connection. Install the supplied Software. Connect the USB Interface Board to the PC via USB and start the GUI.

### 3 Hardware Description

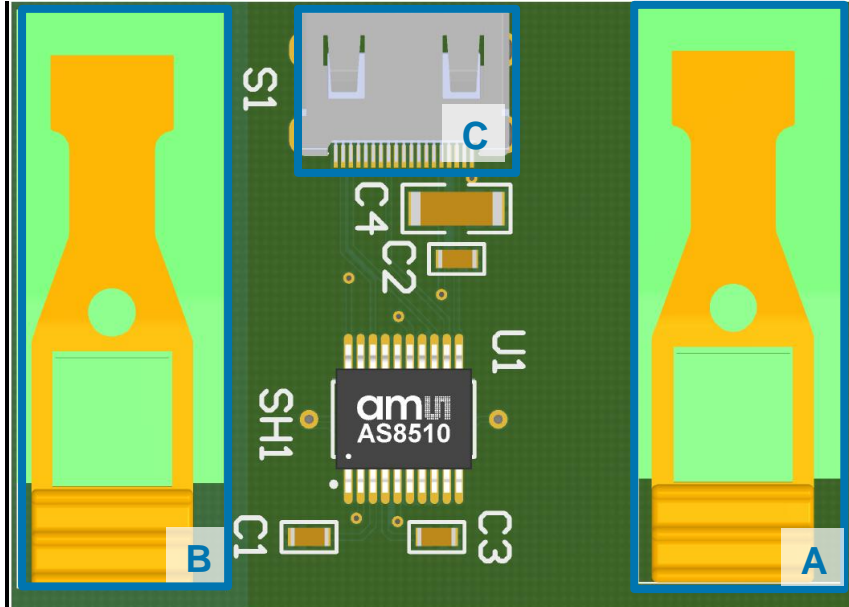
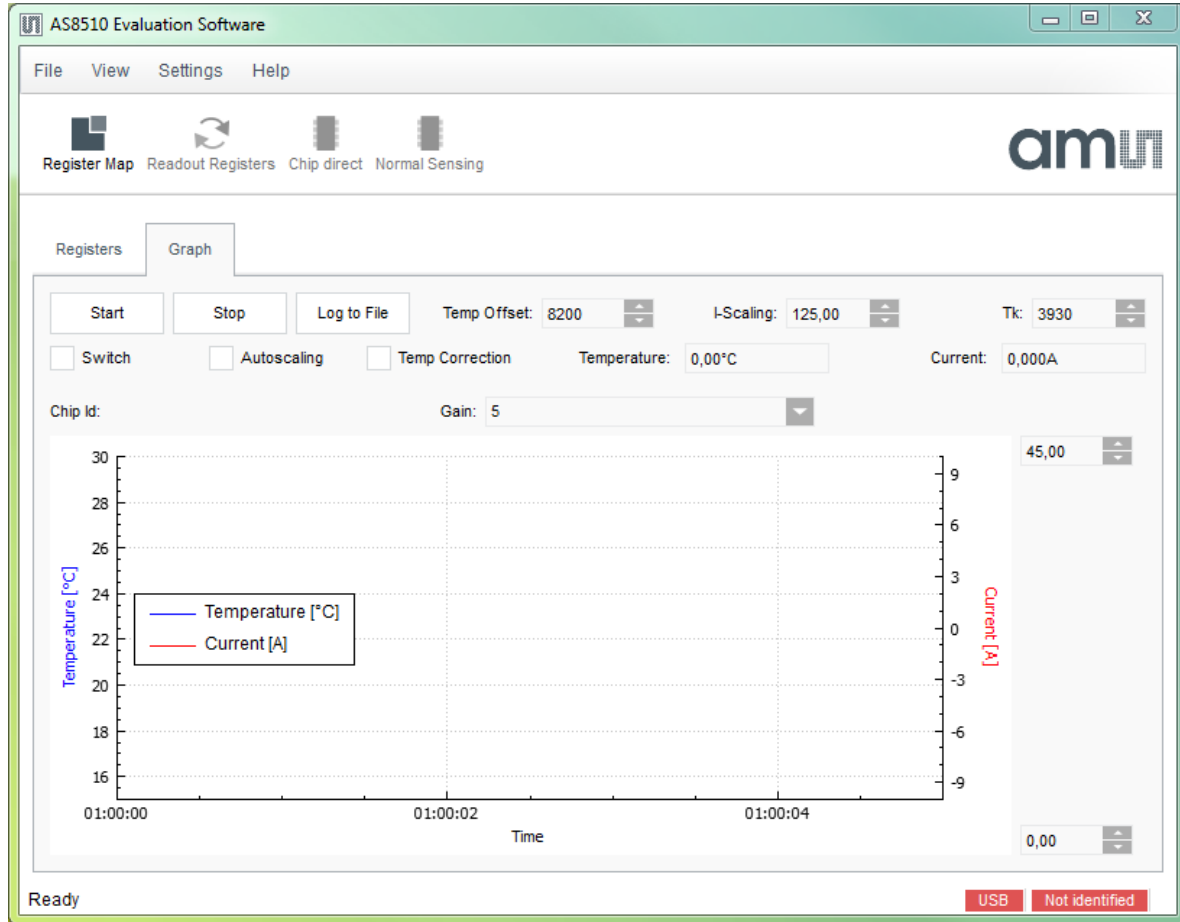

Figure 2: PCB Connection Diagram

Label	Name	Description	Info
A	GND	Measurement path GND connection	AS8510 Temp compensated path
B	LOAD	Measurement path Load connection	
C	HDMI	HDMI SPI Connector	Connects to the USB Interface Board

## 4 Software Description



**Figure 3: AS8510 GUI**

Once started the PC GUI will automatically detect the AS8510 Board connected to the USB Interface and show this in the right-bottom field.

The Start and Stop buttons will commence measurements respectively stop them.

Measured current and temperature is always displayed synchronous with the temperature in blue and current in red.

The *Temp Correction* checkbox enables the temperature correction of the impedance of the copper resistor.

In order to get reliable measurement result the sensor has to be calibrated first.

Ideally the board is exposed to a known temperature without current and the *Temp Offset* is changed until the displayed Temperature is correct.

Then a known low current ~5A is run through the sensor and the *I-Scaling* is also changed accordingly.

Last but not least the current is run through at a higher temperature and the *TK* is changed to accommodate for the copper thermal coefficient. All of these values have a rough starting value but will require some tuning for optimal performance.

## 5 Board Schematics, Layout and BOM

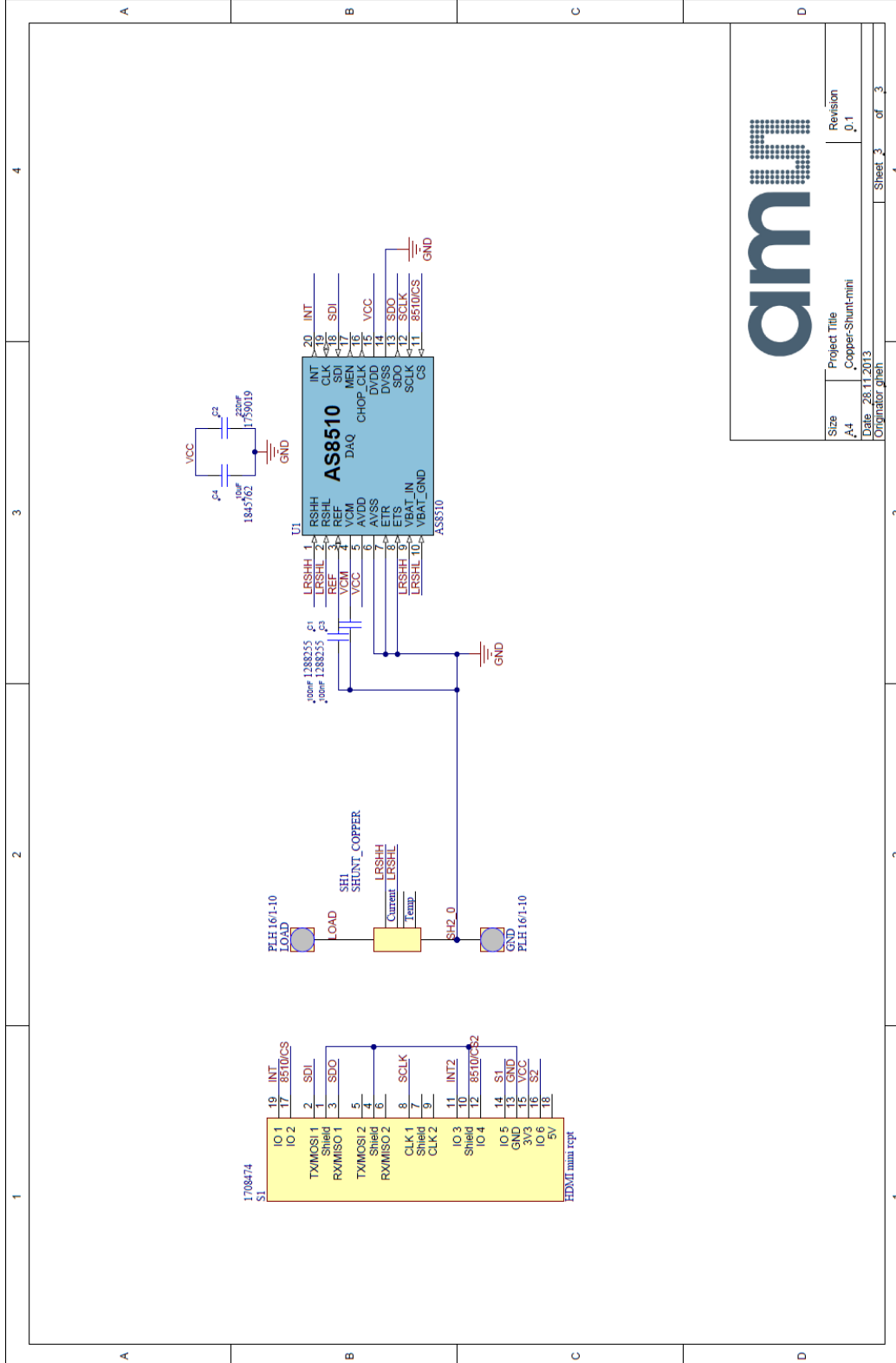

Figure 4: Schematic

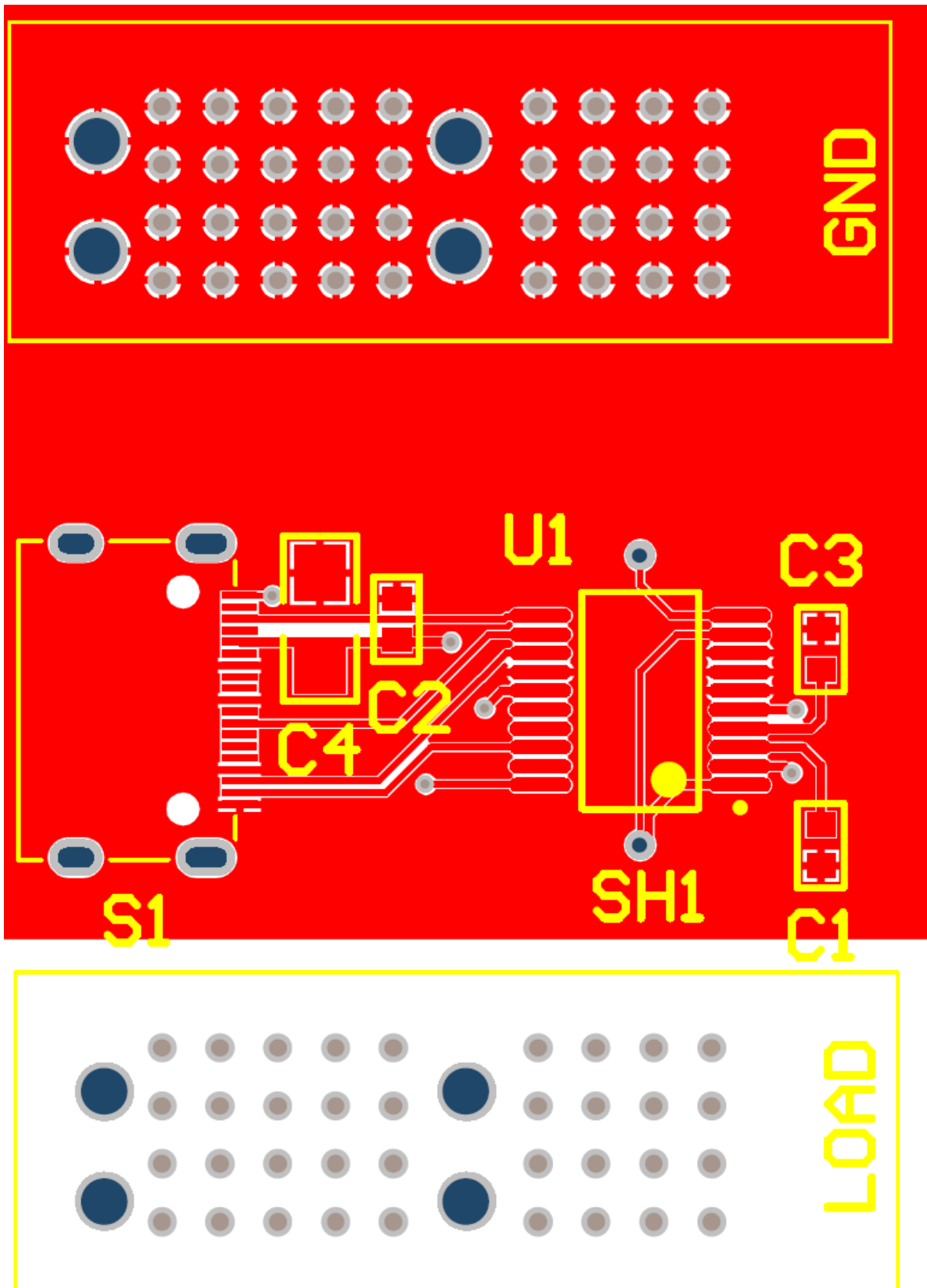

Figure 5: Top Layer

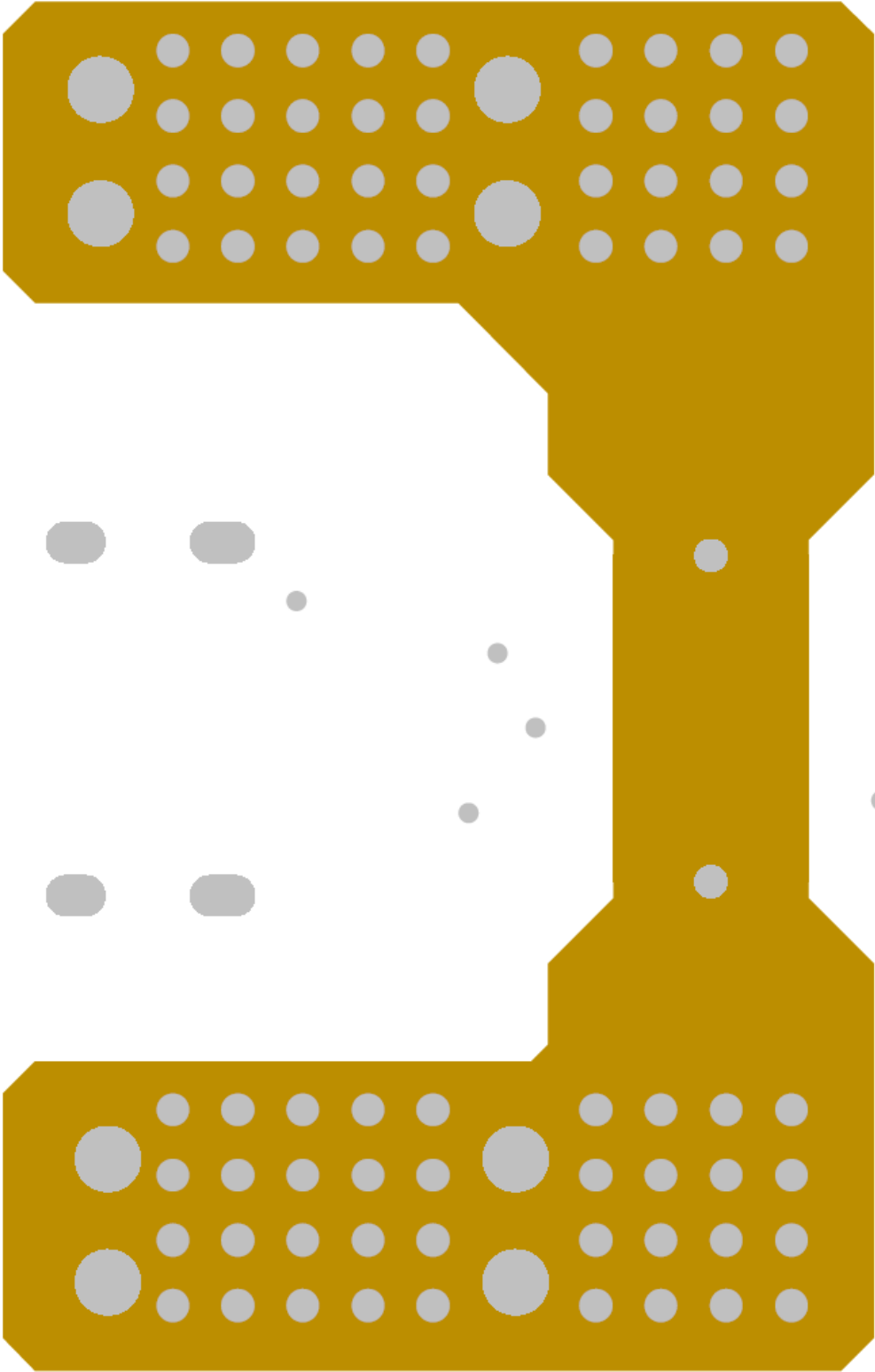

Figure 6: Middle Layer



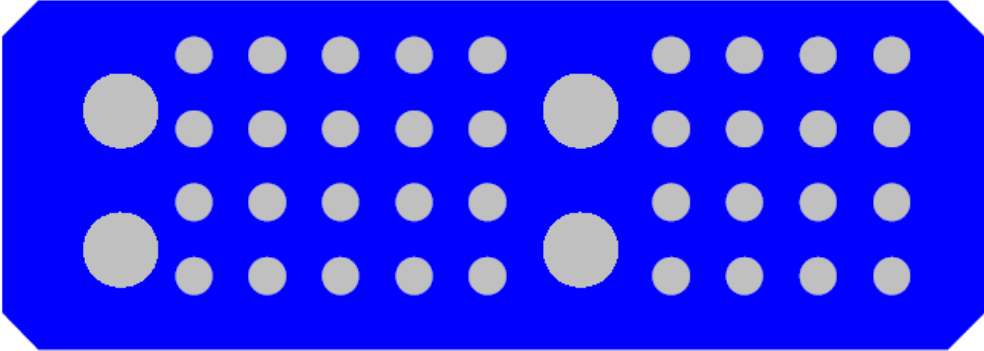
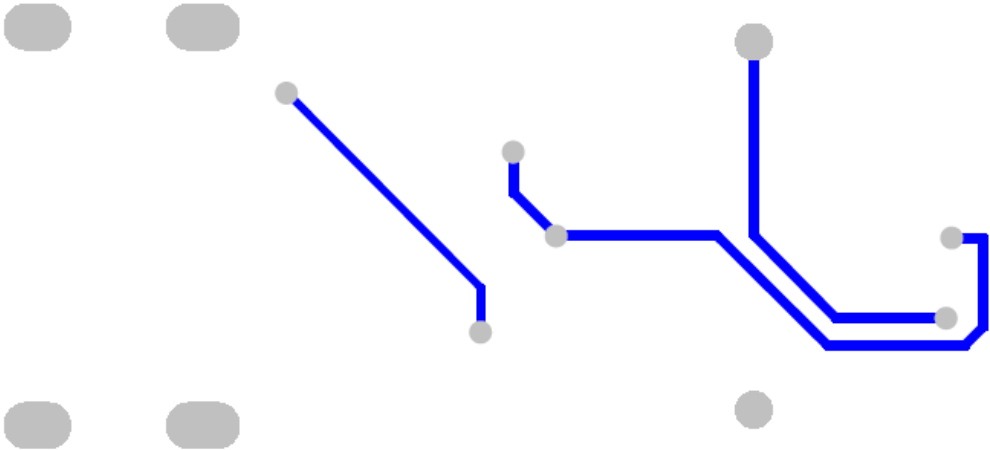
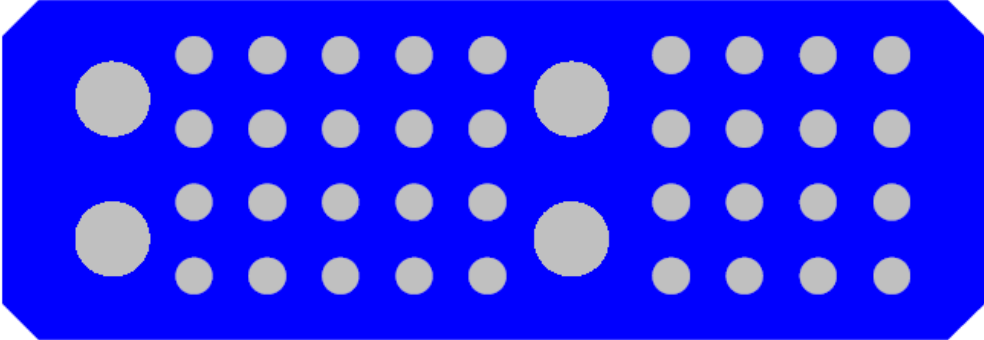

Figure 7: Bottom Layer

Bill of Materials		Copper-Shunt-mini							
Company:		ams AG							
Originator:		gheh							
PCB Name:		Copper-Shunt-mini							
PCB Version:		0.1							
Report Date:		28.11.2013							
#	Designator	Comment	Name Error-Component	Manufacturer	Manufacturer Part Number	Supplier 1	Supplier Part Number 1	Quantity	
1	C1	100nF		REMET	C0603C104K5RAC1U	Farnell	1288255	1	
2	C2	220nF		MULTICOMP	MCCA000162	Farnell	1759019	1	
3	C3	100nF		REMET	C0603C104K5RAC1U	Farnell	1288255	1	
4	C4	10uF		MURATA	GRMB1CF61H106KA12L	Farnell	1845762	1	
5	GND	PLH 16/1-10						1	
6	LOAD	PLH 16/1-10						1	
7	ST	HDM mini rcpt		MULTICOMP	60U019S-340N-81-FEC	Farnell	1708474	1	
8	SH1	SHUNT_COPPER						1	
9	UT	AS8510				AMS	AS8510-ASSM	1	
Approved			Notes					9	

Table 1: BOM

## 6 Ordering Information

The AS8510 Copper Shunt demo can be ordered via:

Table 2: Ordering Information

Ordering Code	Productname	Materialnumber
AS8510-COPPER-SHUNT	AS8510-Copper-Shunt Mini Board	00000000990600783

### Copyright

Copyright © 1997-2014, ams AG, Tobelbader Straße 30, 8141 Unterpremstaetten, Austria-Europe. Trademarks Registered ®. All rights reserved. The material herein may not be reproduced, adapted, merged, translated, stored, or used without the prior written consent of the copyright owner.

All products and companies mentioned are trademarks or registered trademarks of their respective companies.