

**Note:** All part numbers are RoHS Compliant.

---

## Table of Contents—Interface Module Systems

---

|  |          |
|--|----------|
| Overview (Catalog Numbering Code) .....  | 196      |
| <b>Interface Modules</b> .....           | 197-204  |
| DIN 41612 Connector .....                | 198      |
| Telco Connector .....                    | 199      |
| D-Sub Connector .....                    | 200      |
| Flat Cable Connector .....               | 201      |
| DIP and ZIF Sockets .....                | 202      |
| Card Edge Modules .....                  | 203, 204 |
| <b>Sockets</b> .....                     |          |
| 8 Pin Octal Socket Assemblies .....      | 205      |
| 11 Pin Socket Assemblies .....           | 206      |
| 16 Pin Miniature Socket Assemblies ..... | 207      |
| 14 Pin Miniature Socket Assemblies ..... | 208      |
| 11 Pin Square Socket Assemblies .....    | 209      |
| Individual Sockets .....                 | 210      |
| SNAPTRACK Channel .....                  | 211      |
| Accessories .....                        | 212      |

**Note:** All part numbers are RoHS Compliant.

**Catalog Numbering Code**



**NOTE:** Some catalog number combinations are not valid. Check appropriate catalog pages before ordering.

**Note:** All part numbers are RoHS Compliant.

## Interface Modules

### Product Facts

- n Catalog designs for many industry connectors:
  - n DIN 41612 Connector
  - n Telco Connector
  - n D-Sub Connector
  - n Flat Cable Connector (daisy chain possible)
  - n DIP & ZIF Sockets
  - n Card Edge Modules
- n Mounts on SNAPTRACK Channel which can be panel mounted or snapped to a DIN rail.
- n Terminal Block screws supplied in ready-to-wire position to save installation time.



These Modules convert industry specific connectors to field wiring and are designed to supply custom solutions.

**Note:** All part numbers are RoHS Compliant.

**DIN 41612 Connector**



**Material & Finish**

**Connector:**

**Housing Material**—Thermoplastic polyester.

**Flammability**—UL94V-0

**Terminals**—Copper alloy, selective gold over nickel

**Terminal Block:**

**Housing Material**—Thermoplastic polyester

**Flammability**—UL94V-0

**Color**—Black

**Max. Operating Temperature**—120°C [248°]

**Terminals**—Bright acid-tin over copper alloy

**Screws**—#3-48, steel zinc plated

**Wire Range**—12-22 AWG

**Mounting**—2TK2 and 2TK2D Series SNAPTRACK Channel



**2M64DIN-C**

**2M64DIN**



| Description   | DIN Connector Mates With | Non RoHS Compliant |                |
|---|--------------------------|--------------------|----------------|
|   |                          | Part Number        | Catalog Number |
| 64 Position reverse male DIN (Type R), A and C filled | Type Q                   | 3-1437684-4        | 2M64DIN        |
| 64 Position male DIN (Type C), A and C filled         | Type B                   | 3-1437684-5        | 2M64DIN-C      |

| Description   | DIN Connector Mates With | RoHS Compliant |                |
|---|--------------------------|----------------|----------------|
|   |                          | Part Number    | Catalog Number |
| 64 Position reverse male DIN (Type R), A and C filled | Type Q                   | 1776645-1      | 2M64DINL       |
| 64 Position male DIN (Type C), A and C filled         | Type B                   | 1776646-1      | 2M64DIN-CL     |

**Telco Connector**



**Material & Finish**

**Connector:**

**Housing Material**—Thermoplastic polyester

**Flammability**—UL94V-0

**Terminals**—Copper alloy, selective gold over nickel

**Application Data**—2M50TELS(P)  
Complies with SCSI Connections

**Terminal Block:**

**Housing Material**—Thermoplastic polyester

**Flammability**—UL94V-0

**Color**—Black

**Max. Operating Temperature**—120°C [248°]

**Terminals**—Bright acid-tin over copper alloy

**Screws**—#3-48, steel zinc plated

**Wire Range**—12-22 AWG

**Mounting**—2TK2 and 2TK2D Series SNAPTRACK Channel

| No. of Positions | Dim. C       | Non RoHS Compliant |                |             |                |
|------------------|--------------|--------------------|----------------|-------------|----------------|
|                  |              | Socket             |                | Plug        |                |
|                  |              | Part Number        | Catalog Number | Part Number | Catalog Number |
| 36               | 4.30 (109.2) | 2-1437684-1        | 2M36TELS       | —           | 2M36TELP       |
| 50               | 5.70 (144.8) | 3-1437684-2        | 2M50TELS       | 3-1437684-1 | 2M50TELP       |

| No. of Positions | Dim. C       | RoHS Compliant |                |             |                |
|------------------|--------------|----------------|----------------|-------------|----------------|
|                  |              | Socket         |                | Plug        |                |
|                  |              | Part Number    | Catalog Number | Part Number | Catalog Number |
| 36               | 4.30 (109.2) | 1776826-1      | 2M36TELSL      | —           | 2M36TELPL      |
| 50               | 5.70 (144.8) | 1776604-1      | 2M50TELSL      | 1776643-1   | 2M50TELPL      |

## D-Sub Connector



### Material & Finish

#### Connector:

**Housing Material**—Thermoplastic polyester.

**Flammability**—UL94V-0

**Terminals**—Copper alloy, selective gold over nickel

**Shell Material**—Bright tin plated, female screw locks installed

#### Terminal Block:

**Housing Material**—Thermoplastic polyester

**Flammability**—UL94V-0

**Color**—Black

**Max. Operating Temperature**—120°C [248°]

**Terminals**—Bright acid-tin over copper alloy

**Screws**—#3-48, steel zinc plated

**Wire Range**—12-22 AWG

**Mounting**—2TK2 and 2TK2D Series SNAPTRACK Channel



| No. of Positions | Dim. C       | Non RoHS Compliant |                |
|------------------|--------------|--------------------|----------------|
|                  |              | Part Number        | Catalog Number |
| 09               | 1.50 (38.1)  | 1437684-3          | 2M09DSM        |
| 15               | 2.10 (53.3)  | 1437684-7          | 2M15DSM        |
| 25               | 3.10 (78.7)  | 1-1437684-8        | 2M25DSM        |
| 37               | 4.31 (109.5) | 2-1437684-3        | 2M37DSM        |
| 50               | 5.93 (150.6) | 2-1437684-9        | 2M50DSM        |

**Note:** Female D-Sub connector available as 2MxxDSF. Consult Technical Support Center.

| No. of Positions | Dim. C       | RoHS Compliant |                |
|------------------|--------------|----------------|----------------|
|                  |              | Part Number    | Catalog Number |
| 09               | 1.50 (38.1)  | 1546693-1      | 2M09DSML       |
| 15               | 2.10 (53.3)  | 1546694-1      | 2M15DSML       |
| 25               | 3.10 (78.7)  | 1776224-1      | 2M25DSML       |
| 37               | 4.31 (109.5) | 1776612-1      | 2M37DSML       |
| 50               | 5.93 (150.6) | 1776613-1      | 2M50DSML       |

**Note:** Female D-Sub connector available as 2MxxDSFL. Consult Technical Support Center.

**Note:** All part numbers are RoHS Compliant.

## Flat Cable Connector

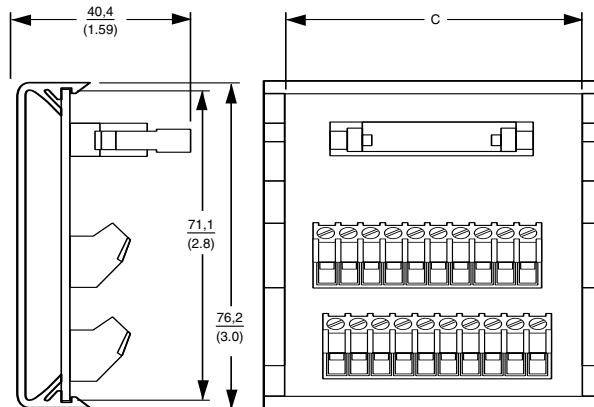

### Material & Finish

#### Connector:

**Header**—Brass, gold over nickel, UL94V-0 thermoplastic

**Connector**—Copper alloy; gold over nickel 94V-0 thermoplastic

**Wire Range**—26-30 AWG solid, 28 AWG stranded

**Maximum Current**—1 Ampere

#### Terminal Block:

**Housing Material**—Thermoplastic polyester

**Flammability**—UL94V-0

**Color**—Black

**Max. Operating Temperature**—120°C [248°]

**Terminals**—Bright acid-tin over copper alloy

**Screws**—#3-48, steel zinc plated

**Wire Range**—12-22 AWG

**Mounting**—2TK2 and 2TK2D Series SNAPTRACK Channel

| No. of Positions | Dim. C       | Non RoHS Compliant |                | RoHS Compliant |                |
|------------------|--------------|--------------------|----------------|----------------|----------------|
|                  |              | Part Number        | Catalog Number | Part Number    | Catalog Number |
| 10               | 38.1 (1.50)  | 1437684-5          | 2M10FC         | 1776615-1      | 2M10FCL        |
| 14               | 53.3 (2.10)  | 1437684-6          | 2M14FC         | 1776616-1      | 2M14FCL        |
| 16               | 58.4 (2.30)  | 1-1437684-1        | 2M16FC         | 1776625-1      | 2M15FCL        |
| 20               | 68.6 (2.70)  | 1-1437684-2        | 2M20FC         | 1776626-1      | 2M20FCL        |
| 26               | 81.3 (3.20)  | 1-1437684-9        | 2M26FC         | 1776630-1      | 2M26FCL        |
| 34               | 104.1 (4.10) | 2-1437684-0        | 2M34FC         | 1776638-1      | 2M34FCL        |
| 40               | 119.4 (4.70) | 2-1437684-6        | 2M40FC         | 1776640-1      | 2M40FCL        |
| 50               | 139.7 (5.50) | 3-1437684-0        | 2M50FC         | 1776642-1      | 2M50FCL        |
| 60               | 165.1 (6.50) | 3-1437684-3        | 2M60FC         | 1776644-1      | 2M60FCL        |
| 64               | 170.2 (6.70) | 3-1437684-6        | 2M64FC         | 1776647-1      | 2M64FCL        |

**Note:** Strain relief connector supplied with all assemblies.

**Note:** All part numbers are RoHS Compliant.

**DIP and ZIF Sockets**



**Material & Finish**

**Connector:**

**Terminal**—Contacts copper alloy, gold over nickel

**Terminal Block:**

**Housing Material**—Thermoplastic polyester

**Flammability**—UL94V-0

**Color**—Black

**Max. Operating Temperature**—120°C [248°]

**Terminals**—Bright acid-tin over copper alloy

**Screws**—#3-48, steel zinc plated

**Wire Range**—12-22 AWG

**Mounting**—2TK2 and 2TK2D Series SNAPTRACK Channel

**2M16DP**

**2M16DPZ**



| No. of Positions                    | Socket Pin Spacing Grid Size Dimensions |              |                             | Non RoHS Compliant |                |
|-------------------------------------|---|--------------|-----------------------------|--------------------|----------------|
|                                     | B                                       | C            | D                           | Part Number        | Catalog Number |
| <b>DIP Socket to Screw Terminal</b> |   |              |                             |                    |                |
| 8                                   | 1.05 (26.7)                             | 1.20 (30.5)  | .100 x .300<br>(2.5 x 7.6)  | 1437684-2          | 2M08DP         |
| 16                                  | 1.05 (26.7)                             | 2.00 (50.8)  | .100 x .300<br>(2.5 x 7.6)  | 1437684-8          | 2M16DP         |
| 24                                  | 1.05 (26.7)                             | 2.80 (71.1)  | .100 x .600<br>(2.5 x 15.2) | 1-1437684-4        | 2M24DP         |
| 40                                  | 1.05 (26.7)                             | 4.40 (111.8) | .100 x .600<br>(2.5 x 15.2) | 2-1437684-4        | 2M40DP         |
| <b>ZIF Socket to Screw Terminal</b> |   |              |                             |                    |                |
| 16                                  | 1.40 (35.6)                             | 2.00 (50.8)  | —                           | 1-1437684-0        | 2M16DPZ        |
| 24                                  | 1.40 (35.6)                             | 2.80 (71.1)  | —                           | 1-1437684-5        | 2M24DPZ        |
| 40                                  | 1.40 (35.6)                             | 4.40 (111.8) | —                           | 2-1437684-5        | 2M40DPZ        |

**Note:** ZIF denotes zero insertion force.

| No. of Positions                    | Socket Pin Spacing Grid Size Dimensions |              |                             | RoHS Compliant |                |
|-------------------------------------|---|--------------|-----------------------------|----------------|----------------|
|                                     | B                                       | C            | D                           | Part Number    | Catalog Number |
| <b>DIP Socket to Screw Terminal</b> |   |              |                             |                |                |
| 8                                   | 1.05 (26.7)                             | 1.20 (30.5)  | .100 x .300<br>(2.5 x 7.6)  | 1776599-1      | 2M08DPL        |
| 16                                  | 1.05 (26.7)                             | 2.00 (50.8)  | .100 x .300<br>(2.5 x 7.6)  | 1776600-1      | 2M16DPL        |
| 24                                  | 1.05 (26.7)                             | 2.80 (71.1)  | .100 x .600<br>(2.5 x 15.2) | 1776602-1      | 2M24DPL        |
| 40                                  | 1.05 (26.7)                             | 4.40 (111.8) | .100 x .600<br>(2.5 x 15.2) | 1776603-1      | 2M40DPL        |
| <b>ZIF Socket to Screw Terminal</b> |   |              |                             |                |                |
| 16                                  | 1.40 (35.6)                             | 2.00 (50.8)  | —                           | 1776624-1      | 2M16DPZL       |
| 24                                  | 1.40 (35.6)                             | 2.80 (71.1)  | —                           | 1776628-1      | 2M24DPZL       |
| 40                                  | 1.40 (35.6)                             | 4.40 (111.8) | —                           | 1776639-1      | 2M40DPZL       |

**Note:** ZIF denotes zero insertion force.



## Card Edge Modules



### Material & Finish

**Connector**—Gold over nickel contact with card guide—accepts up to 4.5" [114.30] wide board. 0.156" [3.96] pitch (terminal spacing)

### 22PCB, 44PC

#### Terminal Block Tri-Barrier

**Terminals**—Bright acid tin over copper alloy

**Screws**—#4-40 steel zinc with clear chromate with captive wire clamping plate

**Wire Range**—14-22 AWG

**Mounting**—Fits TK2 & TK2D Series

### 2M22PCB, 2M44PC

#### Terminal Block:

**Housing Material**—Thermoplastic polyester

**Flammability**—UL94V-0

**Color**—Black

**Max. Operating Temperature**—120°C [248°]

**Terminals**—Bright acid-tin over copper alloy

**Screws**—#3-48, steel zinc plated

**Wire Range**—12-22 AWG

**Mounting**—2TK2 and 2TK2D Series SNAPTRACK Channel

| Description  | Non RoHS Compliant |                |
|--|--------------------|----------------|
|  | Part Number        | Catalog Number |
| For single-sided notched cards. Numbered Terminals 1-22 and A-Z        | 1437684-1          | 22PCB          |
| For double-sided, notched cards. Numbered terminals A-Z, 1-22 and 1-44 | 3-1437684-7        | 44PC           |
| Similar to 22PCB but all terminal positions are on one side of board   | 1-1437684-3        | 2M22PCB        |
| Similar to 44PC but all terminal positions are on one side of board    | 2-1437684-7        | 2M44PC         |

| Description  | RoHS Compliant |                |
|--|----------------|----------------|
|  | Part Number    | Catalog Number |
| For single-sided notched cards. Numbered Terminals 1-22 and A-Z        | 1776614-1      | 22PCBL         |
| For double-sided, notched cards. Numbered terminals A-Z, 1-22 and 1-44 | 1776649-1      | 44PCL          |
| Similar to 22PCBL but all terminal positions are on one side of board  | 1776627-1      | 2M22PCBL       |
| Similar to 44PCL but all terminal positions are on one side of board   | 1776641-1      | 2M44PCL        |

**Note:** All part numbers are RoHS Compliant.

**Card Edge Modules (Continued)**

**2M22PCB and 2M44PC**



**22PCB and 44PC**

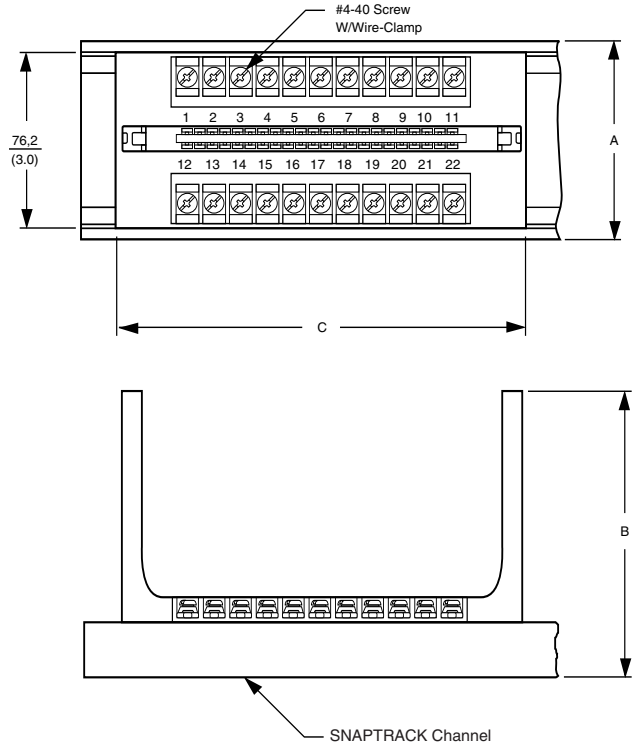

| No. of Positions | Track Size | Dimensions  |             |              |               | Non RoHS Compliant |                |
|------------------|------------|-------------|-------------|--------------|---------------|--------------------|----------------|
|                  |            | A Ref.      | B           | C            | PC Card Width | Part Number        | Catalog Number |
| 22               | TK(2D)     | 80.3 (3.16) | 90.4 (3.56) | 127.0 (5.00) | 114.3 (4.5)   | 1437684-1          | 22PCB          |
|                  | 2TK(2D)    | 69.9 (2.75) | 90.4 (3.56) | 127.0 (5.00) | 114.3 (4.5)   | 1-1437684-3        | 2M22PCB        |
| 44               | TK (2D)    | 80.3 (3.16) | 90.4 (3.56) | 190.5 (7.50) | 114.3 (4.5)   | 3-1437684-7        | 44PC           |
|                  | 2TK(2D)    | 69.9 (2.75) | 90.4 (3.56) | 127.0 (5.00) | 114.3 (4.5)   | 2-1437684-7        | 2M44PC         |

| No. of Positions | Track Size | Dimensions  |             |              |               | RoHS Compliant |                |
|------------------|------------|-------------|-------------|--------------|---------------|----------------|----------------|
|                  |            | A Ref.      | B           | C            | PC Card Width | Part Number    | Catalog Number |
| 22               | TK(2D)     | 80.3 (3.16) | 90.4 (3.56) | 127.0 (5.00) | 114.3 (4.5)   | 1776614-1      | 22PCBL         |
|                  | 2TK(2D)    | 69.9 (2.75) | 90.4 (3.56) | 127.0 (5.00) | 114.3 (4.5)   | 1776627-1      | 2M22PCBL       |
| 44               | TK (2D)    | 80.3 (3.16) | 90.4 (3.56) | 190.5 (7.50) | 114.3 (4.5)   | 1776649-1      | 44PCL          |
|                  | 2TK(2D)    | 69.9 (2.75) | 90.4 (3.56) | 127.0 (5.00) | 114.3 (4.5)   | 1776641-1      | 2M44PCL        |

**Note:** All part numbers are RoHS Compliant.

## 8 Pin Octal Socket Assemblies

### SM8 and 608BR



### 318BR, 208BR, 608BR, 218BR



### Material & Finish

#### 208BR, 218BR, 318BR

- Rating**—10A, 150V
- Screws**—#4-40 zinc plated with clear chromate, with wire clamp
- Wire Range**—4-22 AWG
- Bails**—RB1, TB1(see accessory page 212)

#### 608BR

- Rating**—10A, 250V
- Screws**—#6-32 zinc plated with wire clamp
- Wire Range**—12-22 AWG
- Bails**—RB1, TB1(see accessory page 212)

#### SM8

- Rating**—10A, 300V
- Material**—ABS
- Flammability**—UL94V-0
- Contacts**—Tin over copper-plated phosphor-bronze.
- Screws**—#6-32 zinc plated with clear chromate with wire clamping plates
- Wire Range**—12-22 AWG
- Max. Operating Temperature**—60°C [140°F]

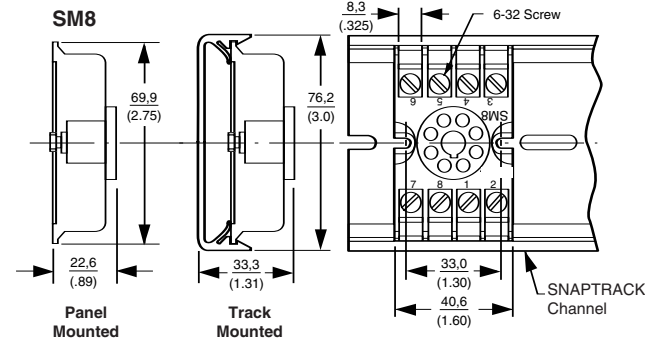

| Dimensions  |             |             |             | Non RoHS Compliant |                | RoHS Compliant     |
|-------------|-------------|-------------|-------------|--------------------|----------------|--------------------|
| A           | B           | C           | D           | Part Number        | Catalog Number | SNAPTRACK® Channel |
| 3.16 (80.3) | 1.13 (28.7) | 2.00 (50.8) | 1.69 (42.9) | 1437683-6          | 208BR          | TK2(D)             |
| 3.16 (80.3) | 1.13 (28.7) | 1.50 (38.1) | —           | 1-1437683-0        | 218BR          | TK2(D)             |
| 2.90 (73.7) | 1.13 (28.7) | 1.50 (38.1) | —           | 1-1437683-4        | 318BR          | 2TK2(D)            |
| 3.16 (80.3) | 1.13 (28.7) | 2.00 (50.8) | 1.69 (42.9) | 1-1437683-6        | 608BR          | TK2(D)             |
| —           | —           | —           | —           | 2-1437683-8        | SM8            | 2TK2               |

**Note:** SM8 is a molded product with mounting holes provided.

### Related Product Data

Sockets on this page will fit the following relays:

- Tyco Electronics Relay Series**—SCB, SCC, SCE, SRC, SSC, SST, VMA
- P&B Relay Series**—CB, CD, CG, CH, CK, CR, CN1, CNS, CS, KRP/KRPA, S89R\_P, 155
- SCHRACK Relay Series**—MT

For more information on Relays request Catalog 1308242.

| Dimensions  |             |             |             | RoHS Compliant |                |                    |
|-------------|-------------|-------------|-------------|----------------|----------------|--------------------|
| A           | B           | C           | D           | Part Number    | Catalog Number | SNAPTRACK® Channel |
| 3.16 (80.3) | 1.13 (28.7) | 2.00 (50.8) | 1.69 (42.9) | 1776633-1      | 208BRL         | TK2(D)             |
| 3.16 (80.3) | 1.13 (28.7) | 1.50 (38.1) | —           | 1776617-1      | 218BRL         | TK2(D)             |
| 2.90 (73.7) | 1.13 (28.7) | 1.50 (38.1) | —           | 1776619-1      | 318BRL         | 2TK2(D)            |
| 3.16 (80.3) | 1.13 (28.7) | 2.00 (50.8) | 1.69 (42.9) | 1776620-1      | 608BRL         | TK2(D)             |
| —           | —           | —           | —           | 2-1437683-8    | SM8            | 2TK2               |

**Note:** SM8 is a molded product with mounting holes provided.

**Note:** All part numbers are RoHS Compliant.

**11 Pin Socket Assemblies**

**SM11 and 611BR**



**Material & Finish**

**211BR, 311BR**

**Rating**—10A, 150V  
**Screws**—#4-40 zinc plated with clear chromate with wire clamps  
**Wire Range**—14-22 AWG  
**Bails**—RB1, TB1 (see accessory page 212)

**611BR**

**Rating**—10A, 250V  
**Screws**—#6-32 zinc plated with clear chromate, with wire clamps.  
**Wire Range**—12-22 AWG  
**Bails**—RB1, TB1 (see accessory page 212)



**SM11**

**Rating**—10A, 300V  
**Material**—ABS  
**Flammability**—UL94V-0  
**Max. Operating Temperature**—60°C [140°F]  
**Contacts**—Tin over copper-plated phosphor-bronze.  
**Screws**—#6-32 zinc plated with clear chromate, with wire clamps  
**Wire Range**—12-22 AWG  
**Bails**—RB5 (see accessory page 212)

| Dimensions  |             |             |             | Non RoHS Compliant |                | RoHS Compliant     |
|-------------|-------------|-------------|-------------|--------------------|----------------|--------------------|
| A           | B           | C           | D           | Part Number        | Catalog Number | SNAPTRACK® Channel |
| 3.16 (80.3) | 1.13 (28.7) | 2.13 (54.1) | 1.18 (46.0) | 1437683-7          | 211BR          | TK2(D)             |
| 2.90 (73.7) | 1.13 (28.7) | 2.13 (54.1) | 1.18 (46.0) | 1-1437683-2        | 311BR          | 2TK2(D)            |
| 3.16 (80.3) | 1.13 (28.7) | 2.75 (69.9) | 2.30 (60.5) | 1-1437683-8        | 611BR          | TK2(D)             |
| —           | —           | —           | —           | 2-1437683-7        | SM11           | 2TK                |

**Note:** SM11 is a molded product with mounting holes provided.

**Related Product Data**

Sockets on this page will fit the following relays:

- Tyco Electronics Relay Series**—SCF, SSC, SCB, SCC, SST
- P&B Relay Series**—CB, CD, CG, CH, CK, CNM5, CNS, CNT, KBP, KRP/KRPA, 155
- SCHRACK Relay Series**—MT

For more information on Relays request Catalog 1308242.

| Dimensions  |             |             |             | RoHS Compliant |                |                    |
|-------------|-------------|-------------|-------------|----------------|----------------|--------------------|
| A           | B           | C           | D           | Part Number    | Catalog Number | SNAPTRACK® Channel |
| 3.16 (80.3) | 1.13 (28.7) | 2.13 (54.1) | 1.18 (46.0) | 1776634-1      | 211BRL         | TK2(D)             |
| 2.90 (73.7) | 1.13 (28.7) | 2.13 (54.1) | 1.18 (46.0) | 1776827-1      | 311BRL         | 2TK2(D)            |
| 3.16 (80.3) | 1.13 (28.7) | 2.75 (69.9) | 2.30 (60.5) | 1776622-1      | 611BRL         | TK2(D)             |
| —           | —           | —           | —           | 2-1437683-7    | SM11           | 2TK                |

**Note:** SM11 is a molded product with mounting holes provided.



**Note:** All part numbers are RoHS Compliant.

**16 Pin Miniature Socket Assemblies**

**204BS**

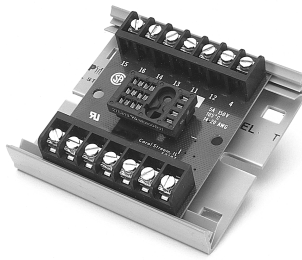

**Material & Finish**

**Rating**—5A,150V

**Max. Operating Temperature**—105°C

**Screws**—#4-40 zinc plated with captive wire clamping plate

**Wire Range**—14-22 AWG

**Bails**—204BS-RB4 (see accessory page 212)

**Related Product Data**

Sockets on this page will fit the following relays:

**P&B Relay Series**—R10

For more information on Relays request Catalog 1308242.



| Dimensions  |             |             |             | Fits Relay | Non RoHS Compliant |                | RoHS Compliant     |
|-------------|-------------|-------------|-------------|------------|--------------------|----------------|--------------------|
| A           | B           | C           | D           |            | Part Number        | Catalog Number | SNAPTRACK® Channel |
| 3.16 (80.3) | 1.00 (25.4) | 1.50 (38.1) | —           | 2PDT       | 1437683-4          | 202BS          | TK2(D)             |
| 3.16 (80.3) | 1.00 (25.4) | 2.50 (63.5) | 2.13 (54.1) | 4PDT       | 1437683-5          | 204BS          | TK2                |

**Note:** Holes provided for bails, see page 212.

| Dimensions  |             |             |             | Fits Relay | RoHS Compliant |                |                    |
|-------------|-------------|-------------|-------------|------------|----------------|----------------|--------------------|
| A           | B           | C           | D           |            | Part Number    | Catalog Number | SNAPTRACK® Channel |
| 3.16 (80.3) | 1.00 (25.4) | 1.50 (38.1) | —           | 2PDT       | 1776631-1      | 202BSL         | TK2(D)             |
| 3.16 (80.3) | 1.00 (25.4) | 2.50 (63.5) | 2.13 (54.1) | 4PDT       | 1776632-1      | 204BSL         | TK2                |

**Note:** Holes provided for bails, see page 212.

**Note:** All part numbers are RoHS Compliant.

## 14 Pin Miniature Socket Assemblies

### 214BS



#### Material & Finish

**Ratings**—5A,150V

#### 214BS, 314BS

**Screws**—#4-40 zinc plated with clear chromate, with captive wire clamping plate

**Wire Range**—14-22 AWG

#### 614BS

**Screws**—#6-32 zinc plated with clear chromate, with wire clamp

**Wire Range**—12-22 AWG

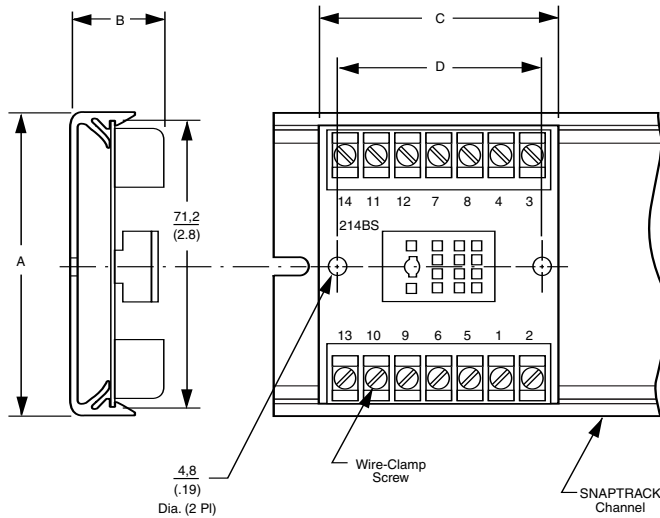

#### Related Product Data

Sockets on this page will fit the following relays:

**P&B Relay Series**—KHAU/KHU, 156, 158

**SCHRACK Relay Series**—PT

For more information on Relays request Catalog 1308242.

| Dimensions  |             |             |             | Fits Relay | Non RoHS Compliant |                | RoHS Compliant     |
|-------------|-------------|-------------|-------------|------------|--------------------|----------------|--------------------|
| A           | B           | C           | D           |            | Part Number        | Catalog Number | SNAPTRACK® Channel |
| 3.16 (80.3) | 1.06 (26.9) | 2.50 (63.5) | 2.13 (54.0) | 4PDT       | 1437683-9          | 214BS          | TK2(D)             |
| 2.90 (73.7) | 1.06 (26.9) | 2.50 (63.5) | —           | 4PDT       | 1-1437683-3        | 314BS          | 2TK2(D)            |
| 3.16 (80.3) | 1.13 (28.7) | 2.75 (69.9) | —           | 4PDT       | 2-1437683-0        | 614BS          | TK2(D)             |

**Note:** Holes provided for bails, see page 212.

| Dimensions  |             |             |             | Fits Relay | RoHS Compliant |                |                    |
|-------------|-------------|-------------|-------------|------------|----------------|----------------|--------------------|
| A           | B           | C           | D           |            | Part Number    | Catalog Number | SNAPTRACK® Channel |
| 3.16 (80.3) | 1.06 (26.9) | 2.50 (63.5) | 2.13 (54.0) | 4PDT       | 1776636-1      | 214BSL         | TK2(D)             |
| 2.90 (73.7) | 1.06 (26.9) | 2.50 (63.5) | —           | 4PDT       | 1776618-1      | 314BSL         | 2TK2(D)            |
| 3.16 (80.3) | 1.13 (28.7) | 2.75 (69.9) | —           | 4PDT       | 1776637-1      | 614BSL         | TK2(D)             |

**Note:** Holes provided for bails, see page 212.



**Note:** All part numbers are RoHS Compliant.

## 11 Pin Square Socket Assemblies

### 608BS

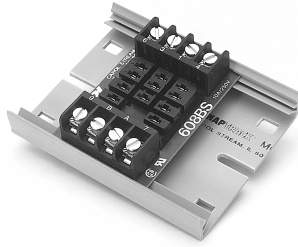

#### Material & Finish

#### 608BS, 611BS

**Rating**—10A, 250V

**Screws**—#6-32 zinc plated with clear chromate, with wire clamp

**Wire Range**—12-22 AWG

#### 211BS

**Rating**—10A, 150V

**Screws**—#4-40 zinc plated with clear chromate, with wire clamp

**Wire Range**—14-22 AWG

#### Related Product Data

Sockets on this page will fit the following relays:

**Tyco Electronics Relay Series**—STA

**P&B Relay Series**—CL, CU, KUPE, KUIP, KUMP, KUGP, KUL, KUP, SDAS-01, 157

**SCHRACK Relay Series**—RM2/3/7, RM5/6

For more information on Relays request Catalog 1308242.

| Dimensions  |             |             | Fits Relay | Non RoHS Compliant |                | RoHS Compliant     |
|-------------|-------------|-------------|------------|--------------------|----------------|--------------------|
| A           | B           | C           |            | Part Number        | Catalog Number | SNAPTRACK® Channel |
| 3.16 (80.3) | 1.06 (26.9) | 2.13 (54.1) | SPDT, DPDT | 1437683-8          | 211BS          | TK2(D)             |
| 3.16 (80.3) | 1.13 (28.7) | 2.00 (50.8) | 3PDT       | 1-1437683-7        | 608BS          | TK2(D)             |
| 3.16 (80.3) | 1.13 (28.7) | 2.50 (63.5) | DPDT, 3PDT | 1-1437683-9        | 611BS          | TK2(D)             |

| Dimensions  |             |             | Fits Relay | RoHS Compliant |                |                    |
|-------------|-------------|-------------|------------|----------------|----------------|--------------------|
| A           | B           | C           |            | Part Number    | Catalog Number | SNAPTRACK® Channel |
| 3.16 (80.3) | 1.06 (26.9) | 2.13 (54.1) | SPDT, DPDT | 1776630-1      | 211BSL         | TK2(D)             |
| 3.16 (80.3) | 1.13 (28.7) | 2.00 (50.8) | 3PDT       | 1776621-1      | 608BSL         | TK2(D)             |
| 3.16 (80.3) | 1.13 (28.7) | 2.50 (63.5) | DPDT, 3PDT | 1776623-1      | 611BSL         | TK2(D)             |

211BS ONLY



LR49571



E58648

**Note:** All part numbers are RoHS Compliant.

## Individual Sockets

### Material & Finish

- Ratings**—10A/300V
- Housing Material**—Thermoplastic polyester
- Flammability**—UL94V-0
- Color**—Black
- Max. Operating Temperature**—130°C [266°F]
- Contacts**—Phosphor-bronze, bright acid-tin plated

### Related Product Data

Sockets 8S and 11S will fit the following relays:

- AGASTAT Relay Series**—STA
- P&B/MIDTEX Relay Series**—CL, CU, KUJEP, KUIP, KUMP, KUGP, KUL, KUP, SDAS-01, 157
- SCHRACK Relay Series**—RM2/3/7, RM5/6

Socket 21S will fit the following relays:

- P&B Relay Series**—R10
- Socket 14S will fit the following relays:
- P&B/MIDTEX Relay Series**—KHAU/KHU, 156, 158
- SCHRACK Relay Series**—PT

- Socket 8R will fit the following relays:
- AGASTAT Relay Series**—SCB, SCC, SCE, SRC, SSC, SST, VMA
- P&B/MIDTEX Relay Series**—CB, CD, CG, CH, CK, CR, CN1, CNS, CS, KRP/KRPA, S89R\_\_P, 155
- SCHRACK Relay Series**—MT

Socket 11R will fit the following relays:

- Tyco Electronics Relay Series**—SCF, SSC, SCB, SCC, SST
- P&B Relay Series**—CB, CD, CG, CH, CK, CNM5, CNS, CNT, KBP, KRP/KRPA, 155
- SCHRACK Relay Series**—MT

For more information on Relays request Catalog 1308242.

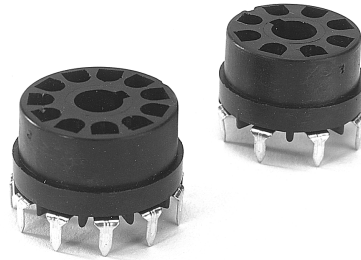

11R, 8R

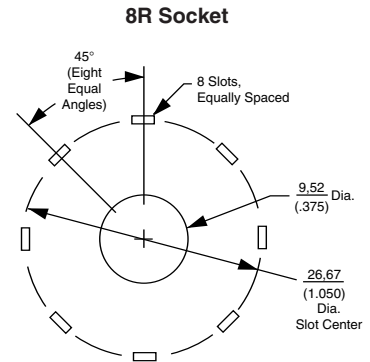

8R Socket

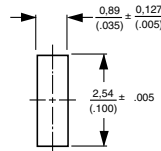



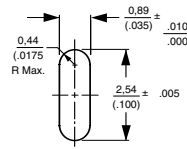

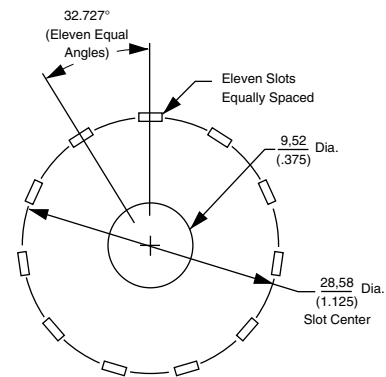

Punched Slot Detail



Routed Slot Detail



11R Socket

| Socket Style  | Fits Relays | Part Number | Catalog Number |
|---|-------------|-------------|----------------|
|  | 2PDT        | 2-1437683-2 | 8S-SOCKET      |
|  | 3PDT        | 1437661-1   | 11S-SOCKET     |
|  | 2PDT        | 1-1437683-1 | 21S-SOCKET     |
|  | 4PDT        | 1437683-3   | 14S-SOCKET     |
|  | 8 pin octal | 2-1437683-1 | 8R-SOCKET      |
|  | 11 pin      | 1437683-1   | 11R-SOCKET     |



E58648



**Note:** All part numbers are RoHS Compliant.

**SNAPTRACK Channel**

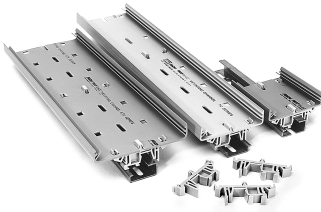

SNAPTRACK Channel can be mounted on standard DIN rails or A Series rail when used with TKAD. (Rails not included.)

SNAPTRACK Channel is a nonconductive, rigid extruded PVC chassis used for mounting socket assemblies and custom circuit boards. Available in a variety of fixed widths, including a split-apart version for wider PCB applications, SNAPTRACK Channel mounts to panels quickly with rivets or screws.

Printed circuit boards are simply snapped-in from the front, then held securely via intergral ribs which also serve as shock absorbers when the PCB is flexed. SNAPTRACK Channel permits easy, convenient PCB removal for field service. Slots on 2-inch centers are provided for fast, easy installation using either plastic rivets or other hardware. Double-faced tape may also be used effectively.

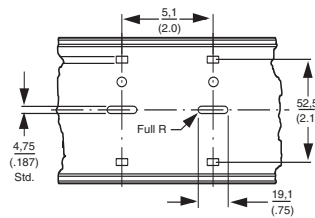

**TK2D, 2TK2D, 3TK2D, 6TK2D Panel Mount, or use with TKAD to Mount on DIN Rail and A Series Rail**

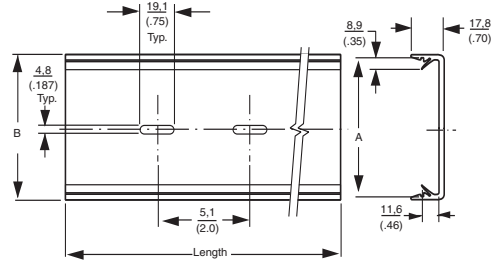

**TK2, 3TK2, 8TK2, 2TK2, 6TK2 Panel Mount**

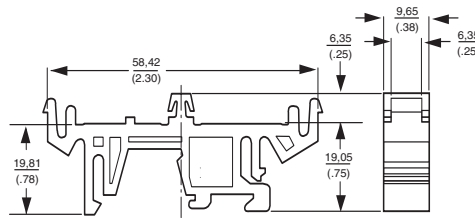

**TKAD use with SNAPTRACK Channel to Mount on DIN Rail or A Series Rail**

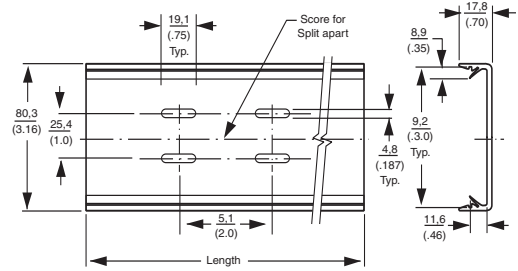

**4TK2 Panel Mount**

| Track Catalog No.* | Dimensions         |                       |
|--------------------|--------------------|-----------------------|
|                    | A P.C. Board Width | B Overall Track Width |
| 8TK2-xx            | 55.5 (2.187)       | 58.4 (2.3)            |
| 2TK2-xx            | 69.9 (2.75)        | 73.7 (2.9)            |
| 2TK2D-xx           | 69.9 (2.75)        | 73.7 (2.9)            |
| TK2-xx-AG          | 76.2 (3.0)         | 78.7 (3.1)            |
| TK2D-xx-AG         | 76.2 (3.0)         | 78.7 (3.1)            |
| 3TK2-xx            | 82.6 (3.25)        | 86.4 (3.40)           |
| 3TK2D-xx           | 82.6 (3.25)        | 86.4 (3.40)           |
| 6TK2-xx            | 101.6 (4.0)        | 105.4 (4.15)          |
| 6TK2D-xx           | 101.6 (4.0)        | 105.4 (4.15)          |
| 4TK2-xx            | SPLIT-APART        | —                     |

**Note:** Standard lengths are 3", 6", 12", 24", and 48". Custom lengths are available.

\*Replace xx with track length.

**Note:** All part numbers are RoHS Compliant.

**Accessories**

**Track Rivets**

Plastic Track Rivet offers a low cost way to mount SNAPTRACK Channel. Requires 3/16" diameter hole in panels up to .125" thick. Cat. No. TR-1



**TR-1 Track Rivet**  
1437645-6

**Bails (Tie Downs)**

Helps prevent relays and timers from vibrating out of sockets. RB1-AG and TB1, for general purpose relays and timers, feature adjustable height; mount on PC board with plastic mounting rivets (2) furnished. New economy RB5 spring bails fits most general purpose relays and timers. RB4 clip to miniature sockets. Stainless steel wire.

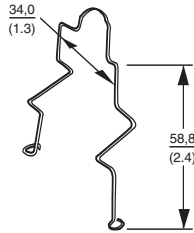

**RB1-AG Relay Bail**  
2-1437683-3

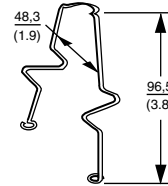

**TB1 Timer Bail**  
3-1437683-0

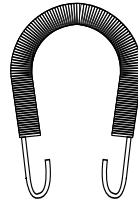

**RB5-AG Universal Bail**  
2-1437683-6

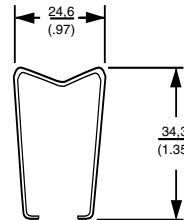

**RB4-AG**  
2-1437683-5