

Low Noise Operational Amplifiers

**BA4558F, BA4558R F/FV/FVM, BA4560F, BA4560R F/FV/FVM, BA4564RFV
BA4580R F/FVM, BA4584FV, BA4584R F/FV, BA8522R F/FV/FVM
BA15218F, BA14741F, BA15532F, BA4510F/FV, BA2115F/FVM**

No.11049EBT16

●Description

General-purpose BA4558 / BA4560 / BA15218 / BA14741 / BA15532 / BA4510 family and high-reliability BA4558R / BA4560R / BA4564R / BA4580R / BA4584 / BA4584R / BA8522R / BA2115 family integrate two or four independent Op-Amps on a single chip Especially, this series is suitable for any audio applications due to low noise and low distortion characteristics and are usable for other many applications by wide operating supply voltage range.

BA4558R / BA4560R / BA4564R / BA4580R / BA4584R / BA8522R / BA2115 are high-reliability products with extended operating temperature range and high ESD tolerance.

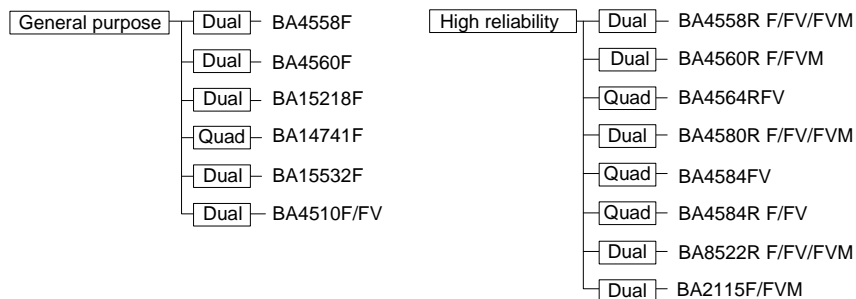

●Features

- 1) High voltage gain, low noise, low distortion
- 2) Wide operating supply voltage
 $\pm 4.0[V] \sim \pm 15.0[V]$ (split supply)
 (BA4560/BA4558/ BA4558R/BA4560R/
 BA4564R family)
 $\pm 2.0[V] \sim \pm 16.0[V]$ (split supply)
 (BA4580R/ BA4584/BA8522R/BA15218 family)
 $\pm 2.0[V] \sim \pm 8.5[V]$ (split supply)(BA4584R family)
 $\pm 2.0[V] \sim \pm 18.0[V]$ (split supply)(BA14741 family)
 $\pm 3.0[V] \sim \pm 20.0[V]$ (split supply)(BA15532 family)
 $\pm 1.0[V] \sim \pm 3.5[V]$ (split supply)(BA4510 family)
 $\pm 1.0[V] \sim \pm 7.0[V]$ (split supply)(BA2115 family)
- 3) Internal phase compensation
- 4) No latch up immunity
- 5) Internal ESD protection
 Human body mode (HBM) $\pm 5000[V]$ (Typ.)
 (BA4558R/BA4560R/BA4564R/BA4580R/BA4584/
 BA4584R/BA8522R/BA2115 family)
- 6) Wide temperature range
 $-40[^\circ C] \sim +85[^\circ C]$
 (BA4558/BA4560/BA4584/BA15218/BA14741/
 BA2115 family)
 $-40[^\circ C] \sim +105[^\circ C]$
 (BA4558R/BA4560R/BA4564R/BA4580R/BA4584R/
 BA8522R family)

●Pin Assignments

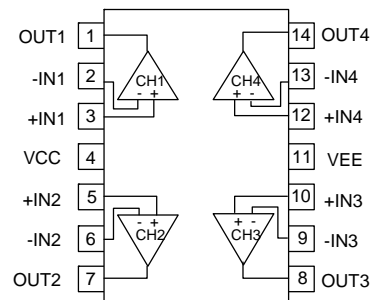
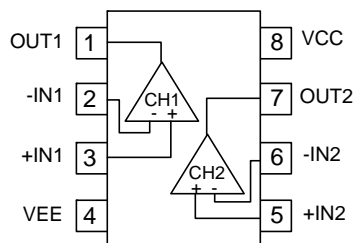

SOP8		SSOP-B8		MSOP8		SOP14		SSOP-B14	
BA4558F	BA4558RF	BA4558RFV	BA4558RFVM	BA4558RFV	BA4558RFVM	BA14741F	BA4564RFV	BA4564RFV	BA4584FV
BA4560F	BA4560RF	BA4560RFV	BA4560RFVM	BA4560RFV	BA4560RFVM	BA4584RF	BA4584FV	BA4584FV	BA4584RFV
BA15218F	BA4580RF	BA4510FV	BA4580RFVM	BA4580RFV	BA4580RFVM				
BA15532F	BA8522RF	BA8522RFV	BA8522RFVM	BA8522RFV	BA8522RFVM				
BA4510F	BA2115F		BA2115FVM		BA2115FVM				

●Absolute maximum rating (Ta=25°C)

OBA4558/BA4558R family

Parameter	Symbol	Ratings		Unit
		BA4558 family	BA4558R family	
Supply Voltage	VCC-VEE	+36		V
Differential Input Voltage ^(*)	Vid	VCC-VEE	36	V
Input common-mode voltage range	Vicm	VEE~VCC	(VEE-0.3)~VEE+36	V
Operating Supply Voltage	Vopr	8~30 (±4~±15)		V
Operating Temperature	Topr	-40~+85	-40~+105	°C
Storage Temperature	Tstg	-55~+125	-55~+150	°C
Maximum Junction Temperature	Tjmax	+125	+150	°C

Note: Absolute maximum rating item indicates the condition which must not be exceeded.

Application of voltage in excess of absolute maximum rating or use out absolute maximum rated temperature environment may cause deterioration of characteristics.

(*) The voltage difference between inverting input and non-inverting input is the differential input voltage. Then input terminal voltage is set to more than VEE.

●Electrical characteristics

OBA4558 family (Unless otherwise specified VCC=+15[V], VEE=-15[V], Ta=25°C)

Parameter	Symbol	Temperature Range	Limits			Unit	Condition
			BA4558F				
			Min.	Typ.	Max.		
Input Offset Voltage ^(*)	Vio	25°C	-	0.5	6	mV	VOUT=0[V]
Input Offset Current ^(*)	Iio	25°C	-	5	200	nA	VOUT=0[V]
Input Bias Current ^(*)	Ib	25°C	-	60	500	nA	VOUT=0[V]
Supply Current	ICC	25°C	-	3	6	mA	RL=∞ All Op-Amps VIN+=0[V]
Maximum Output Voltage	VOM	25°C	±10	±13	-	V	RL ≥ 2[kΩ]
		25°C	±12	±14	-		RL ≥ 10[kΩ]
Large Signal Voltage Gain	AV	25°C	86	100	-	dB	RL ≥ 2[kΩ], VOUT=±10[V], Vicm=0[V]
Input Common-mode Voltage Range	Vicm	25°C	±12	±14	-	V	
Common-mode Rejection Ratio	CMRR	25°C	70	90	-	dB	Ri ≤ 10[kΩ]
Power Supply Rejection Ratio	PSRR	25°C	76.3	90	-	dB	Ri ≤ 10[kΩ]
Slew Rate	SR	25°C	-	1.0	-	V/μs	AV=0[dB], RL ≥ 2[kΩ]
Channel Separation	CS	25°C	-	105	-	dB	f=1[kHz]

(*) Absolute value

(*) Current direction: Since first input stage is composed with PNP transistor, input bias current flows out of IC.

●Electrical characteristics

OBA4558R family (Unless otherwise specified VCC=+15[V], VEE=-15[V], Ta=25[°C], Full range -40[°C]~+105[°C])

Parameter	Symbol	Temperature Range	Limits			Unit	Condition
			BA4558R F/FV/FVM				
			Min.	Typ.	Max.		
Input Offset Voltage ^(*4)	Vio	25°C	-	0.5	6	mV	VOUT=0[V]
		Full range	-	-	7		
Input Offset Current ^(*4)	Iio	25°C	-	5	200	nA	VOUT=0[V]
		Full range	-	-	200		
Input Bias Current ^(*5)	Ib	25°C	-	60	500	nA	VOUT=0[V]
		Full range	-	-	800		
Supply Current	ICC	25°C	-	3	6	mA	RL=∞ All Op-Amps VIN+=0[V]
		Full range	-	-	6.5		
Maximum Output Voltage	VOH	25°C	±10	±13	-	V	RL ≥ 2[kΩ]
		Full range	±10	-	-		RL ≥ 10[kΩ]
		25°C	±12	±14	-		
Large Signal Voltage Gain	AV	25°C	86	100	-	dB	RL ≥ 2[kΩ], VOUT=±10[V], Vcm=0[V]
		Full range	83	-	-		
Input Common-mode Voltage Range	Vicm	25°C	±12	±14	-	V	VOUT=±12[V]
		Full range	±12	-	-		
Common-mode Rejection Ratio	CMRR	25°C	70	90	-	dB	VOUT=±12[V]
Power Supply Rejection Ratio	PSRR	25°C	76.5	90	-	dB	Ri ≤ 10[kΩ]
Channel Separation	CS	25°C	-	105	-	dB	R1=100[Ω], f=1[kHz]
Slew Rate	SR	25°C	-	1	-	V/μs	AV=0[dB], RL=2[kΩ] CL=100[pF]
Unity Gain Frequency	ft	25°C	-	2	-	MHz	RL=2[kΩ]
Total Harmonic Distortion	THD	25°C	-	0.005	-	%	AV=20[dB], RL=10[kΩ] VIN=0.05[Vrms], f=1[kHz]
Input Referred Noise Voltage	Vn	25°C	-	12	-	nV/√Hz	RS=100[Ω], Vi=0[V], f=1[kHz]

(*4) Absolute value

(*5) Current direction: Since first input stage is composed with PNP transistor, input bias current flows out of IC.

●Absolute maximum rating (Ta=25°C)

OBA4560/BA4560R/BA4564R family

Parameter	Symbol	Ratings			Unit
		BA4560 family	BA4560R family	BA4564R family	
Supply Voltage	VCC-VEE	+36			V
Differential Input Voltage ^(*6)	Vid	VCC-VEE	36		V
Input Common-mode voltage range	Vicm	VEE~VCC	(VEE-0.3)~VEE+36		V
Operating Supply Voltage	Vopr	8~30 (±4~±15)			V
Operating Temperature	Topr	-40~+85	-40~+105		°C
Storage Temperature	Tstg	-55~+125	-55~+150		°C
Maximum junction Temperature	Tjmax	+125	+150		°C

Note: Absolute maximum rating item indicates the condition which must not be exceeded.

Application of voltage in excess of absolute maximum rating or use out absolute maximum rated temperature environment may cause deterioration of characteristics.

(*6) The voltage difference between inverting input and non-inverting input is the differential input voltage. Then input terminal voltage is set to more than VEE.

●Electrical characteristics

OBA4560 family (Unless otherwise specified VCC=+15[V], VEE=-15[V], Ta=25°C)

Parameter	Symbol	Temperature Range	Limits			Unit	Condition
			BA4560F				
			Min.	Typ.	Max.		
Input Offset Voltage ^(*7)	Vio	25°C	-	0.5	6	mV	VOUT=0[V]
Input Offset Current ^(*7)	Iio	25°C	-	5	200	nA	VOUT=0[V]
Input Bias Current ^(*8)	Ib	25°C	-	50	500	nA	VOUT=0[V]
Supply Current	ICC	25°C	-	4	7.5	mA	RL=∞ All Op-Amps, VIN+=0[V]
Maximum Output Voltage	VOH	25°C	±12	±14	-	V	RL ≥ 10[kΩ]
		25°C	±10	±13	-		RL ≥ 2[kΩ]
Large Signal Voltage Gain	AV	25°C	86	100	-	dB	RL ≥ 2[kΩ], VO=±10[V], Vicm=0[V]
Input Common-mode Voltage Range	Vicm	25°C	±12	±14	-	V	VOUT=±12[V]
Common-mode Rejection Ratio	CMRR	25°C	70	90	-	dB	VOUT=±12[V]
Power Supply Rejection Ratio	PSRR	25°C	76.3	90	-	dB	Ri ≤ 10[kΩ]
Slew Rate	SR	25°C	-	4	-	V/μs	AV=0[dB], RL=2[kΩ]
Unity Gain Frequency	GBW	25°C	-	10	-	MHz	f=10[kHz]
Input Referred Noise Voltage	Vn	25°C	-	-	2.2	μVrms	RS=2.2[Ω], RIAA BW=10[kHz]~30[kHz]

(*7) Absolute value

(*8) Current direction: Since first input stage is composed with PNP transistor, input bias current flows out of IC.

●Electrical characteristics

OBA4560R family (Unless otherwise specified VCC=+15[V], VEE=-15[V], Full range -40[°C]~+105[°C])

Parameter	Symbol	Temperature Range	Limits			Unit	Condition
			BA4560R F/FV/FVM				
			Min.	Typ.	Max.		
Input Offset Voltage ^(*9)	Vio	25°C	-	0.5	6	mV	VOUT=0[V]
		Full range	-	-	7		
Input Offset Current ^(*9)	Iio	25°C	-	5	200	nA	VOUT=0[V]
		Full range	-	-	200		
Input Bias Current ^(*10)	Ib	25°C	-	50	500	nA	VOUT=0[V]
		Full range	-	-	800		
Supply Current	ICC	25°C	-	3	7	mA	RL=∞ All Op-Amps VIN+=0[V]
		Full range	-	-	7.5		
Maximum Output Voltage	VOH	25°C	±12	±14	-	V	RL ≥ 2[kΩ]
		Full range	±10	±11.5	-		Io=25[mA]
Large Signal Voltage Gain	AV	25°C	86	100	-	dB	RL ≥ 2[kΩ], VO=±10[V], Vicm=0[V]
		Full range	83	-	-		
Input Common-mode Voltage Range	Vicm	25°C	±12	±14	-	V	VOUT=±12[V]
		Full range	±12	-	-		
Common-mode Rejection Ratio	CMRR	25°C	70	90	-	dB	VOUT=±12[V]
Power Supply Rejection Ratio	PSRR	25°C	76.5	90	-	dB	Ri ≤ 10[kΩ]
Channel Separation	CS	25°C	-	105	-	dB	R1=100[Ω], f=1[kHz]
Slew Rate	SR	25°C	-	4	-	V/μs	AV=0[dB], RL=10[kΩ] CL=100[pF]
Unity Gain Frequency	ft	25°C	-	4	-	MHz	RL=2[kΩ]
Total Harmonic Distortion	THD	25°C	-	0.003	-	%	AV=20[dB], RL=10[kΩ] VIN=0.05[Vrms], f=1[kHz]
Input Referred Noise Voltage	Vn	25°C	-	8	-	nV/√Hz	RS=100[Ω], Vi=0[V], f=1[kHz]

(*9) Absolute value

(*10) Current direction: Since first input stage is composed with PNP transistor, input bias current flows out of IC.

●Electrical characteristics

OBA4564R family (Unless otherwise specified VCC=+15[V], VEE=-15[V], Full range -40[°C]~+105[°C])

Parameter	Symbol	Temperature Range	Limits			Unit	Condition
			BA4564RFV				
			Min.	Typ.	Max.		
Input Offset Voltage ^(*11)	Vio	25°C	-	0.5	6	mV	VOUT=0[V]
		Full range	-	-	7		
Input Offset Current ^(*11)	Iio	25°C	-	5	200	nA	VOUT=0[V]
		Full range	-	-	200		
Input Bias Current ^(*12)	Ib	25°C	-	50	500	nA	VOUT=0[V]
		Full range	-	-	800		
Supply Current	ICC	25°C	-	6	14	mA	RL=∞ All Op-Amps VIN+=0[V]
		Full range	-	-	15		
Maximum Output Voltage	VOH	25°C	±12	±14	-	V	RL ≥ 2[kΩ]
		Full range	±10	±11.5	-		
Large Signal Voltage Gain	AV	25°C	86	100	-	dB	RL ≥ 2[kΩ], VOUT=±10[V], Vicm=0[V]
		Full range	83	-	-		
Input Common-mode Voltage Range	Vicm	25°C	±12	±14	-	V	VOUT=±12[V]
		Full range	±12	-	-		
Common-mode Rejection Ratio	CMRR	25°C	70	90	-	dB	VOUT=±12[V]
Power Supply Rejection Ratio	PSRR	25°C	76.5	90	-	dB	Ri ≤ 10[kΩ]
Channel Separation	CS	25°C	-	105	-	dB	R1=100[Ω], f=1[kHz]
Slew Rate	SR	25°C	-	4	-	V/μs	AV=0[dB], RL=10[kΩ] CL=100[pF]
Unity Gain Frequency	ft	25°C	-	4	-	MHz	RL=2[kΩ]
Total Harmonic Distortion	THD	25°C	-	0.003	-	%	AV=20[dB], RL=10[kΩ] VIN=0.05[Vrms], f=1[kHz]
Input Referred Noise Voltage	Vn	25°C	-	8	-	nV/√Hz	RS=100[Ω], Vi=0[V], f=1[kHz]

(*11) Absolute value

(*12) Current direction: Since first input stage is composed with PNP transistor, input bias current flows out of IC.

●Absolute maximum rating (Ta=25°C)

OBA4580/BA4584/BA4584R/BA8522R family

Parameter	Symbol	Ratings				Unit
		BA4580R family	BA4584 family	BA4584R family	BA8522R family	
Supply Voltage	VCC-VEE	+36				V
Differential Input Voltage ^(*13)	Vid	36				V
Input Common-mode Voltage Range	Vicm	VEE~VEE+36			(VEE-0.3)~VEE+36	V
Operating Supply Voltage	Vopr	4~32 (±2~±16)		4~19 (±2~±8.5)	4~32 (±2~±16)	V
Output current	Iout	±50				mA
Operating Temperature	Topr	-40~+105	-40~+85	-40~+105		°C
Storage Temperature	Tstg	-55~+150				°C
Maximum Junction Temperature	Tjmax	+150				°C

Note Absolute maximum rating item indicates the condition which must not be exceeded.

Application of voltage in excess of absolute maximum rating or use out absolute maximum rated temperature environment may cause deterioration of characteristics.

(*13) The voltage difference between inverting input and non-inverting input is the differential input voltage. Then input terminal voltage is set to more than VEE.

●Electrical characteristics

OBA4580R family (Unless otherwise specified VCC=+15[V], VEE=-15[V], Ta=25°C)

Parameter	Symbol	Temperature Range	Limits			Unit	Condition
			BA4580R F/FVM				
			Min.	Typ.	Max.		
Input Offset Voltage ^(*14)	Vio	25°C	-	0.3	3	mV	Rs ≤ 10[kΩ]
Input Offset Current ^(*14)	Iio	25°C	-	5	200	nA	
Input Bias Current ^(*15)	Ib	25°C	-	100	500	nA	
Large Signal Voltage Gain	AV	25°C	90	110	-	dB	RL ≥ 10[kΩ], VOUT=±10[V]
Maximum Output Voltage	VOM	25°C	±12	±13.5	-	V	RL ≥ 2[kΩ]
Input Common-mode Voltage Range	Vicm	25°C	±12	±13.5	-	V	
Common-mode Rejection Ratio	CMRR	25°C	80	110	-	dB	Rs ≤ 10[kΩ]
Power Supply Rejection Ratio	PSRR	25°C	80	110	-	dB	Rs ≤ 10[kΩ]
Supply Current	ICC	25°C	-	6	9	mA	RL=∞ All Op-Amps, VIN+=0[V]
Slew Rate	SR	25°C	-	5	-	V/μs	RL ≥ 2[kΩ]
Unity Gain Frequency	ft	25°C	-	5	-	MHz	RL=2[kΩ]
Total Harmonic Distortion	THD	25°C	-	0.0005	-	%	Av=20[dB], VOUT=5[Vrms] RL=2[kΩ], f=1[kHz] 20[Hz]~20[kHz] BPF
Input Referred Noise Voltage	Vn	25°C	-	0.8	-	μVrms	RIAA, Rs=2.2 [kΩ], 30[kHz] LPF

(*14) Absolute value

(*15) Current direction: Since first input stage is composed with PNP transistor, input bias current flows out of IC.

●Electrical characteristics

OBA4584 family (Unless otherwise specified VCC=+15[V], VEE=-15[V], Ta=25[°C])

Parameter	Symbol	Temperature Range	Limits			Unit	Condition
			BA4584FV				
			Min.	Typ.	Max.		
Input Offset Voltage ^(*16)	Vio	25°C	-	0.3	3	mV	Rs ≤ 10[kΩ]
Input Offset Current ^(*16)	Iio	25°C	-	5	200	nA	
Input Bias Current ^(*17)	Ib	25°C	-	100	500	nA	
Large Signal Voltage Gain	AV	25°C	90	110	-	dB	RL ≥ 10[kΩ], VOUT=±10[V]
Maximum Output Voltage	VOM	25°C	±12	±13.5	-	V	RL ≥ 2[kΩ]
Input Common-mode Voltage Range	Vicm	25°C	±12	±13.5	-	V	
Common-mode Rejection Ratio	CMRR	25°C	80	110	-	dB	Rs ≤ 10[kΩ]
Power Supply Rejection Ratio	PSRR	25°C	80	110	-	dB	Rs ≤ 10[kΩ]
Supply Current	ICC	25°C	-	12	18	mA	RL=∞ All Op-Amps, VIN+=0[V]
Slew Rate	SR	25°C	-	5	-	V/μs	RL ≥ 2[kΩ]
Unity Gain Frequency	ft	25°C	-	5	-	MHz	RL=2[kΩ]
Total Harmonic Distortion	THD	25°C	-	0.0005	-	%	Av=20[dB], VOUT=5[Vrms] RL=2[kΩ], f=1[kHz] 20[Hz]~20[kHz] BPF
Input Referred Noise Voltage	Vn	25°C	-	0.8	-	μVrms	RIAA, Rs=2.2[kΩ], 30[kHz] LPF

(*16) Absolute value

(*17) Current direction: Since first input stage is composed with PNP transistor, input bias current flows out of IC.

●Electrical characteristics

OBA4584R family (Unless otherwise specified VCC=+9.5[V], VEE=-9.5[V], Ta=25[°C])

Parameter	Symbol	Temperature Range	Limits			Unit	Condition
			BA4584R F/FV				
			Min.	Typ.	Max.		
Input Offset Voltage (*18)	Vio	25°C	-	0.3	3	mV	Rs ≤ 10[kΩ]
Input Offset Current (*18)	Iio	25°C	-	5	200	nA	
Input Bias Current (*19)	Ib	25°C	-	100	500	nA	
Large Signal Voltage Gain	AV	25°C	90	110	-	dB	RL ≥ 10[kΩ], VOUT=±10[V]
Maximum Output Voltage	VOM	25°C	±6.5	±8	-	V	RL ≥ 2[kΩ]
Input Common-mode Voltage Range	Vicm	25°C	±6.5	±8	-	V	
Common-mode Rejection Ratio	CMRR	25°C	80	110	-	dB	Rs ≤ 10[kΩ]
Power Supply Rejection Ratio	PSRR	25°C	80	110	-	dB	Rs ≤ 10[kΩ]
Supply Current	ICC	25°C	-	11	17	mA	RL=∞ All Op-Amps, VIN+=0[V]
Slew Rate	SR	25°C	-	5	-	V/μs	RL ≥ 2[kΩ]
Unity Gain Frequency	ft	25°C	-	5	-	MHz	RL=2[kΩ]
Total Harmonic Distortion	THD	25°C	-	0.0005	-	%	Av=20[dB], VOUT=5[Vrms] RL=2[kΩ], f=1[kHz] 20[Hz]~20[kHz] BPF
Input Referred Noise Voltage	Vn	25°C	-	0.8	-	μVrms	RIAA, Rs=2.2[kΩ], 30[kHz] LPF

(*18) Absolute value

(*19) Current direction: Since first input stage is composed with PNP transistor, input bias current flows out of IC.

●Electrical characteristics

OBA8522R family (Unless otherwise specified VCC=+15[V], VEE=-15[V], Ta=25[°C])

Parameter	Symbol	Temperature Range	Limits			Unit	Condition
			BA8522R F/FV/FVM				
			Min.	Typ.	Max.		
Input Offset Voltage ^(*20)	Vio	25°C	-	0.1	1.5	mV	
Input Offset Voltage drift ^(*20)	Vio/ΔT		-	2	-	μV/°C	
Input Offset Current ^(*20)	Iio	25°C	-	5	200	nA	
Input Bias Current ^(*21)	Ib	25°C	-	50	500	nA	
Supply Current	ICC	25°C	-	5.5	9	mA	RL=∞ All Op-Amps VIN+=0[V]
Maximum Output Voltage	VOM	25°C	±12	±13.5		V	RL ≥ 10[kΩ]
			±10.5	±11	-	V	RL ≥ 2[kΩ]
Large Signal Voltage Gain	AV	25°C	86	110	-	dB	RL ≥ 10[kΩ], VOUT=±10[V]
Input Common-mode Voltage Range	Vicm	25°C	±12	±14	-	V	
Common-mode Rejection Ratio	CMRR	25°C	70	90	-	dB	
Power Supply Rejection Ratio	PSRR	25°C	76.5	90	-	dB	
Channel Separation	CS	25°C	-	105	-	dB	
Slew Rate	SR	25°C	-	3	-	V/μs	
Unity Gain Frequency	ft	25°C	-	6	-	MHz	
Input Referred Noise Voltage	Vni	25°C	-	1.2	-	μVrms	
Total Harmonic Distortion	THD	25°C	-	0.002	-	%	Av=20[dB], VOUT=5[Vrms] f=1[kHz]

(*20) Absolute value

(*21) Current direction: Since first input stage is composed with PNP transistor, input bias current flows out of IC.

●Absolute maximum rating (Ta=25°C)

OBA15218/BA14741/BA15532 family

Parameter	Symbol	Ratings			Unit
		BA15218 family	BA14741 family	BA15532 family	
Supply Voltage	VCC-VEE	36		42	V
Differential Input Voltage ^(*22)	Vid	VCC-VEE		±0.5 ^(*23)	V
Input Common-mode voltage range	Vicm	VEE~VCC			V
Operating Supply Voltage	Vopr	4~32 (±2~±16)	4~36 (±2~±18)	6~40 (±3~±20)	V
Input Current	Ii	-		±10	mA
Operating Temperature	Topr	-40+85		-20~+75	°C
Storage Temperature	Tstg	-55~+125			°C
Output Short Current ^(*24)	Iomax	±50	-		mA
Output Short Time ^(*24)	Ts	-	unlimited (only 1CH short)	unlimited	Sec

Note: Absolute maximum rating item indicates the condition which must not be exceeded.

Application of voltage in excess of absolute maximum rating or use out absolute maximum rated temperature environment may cause deterioration of characteristics.

(*22) The voltage difference between inverting input and non-inverting input is the differential input voltage.

Then input terminal voltage is set to more than VEE.

(*23) Don't over input current ±10mA. Built-in resistor for protection because of over current with differential input voltage above 0.5 .

(*24) Limit within Pd.

●Electrical characteristics

OBA15218 family (Unless otherwise specified VCC=+15[V], VEE=-15[V], Ta=25°C)

Parameter	Symbol	Temperature Range	Limits			Unit	Condition
			BA15218F				
			Min.	Typ.	Max.		
Input Offset Voltage ^(*25)	Vio	25°C	-	0.5	5.0	mV	Rs ≤ 10[kΩ]
Input Offset Current ^(*25)	Iio	25°C	-	5	200	nA	
Input Bias Current ^(*26)	Ib	25°C	-	50	500	nA	
Large Signal Voltage Gain	Av	25°C	86	110	-	dB	RL ≥ 2[kΩ], Vo=±10[V]
Input Common-mode Voltage Range	Vicm	25°C	±12	±14	-	V	
Common-mode Rejection Ratio	CMRR	25°C	70	90	-	dB	Rs ≤ 10[kΩ]
Power Supply Rejection Ratio	PSRR	25°C	76	90	-	dB	Rs ≤ 10[kΩ]
Supply Current	ICC	25°C	-	5.0	8.0	mA	Vin=0, RL=∞
Maximum Output Voltage	VOH	25°C	±12	±14	-	V	RL ≥ 10[kΩ]
	VOL	25°C	±10	±13	-	V	RL ≥ 2[kΩ]
Slew Rate	SR	25°C	-	3.0	-	V/μs	GV=0[dB], RL=2[kΩ]
Gain Bandwidth Product	GBW	25°C	-	10	-	MHz	f=10[KHz]
Input Referred Noise Voltage	Vn	25°C	-	1.0	-	μVrms	RS=1[kΩ], BW=20[Hz]~30[kHz], RIAA
Channel Separation	CS	25°C	-	120	-	dB	f=1[kHz] input referred

(*25) Absolute value

(*26) Current direction: Since first input stage is composed with PNP transistor, input bias current flows out of IC.

●Electrical characteristics

OBA14741 family (Unless otherwise specified VCC=+15[V], VEE=-15[V], Ta=25[°C])

Parameter	Symbol	Temperature Range	Limits			Unit	Condition	
			BA14741F					
			Min.	Typ.	Max.			
Input Offset Voltage ^(*27)	Vio	25°C	-	1.0	5.0	mV	Rs ≤ 10[kΩ]	
Input Offset Current ^(*27)	Iio	25°C	-	10	50	nA		
Input Bias Current ^(*28)	Ib	25°C	-	60	300	nA		
Large Signal Voltage Gain	Av	25°C	20	100	-	V/mV	RL ≥ 2[kΩ], Vo=±10[V]	
Common-mode Rejection Ratio	CMRR	25°C	80	100	-	dB		
Input Common-mode Voltage Range	Vicm	25°C	±12	±13.5	-	V		
Power Supply Rejection Ratio	PSRR	25°C	80	100	-	dB		
Supply Current	ICC	25°C	-	3.0	7.0	mA	RL=∞ All Op-Amps	
Maximum Output Voltage	VOH	25°C	10	12.5	-	V	Vin+=1[V], Vin-=0[V], RL=2[kΩ]	
	VOL	25°C	-10	-12.5	-	V	Vin+=0[V], Vin-=1[V], RL=2[kΩ]	
Maximum Output Current	Source	IOH	25°C	10	20	-	mA	Vin+=1[V], Vin-=0[V], VO=0[V]
	Sink	IOL	25°C	5	10	-	mA	Vin+=0[V], Vin-=1[V], VO=0[V]
Slew Rate	SR	25°C	-	1.0	-	V/μs	Av=1, RL=2[kΩ]	
Input Referred Noise Voltage	Vn	25°C	-	2.0	4.0	μVrms	RIAA, Rs=2.2[kΩ], 10[Hz]~30[kHz]	
Channel Separation	CS	25°C	-	100	-	dB	f=1[kHz] input referred	

(*27) Absolute value.

(*28) Current direction: Since first input stage is composed with PNP transistor, input bias current flows out of IC.

●Electrical characteristics

OBA15532 family (Unless otherwise specified VCC=+15[V], VEE=-15[V], Ta=25[°C])

Parameter	Symbol	Temperature Range	Limits			Unit	Condition
			BA15532F				
			Min.	Typ.	Max.		
Input Offset Voltage ^(*29)	Vio	25°C	-	0.5	4.0	mV	Rs=50[Ω], RL ≥ 10[kΩ]
Input Offset Current ^(*29)	Iio	25°C	-	10	150	nA	RL ≥ 10[kΩ]
Input Bias Current ^(*30)	Ib	25°C	-	200	800	nA	RL ≥ 10[kΩ]
Large Signal Voltage Gain	Av	25°C	80	94	-	dB	RL ≥ 600[Ω], Vo=±10[V]
Common-mode Rejection Ratio	CMRR	25°C	70	100	-	dB	RL ≥ 10[kΩ]
Input Common-mode Voltage Range	Vicm	25°C	±12	±13	-	V	RL ≥ 10[kΩ]
Power Supply Rejection Ratio	PSRR	25°C	80	100	-	dB	Rs=50[Ω], RL ≥ 10[kΩ]
Supply Current	Icc	25°C	-	8.0	16.0	mA	RL=∞ All Op-Amps
Maximum Output Voltage	VOH	25°C	±12	±13	-	V	RL ≥ 600[Ω]
	VOL	25°C	±15	±16	-	V	RL ≥ 600[Ω] VCC=18[V], VEE=-18[V]
Output Short Current ^(*31)	IOS	25°C	-	38	-	mA	
Slew Rate	SR	25°C	-	8.0	-	V/μs	Av=1, RL=600[Ω], CL=100[pF]
Gain Bandwidth Product	GBW	25°C	-	20	-	MHz	f=10[kHz], RL=600[Ω], CL=100[pF]
Input Referred Noise Voltage	Vn	25°C	-	0.7	1.5	μVrms	RIAA, Rs=100[Ω], 20[Hz]~30[kHz]
Channel Separation	CS	25°C	-	110	-	dB	RIAA Input referred

(*29) Absolute value

(*30) Current direction: Since first input stage is composed with NPN transistor, input bias current flows out of IC.

(*31) In the case of output pin shorting with VCC or VEE. But never over the maximum power dissipation

●Absolute maximum rating (Ta=25°C)

OBA4510/BA2115 family

Parameter	Symbol	Ratings		Unit
		BA4510 family	BA2115 family	
Supply Voltage	VCC-VEE	10	14	V
Differential Input Voltage ^(*32)	Vid	VCC-VEE	14	V
Input Common-mode Voltage Range	Vicm	VEE~VCC	(VEE-0.3)~VEE+14	V
Operating Supply Voltage	Vopr	2~7(±1~±3.5)	2~14(±1~±7)	V
Operating Temperature	Topr	-20~+75	-40~+85	°C
Storage Temperature	Tstg	-40~125	-55~150	°C
Maximum Junction Temperature	Tjmax	125	150	°C

Note: Absolute maximum rating item indicates the condition which must not be exceeded.

Application of voltage in excess of absolute maximum rating or use out absolute maximum rated temperature environment may cause deterioration of characteristics.

(*32) The voltage difference between inverting input and non-inverting input is the differential input voltage.

Then input terminal voltage is set to more than VEE.

●Electrical characteristics

OBA4510 family (Unless otherwise specified VCC=+2.5[V], VEE=-2.5[V], Ta=25°C)

Parameter	Symbol	Temperature Range	Limits			Unit	Condition
			BA4510F/FV				
			Min.	Typ.	Max.		
Input Offset Voltage ^(*33)	Vio	25°C	-	1	6	mV	Rs=50[Ω]
Input Offset Current ^(*33)	Iio	25°C	-	2	200	nA	
Input Bias Current ^(*34)	Ib	25°C	-	80	500	nA	
Supply Current	ICC	25°C	2.5	5.0	7.5	mA	RL=∞ All Op-Amps
Maximum Output Voltage	VOH	25°C	+2.0	+2.4	-	V	RL=10[kΩ]
	VOL	25°C	-	-2.4	-2.0	V	RL=10[kΩ]
Large Signal Voltage Gain	Av	25°C	60	90	-	dB	RL ≥ 10[kΩ]
Input Common-mode Voltage Range	Vicm	25°C	-1.3	-	+1.5	V	
Common-mode Rejection Ratio	CMRR	25°C	60	80	-	dB	
Power Supply Rejection Ratio	PSRR	25°C	60	80	-	dB	Rs=50[Ω]
Slew Rate	SR	25°C	-	5.0	-	V/μs	Av=1

(*33) Absolute value

(*34) Current direction: Since first input stage is composed with PNP transistor, input bias current flows out of IC.

●Electrical characteristics

OBA2115 family (Unless otherwise specified VCC=+2.5[V], VEE=-2.5[V], Ta=25°C)

Parameter	Symbol	Temperature Range	Limits			Unit	Condition
			BA2115F/FVM				
			Min.	Typ.	Max.		
Input Offset Voltage ^(*35)	Vio	25°C	-	1	6	mV	VOUT=0[V], Vicm=0[V]
Input Offset Current ^(*35)	Iio	25°C	-	2	200	nA	VOUT=0[V], Vicm=0[V]
Input Bias Current ^(*36)	Ib	25°C	-	150	400	nA	VOUT=0[V], Vicm=0[V]
Supply Current	ICC	25°C	-	3.5	5	mA	RL=∞ All Op-Amps, VIN+=0[V]
Maximum Output Voltage	VOM	25°C	±2.0	±2.2	-	V	RL ≥ 2.5[kΩ]
Large Signal Voltage Gain	AV	25°C	60	80	-	dB	RL ≥ 10[kΩ], VOUT=±2[V], Vicm=0[V]
Input Common-mode Voltage Range	Vicm	25°C	±1.5	-	-	V	
Common-mode Rejection Ratio	CMRR	25°C	60	74	-	dB	Vicm=-1.5[V]~+1.5[V]
Power Supply Rejection Ratio	PSRR	25°C	60	80	-	dB	VCC=+2[V]~+14[V]
Slew Rate	SR	25°C	-	4	-	V/μs	AV=0[dB], VIN=±1[V]
Gain Bandwidth Product	GB	25°C	-	12	-	MHz	f=10[kHz]

(*35) Absolute value

(*36) Current direction: Since first input stage is composed with PNP transistor, input bias current flows out of IC.

●Reference Data BA4558 family

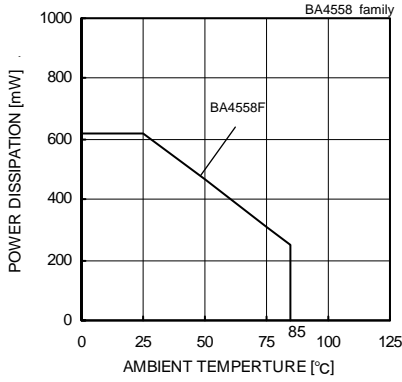

Fig. 1
Derating Curve

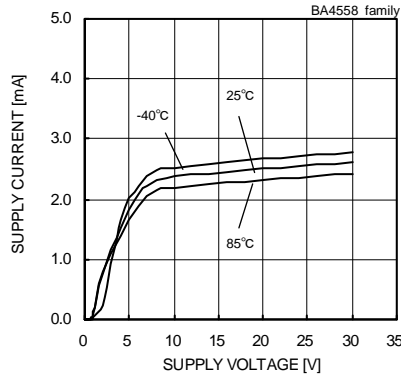

Fig. 2
Supply Current - Supply Voltage

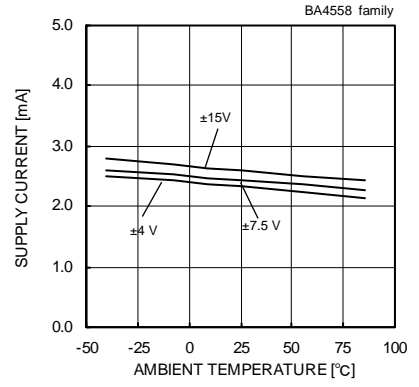

Fig. 3
Supply Current - Ambient Temperature

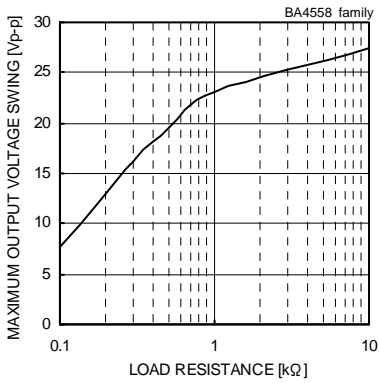

Fig. 4
Maximum Output Voltage Swing
- Load Resistance
(VCC/VEE=+15[V]/-15[V], Ta=25[°C])

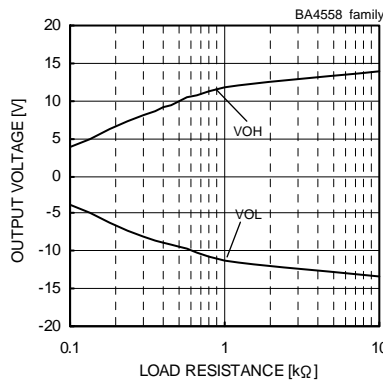

Fig. 5
Maximum Output Voltage
- Load Resistance
(VCC/VEE=+15[V]/-15[V], Ta=25[°C])

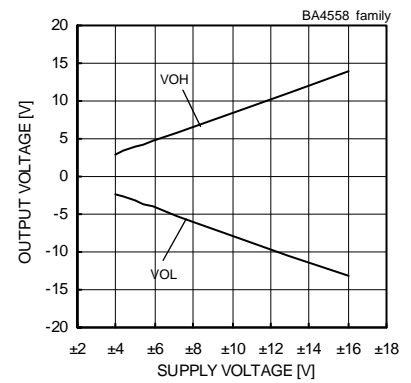

Fig. 6
Maximum Output Voltage
- Supply Voltage
(RL=2[kΩ], Ta=25[°C])

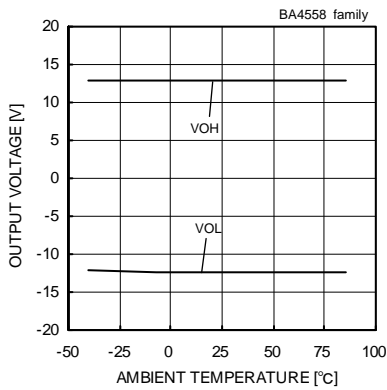

Fig. 7
Maximum Output Voltage
- Ambient Temperature
(VCC/VEE=+15[V]/-15[V], RL=2[kΩ])

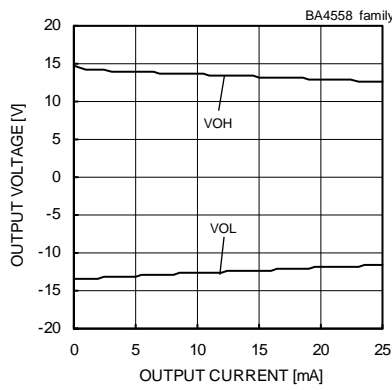

Fig. 8
Maximum Output Voltage
- Output Current
(VCC/VEE=+15[V]/-15[V], Ta=25[°C])

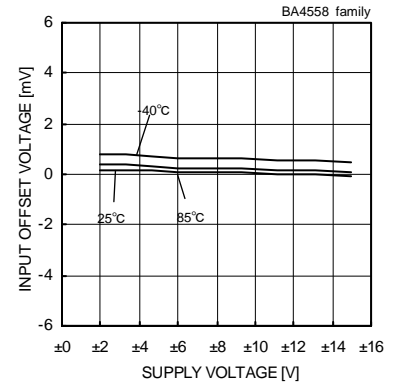

Fig. 9
Input Offset Voltage - Supply Voltage
(Vcm=0[V], Vout=0[V])

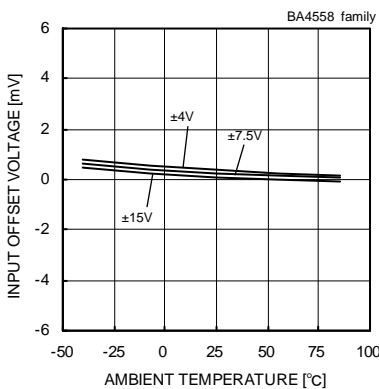

Fig. 10
Input Offset Voltage - Ambient Temperature
(Vcm=0[V], Vout=0[V])

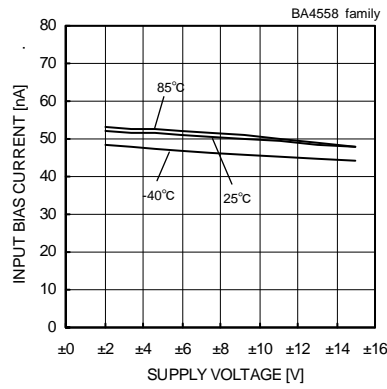

Fig. 11
Input Bias Current - Supply Voltage
(Vcm=0[V], Vout=0[V])

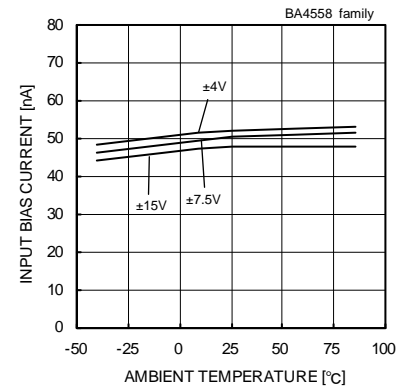

Fig. 12
Input Bias Current - Ambient Temperature
(Vcm=0[V], Vout=0[V])

(*)The above data is ability value of sample, it is not guaranteed.

●Reference Data BA4558 family

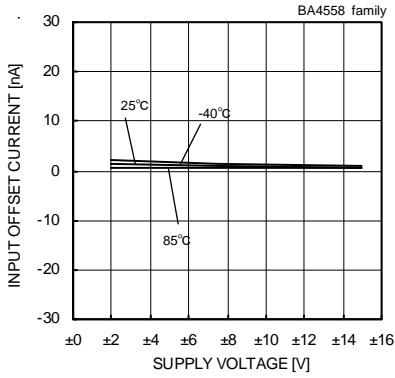

Fig.13
Input Offset Current - Supply Voltage
($V_{icm}=0[V]$, $V_{out}=0[V]$)

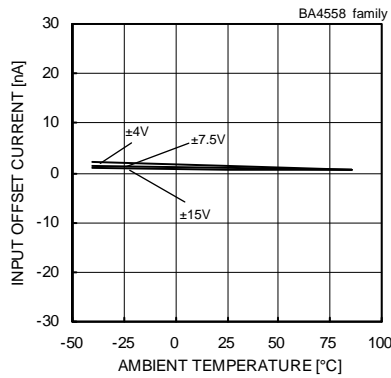

Fig.14
Input Offset Current - Ambient Temperature
($V_{icm}=0[V]$, $V_{out}=0[V]$)

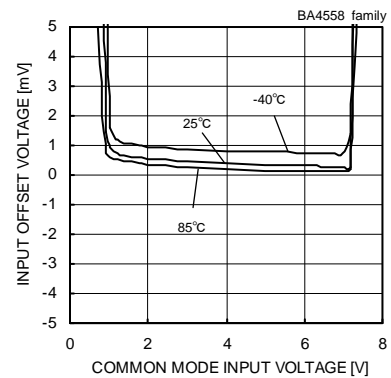

Fig.15
Input Offset Voltage - Common Mode Input Voltage
($V_{CC}=8[V]$, $V_{out}=4[V]$)

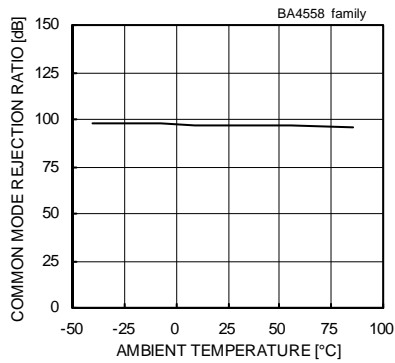

Fig.16
Common Mode Rejection Ratio - Ambient Temperature
($V_{CC}/V_{EE}=+15[V]/-15[V]$, $V_{icm}=-12[V]$ to $+12[V]$)

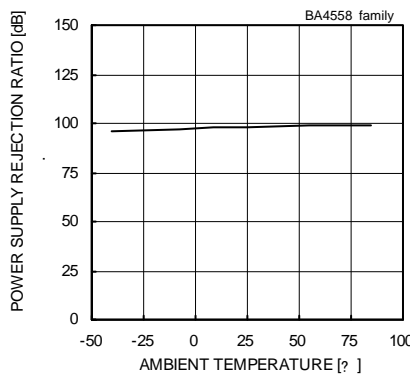

Fig.17
Power Supply Rejection Ratio - Ambient Temperature
($V_{CC}/V_{EE}=+4[V]/-4[V]$ to $+15[V]/-15[V]$)

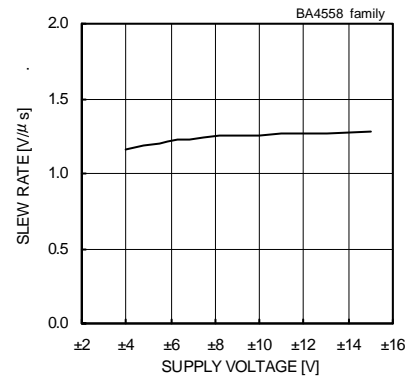

Fig.18
Slew Rate - Supply Voltage
($C_L=100[pF]$, $R_L=2[k\Omega]$, $T_a=25[^\circ C]$)

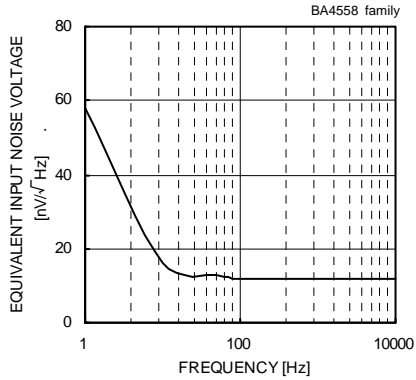

Fig.19
Equivalent Input Noise Voltage - Frequency
($V_{CC}/V_{EE}=+15[V]/-15[V]$, $R_s=100[\Omega]$, $T_a=25[^\circ C]$)

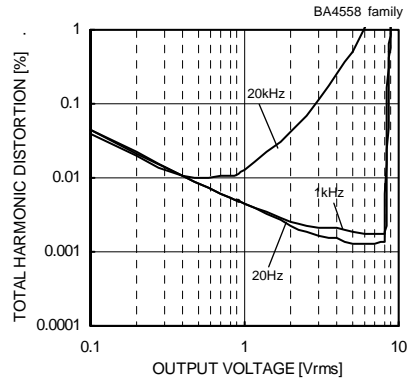

Fig.20
Total Harmonic Distortion - Output Voltage
($V_{CC}/V_{EE}=+15[V]/-15[V]$, $A_v=20[dB]$, $R_L=2[k\Omega]$, $80[kHz]$ -LPF, $T_a=25[^\circ C]$)

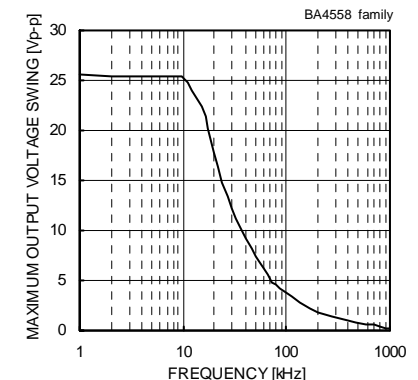

Fig.21
Maximum Output Voltage Swing - Frequency
($V_{CC}/V_{EE}=+15[V]/-15[V]$, $R_L=2[k\Omega]$, $T_a=25[^\circ C]$)

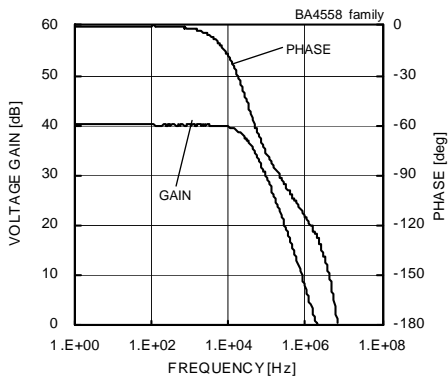

Fig.22
Voltage Gain - Frequency
($V_{CC}/V_{EE}=+15[V]/-15[V]$, $A_v=40[dB]$, $R_L=2[k\Omega]$, $T_a=25[^\circ C]$)

(*)The above data is ability value of sample, it is not guaranteed.

●Reference Data BA4558 family

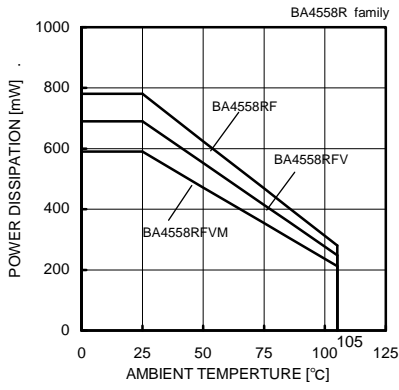

Fig. 23
Derating Curve

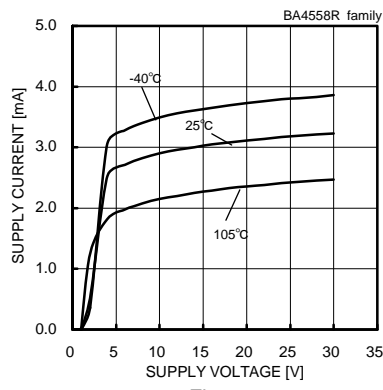

Fig. 24
Supply Current - Supply Voltage

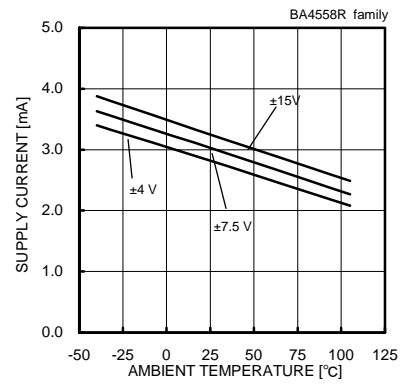

Fig. 25
Supply Current - Ambient Temperature

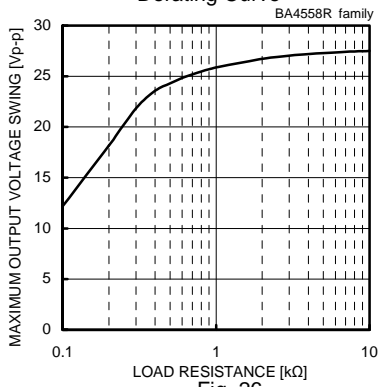

Fig. 26
Maximum Output Voltage Swing
- Load Resistance
(VCC/VEE=±15[V]/-15[V], Ta=25[°C])

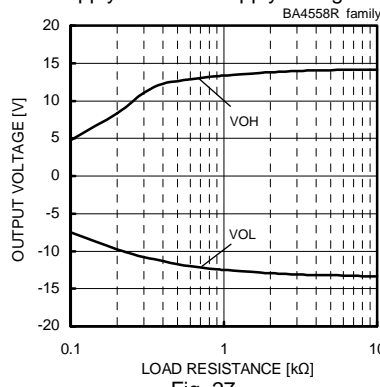

Fig. 27
Maximum Output Voltage
- Load Resistance
(VCC/VEE=±15[V]/-15[V], Ta=25[°C])

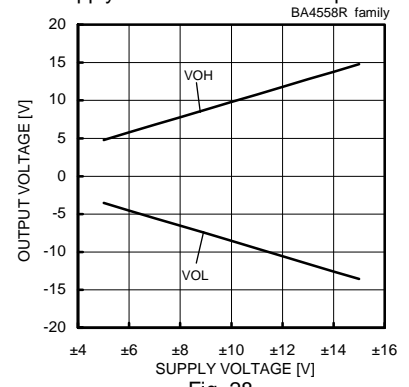

Fig. 28
Maximum Output Voltage
- Supply Voltage
(RL=2[kΩ], Ta=25[°C])

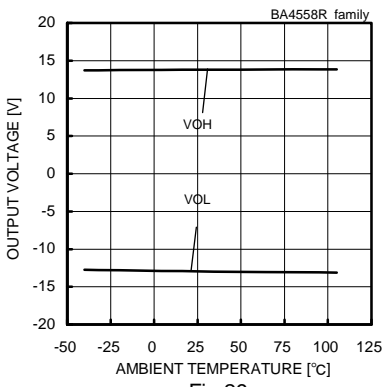

Fig. 29
Maximum Output Voltage
- Ambient Temperature
(VCC/VEE=±15[V]/-15[V], RL=2[kΩ])

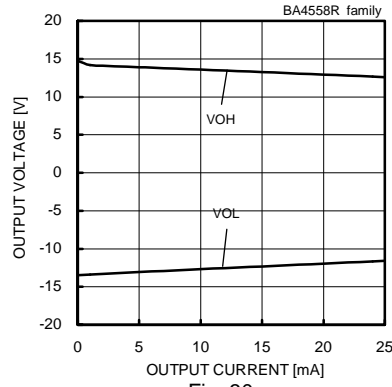

Fig. 30
Maximum Output Voltage
- Output Current
(VCC/VEE=±15[V]/-15[V], Ta=25[°C])

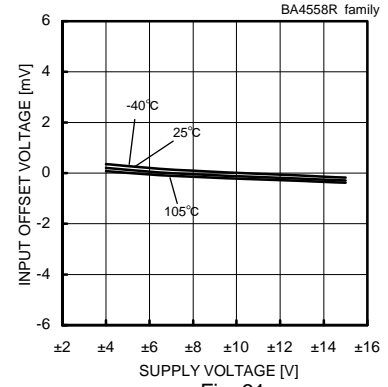

Fig. 31
Input Offset Voltage - Supply Voltage
(Vicm=0[V], Vout=0[V])

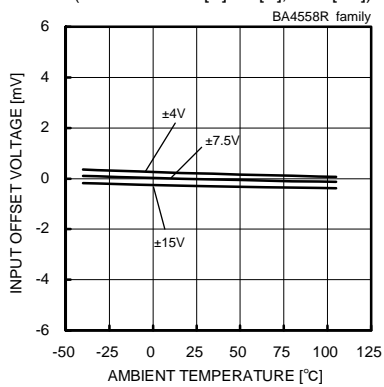

Fig. 32
Input Offset Voltage - Ambient Temperature
(Vicm=0[V], Vout=0[V])

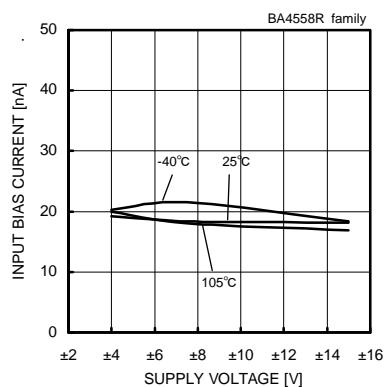

Fig. 33
Input Bias Current - Supply Voltage
(Vicm=0[V], Vout=0[V])

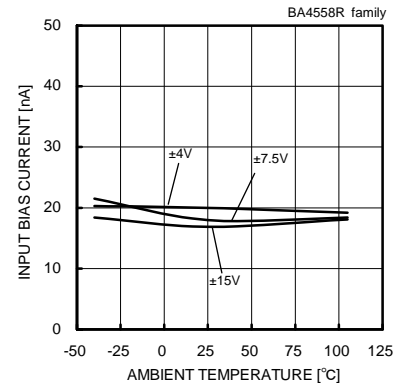

Fig. 34
Input Bias Current - Ambient Temperature
(Vicm=0[V], Vout=0[V])

(*)The above data is ability value of sample, it is not guaranteed.

●Reference Data BA4558 family

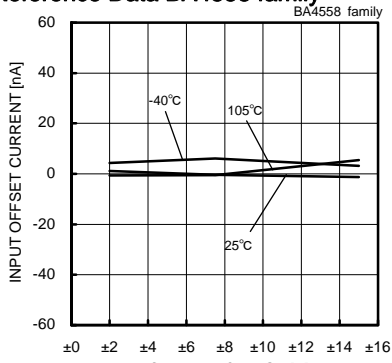

Fig. 35
Input Offset Current - Supply Voltage
($V_{icm}=0[V]$, $V_{out}=0[V]$)

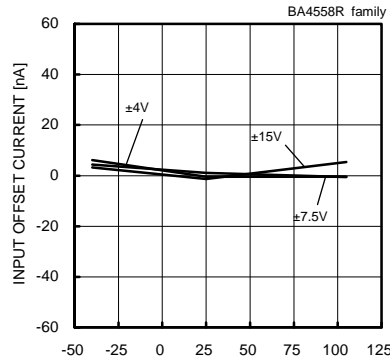

Fig. 36
Input Offset Current - Ambient Temperature
($V_{icm}=0[V]$, $V_{out}=0[V]$)

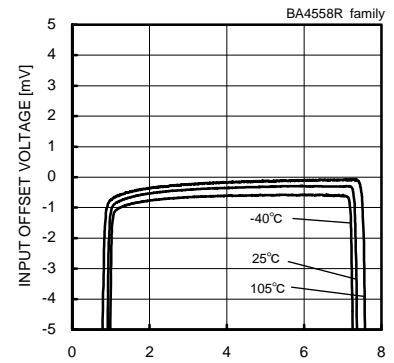

Fig. 37
Input Offset Voltage
- Common Mode Input Voltage
($V_{CC}=8[V]$, $V_{out}=4[V]$)

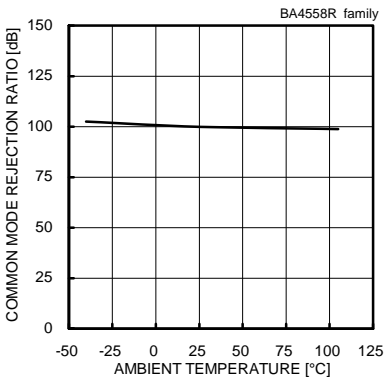

Fig. 38
Common Mode Rejection Ratio
- Ambient Temperature
($V_{CC}/V_{EE}=+15[V]/-15[V]$, $V_{icm}=-12[V]$ to $+12[V]$)

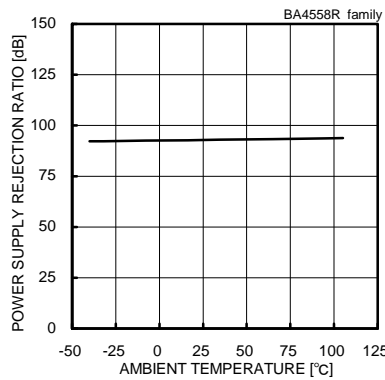

Fig. 39
Power Supply Rejection Ratio
- Ambient Temperature
($V_{CC}/V_{EE}=+4[V]/-4[V]$ to $+15[V]/-15[V]$)

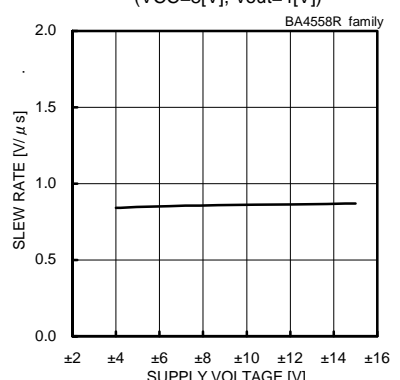

Fig. 40
Slew Rate - Supply Voltage
($C_L=100[pF]$, $R_L=2[k\Omega]$, $T_a=25[^\circ C]$)

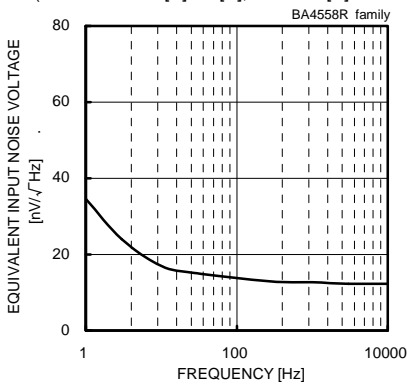

Fig. 41
Equivalent Input Noise Voltage - Frequency
($V_{CC}/V_{EE}=+15[V]/-15[V]$, $R_s=100[\Omega]$, $T_a=25[^\circ C]$)

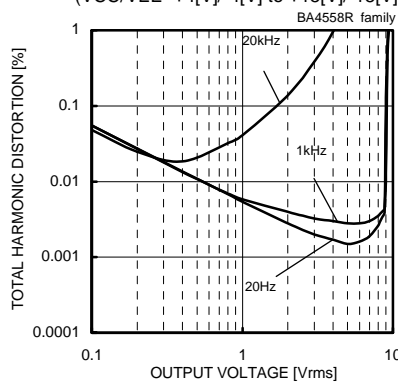

Fig. 42
Total Harmonic Distortion - Output Voltage
($V_{CC}/V_{EE}=+15[V]/-15[V]$, $A_v=20[dB]$,
 $R_L=2[k\Omega]$, $80[kHz]$ -LPF, $T_a=25[^\circ C]$)

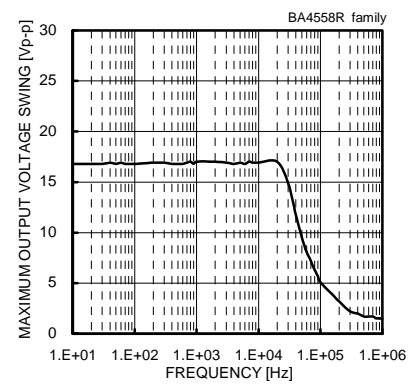

Fig. 43
Maximum Output Voltage Swing - Frequency
($V_{CC}/V_{EE}=+15[V]/-15[V]$, $R_L=2[k\Omega]$, $T_a=25[^\circ C]$)

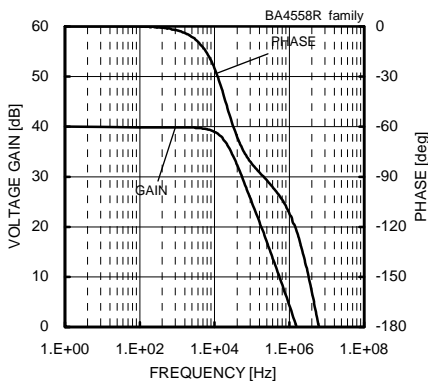

Fig. 44
Voltage Gain - Frequency
($V_{CC}/V_{EE}=+15[V]/-15[V]$, $A_v=40[dB]$, $R_L=2[k\Omega]$, $T_a=25[^\circ C]$)

(*)The above data is ability value of sample, it is not guaranteed.

●Reference Data BA4560 family

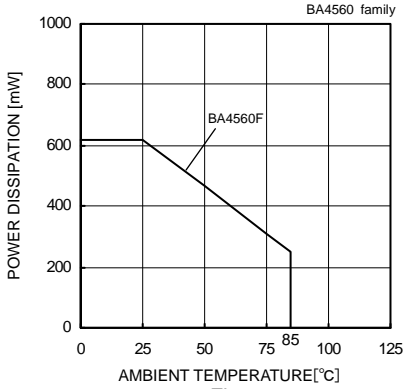

Fig. 45

Derating Curve

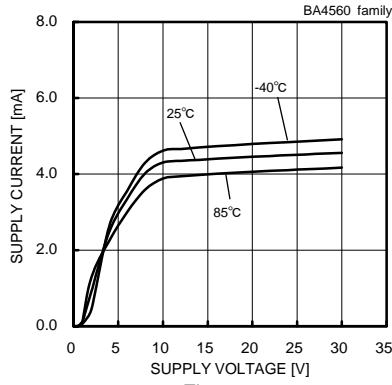

Fig. 46

Supply Current - Supply Voltage

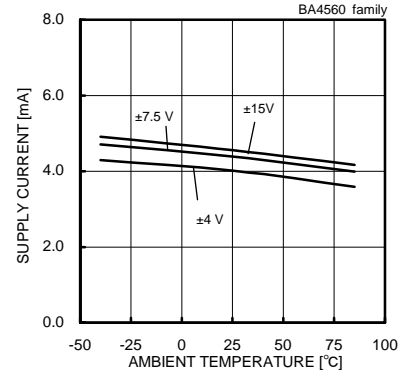

Fig. 47

Supply Current - Ambient Temperature

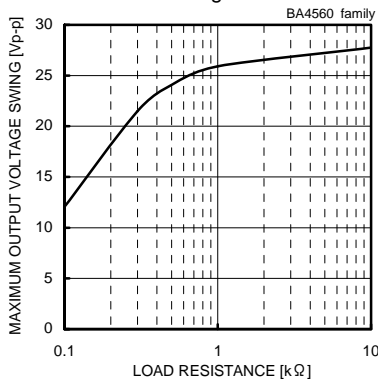

Fig. 48

Maximum Output Voltage Swing - Load Resistance

(VCC/VEE=+15[V]/-15[V], Ta=25[°C])

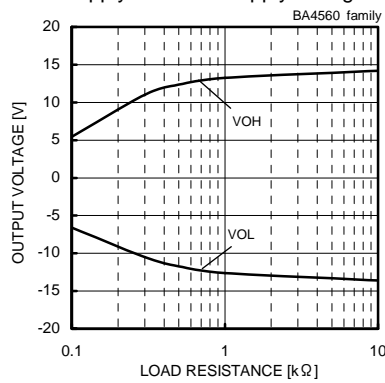

Fig. 49

Maximum Output Voltage - Load Resistance

(VCC/VEE=+15[V]/-15[V], Ta=25[°C])

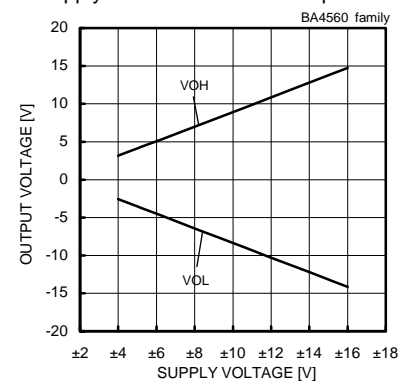

Fig. 50

Maximum Output Voltage - Supply Voltage

(RL=2[kΩ], Ta=25[°C])

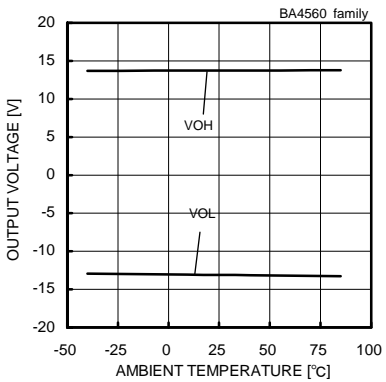

Fig. 51

Maximum Output Voltage - Ambient Temperature

(VCC/VEE=+15[V]/-15[V], RL=2[kΩ])

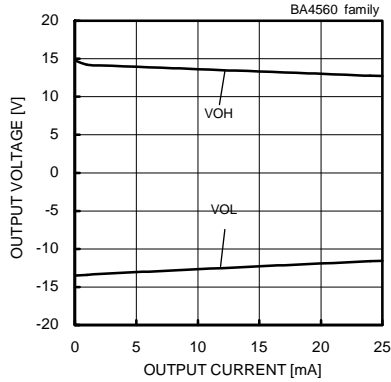

Fig. 52

Maximum Output Voltage - Output Current

(VCC/VEE=+15[V]/-15[V], Ta=25[°C])

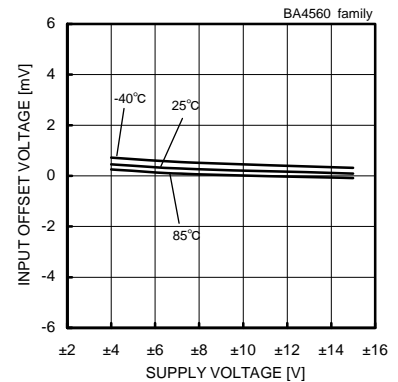

Fig. 53

Input Offset Voltage - Supply Voltage

(Vicm=0[V], Vout=0[V])

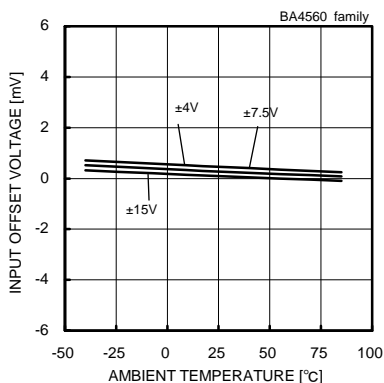

Fig. 54

Input Offset Voltage - Ambient Temperature

(Vicm=0[V], Vout=0[V])

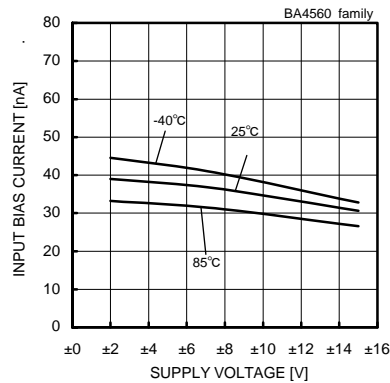

Fig. 55

Input Bias Current - Supply Voltage

(Vicm=0[V], Vout=0[V])

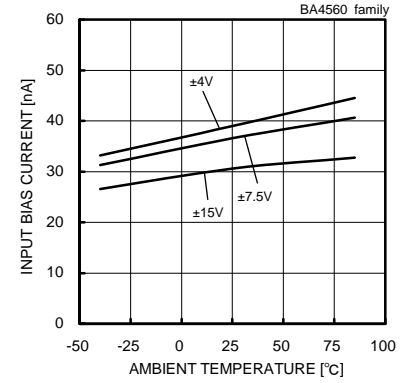

Fig. 56

Input Bias Current - Ambient Temperature

(Vicm=0[V], Vout=0[V])

(*)The above data is ability value of sample, it is not guaranteed.

●Reference Data BA4560 family

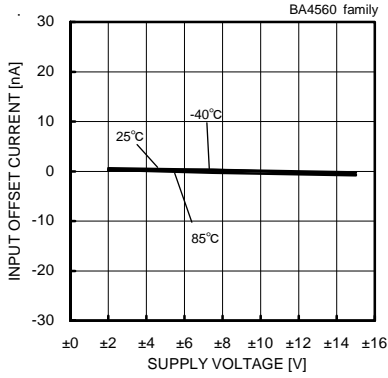

Fig. 57

Input Offset Current - Supply Voltage
(Vicm=0[V], Vout=0[V])

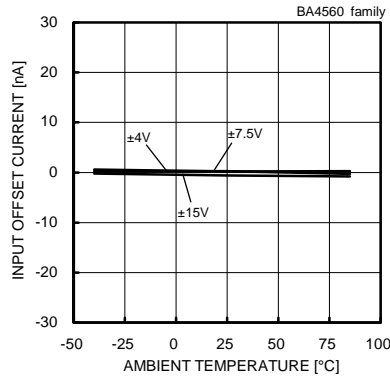

Fig. 58

Input Offset Current - Ambient Temperature
(Vicm=0[V], Vout=0[V])

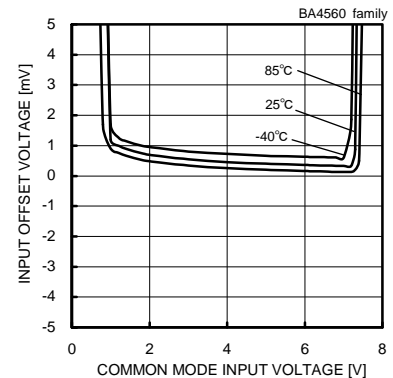

Fig. 59

Input Offset Voltage
-Common Mode Input Voltage
(VCC=8[V], Vout=4[V])

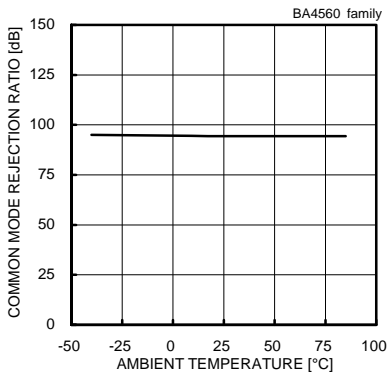

Fig. 60

Common Mode Rejection Ratio
- Ambient Temperature
(VCC/VEE=+15[V]/-15[V], Vicm=-12[V] to +12[V])

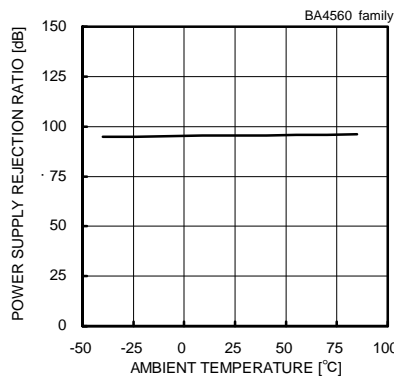

Fig. 61

Power Supply Rejection Ratio
- Ambient Temperature
(VCC/VEE=+4[V]/-4[V] to +15[V]/-15[V])

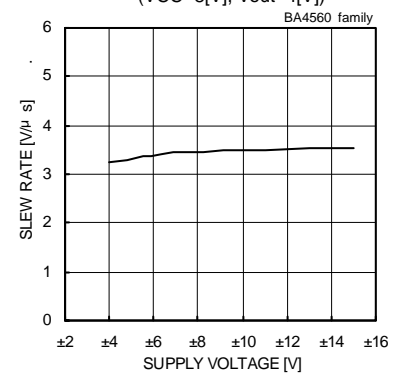

Fig. 62

Slew Rate - Supply Voltage (CL=100[pF],
RL=2[kΩ], Ta=25[°C])

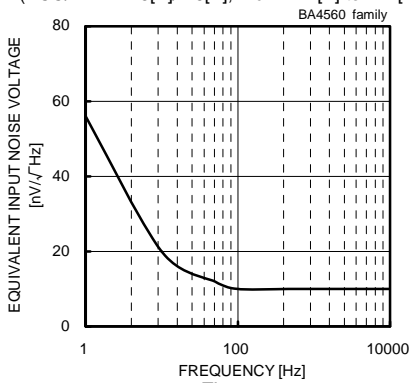

Fig. 63

Equivalent Input Noise Voltage - Frequency
(VCC/VEE=+15[V]/-15[V], Rs=100[Ω], Ta=25[°C])

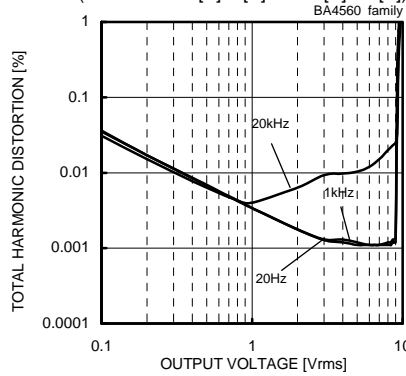

Fig. 64

Total Harmonic Distortion - Output Voltage
(VCC/VEE=+15[V]/-15[V], Av=20[dB],
RL=2[kΩ], 80[kHz]-LPF, Ta=25[°C])

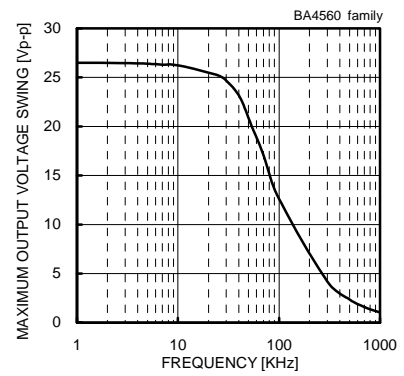

Fig. 65

Maximum Output Voltage Swing - Frequency
(VCC/VEE=+15[V]/-15[V], RL=2[kΩ], Ta=25[°C])

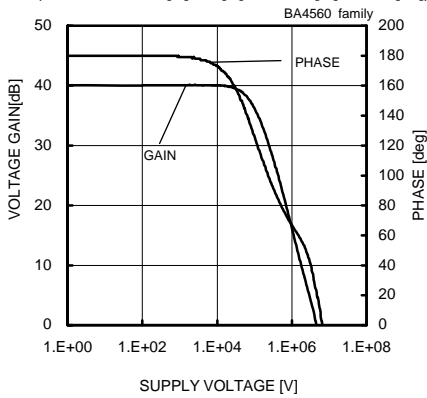

Fig. 66

Voltage Gain - Frequency (VCC/VEE=+15[V]/-15[V],
Av=40[dB], RL=2[kΩ], Ta=25[°C])

(*)The above data is ability value of sample, it is not guaranteed.

●Reference Data BA4560R family

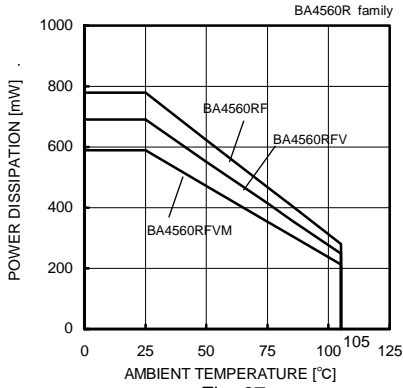

Fig. 67

Derating Curve

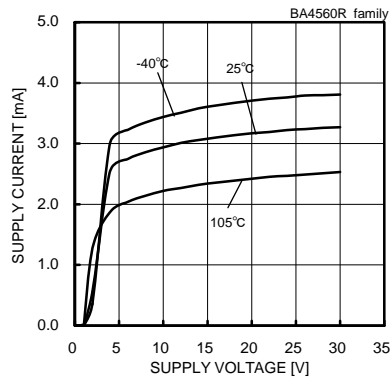

Fig. 68

Supply Current - Supply Voltage

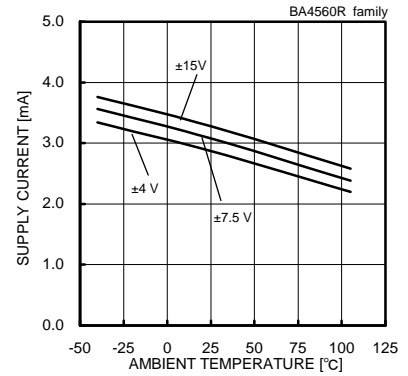

Fig. 69

Supply Current - Ambient Temperature

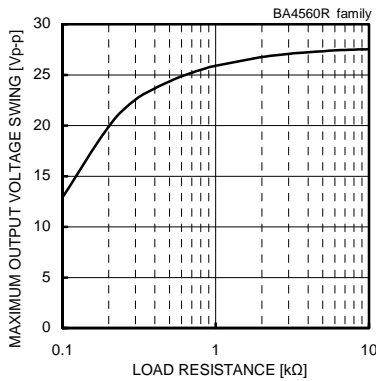

Fig. 70

Maximum Output Voltage Swing - Load Resistance

(VCC/VEE=±15[V]/-15[V], Ta=25[°C])

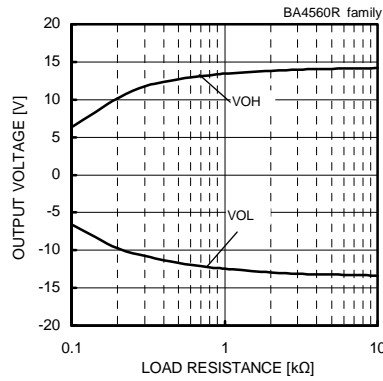

Fig. 71

Maximum Output Voltage - Load Resistance

(VCC/VEE=±15[V]/-15[V], Ta=25[°C])

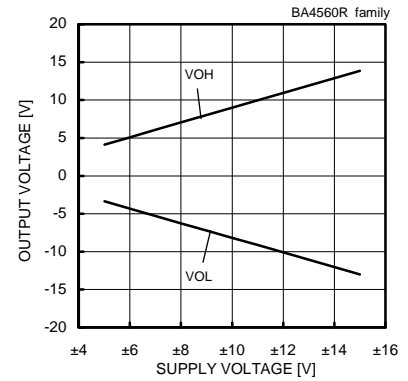

Fig. 72

Maximum Output Voltage - Supply Voltage

(RL=2[kΩ], Ta=25[°C])

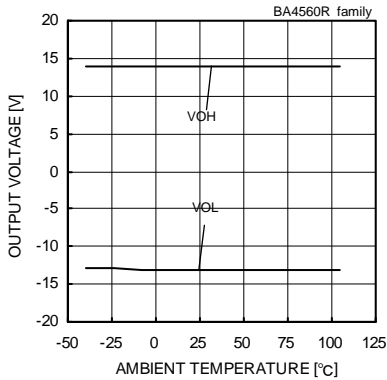

Fig. 73

Maximum Output Voltage - Ambient Temperature

(VCC/VEE=±15[V]/-15[V], RL=2[kΩ])

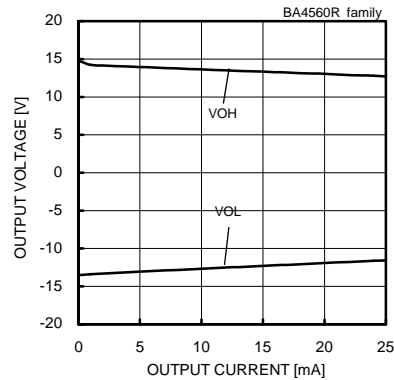

Fig. 74

Maximum Output Voltage - Output Current

(VCC/VEE=±15[V]/-15[V], Ta=25[°C])

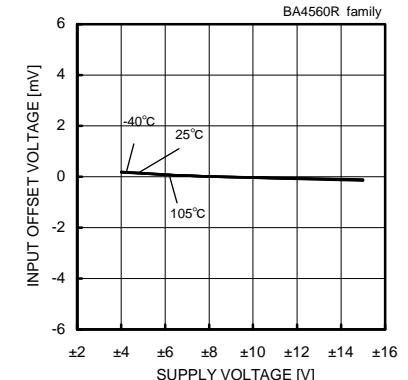

Fig. 75

Input Offset Voltage - Supply Voltage

(Vicm=0[V], Vout=0[V])

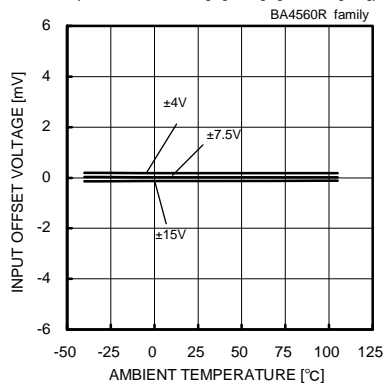

Fig. 76

Input Offset Voltage - Ambient Temperature

(Vicm=0[V], Vout=0[V])

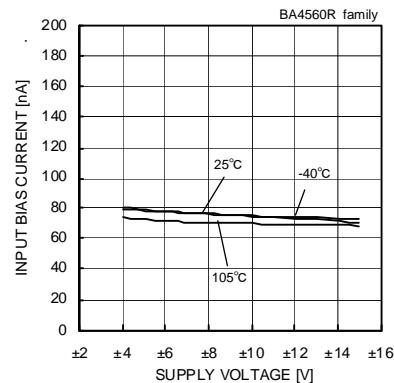

Fig. 77

Input Bias Current - Supply Voltage

(Vicm=0[V], Vout=0[V])

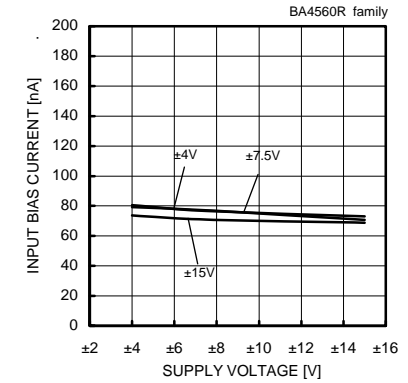

Fig. 78

Input Bias Current - Ambient Temperature

(Vicm=0[V], Vout=0[V])

(*)The above data is ability value of sample, it is not guaranteed.

●Reference Data BA4560R family

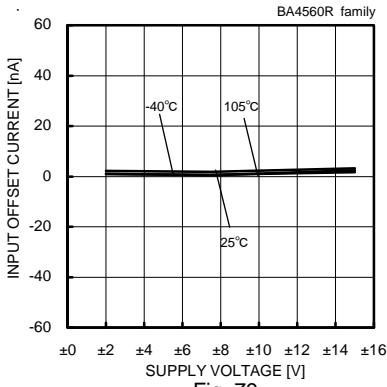

Fig. 79
Input Offset Current - Supply Voltage
(Vicm=0[V], Vout=0[V])

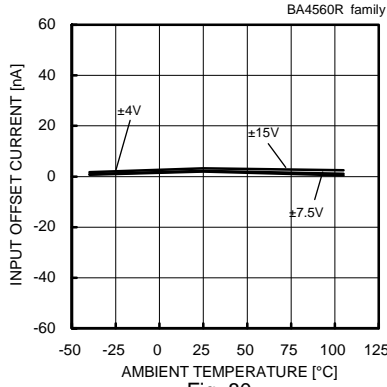

Fig. 80
Input Offset Current - Ambient Temperature
(Vicm=0[V], Vout=0[V])

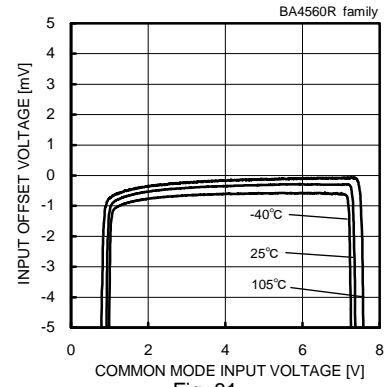

Fig. 81
Input Offset Voltage
-Common Mode Input Voltage
(VCC=8[V], Vout=4[V])

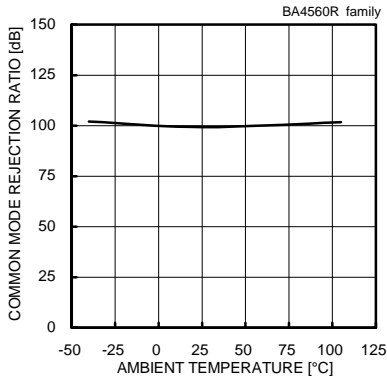

Fig. 82
Common Mode Rejection Ratio
- Ambient Temperature
(VCC/VEE=+15[V]/-15[V], Vicm=-12[V] to +12[V])

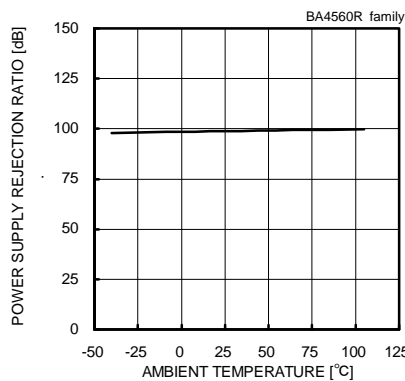

Fig. 83
Power Supply Rejection Ratio
- Ambient Temperature
(VCC/VEE=+4[V]/-4[V] to +15[V]/-15[V])

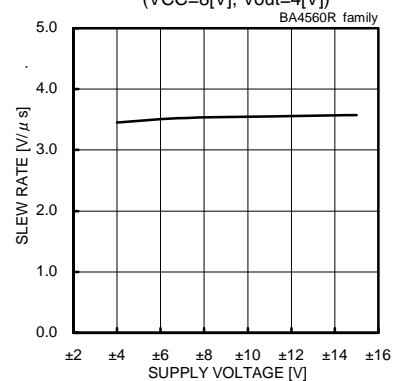

Fig. 84
Slew Rate - Supply Voltage
(CL=100[pF], RL=2[kΩ], Ta=25[°C])

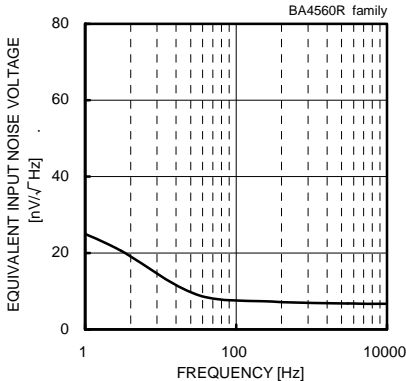

Fig. 85
Equivalent Input Noise Voltage - Frequency
(VCC/VEE=+15[V]/-15[V], Rs=100[Ω], Ta=25[°C])

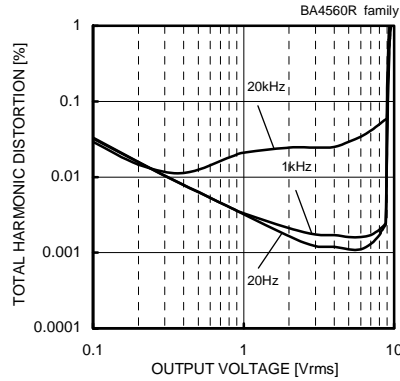

Fig. 86
Total Harmonic Distortion - Output Voltage
(VCC/VEE=+15[V]/-15[V], Av=20[dB],
RL=2[kΩ], 80[kHz]-LPF, Ta=25[°C])

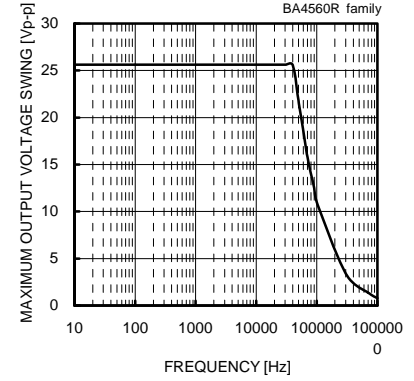

Fig. 87
Maximum Output Voltage Swing - Frequency
(VCC/VEE=+15[V]/-15[V], RL=2[kΩ], Ta=25[°C])

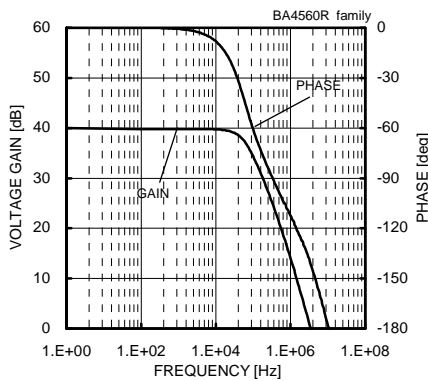

Fig. 88
Voltage Gain - Frequency (VCC/VEE=+15[V]/-15[V],
Av=40[dB], RL=2[kΩ], Ta=25[°C])

(*)The above data is ability value of sample, it is not guaranteed.

●Reference Data BA4564R family

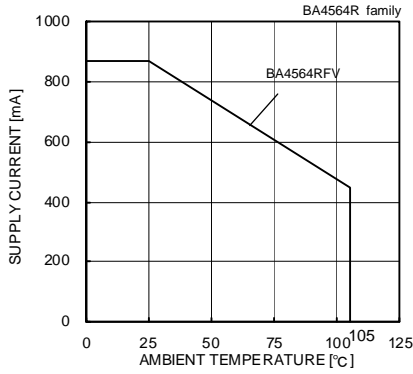

Fig. 89

Derating Curve

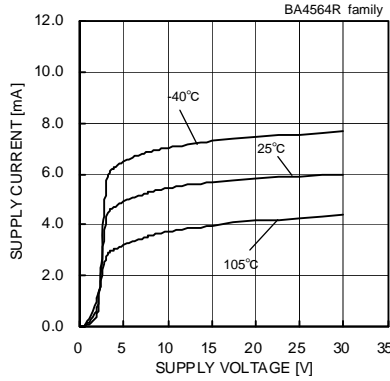

Fig. 90

Supply Current - Supply Voltage

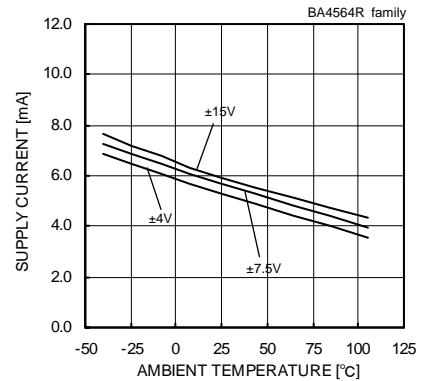

Fig. 91

Supply Current - Ambient Temperature

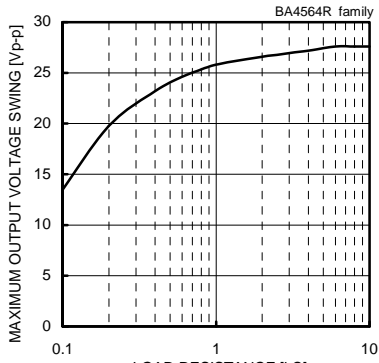

Fig. 92

Maximum Output Voltage Swing - Load Resistance
(VCC/VEE=±15[V]/-15[V], Ta=25[°C])

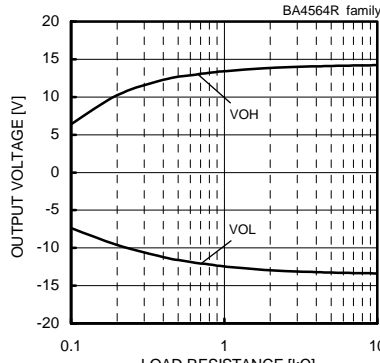

Fig. 93

Maximum Output Voltage - Load Resistance
(VCC/VEE=±15[V]/-15[V], Ta=25[°C])

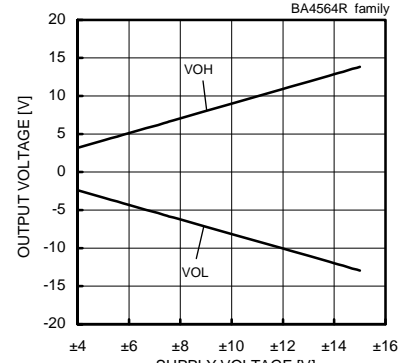

Fig. 94

Maximum Output Voltage - Supply Voltage
(RL=2[kΩ], Ta=25[°C])

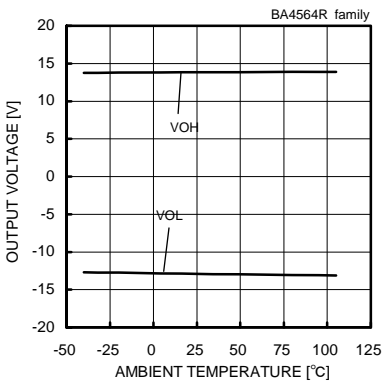

Fig. 95

Maximum Output Voltage - Ambient Temperature
(VCC/VEE=±15[V]/-15[V], RL=2[kΩ])

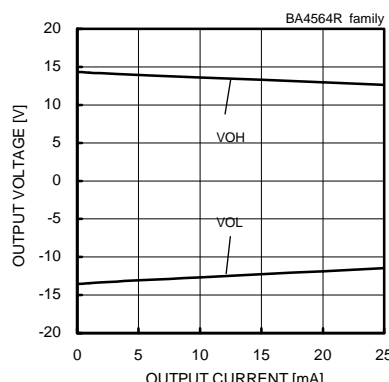

Fig. 96

Maximum Output Voltage - Output Current
(VCC/VEE=±15[V]/-15[V], Ta=25[°C])

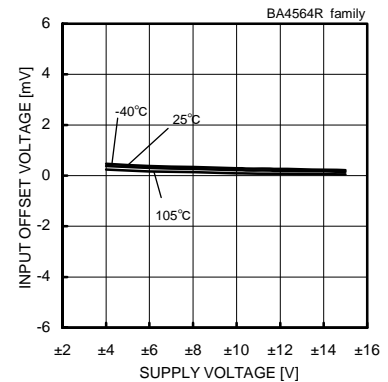

Fig. 97

Input Offset Voltage - Supply Voltage
(Vicm=0[V], Vout=0[V])

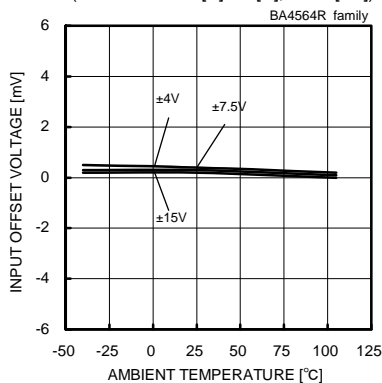

Fig. 98

Input Offset Voltage - Ambient Temperature
(Vicm=0[V], Vout=0[V])

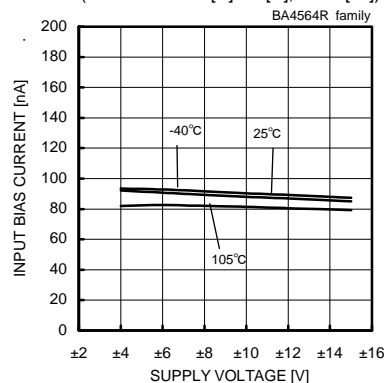

Fig. 99

Input Bias Current - Supply Voltage
(Vicm=0[V], Vout=0[V])

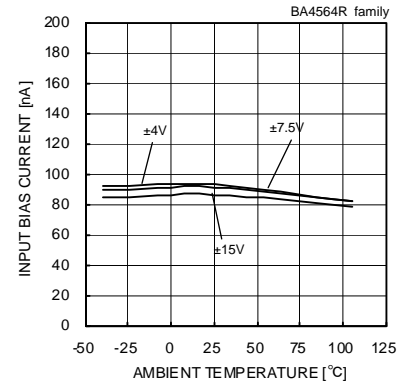

Fig. 100

Input Bias Current - Ambient Temperature
(Vicm=0[V], Vout=0[V])

(*)The above data is ability value of sample, it is not guaranteed.

●Reference Data BA4564R family

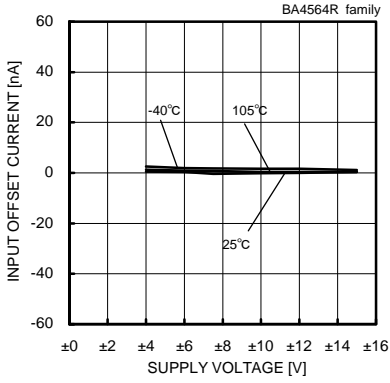

Fig. 101
Input Offset Current - Supply Voltage
($V_{icm}=0[V]$, $V_{out}=0[V]$)

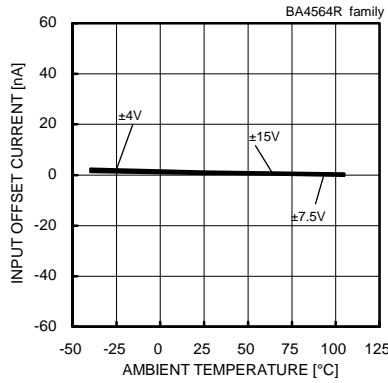

Fig. 102
Input Offset Current - Ambient Temperature
($V_{icm}=0[V]$, $V_{out}=0[V]$)

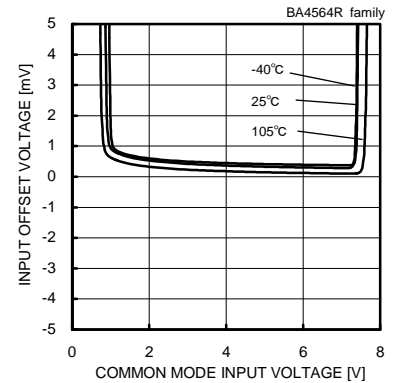

Fig. 103
Input Offset Voltage
- Common Mode Input Voltage
($V_{CC}=8[V]$, $V_{out}=4[V]$)

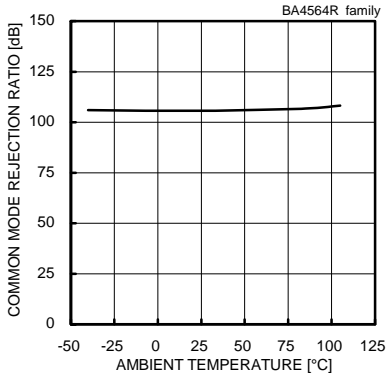

Fig. 104
Common Mode Rejection Ratio
- Ambient Temperature
($V_{CC}/V_{EE}=+15[V]/-15[V]$, $V_{icm}=-12[V]$ to $+12[V]$)

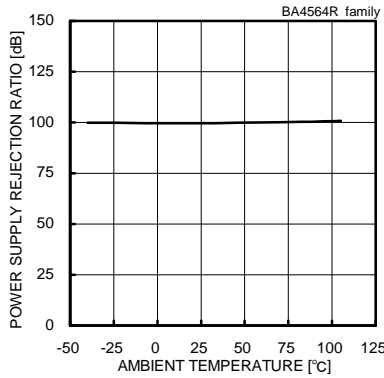

Fig. 105
Power Supply Rejection Ratio
- Ambient Temperature
($V_{CC}/V_{EE}=+4[V]/-4[V]$ to $+15[V]/-15[V]$)

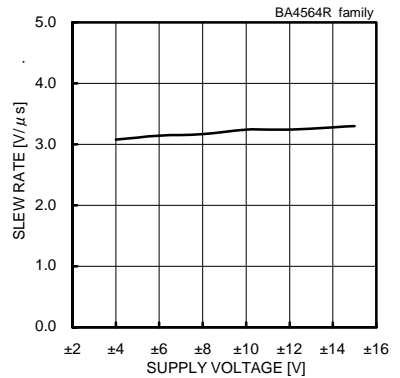

Fig. 106
Slew Rate - Supply Voltage
($C_L=100[pF]$, $R_L=2[kΩ]$, $T_a=25[°C]$)

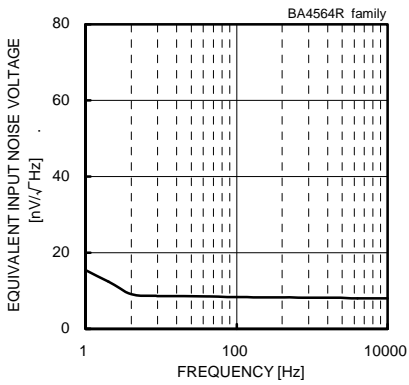

Fig. 107
Equivalent Input Noise Voltage - Frequency
($V_{CC}/V_{EE}=+15[V]/-15[V]$, $R_s=100[Ω]$, $T_a=25[°C]$)

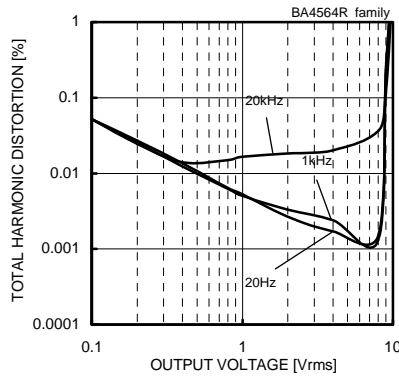

Fig. 108
Total Harmonic Distortion - Output Voltage
($V_{CC}/V_{EE}=+15[V]/-15[V]$, $A_v=20[dB]$,
 $R_L=2[kΩ]$, $80[kHz]$ -LPF, $T_a=25[°C]$)

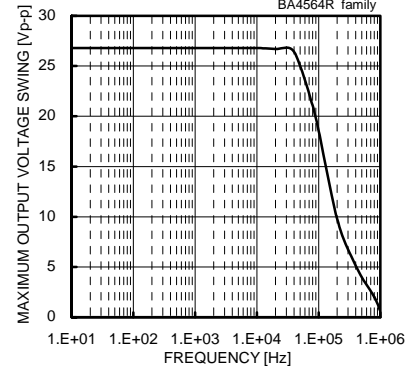

Fig. 109
Maximum Output Voltage Swing - Frequency
($V_{CC}/V_{EE}=+15[V]/-15[V]$, $R_L=2[kΩ]$, $T_a=25[°C]$)

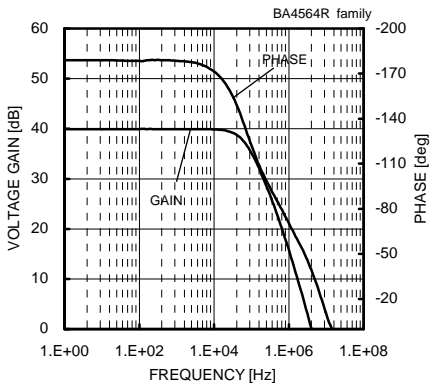

Fig. 110
Voltage Gain - Frequency
($V_{CC}/V_{EE}=+15[V]/-15[V]$, $A_v=40[dB]$, $R_L=2[kΩ]$, $T_a=25[°C]$)

(*)The above data is ability value of sample, it is not guaranteed.

●Reference Data BA4580R family

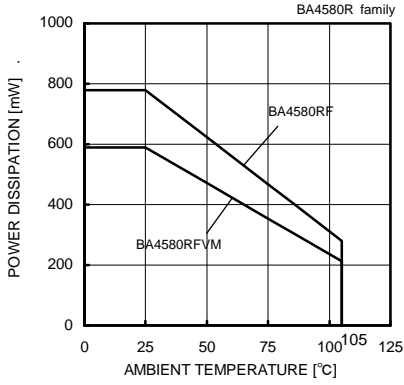

Fig. 111

Derating Curve

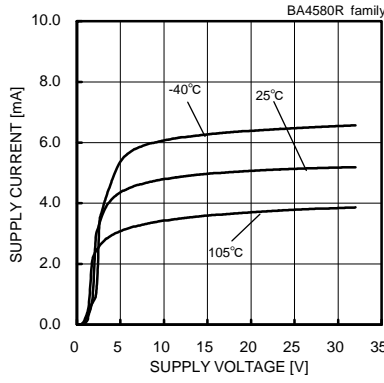

Fig. 112

Supply Current - Supply Voltage

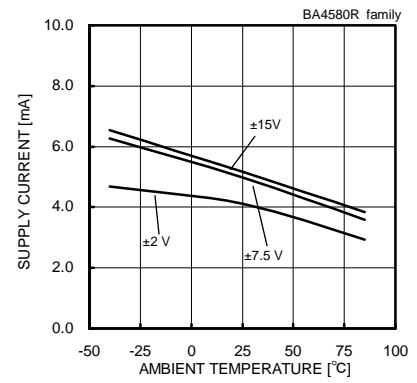

Fig. 113

Supply Current - Ambient Temperature

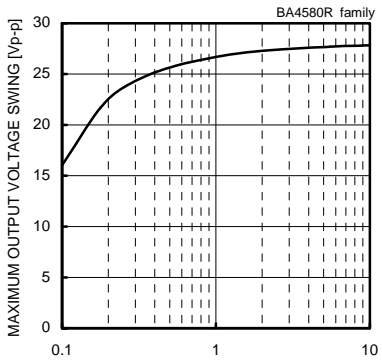

Fig. 114

Maximum Output Voltage Swing - Load Resistance
(VCC/VEE=±15[V]/-15[V], Ta=25[°C])

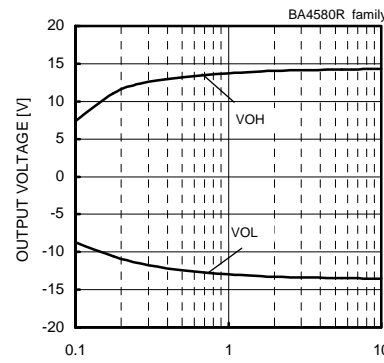

Fig. 115

Maximum Output Voltage - Load Resistance
(VCC/VEE=±15[V]/-15[V], Ta=25[°C])

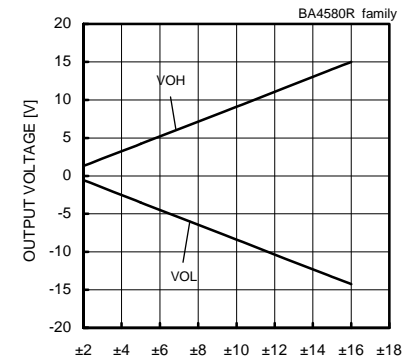

Fig. 116

Maximum Output Voltage - Supply Voltage
(RL=2[kΩ], Ta=25[°C])

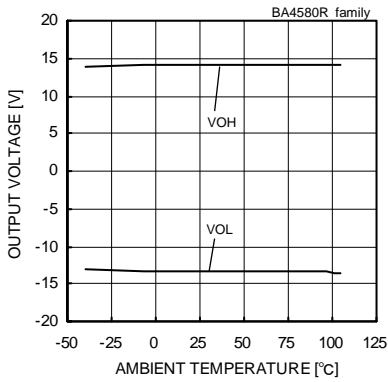

Fig. 117

Maximum Output Voltage - Ambient Temperature
(VCC/VEE=±15[V]/-15[V], RL=2[kΩ])

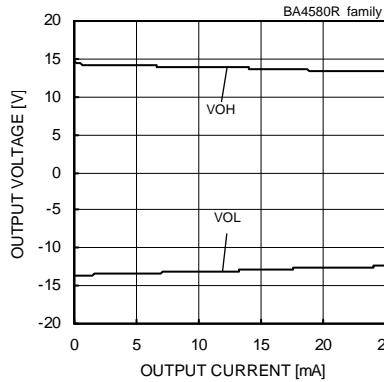

Fig. 118

Maximum Output Voltage - Ambient Temperature
(VCC/VEE=±15[V]/-15[V], Ta=25[°C])

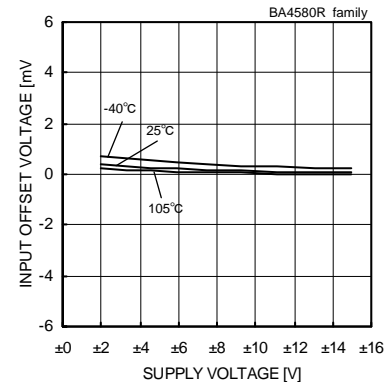

Fig. 119

Input Offset Voltage - Supply Voltage
(Vcm=0[V], Vout=0[V])

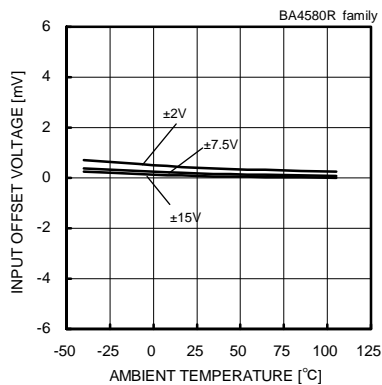

Fig. 120

Input Offset Voltage - Ambient Temperature
(Vcm=0[V], Vout=0[V])

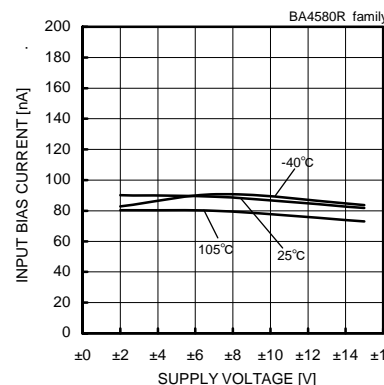

Fig. 121

Input Bias Current - Supply Voltage
(Vcm=0[V], Vout=0[V])

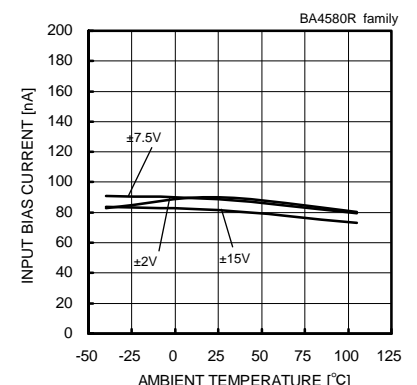

Fig. 122

Input Bias Current - Ambient Temperature
(Vcm=0[V], Vout=0[V])

(*)The above data is ability value of sample, it is not guaranteed.

●Reference Data BA4580R family

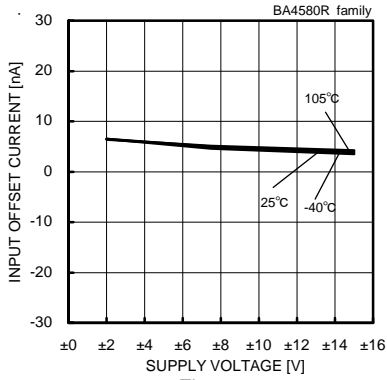

Fig. 123
Input Offset Current - Supply Voltage
($V_{icm}=0[V]$, $V_{out}=0[V]$)

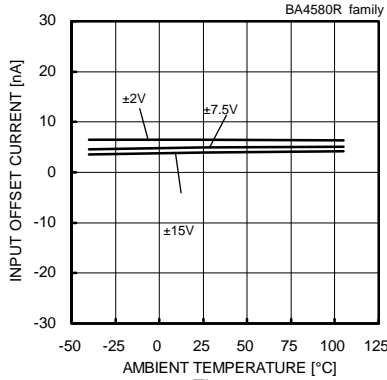

Fig. 124
Input Offset Current - Ambient Temperature
($V_{icm}=0[V]$, $V_{out}=0[V]$)

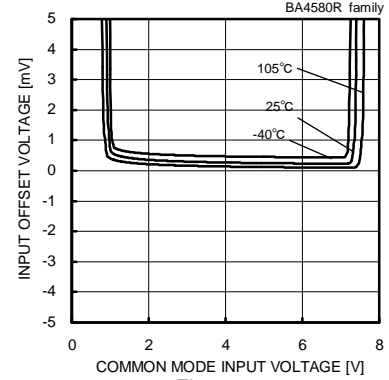

Fig. 125
Input Offset Voltage
- Common Mode Input Voltage
($V_{CC}=8[V]$, $V_{out}=4[V]$)

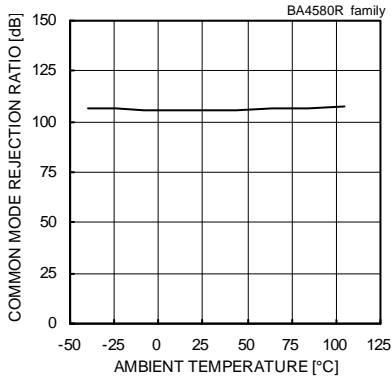

Fig. 126
Common Mode Rejection Ratio
- Ambient Temperature
($V_{CC}/V_{EE}=+15[V]/-15[V]$, $V_{icm}=-12[V]$ to $+12[V]$)

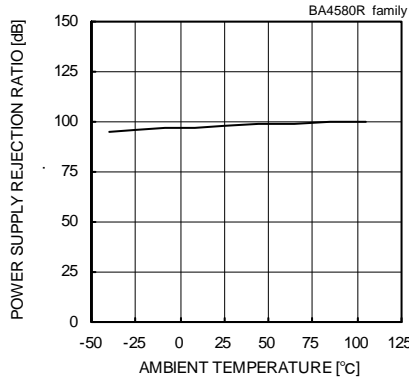

Fig. 127
Power Supply Rejection Ratio
- Ambient Temperature
($V_{CC}/V_{EE}=+2[V]/-2[V]$ to $+15[V]/-15[V]$)

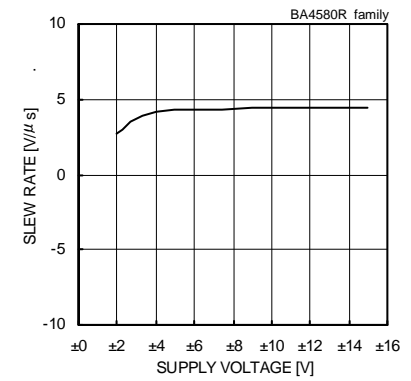

Fig. 128
Slew Rate - Supply Voltage
($C_L=100[pF]$, $R_L=2[k\Omega]$, $T_a=25[^\circ C]$)

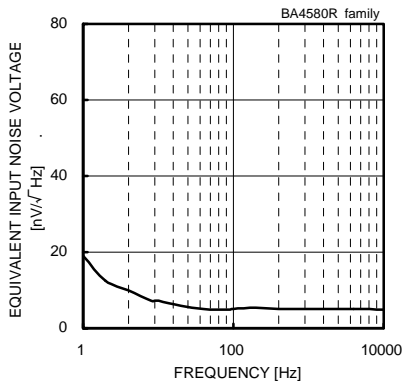

Fig. 129
Equivalent Input Noise Voltage - Frequency
($V_{CC}/V_{EE}=+15[V]/-15[V]$, $R_s=100[\Omega]$, $T_a=25[^\circ C]$)

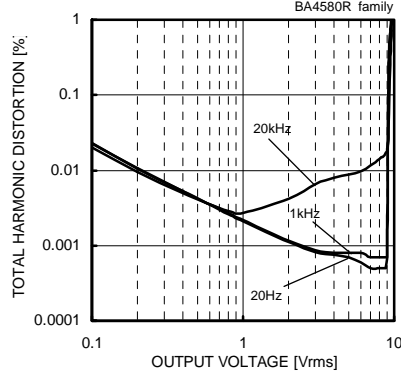

Fig. 130
Total Harmonic Distortion - Output Voltage
($V_{CC}/V_{EE}=+15[V]/-15[V]$, $A_v=20[dB]$,
 $R_L=2[k\Omega]$, $80[kHz]$ -LPF, $T_a=25[^\circ C]$)

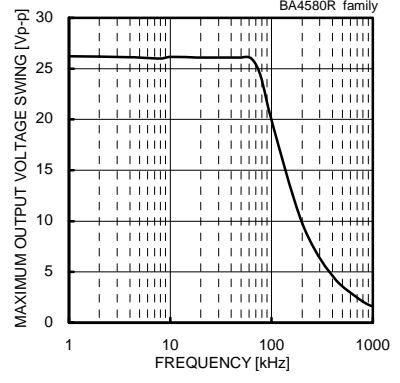

Fig. 131
Maximum Output Voltage Swing - Frequency
($V_{CC}/V_{EE}=+15[V]/-15[V]$, $R_L=2[k\Omega]$, $T_a=25[^\circ C]$)

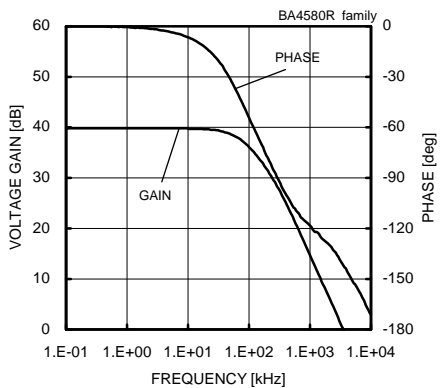

Fig. 132
Voltage Gain - Frequency
($V_{CC}/V_{EE}=+15[V]/-15[V]$, $A_v=40[dB]$, $R_L=2[k\Omega]$, $T_a=25[^\circ C]$)

(*The above data is ability value of sample, it is not guaranteed.

●Reference Data BA4584 family

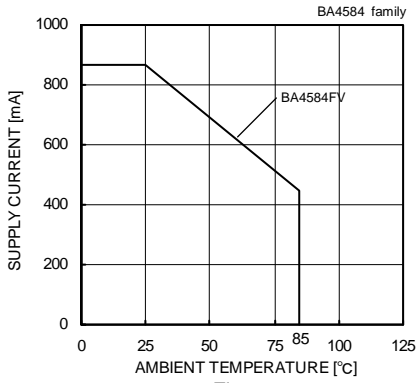

Fig. 133
Derating Curve

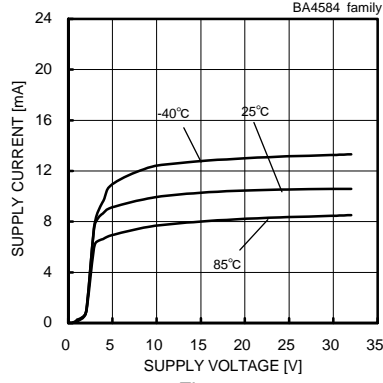

Fig. 134
Supply Current - Supply Voltage

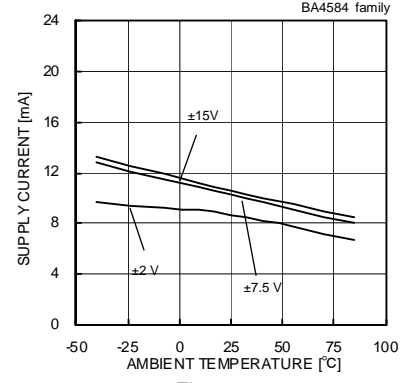

Fig. 135
Supply Current - Ambient Temperature

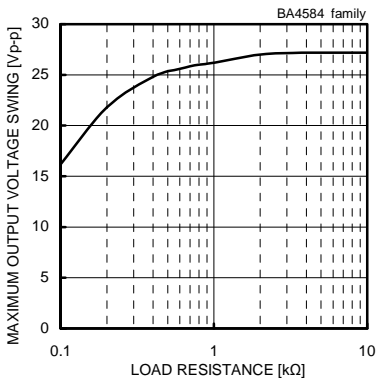

Fig. 136
Maximum Output Voltage Swing
- Load Resistance
(VCC/VEE=+15[V]/-15[V], Ta=25[°C])

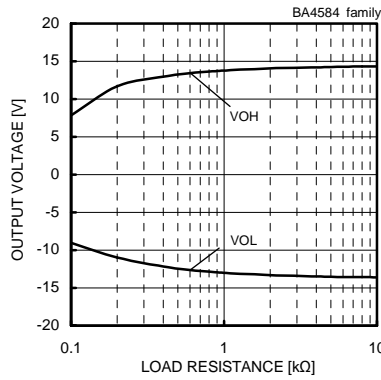

Fig. 137
Maximum Output Voltage
- Load Resistance
(VCC/VEE=+15[V]/-15[V], Ta=25[°C])

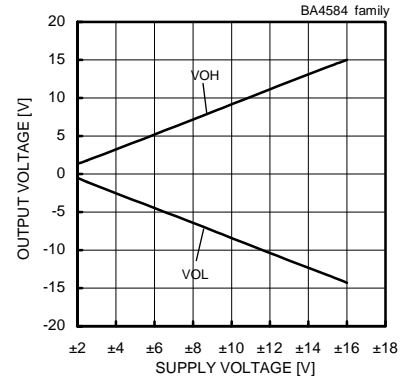

Fig. 138
Maximum Output Voltage
- Supply Voltage
(RL=2[kΩ], Ta=25[°C])

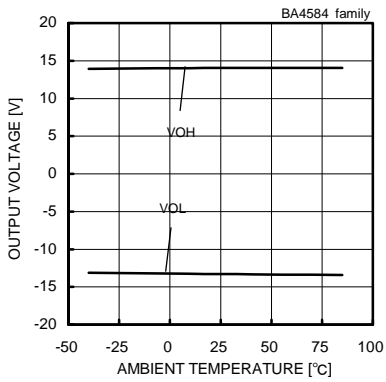

Fig. 139
Maximum Output Voltage
- Ambient Temperature
(VCC/VEE=+15[V]/-15[V], RL=2[kΩ])

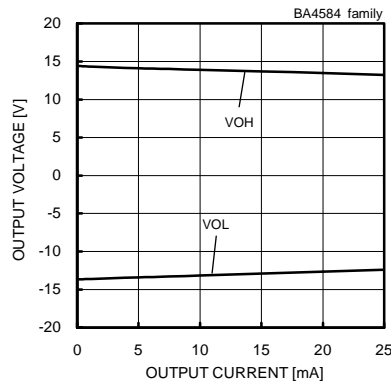

Fig. 140
Maximum Output Voltage
- Output Current
(VCC/VEE=+15[V]/-15[V], Ta=25[°C])

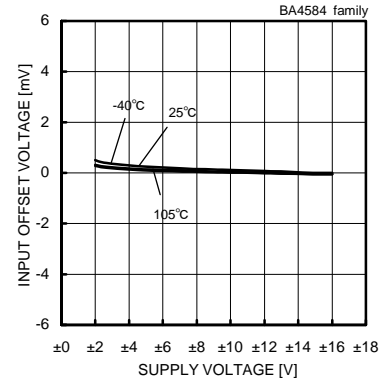

Fig. 141
Input Offset Voltage - Supply Voltage
(Vicm=0[V], Vout=0[V])

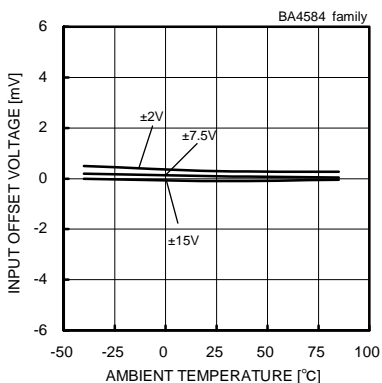

Fig. 142
Input Offset Voltage - Ambient Temperature
(Vicm=0[V], Vout=0[V])

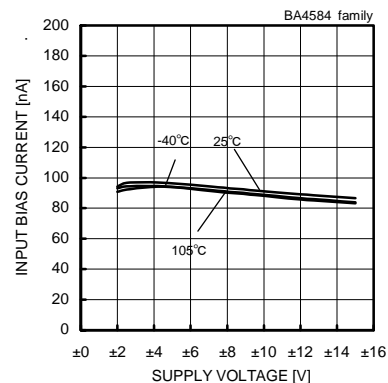

Fig. 143
Input Bias Current - Supply Voltage
(Vicm=0[V], Vout=0[V])

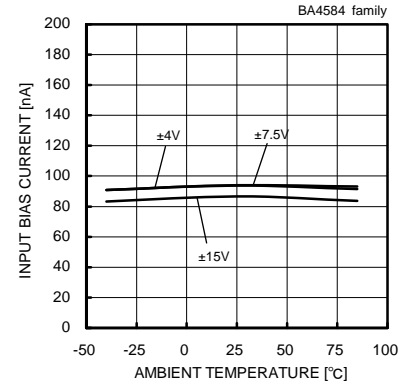

Fig. 144
Input Bias Current - Ambient Temperature
(Vicm=0[V], Vout=0[V])

(*)The above data is ability value of sample, it is not guaranteed.

●Reference Data BA4584 family

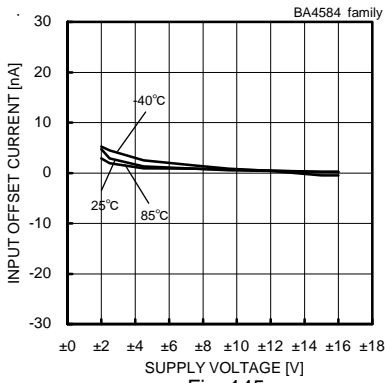

Fig. 145
Input Offset Current - Supply Voltage
($V_{icm}=0[V]$, $V_{out}=0[V]$)

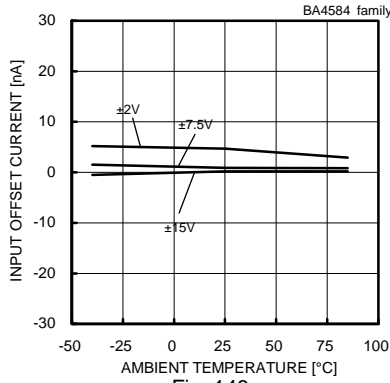

Fig. 146
Input Offset Current - Ambient Temperature
($V_{icm}=0[V]$, $V_{out}=0[V]$)

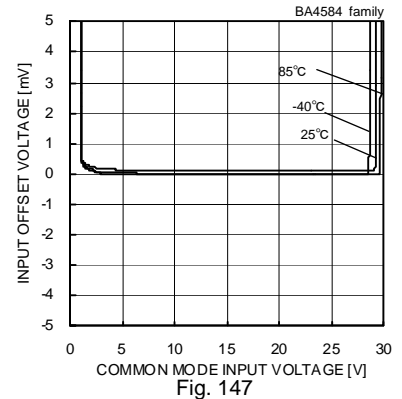

Fig. 147
Input Offset Voltage
- Common Mode Input Voltage
($V_{CC}=8[V]$, $V_{out}=4[V]$)

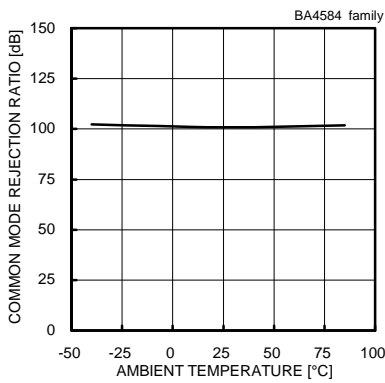

Fig. 148
Common Mode Rejection Ratio
- Ambient Temperature
($V_{CC}/V_{EE}=\pm 15[V]/-15[V]$, $V_{icm}=-12[V]$ to $+12[V]$)

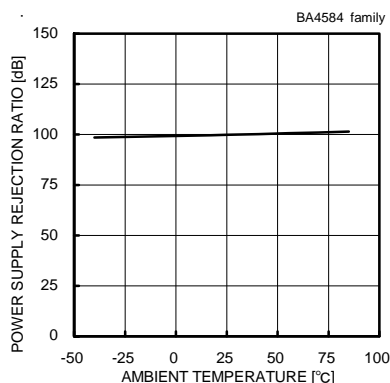

Fig. 149
Power Supply Rejection Ratio
- Ambient Temperature
($V_{CC}/V_{EE}=\pm 2[V]/-2[V]$ to $\pm 15[V]/-15[V]$)

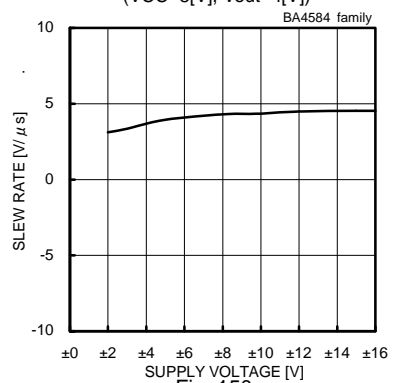

Fig. 150
Slew Rate - Supply Voltage
($C_L=100[pF]$, $R_L=2[k\Omega]$, $T_a=25[^\circ C]$)

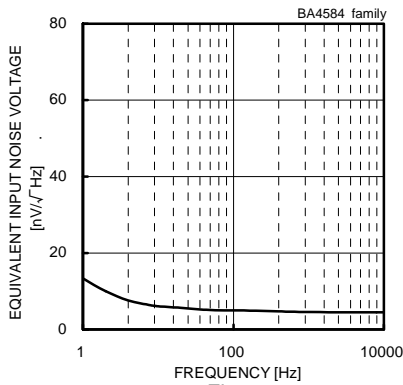

Fig. 151
Equivalent Input Noise Voltage - Frequency
($V_{CC}/V_{EE}=\pm 15[V]/-15[V]$, $R_s=100[\Omega]$, $T_a=25[^\circ C]$)

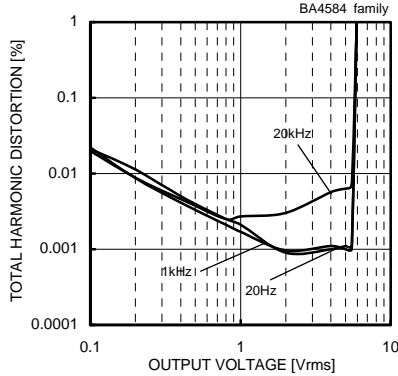

Fig. 152
Total Harmonic Distortion - Output Voltage
($V_{CC}/V_{EE}=\pm 15[V]/-15[V]$, $A_v=20[dB]$,
 $R_L=2[k\Omega]$, $80[kHz]$ -LPF, $T_a=25[^\circ C]$)

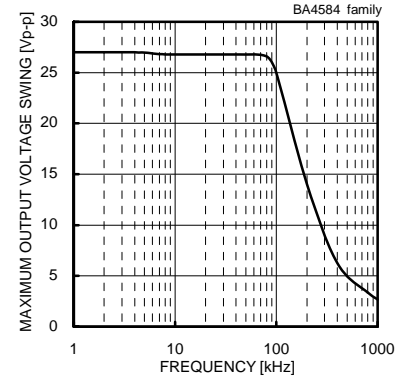

Fig. 153
Maximum Output Voltage Swing - Frequency
($V_{CC}/V_{EE}=\pm 15[V]/-15[V]$, $R_L=2[k\Omega]$, $T_a=25[^\circ C]$)

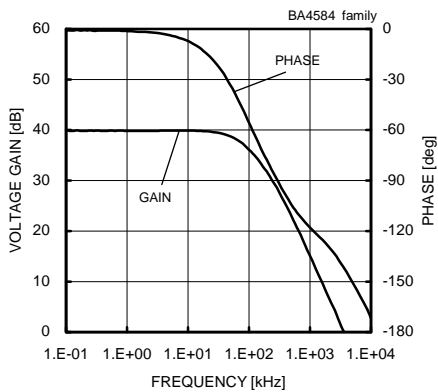

Fig. 154
Voltage Gain - Frequency
($V_{CC}/V_{EE}=\pm 15[V]/-15[V]$, $A_v=40[dB]$, $R_L=2[k\Omega]$, $T_a=25[^\circ C]$)

(*)The above data is ability value of sample, it is not guaranteed.

●Reference Data BA4584R family

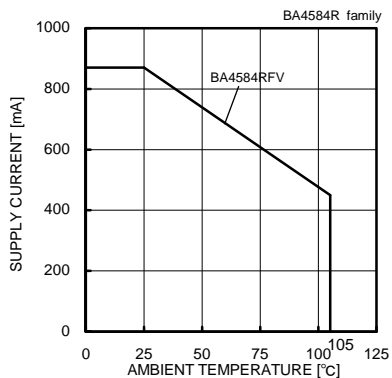

Fig. 155

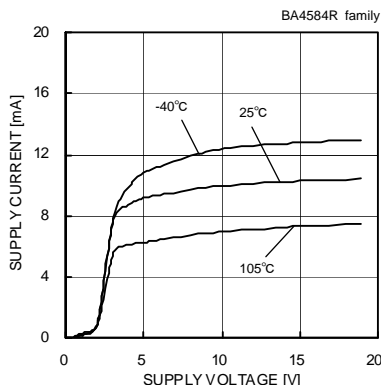

Fig. 156

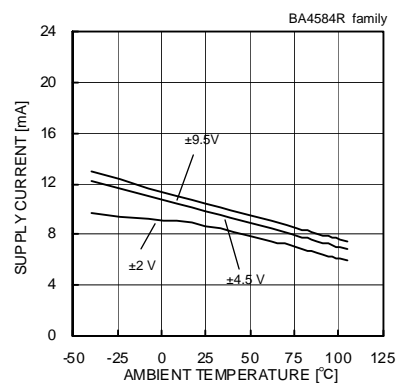

Fig. 157

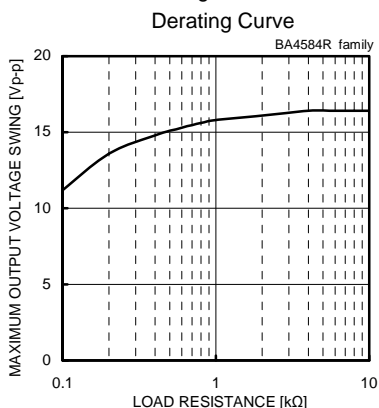

Fig. 158
Maximum Output Voltage Swing
- Load Resistance
(VCC/VEE=+9.5[V]/-9.5[V], Ta=25[°C])

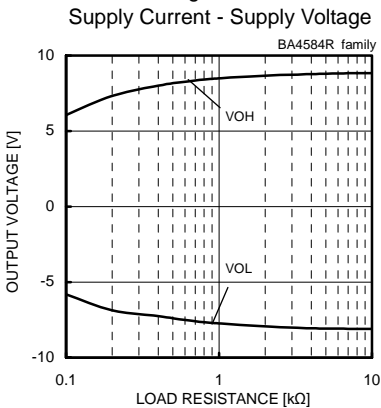

Fig. 159
Maximum Output Voltage
- Load Resistance
(VCC/VEE=+9.5[V]/-9.5[V], Ta=25[°C])

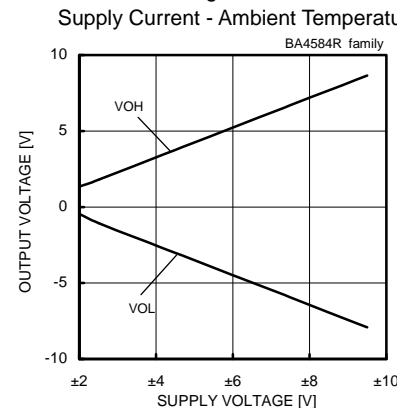

Fig. 160
Maximum Output Voltage
- Supply Voltage
(RL=2[kΩ], Ta=25[°C])

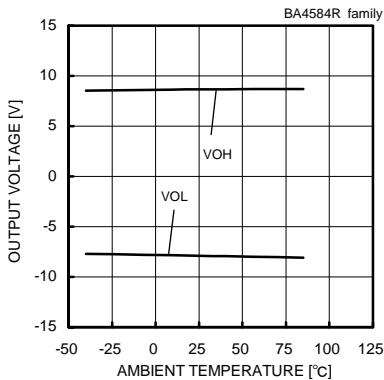

Fig. 161
Maximum Output Voltage
- Ambient Temperature
(VCC/VEE=+9.5[V]/-9.5[V], RL=2[kΩ])

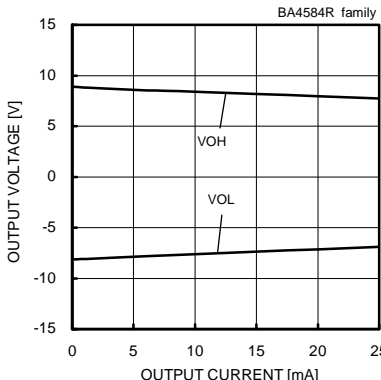

Fig. 162
Maximum Output Voltage
- Output Current
(VCC/VEE=+9.5[V]/-9.5[V], Ta=25[°C])

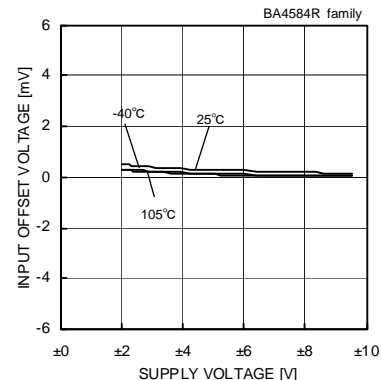

Fig. 163

Input Offset Voltage - Supply Voltage
(Vicm=0[V], Vout=0[V])

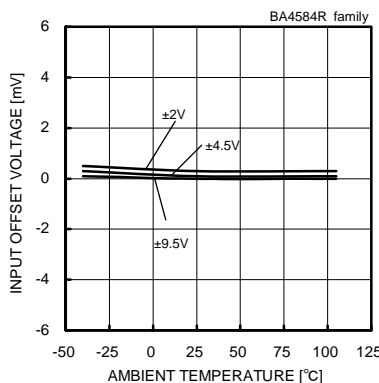

Fig. 164
Input Offset Voltage - Ambient Temperature
(Vicm=0[V], Vout=0[V])

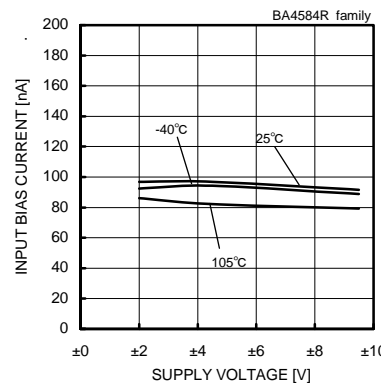

Fig. 165
Input Bias Current - Supply Voltage
(Vicm=0[V], Vout=0[V])

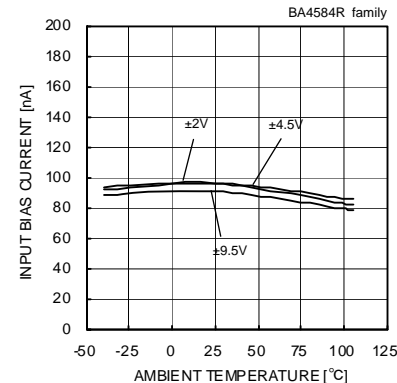

Fig. 166
Input Bias Current - Ambient Temperature
(Vicm=0[V], Vout=0[V])

(*)The above data is ability value of sample, it is not guaranteed.

●Reference Data BA4584R family

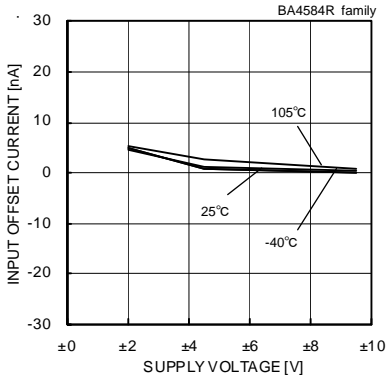

Fig. 167
Input Offset Current - Supply Voltage
(Vicm=0[V], Vout=0[V])

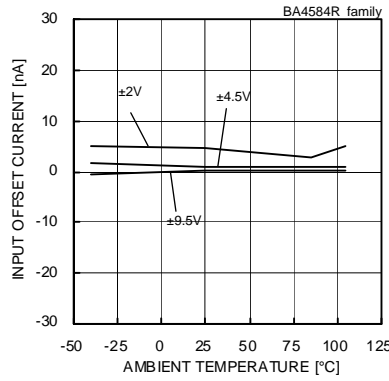

Fig. 168
Input Offset Current - Ambient Temperature
(Vicm=0[V], Vout=0[V])

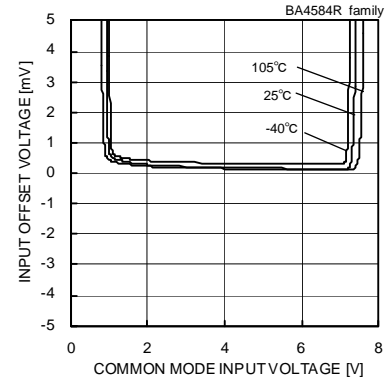

Fig. 169
Input Offset Voltage
- Common Mode Input Voltage
(VCC=8[V], Vout=4[V])

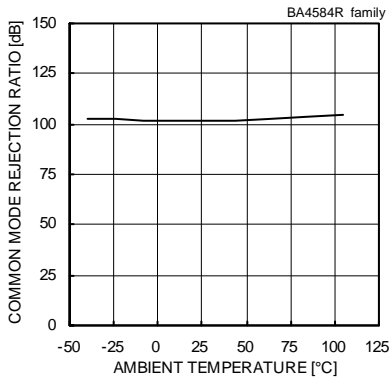

Fig. 170
Common Mode Rejection Ratio
- Ambient Temperature
(VCC/VEE=+9.5[V]/-9.5[V], Vicm=-12[V] to +12[V])

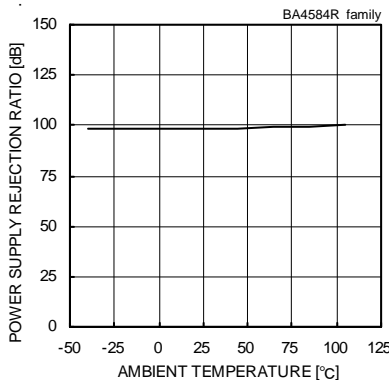

Fig. 171
Power Supply Rejection Ratio
- Ambient Temperature
(VCC/VEE=+2[V]/-2[V] to +9.5[V]/-9.5[V])

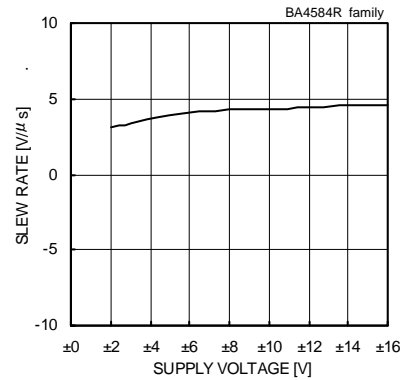

Fig. 172
Slew Rate - Supply Voltage
(CL=100[pF], RL=2[kΩ], Ta=25[°C])

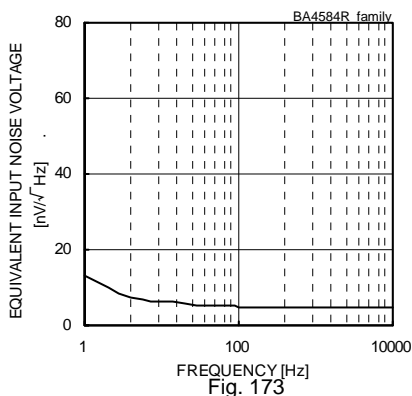

Fig. 173
Equivalent Input Noise Voltage - Frequency
(VCC/VEE=+9.5[V]/-9.5[V], Rs=100[Ω], Ta=25[°C])

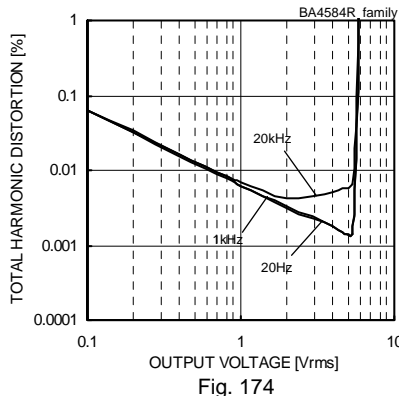

Fig. 174
Total Harmonic Distortion - Output Voltage
(VCC/VEE=+9.5[V]/-9.5[V], Av=20[dB],
RL=2[kΩ], 80[kHz]-LPF, Ta=25[°C])

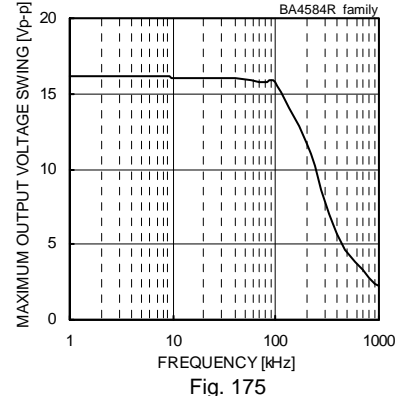

Fig. 175
Maximum Output Voltage Swing - Frequency
(VCC/VEE=+9.5[V]/-9.5[V], RL=2[kΩ], Ta=25[°C])

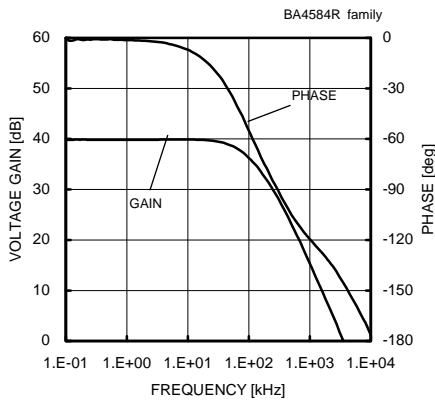

Fig. 176
Voltage Gain - Frequency
(VCC/VEE=+9.5[V]/-9.5[V], Av=40[dB], RL=2[kΩ], Ta=25[°C])

(*The above data is ability value of sample, it is not guaranteed.)

●Reference Data BA8522R family

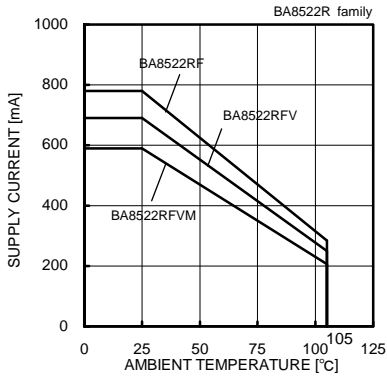

Fig. 177
Derating Curve

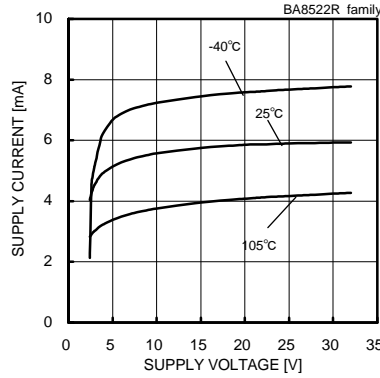

Fig. 178
Supply Current - Supply Voltage

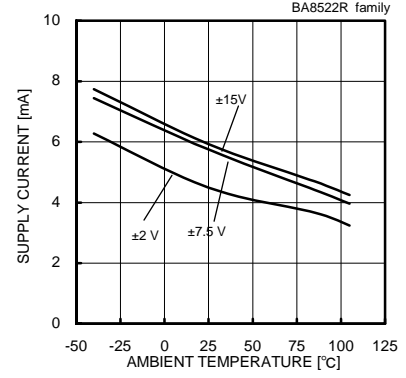

Fig. 179
Supply Current - Ambient Temperature

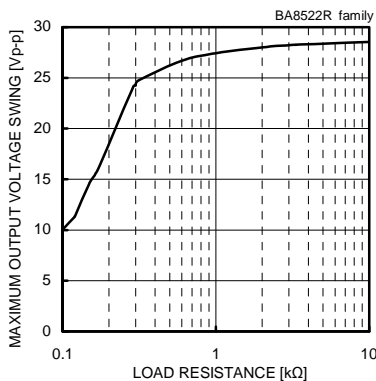

Fig. 180
Maximum Output Voltage Swing
- Load Resistance
(VCC/VEE=±15[V]/-15[V], Ta=25[°C])

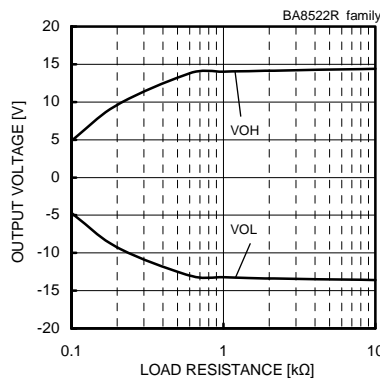

Fig. 181
Maximum Output Voltage
- Load Resistance
(VCC/VEE=±15[V]/-15[V], Ta=25[°C])

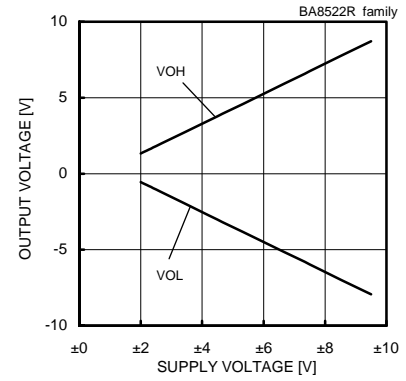

Fig. 182
Maximum Output Voltage
- Supply Voltage
(RL=2[kΩ], Ta=25[°C])

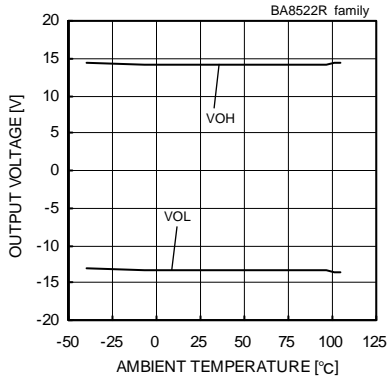

Fig. 183
Maximum Output Voltage
- Ambient Temperature
(VCC/VEE=±15[V]/-15[V], RL=2[kΩ])

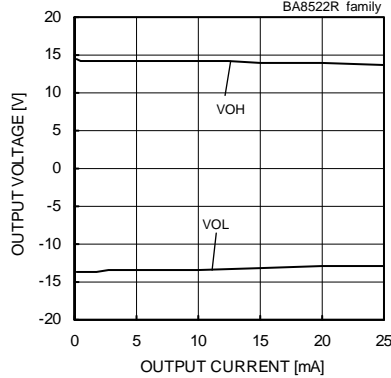

Fig. 184
Maximum Output Voltage
- Output Current
(VCC/VEE=±15[V]/-15[V], Ta=25[°C])

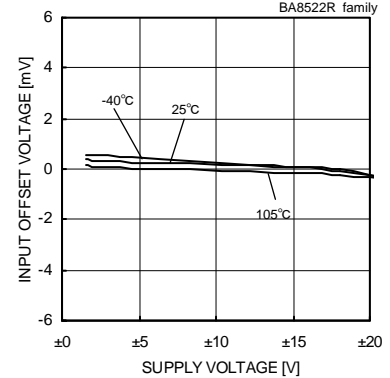

Fig. 185
Input Offset Voltage - Supply Voltage
(Vcm=0[V], Vout=0[V])

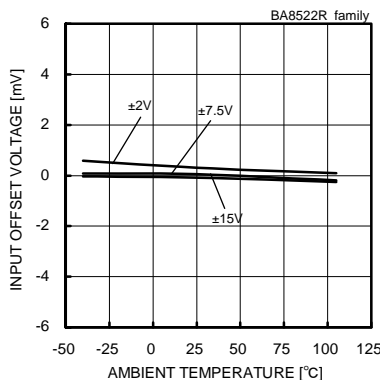

Fig. 186
Input Offset Voltage - Ambient Temperature
(Vcm=0[V], Vout=0[V])

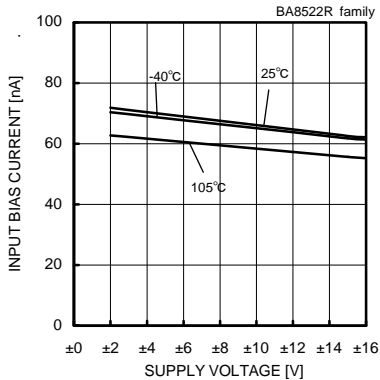

Fig. 187
Input Bias Current - Supply Voltage
(Vcm=0[V], Vout=0[V])

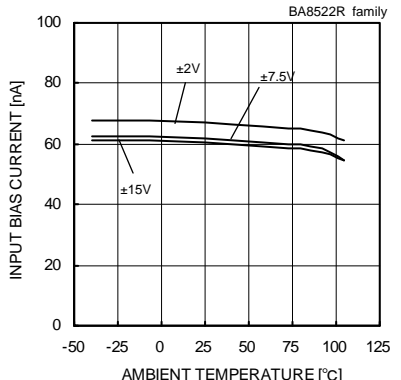

Fig. 188
Input Bias Current - Ambient Temperature
(Vcm=0[V], Vout=0[V])

(*)The above data is ability value of sample, it is not guaranteed.

●Reference Data BA8522R family

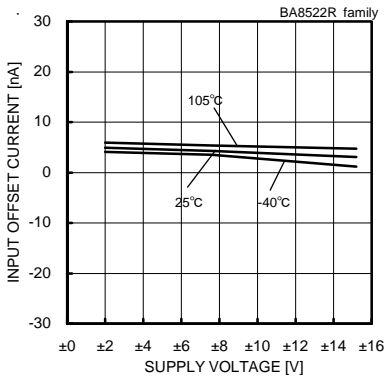

Fig. 189
Input Offset Current - Supply Voltage
($V_{icm}=0[V]$, $V_{out}=0[V]$)

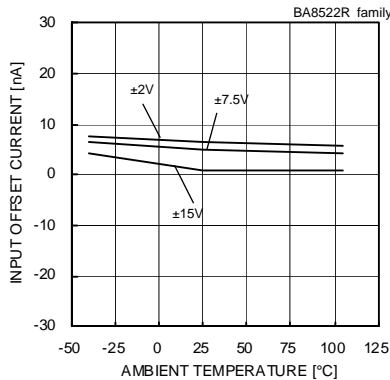

Fig. 190
Input Offset Current - Ambient Temperature
($V_{icm}=0[V]$, $V_{out}=0[V]$)

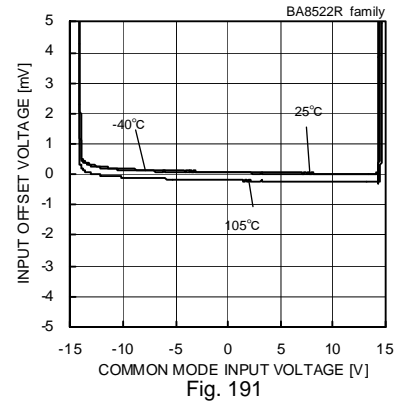

Fig. 191
Input Offset Voltage
- Common Mode Input Voltage
($V_{CC}=8[V]$, $V_{out}=4[V]$)

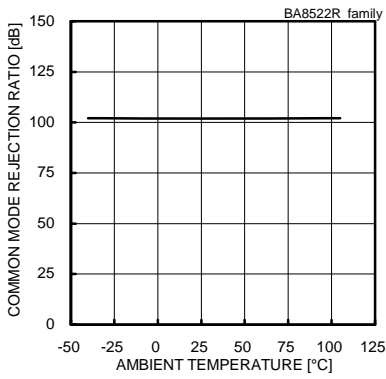

Fig. 192
Common Mode Rejection Ratio
- Ambient Temperature
($V_{CC}/V_{EE}=+15[V]/-15[V]$, $V_{icm}=-12[V]$ to $+12[V]$)

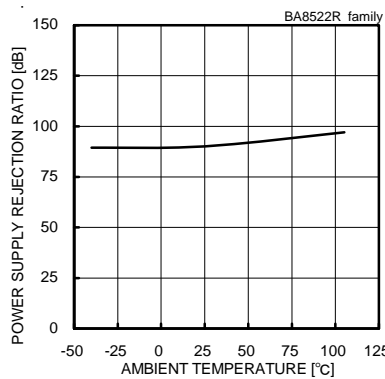

Fig. 193
Power Supply Rejection Ratio
- Ambient Temperature
($V_{CC}/V_{EE}=+2[V]/-2[V]$ to $+15[V]/-15[V]$)

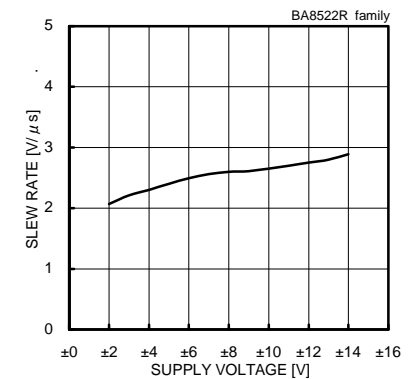

Fig. 194
Slew Rate - Supply Voltage
($C_L=100[pF]$, $R_L=2[k\Omega]$, $T_a=25[^\circ C]$)

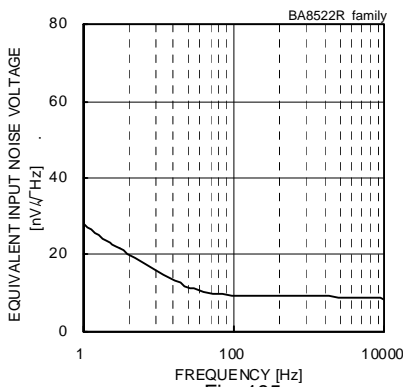

Fig. 195
Equivalent Input Noise Voltage - Frequency
($V_{CC}/V_{EE}=+15[V]/-15[V]$, $R_s=100[\Omega]$, $T_a=25[^\circ C]$)

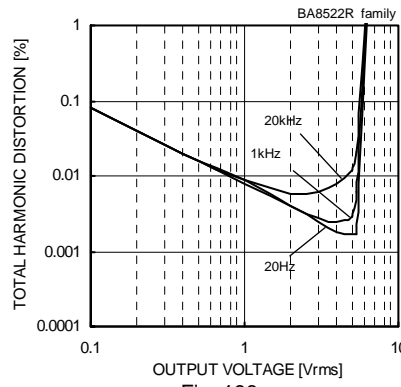

Fig. 196
Total Harmonic Distortion - Output Voltage
($V_{CC}/V_{EE}=+15[V]/-15[V]$, $A_v=20[dB]$, $R_L=2[k\Omega]$, $80[kHz]$ -LPF, $T_a=25[^\circ C]$)

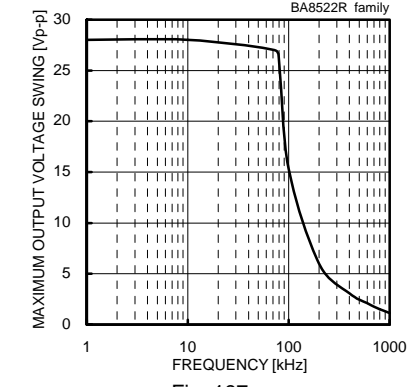

Fig. 197
Maximum Output Voltage Swing - Frequency
($V_{CC}/V_{EE}=+15[V]/-15[V]$, $R_L=2[k\Omega]$, $T_a=25[^\circ C]$)

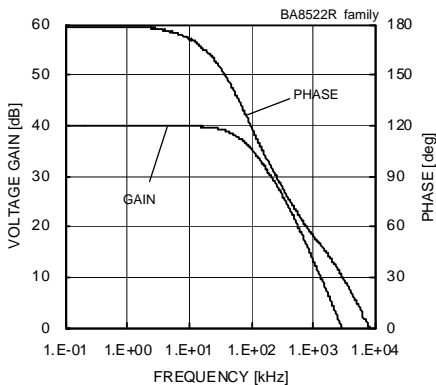

Fig. 198
Voltage Gain - Frequency
($V_{CC}/V_{EE}=+15[V]/-15[V]$, $A_v=40[dB]$, $R_L=2[k\Omega]$, $T_a=25[^\circ C]$)

(*The above data is ability value of sample, it is not guaranteed.)

● Reference Data BA15218 family

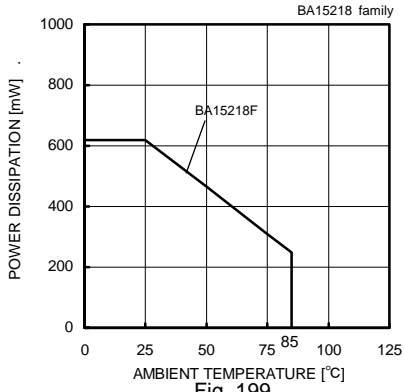

Fig. 199

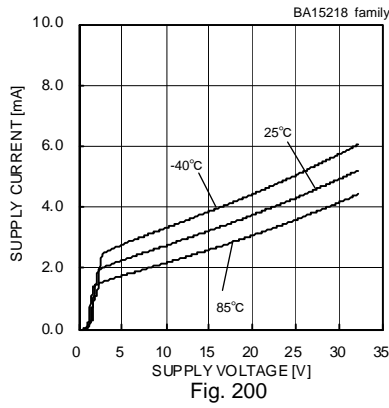

Fig. 200

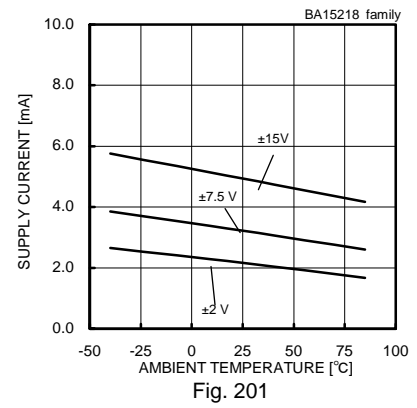

Fig. 201

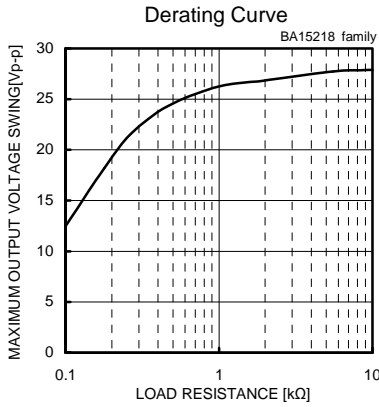

Fig. 202

Maximum Output Voltage Swing - Load Resistance
(VCC/VEE=+15[V]/-15[V], Ta=25°C)

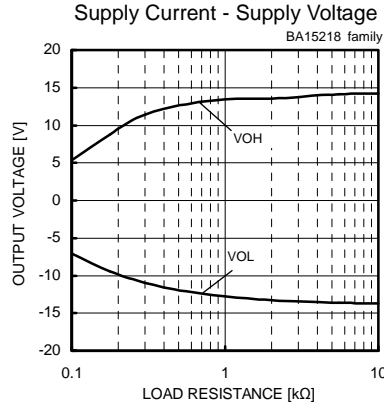

Fig. 203

Maximum Output Voltage - Load Resistance
(VCC/VEE=+15[V]/-15[V], Ta=25°C)

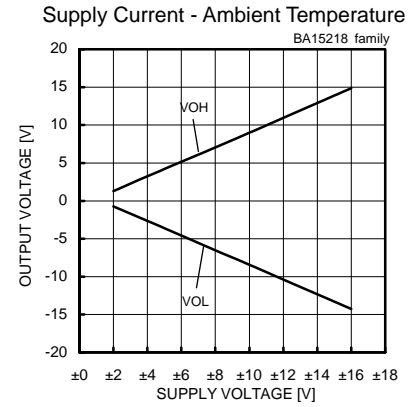

Fig. 204

Maximum Output Voltage - Supply Voltage
(RL=2[kΩ], Ta=25°C)

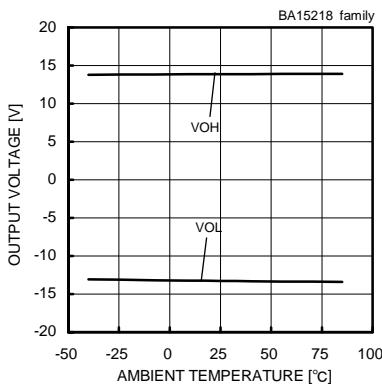

Fig. 205

Maximum Output Voltage - Ambient Temperature
(VCC/VEE=+15[V]/-15[V], RL=2[kΩ])

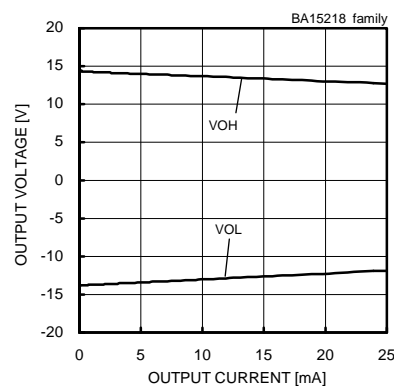

Fig. 206

Maximum Output Voltage - Output Current
(VCC/VEE=+15[V]/-15[V], Ta=25°C)

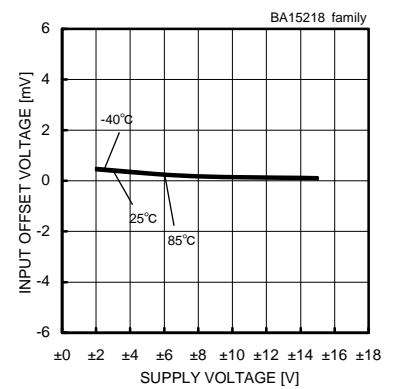

Fig. 207

Input Offset Voltage - Supply Voltage
(Vicm=0[V], Vout=0[V])

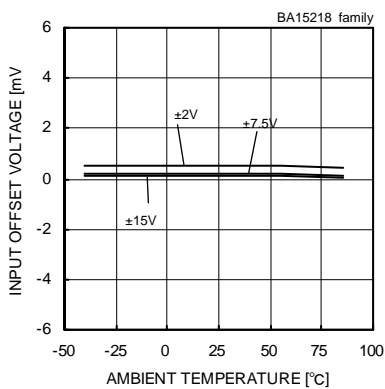

Fig. 208

Input Offset Voltage - Ambient Temperature
(Vicm=0[V], Vout=0[V])

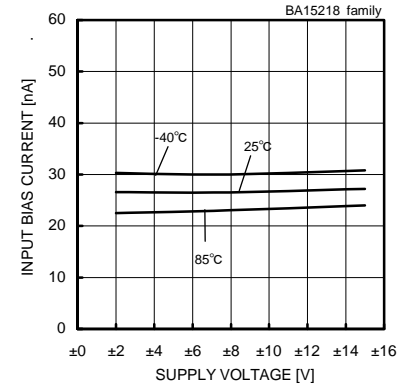

Fig. 209

Input Bias Current - Supply Voltage
(Vicm=0[V], Vout=0[V])

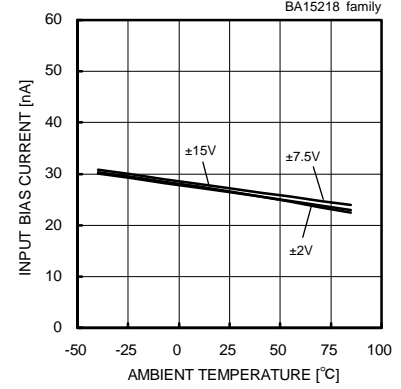

Fig. 210

Input Bias Current - Ambient Temperature
(Vicm=0[V], Vout=0[V])

(*)The above data is ability value of sample, it is not guaranteed.

●Reference Data BA15218 family

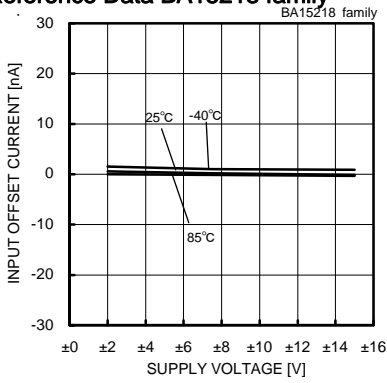

Fig. 211
Input Offset Current - Supply Voltage
($V_{icm}=0[V]$, $V_{out}=0[V]$)

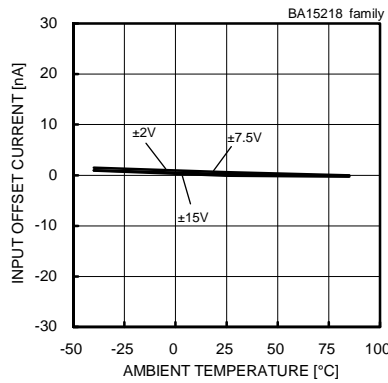

Fig. 212
Input Offset Current - Ambient Temperature
($V_{icm}=0[V]$, $V_{out}=0[V]$)

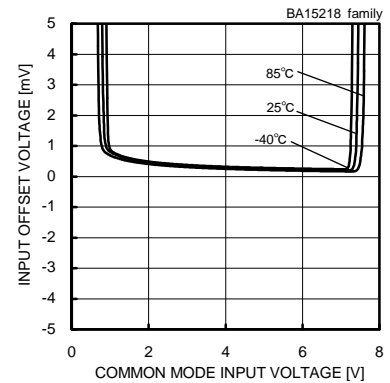

Fig. 213
Input Offset Voltage
- Common Mode Input Voltage
($V_{CC}=8[V]$, $V_{out}=4[V]$)

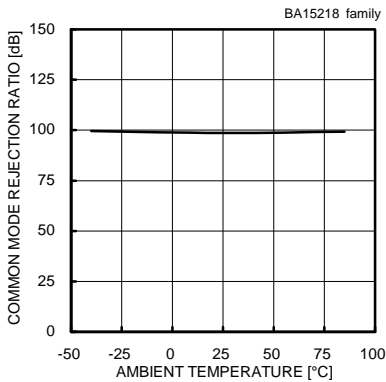

Fig. 214
Common Mode Rejection Ratio
- Ambient Temperature
($V_{CC}/V_{EE}=+15[V]/-15[V]$, $V_{icm}=-12[V]$ to $+12[V]$)

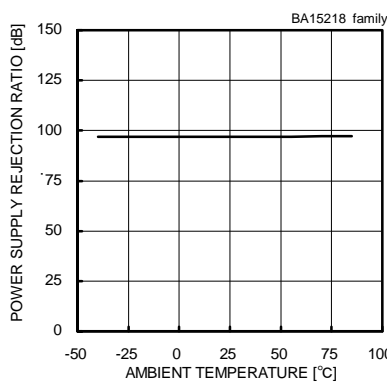

Fig. 215
Power Supply Rejection Ratio
- Ambient Temperature
($V_{CC}/V_{EE}=+2[V]/-2[V]$ to $+15[V]/-15[V]$)

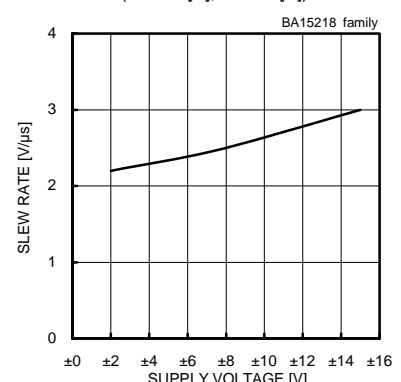

Fig. 216
Slew Rate - Supply Voltage
($C_L=100[pF]$, $R_L=2[k\Omega]$, $T_a=25[^\circ C]$)

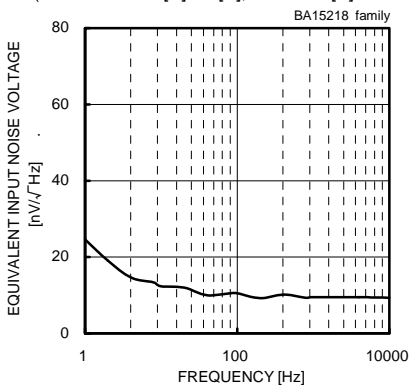

Fig. 217
Equivalent Input Noise Voltage - Frequency
($V_{CC}/V_{EE}=+15[V]/-15[V]$, $R_s=100[\Omega]$, $T_a=25[^\circ C]$)

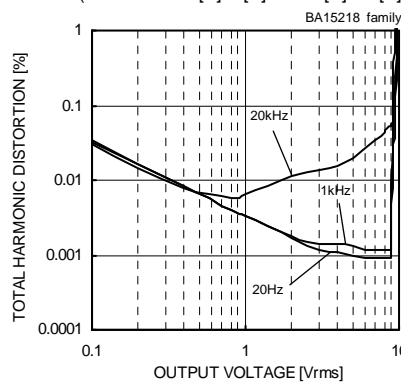

Fig. 218
Total Harmonic Distortion - Output Voltage
($V_{CC}/V_{EE}=+15[V]/-15[V]$, $A_v=20[dB]$, $R_L=2[k\Omega]$, 80kHz-LPF, $T_a=25[^\circ C]$)

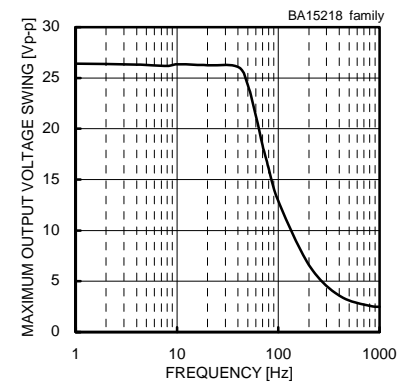

Fig. 219
Maximum Output Voltage Swing - Frequency
($V_{CC}/V_{EE}=+15[V]/-15[V]$, $R_L=2[k\Omega]$, $T_a=25[^\circ C]$)

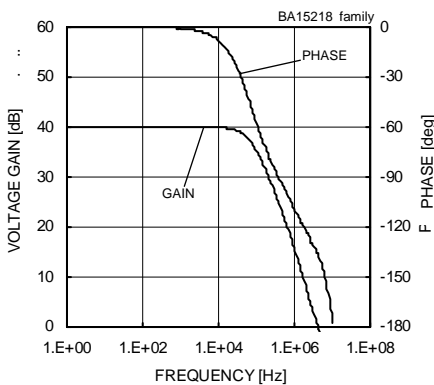

Fig. 220
Voltage Gain - Frequency
($V_{CC}/V_{EE}=+15[V]/-15[V]$, $A_v=40[dB]$, $R_L=2[k\Omega]$, $T_a=25[^\circ C]$)

(*)The above data is ability value of sample, it is not guaranteed.

●Reference Data BA14741 family

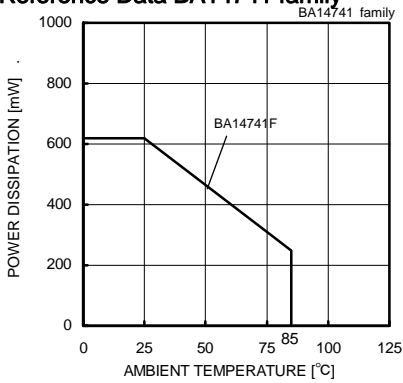

Fig. 221

Derating Curve

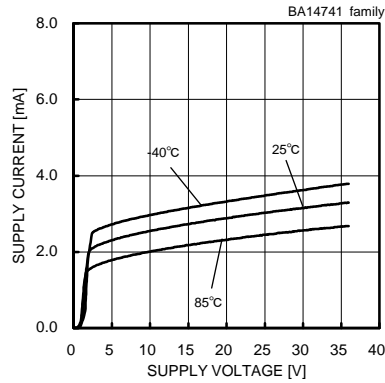

Fig. 222

Supply Current - Supply Voltage

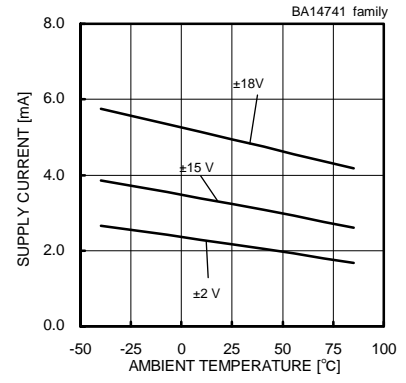

Fig. 223

Supply Current - Ambient Temperature

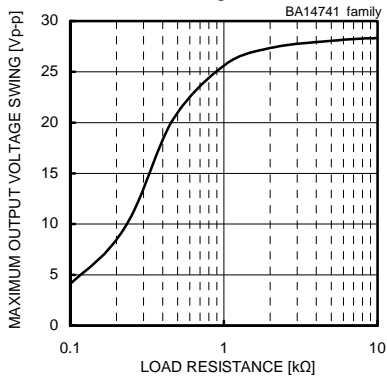

Fig. 224

Maximum Output Voltage Swing - Load Resistance
(VCC/VEE=+15[V]/-15[V], Ta=25[°C])

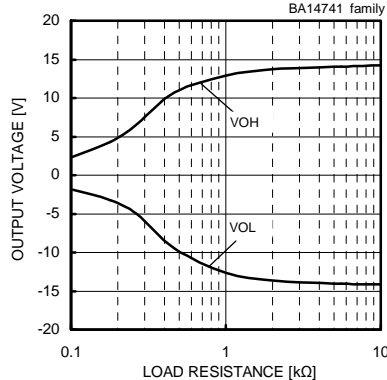

Fig. 225

Maximum Output Voltage - Load Resistance
(VCC/VEE=+15[V]/-15[V], Ta=25[°C])

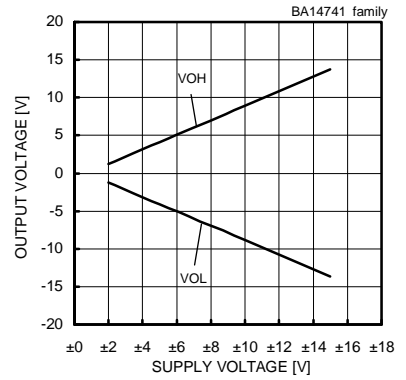

Fig. 226

Maximum Output Voltage - Supply Voltage
(RL=2[kΩ], Ta=25[°C])

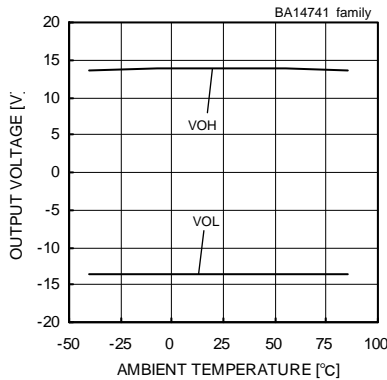

Fig. 227

Maximum Output Voltage - Ambient Temperature
(VCC/VEE=+15[V]/-15[V], RL=2[kΩ])

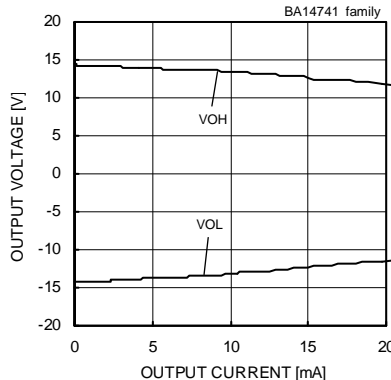

Fig. 228

Maximum Output Voltage - Output Current
(VCC/VEE=+15[V]/-15[V], Ta=25[°C])

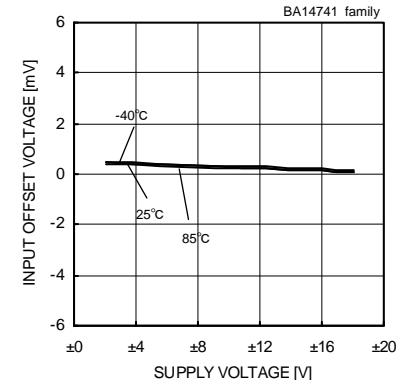

Fig. 229

Input Offset Voltage - Supply Voltage
(Vicm=0[V], Vout=0[V])

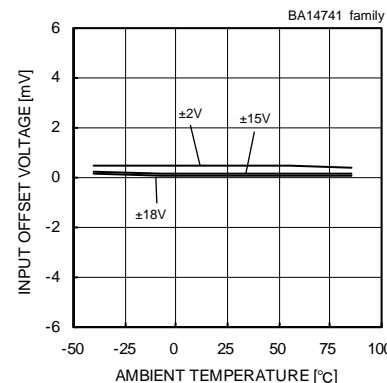

Fig. 230

Input Offset Voltage - Ambient Temperature
(Vicm=0[V], Vout=0[V])

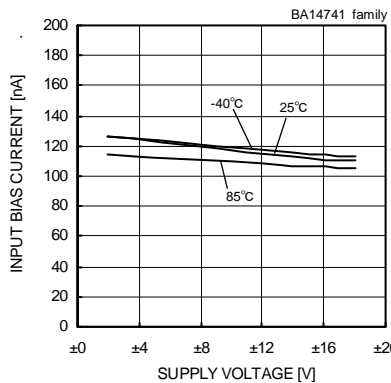

Fig. 231

Input Bias Current - Supply Voltage
(Vicm=0[V], Vout=0[V])

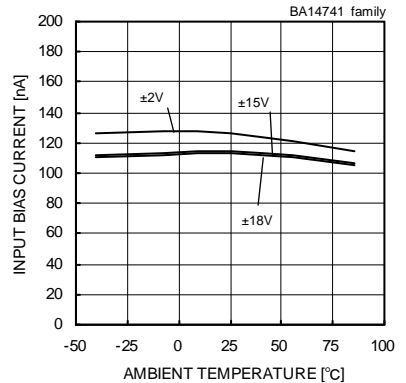

Fig. 232

Input Bias Current - Ambient Temperature
(Vicm=0[V], Vout=0[V])

(*)The above data is ability value of sample, it is not guaranteed.

●Reference Data BA14741 family

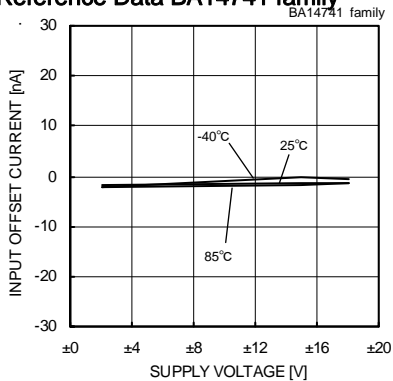

Fig. 233

Input Offset Current - Supply Voltage
($V_{icm}=0[V]$, $V_{out}=0[V]$)

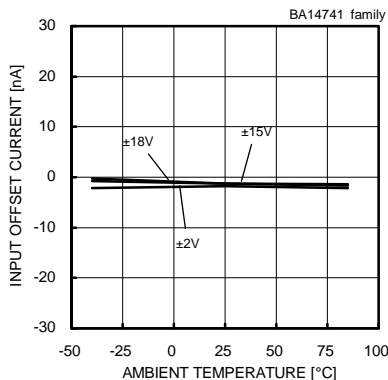

Fig. 234

Input Offset Current - Ambient Temperature
($V_{icm}=0[V]$, $V_{out}=0[V]$)

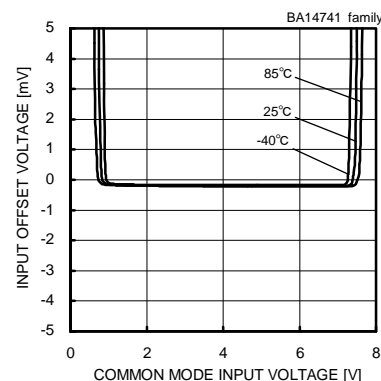

Fig. 235

Input Offset Voltage - Common Mode Input Voltage
($V_{CC}=8[V]$, $V_{out}=4[V]$)

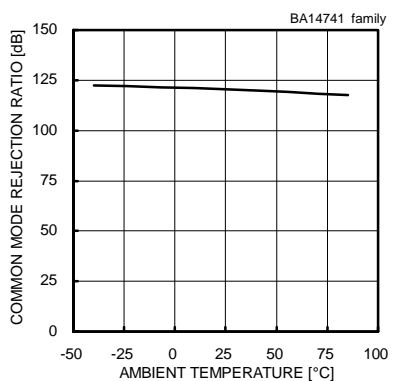

Fig. 236

Common Mode Rejection Ratio - Ambient Temperature
($V_{CC}/V_{EE}=+15[V]/-15[V]$, $V_{icm}=-12[V]$ to $+12[V]$)

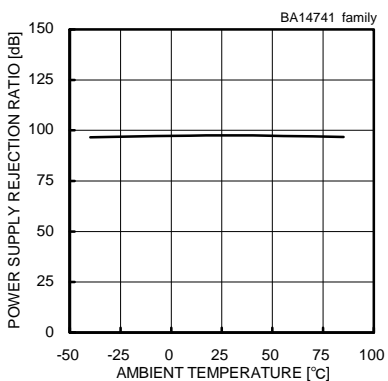

Fig. 237

Power Supply Rejection Ratio - Ambient Temperature
($V_{CC}/V_{EE}=+2[V]/-2[V]$ to $+15[V]/-15[V]$)

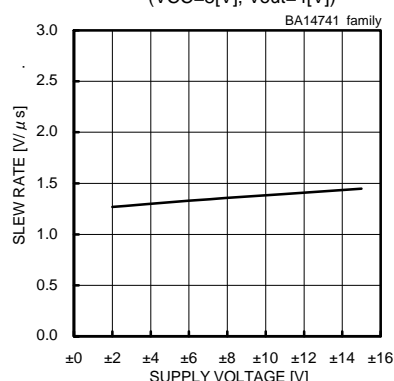

Fig. 238

Slew Rate - Supply Voltage
($C_L=100[pF]$, $R_L=2[kΩ]$, $T_a=25[°C]$)

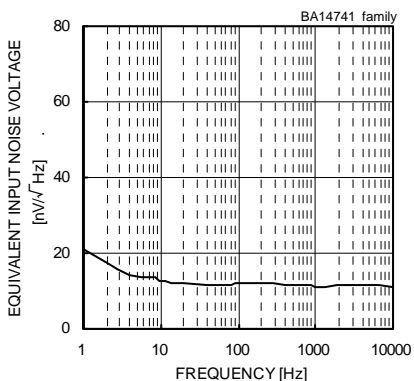

Fig. 239

Equivalent Input Noise Voltage - Frequency
($V_{CC}/V_{EE}=+15[V]/-15[V]$, $R_s=100[Ω]$, $T_a=25[°C]$)

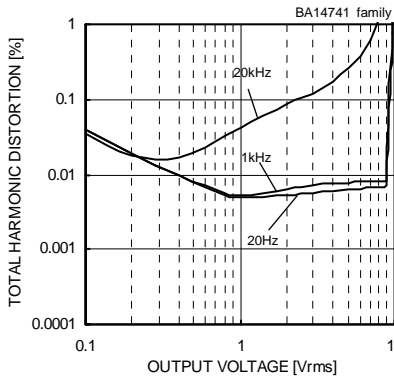

Fig. 240

Total Harmonic Distortion - Output Voltage
($V_{CC}/V_{EE}=+15[V]/-15[V]$, $A_v=20[dB]$, $R_L=2[kΩ]$, $80[kHz]$ -LPF, $T_a=25[°C]$)

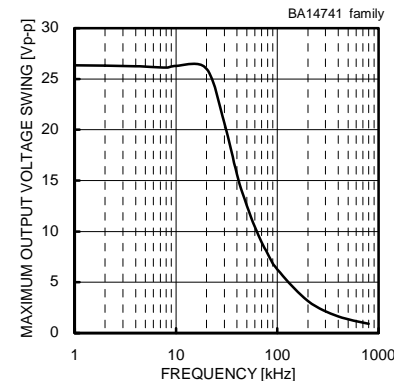

Fig. 241

Maximum Output Voltage Swing - Frequency
($V_{CC}/V_{EE}=+15[V]/-15[V]$, $R_L=2[kΩ]$, $T_a=25[°C]$)

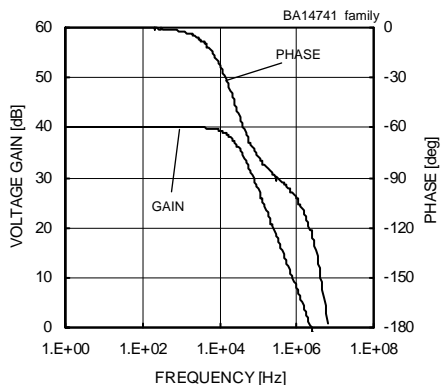

Fig. 242

Voltage Gain - Frequency
($V_{CC}/V_{EE}=+15[V]/-15[V]$, $A_v=40[dB]$, $R_L=2[kΩ]$, $T_a=25[°C]$)

(*)The above data is ability value of sample, it is not guaranteed.

●Reference Data BA15532 family

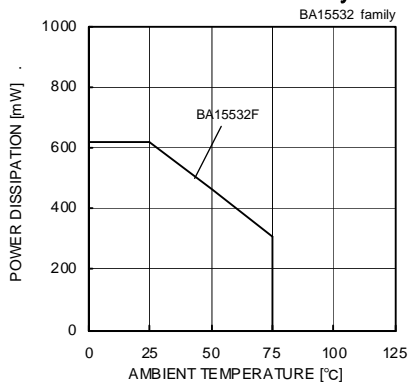

Fig. 243 Derating Curve

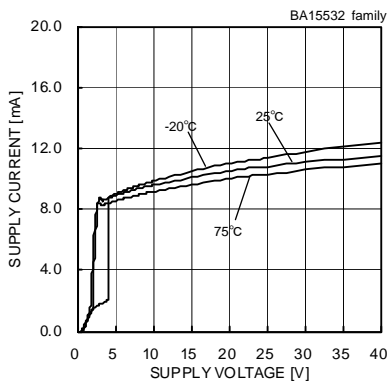

Fig. 244 Supply Current - Supply Voltage

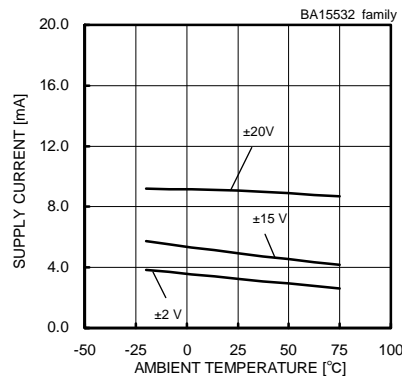

Fig. 245 Supply Current - Ambient Temperature

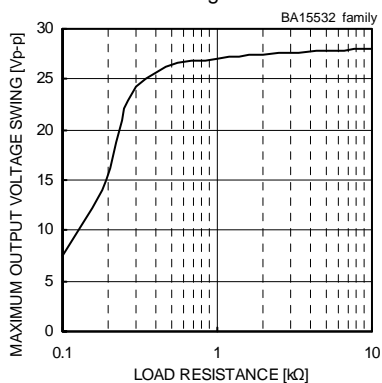

Fig. 246 Maximum Output Voltage Swing - Load Resistance
(VCC/VEE=+15[V]/-15[V], Ta=25[°C])

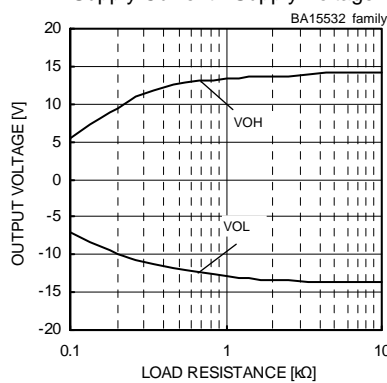

Fig. 247 Maximum Output Voltage - Load Resistance
(VCC/VEE=+15[V]/-15[V], Ta=25[°C])

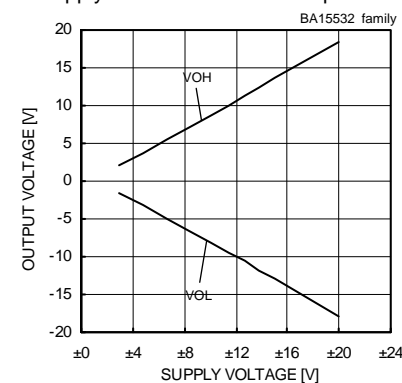

Fig. 248 Maximum Output Voltage - Supply Voltage
(RL=600[Ω], Ta=25[°C])

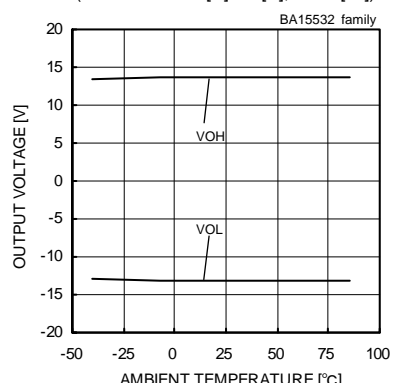

Fig. 249 Maximum Output Voltage - Ambient Temperature
(VCC/VEE=+15[V]/-15[V], RL=2[kΩ])

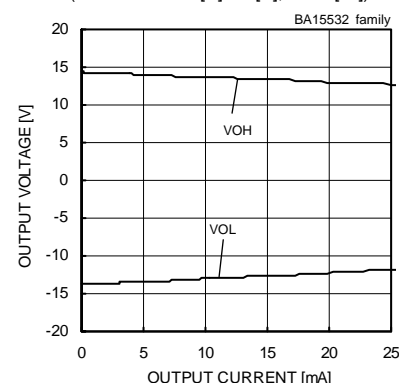

Fig. 250 Maximum Output Voltage - Output Current
(VCC/VEE=+15[V]/-15[V], Ta=25[°C])

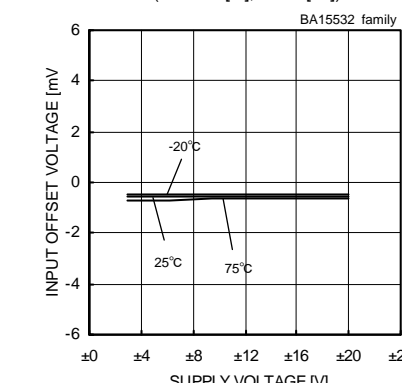

Fig. 251 Input Offset Voltage - Supply Voltage
(Vicm=0[V], Vout=0[V])

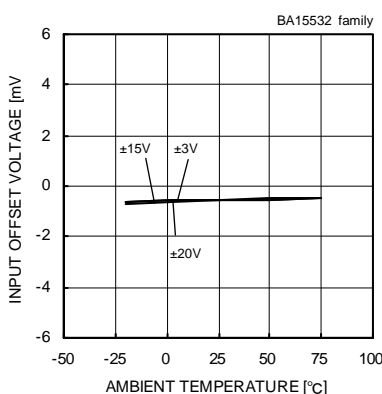

Fig. 252 Input Offset Voltage - Ambient Temperature
(Vicm=0[V], Vout=0[V])

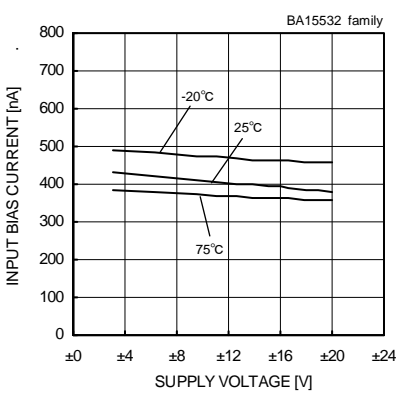

Fig. 253 Input Bias Current - Supply Voltage
(Vicm=0[V], Vout=0[V])

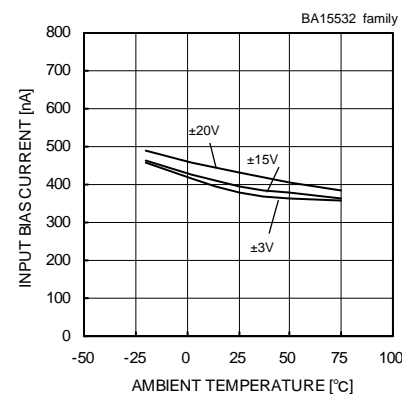

Fig. 254 Input Bias Current - Ambient Temperature
(Vicm=0[V], Vout=0[V])

ⒸThe above data is ability value of sample, it is not guaranteed.

●Reference Data BA15532 family

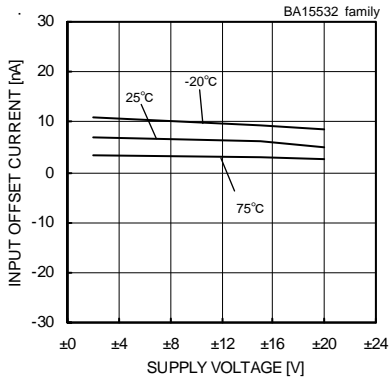

Fig. 255
Input Offset Current - Supply Voltage
($V_{icm}=0[V]$, $V_{out}=0[V]$)

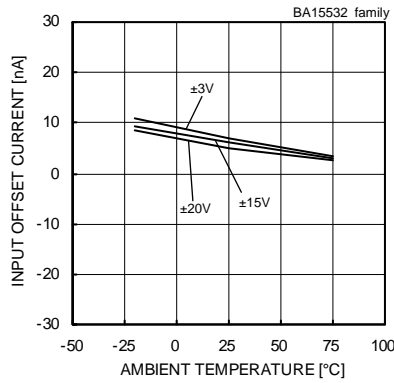

Fig. 256
Input Offset Current - Ambient Temperature
($V_{icm}=0[V]$, $V_{out}=0[V]$)

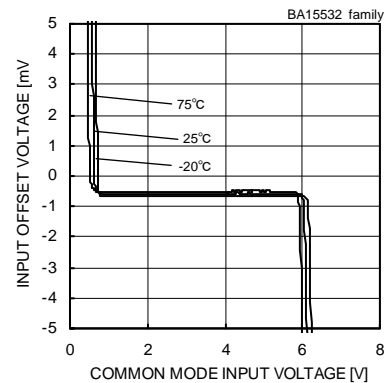

Fig. 257
Input Offset Voltage
- Common Mode Input Voltage
($V_{CC}=8[V]$, $V_{out}=4[V]$)

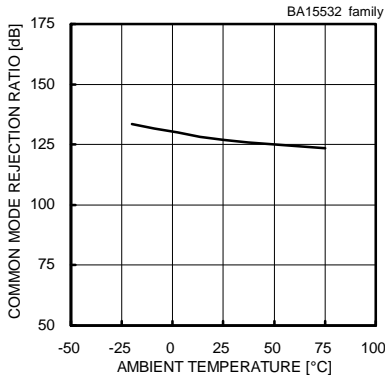

Fig. 258
Common Mode Rejection Ratio
- Ambient Temperature
($V_{CC}/V_{EE}=+15[V]/-15[V]$, $V_{icm}=-12[V]$ to $+12[V]$)

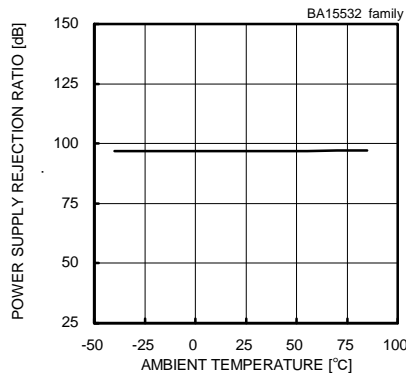

Fig. 259
Power Supply Rejection Ratio

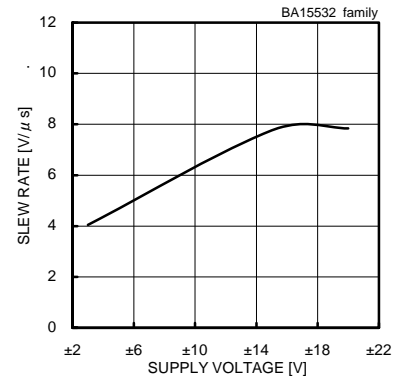

Fig. 260
Slew Rate - Supply Voltage
($C_L=100[pF]$, $R_L=2[k\Omega]$, $T_a=25[^\circ C]$)

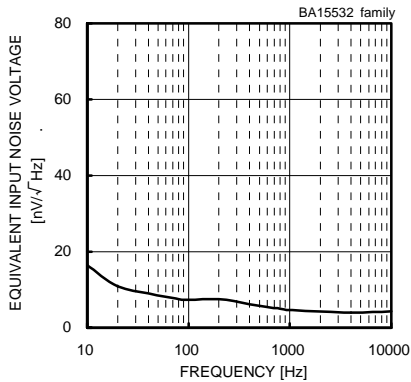

Fig. 261
Equivalent Input Noise Voltage - Frequency
($V_{CC}/V_{EE}=+15[V]/-15[V]$, $R_s=100[\Omega]$, $T_a=25[^\circ C]$)

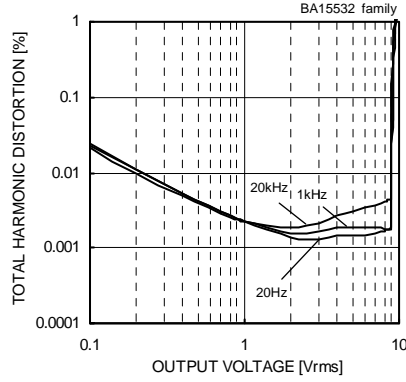

Fig. 262
Equivalent Input Noise Voltage - Frequency
($V_{CC}/V_{EE}=+15[V]/-15[V]$, $A_v=20[dB]$, $R_L=600[\Omega]$, $80[kHz]$ -LPF, $T_a=25[^\circ C]$)

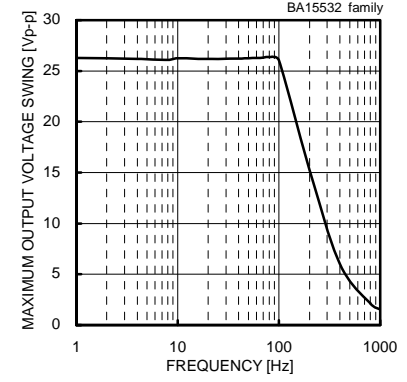

Fig. 263
Maximum Output Voltage Swing - Frequency
($V_{CC}/V_{EE}=+15[V]/-15[V]$, $R_L=600[\Omega]$, $T_a=25[^\circ C]$)

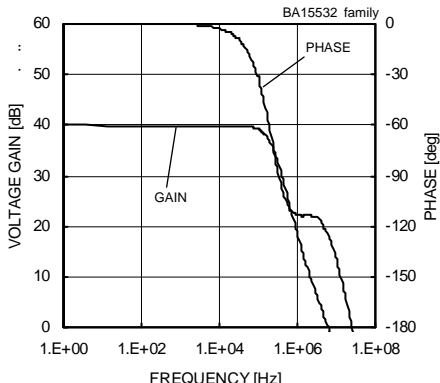

Fig. 264
Voltage Gain - Frequency
($V_{CC}/V_{EE}=+15[V]/-15[V]$, $A_v=40[dB]$, $R_L=2[k\Omega]$, $T_a=25[^\circ C]$)

(*)The above data is ability value of sample, it is not guaranteed

●Reference Data BA4510 family

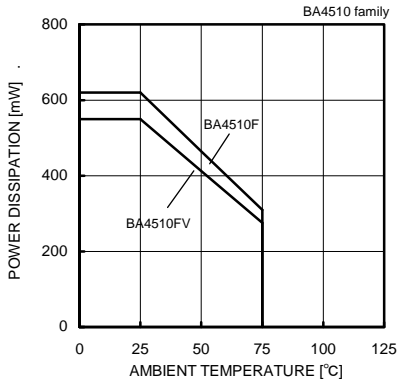

Fig. 265
Derating Curve

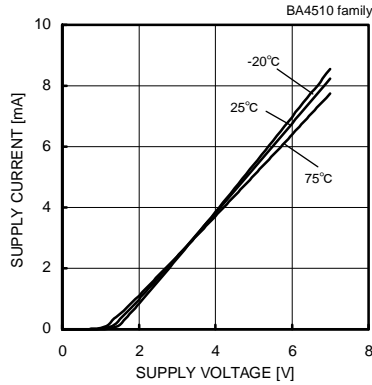

Fig. 266
Supply Current - Supply Voltage

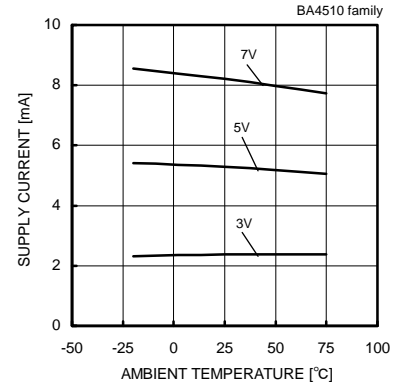

Fig. 267
Supply Current - Ambient Temperature

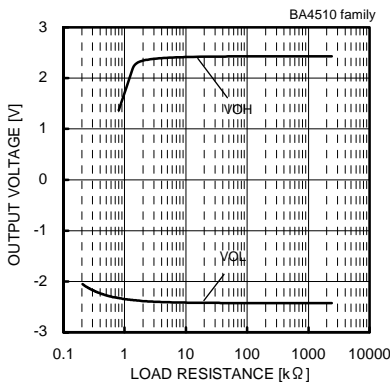

Fig. 268
Maximum Output Voltage Swing
- Load Resistance
(VCC/VEE=2.5[V]/-2.5[V], Ta=25[°C])

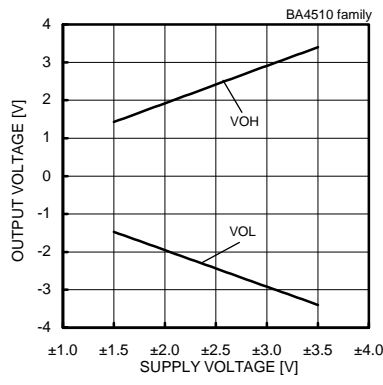

Fig. 269
Maximum Output Voltage
- Supply Voltage
(RL=10[kΩ], Ta=25[°C])

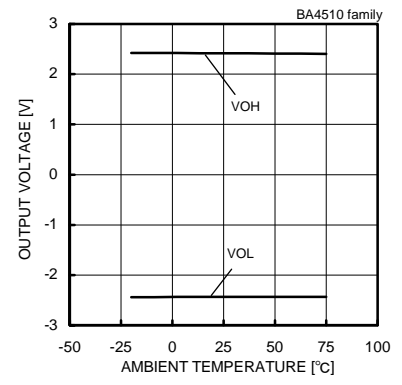

Fig. 270
Maximum Output Voltage
- Ambient Temperature
(VCC/VEE=2.5[V]/-2.5[V], RL=10[kΩ])

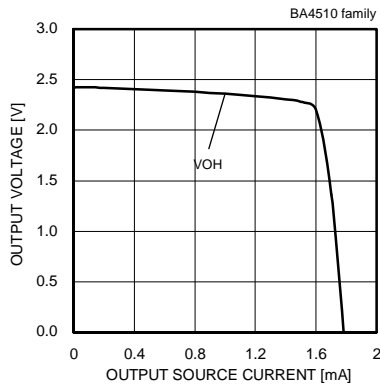

Fig. 271
Maximum Output Voltage
- Output Source Current
(VCC/VEE=2.5[V]/-2.5[V], Ta=25[°C])

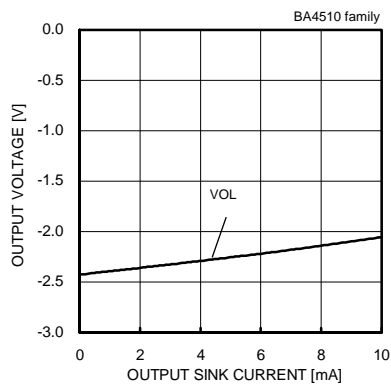

Fig. 272
Maximum Output Voltage
- Output Sink Current
(VCC/VEE=2.5[V]/-2.5[V], Ta=25[°C])

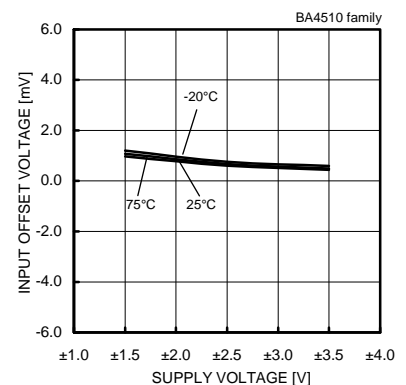

Fig. 273
Input Offset Voltage - Supply Voltage
(Vicm=0[V], Vout=0[V])

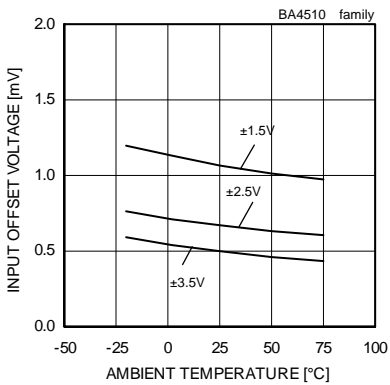

Fig. 274
Input Offset Voltage - Ambient Temperature
(Vicm=0[V], Vout=0[V])

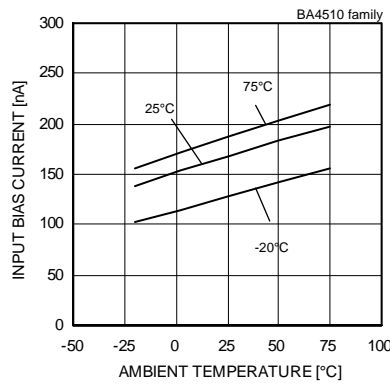

Fig. 275
Input Bias Current - Supply Voltage
(Vicm=0[V], Vout=0[V])

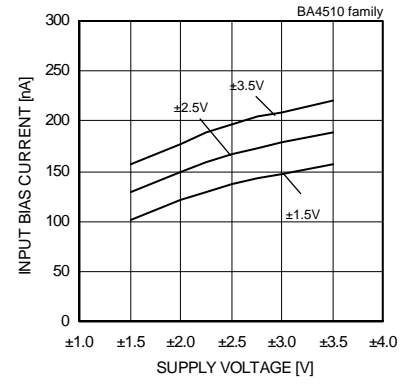

Fig. 276
Input Bias Current - Ambient Temperature
(Vicm=0[V], Vout=0[V])

(*)The above data is ability value of sample, it is not guaranteed.

●Reference Data BA4510 family

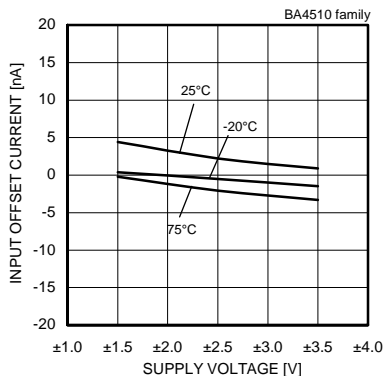

Fig. 277
Input Offset Current - Supply Voltage
($V_{icm}=0[V]$, $V_{out}=0[V]$)

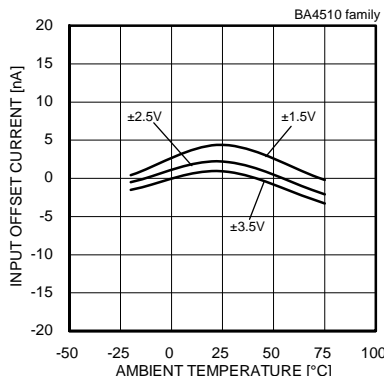

Fig. 278
Input Offset Current - Ambient Temperature
($V_{icm}=0[V]$, $V_{out}=0[V]$)

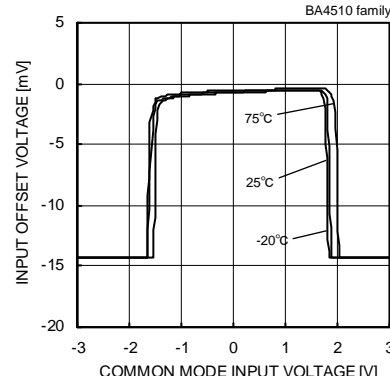

Fig. 279
Input Offset Voltage
- Common Mode Input Voltage
($V_{CC}/V_{EE}=2.5[V]/-2.5[V]$)

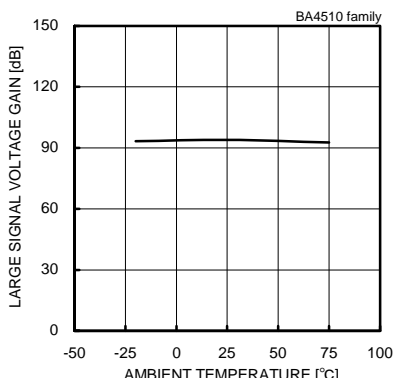

Fig. 280
Large Signal Voltage Gain
- Ambient Temperature

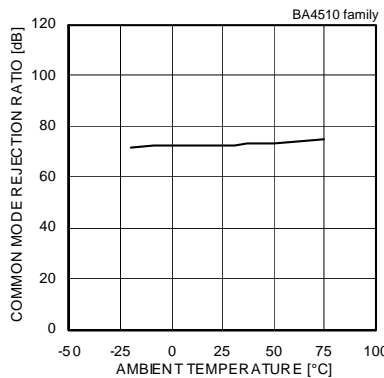

Fig. 281
Common Mode Rejection Ratio
- Ambient Temperature

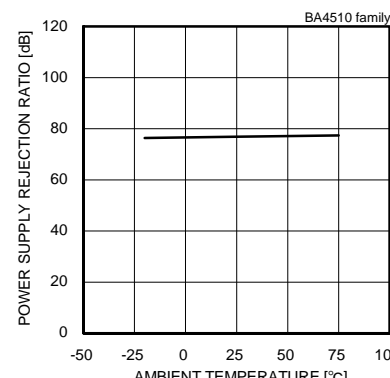

Fig. 282
Power Supply Rejection Ratio
- Ambient Temperature

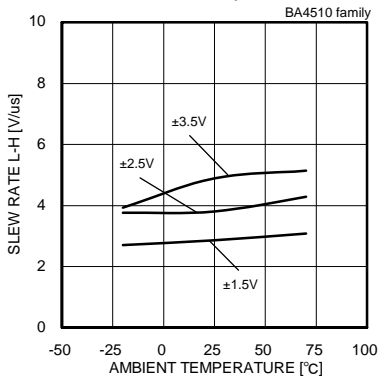

Fig. 283
Slew Rate L-H - Ambient Temperature

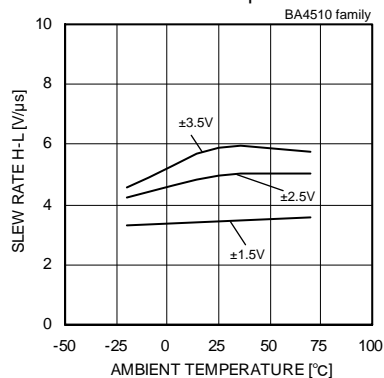

Fig. 284
Slew Rate H-L - Ambient Temperature

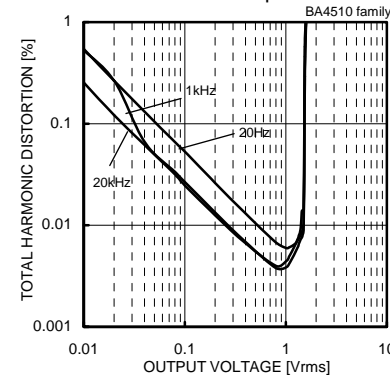

Fig. 285
Total Harmonic Distortion - Output Voltage
($V_{CC}/V_{EE}=2.5[V]/-2.5[V]$, $R_L=3[k\Omega]$ 80[kHz]-LPF, $T_a=25[^\circ C]$)

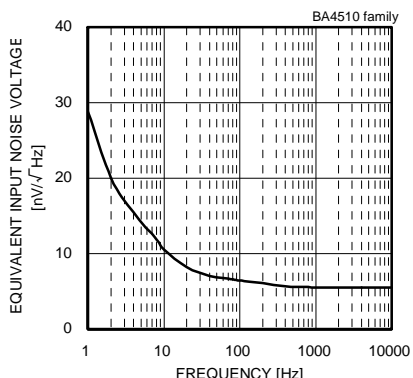

Fig. 286
Equivalent Input Noise Voltage - Frequency
($V_{CC}/V_{EE}=2.5[V]/-2.5[V]$)

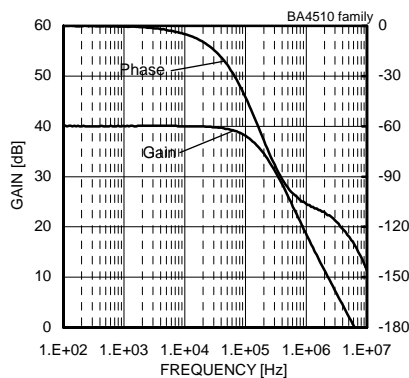

Fig. 287
Voltage Gain - Frequency
($V_{CC}/V_{EE}=2.5[V]/-2.5[V]$, $A_v=40[dB]$, $R_L=10[k\Omega]$)

(*)The above data is ability value of sample, it is not guaranteed.

●Reference Data BA2115 family

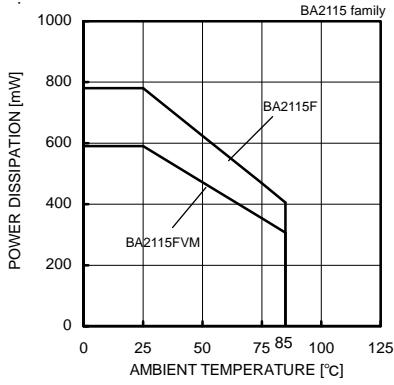

Fig. 288
Derating Curve

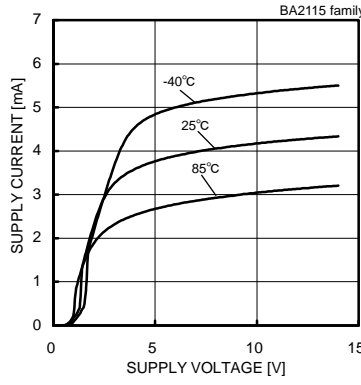

Fig. 289
Supply Current - Supply Voltage

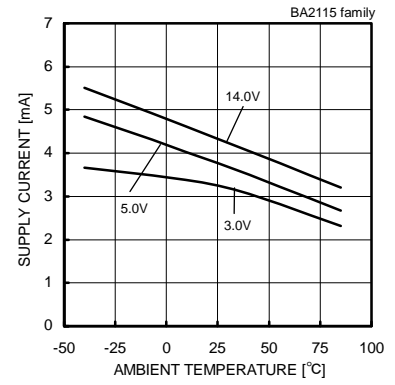

Fig. 290
Supply Current - Ambient Temperature

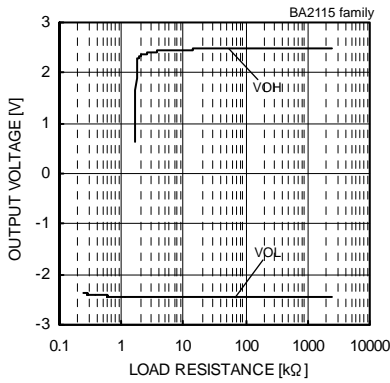

Fig. 291
Output Voltage - Load Resistance
(VCC/VEE=+2.5[V]/-2.5[V])

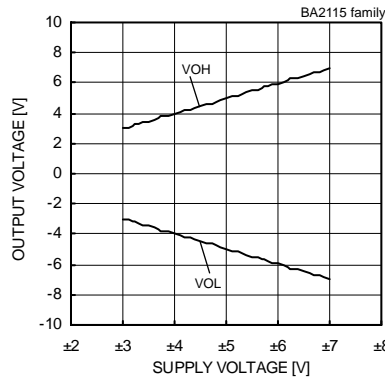

Fig. 292
Maximum Output Voltage
- Supply Voltage
(RL=10[kΩ])

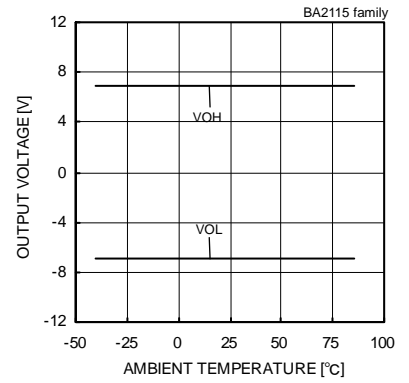

Fig. 293
Maximum Output Voltage
- Ambient Temperature
(VCC/VEE=+7.5[V]/-7.5[V], RL=10[kΩ])

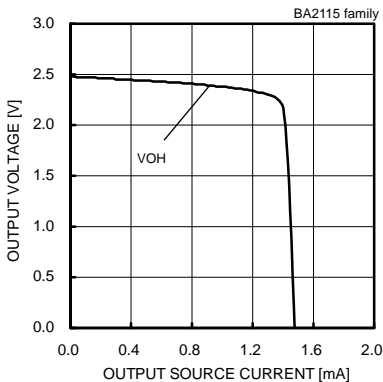

Fig. 294
Maximum Output Voltage
- Output Source Current
(VCC/VEE=+2.5[V]/-2.5[V])

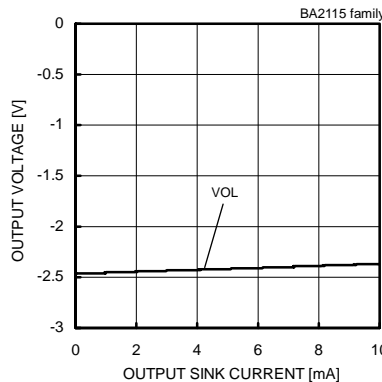

Fig. 295
Maximum Output Voltage
- Output Sink Current
(VCC/VEE=+2.5[V]/-2.5[V])

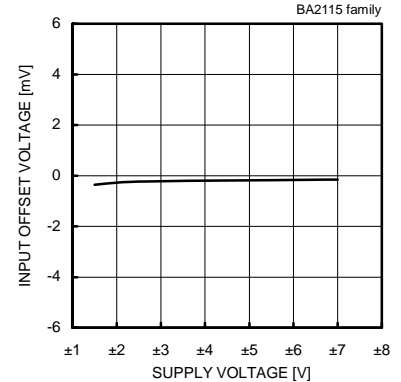

Fig. 296
Input Offset Voltage - Supply Voltage
(Vicm=0[V], Vout=0[V])

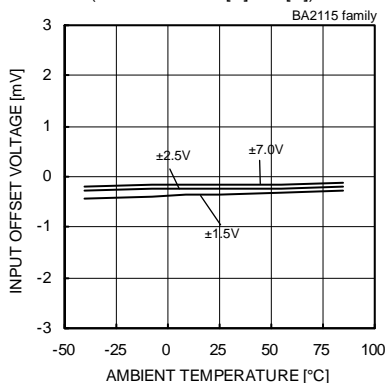

Fig. 297
Input Offset Voltage - Ambient Temperature
(Vicm=0[V], Vout=0[V])

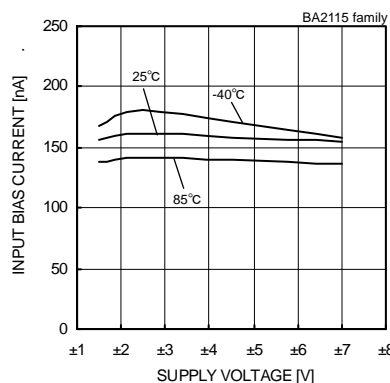

Fig. 298
Input Bias Current - Supply Voltage
(Vicm=0[V], Vout=0[V])

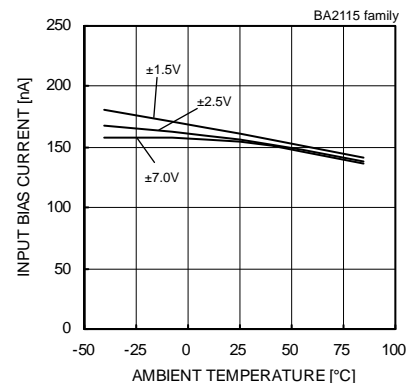

Fig. 299
Input Bias Current - Ambient Temperature
(Vicm=0[V], Vout=0[V])

(*The above data is ability value of sample, it is not guaranteed.

●Reference Data BA2115 family

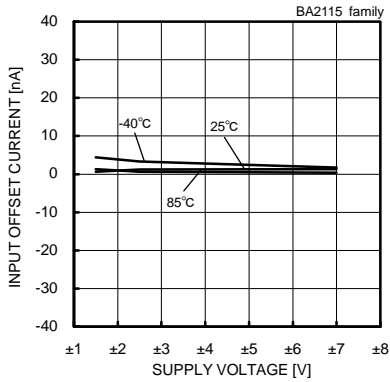

Fig. 300
Input Offset Current - Supply Voltage
($V_{icm}=0[V]$, $V_{out}=0[V]$)

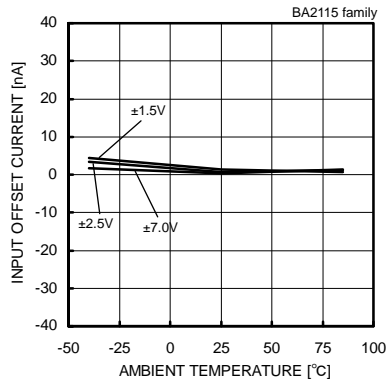

Fig. 301
Input Offset Current - Ambient Temperature
($V_{icm}=0[V]$, $V_{out}=0[V]$)

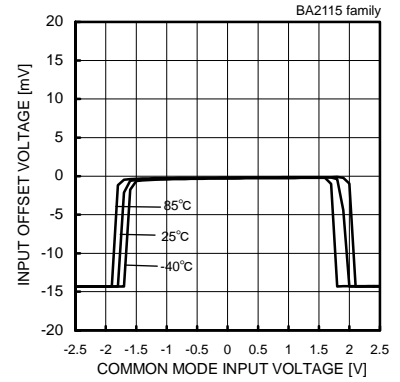

Fig. 302
Input Offset Voltage
- Common Mode Input Voltage
($V_{CC}/V_{EE}=+2.5[V]/-2.5[V]$, $V_{out}=0[V]$)

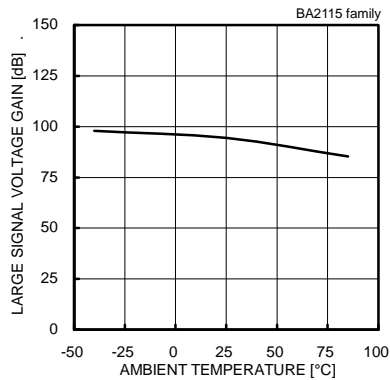

Fig. 303
Large Signal Voltage Gain
- Ambient Temperature
($V_{CC}/V_{EE}=+2.5[V]/-2.5[V]$)

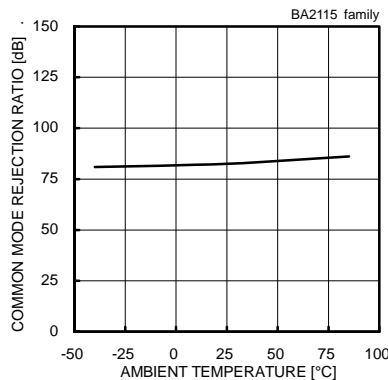

Fig. 304
Common Mode Rejection Ratio
- Ambient Temperature
($V_{CC}/V_{EE}=+2.5[V]/-2.5[V]$)

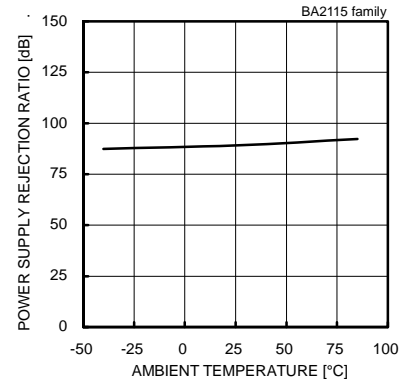

Fig. 305
Power Supply Rejection Ratio
- Ambient Temperature
($V_{CC}/V_{EE}=+2.5[V]/-2.5[V]$)

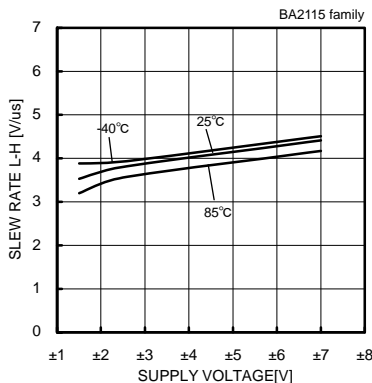

Fig. 306
Slew Rate L-H - Supply Voltage

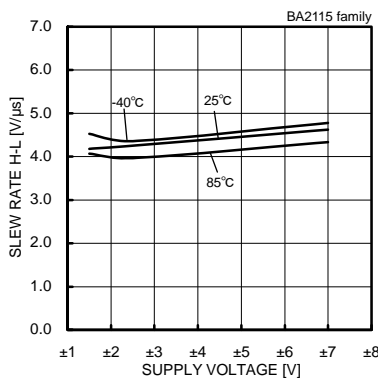

Fig. 307
Slew Rate H-L - Supply Voltage

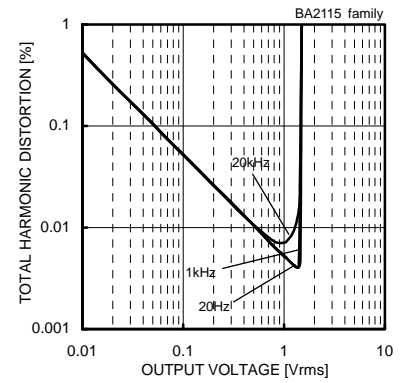

Fig. 308
Total Harmonic Distortion - Output Voltage
($V_{CC}/V_{EE}=2.5[V]/-2.5[V]$, $R_L=3[k\Omega]$,
80[kHz]-LPF, $T_a=25[^\circ C]$)

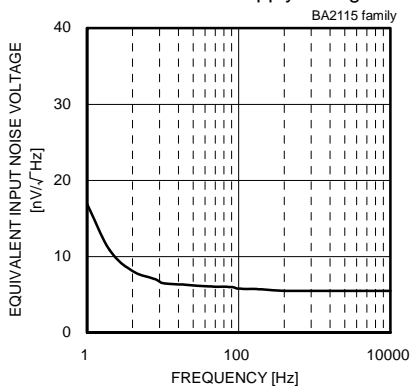

Fig. 309
Equivalent Input Noise Voltage - Frequency
($V_{CC}/V_{EE}=2.5[V]/-2.5[V]$)

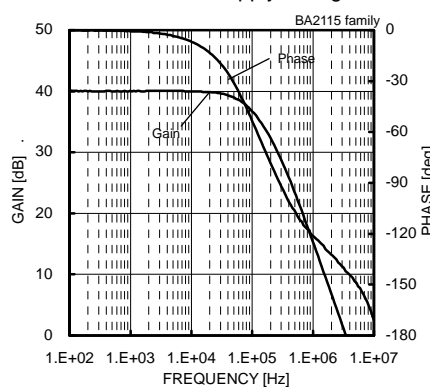

Fig. 310
Voltage Gain - Frequency
($V_{CC}/V_{EE}=2.5[V]/-2.5[V]$, $A_v=40[dB]$, $R_L=10[k\Omega]$)

(*)The above data is ability value of sample, it is not guaranteed.

● Schematic diagram

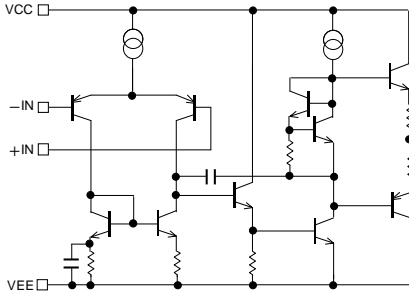

Fig. 311 Simplified schematic
(BA4558/BA4558R/BA15218/BA4560/BA4564R/
BA4560R/BA4580R/BA4584/BA4584R/BA8522R)

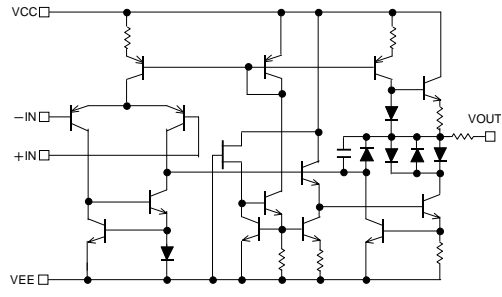

Fig. 312 Simplified schematic
(BA14741)

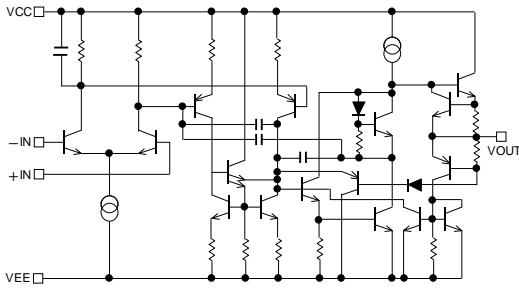

Fig. 313 Simplified schematic
(BA15532)

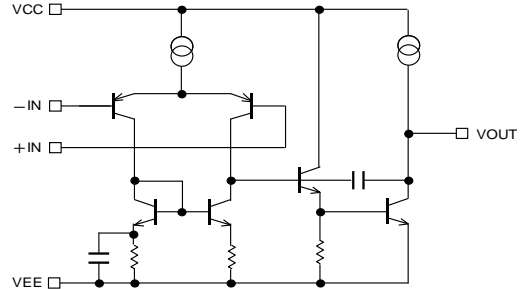

Fig. 314 Simplified schematic
(BA4510/BA2115)

● Test circuit 1 NULL method

VCC, VEE, EK, Vicm Unit: [V], Vicm=0[V] for all parameter

Parameter	VF	S1	S2	S3 (*35)	BA4558/BA4558R BA4560/BA4560R BA4564R			BA4580R/BA4584 BA4584R/BA8522R BA15218/BA14741			BA15532			BA4510			BA2115			Calculation
					Vcc	VEE	EK	Vcc	VEE	EK	Vcc	VEE	EK	Vcc	VEE	EK	Vcc	VEE	EK	
Input Offset Voltage	VF1	ON	ON	OFF	15	-15	0	15	-15	0	15	-15	0	2.5	-2.5	0	2.5	-2.5	0	1
Input Offset Current	VF2	OFF	OFF	OFF	15	-15	0	15	-15	0	15	-15	0	2.5	-2.5	0	2.5	-2.5	0	2
Input Bias Current	VF3	OFF	ON	OFF	15	-15	0	15	-15	0	15	-15	0	2.5	-2.5	0	2.5	-2.5	0	3
	VF4	ON	OFF		15	-15	0	15	-15	0	15	-15	0	2.5	-2.5	0	2.5	-2.5	0	
Large Signal Voltage Gain	VF5	ON	ON	ON	15	-15	-10	15	-15	-10	15	-15	-10	2.5	-2.5	-1.0	2.5	-2.5	-1.0	4
	VF6				15	-15	10	15	-15	10	15	-15	10	2.5	-2.5	1.0	2.5	-2.5	1.0	
Common-mode Rejection Ratio (Input Common-mode Voltage Range)	VF7	ON	ON	OFF	3	-27	12	3	-27	12	3	-27	12	1.5	-3.5	-1.0	1.5	-3.5	-1.0	5
	VF8				27	-3	-12	27	-3	-12	27	-3	-12	3.5	-1.5	1.0	3.5	-1.5	1.0	
Power Supply Rejection Ratio	VF9	ON	ON	OFF	4	-4	0	2	-2	0	3	-3	0	1.25	-1.25	0	0.75	-1.25	0	6
	VF10				15	-15	0	16	-16	0	20	-20	0	3.0	-3.0	0	7.0	-7.0	0	

(*35) S3 is always ON for BA15532.

-Calculation-

1. Input Offset Voltage (Vio)

$$V_{io} = \frac{|VF1|}{1 + R_f / R_s} \quad [V]$$

2. Input Offset Current (Iio)

$$I_{io} = \frac{|VF2 - VF1|}{R_i \times (1 + R_f / R_s)} \quad [A]$$

3. Input Bias Current (Ib)

$$I_b = \frac{|VF4 - VF3|}{2 \times R_{ix} (1 + R_f / R_s)} \quad [A]$$

4. Large Signal Voltage Gain (Av)

$$A_v = 20 \times \text{Log} \frac{\Delta E_k \times (1 + R_f / R_s)}{|VF5 - VF6|} \quad [dB]$$

5. Common-mode Rejection Ratio (CMRR)

$$CMRR = 20 \times \text{Log} \frac{\Delta V_{icm} \times (1 + R_f / R_s)}{|VF8 - VF7|} \quad [dB]$$

6. Power Supply Rejection Ratio (PSRR)

$$PSRR = 20 \times \text{Log} \frac{\Delta V_{cc} \times (1 + R_f / R_s)}{|VF10 - VF9|} \quad [dB]$$

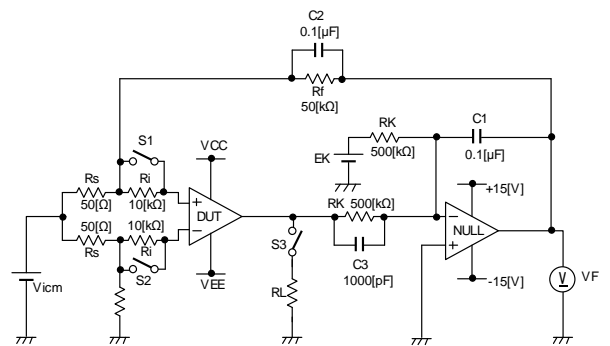

Fig. 315 Test circuit 1 (one channel only)

● Test circuit 2 switch condition

SW No.	SW 1	SW 2	SW 3	SW 4	SW 5	SW 6	SW 7	SW 8	SW 9	SW 10	SW 11	SW 12	SW 13	SW 14
Supply Current	OFF	OFF	OFF	ON	OFF	ON	OFF	OFF	OFF	OFF	OFF	OFF	OFF	OFF
Maximum Output Voltage	Load Resistance	OFF	OFF	ON	OFF	OFF	OFF	ON	OFF	ON	OFF	OFF	OFF	ON
	Output Current	OFF	OFF	ON	OFF	OFF	OFF	ON	OFF	OFF	OFF	OFF	ON	ON
Slew Rate	OFF	OFF	OFF	ON	OFF	OFF	OFF	ON	ON	ON	OFF	OFF	OFF	OFF
Gain Bandwidth Product	OFF	ON	OFF	OFF	ON	ON	OFF	OFF	ON	ON	ON	OFF	OFF	OFF
Total Harmonic Distortion	ON	OFF	OFF	OFF	ON	OFF	ON	OFF	ON	ON	ON	OFF	OFF	OFF
Input Noise Voltage (*36)	ON	OFF	OFF	OFF	ON	ON	OFF	OFF	OFF	OFF	ON	OFF	OFF	OFF

(*36) This condition refers only to BA4558R/BA4560R/BA4564R

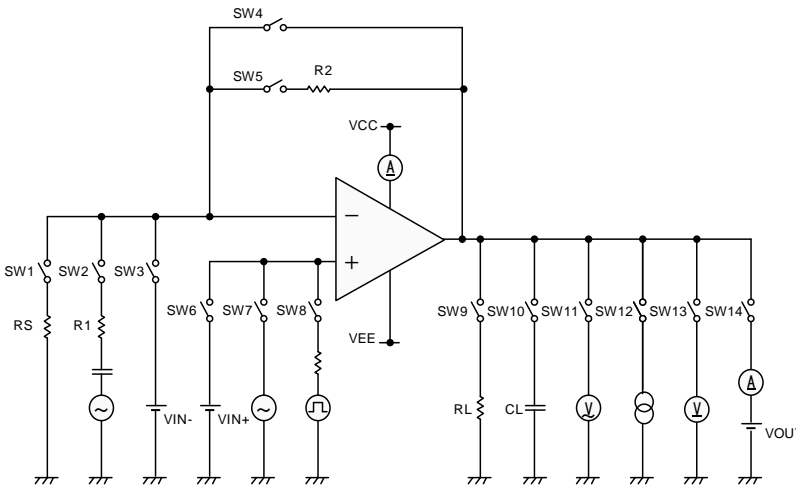

Fig. 316 Test circuit 2 (one channel only)

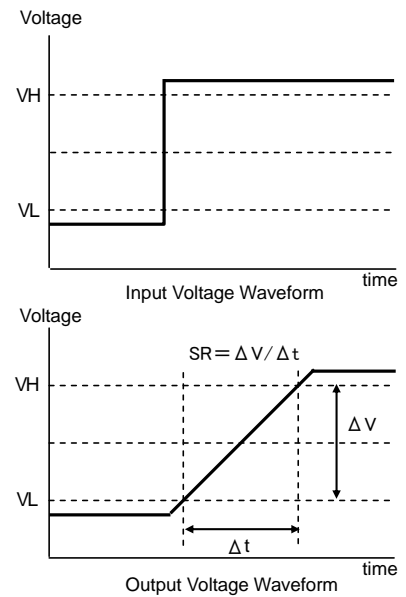

Fig. 317 Slew rate input output wave

● Test circuit 3 Channel separation

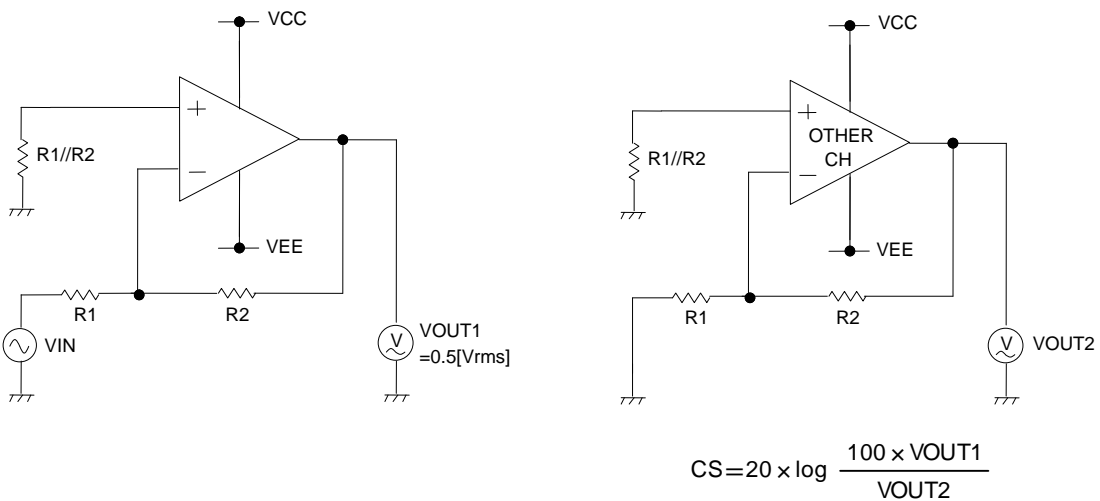

Fig. 318 Test circuit 3
(VCC=+15[V], VEE=-15[V], R1=1[kΩ], R2=100[kΩ])

●Derating curve

Power dissipation (total loss) indicates the power that can be consumed by IC at Ta=25°C(normal temperature).IC is heated when it consumed power, and the temperature of IC chip becomes higher than ambient temperature. The temperature that can be accepted by IC chip depends on circuit configuration, manufacturing process, and consumable power is limited. Power dissipation is determined by the temperature allowed in IC chip (maximum junction temperature) and thermal resistance of package (heat dissipation capability). The maximum junction temperature is typically equal to the maximum value in the storage temperature range. Heat generated by consumed power of IC radiates from the mold resin or lead frame of the package. The parameter which indicates this heat dissipation capability (hardness of heat release) is called thermal resistance, represented by the symbol θ_{j-a} [°C/W]. The temperature of IC inside the package can be estimated by this thermal resistance. Fig.319 (a) shows the model of thermal resistance of the package. Thermal resistance θ_{ja} , ambient temperature Ta, junction temperature Tj, and power dissipation Pd can be calculated by the equation below:

$$\theta_{ja} = (T_j - T_a) / P_d \quad [^{\circ}\text{C}/\text{W}] \quad \dots \dots \quad (I)$$

Derating curve in Fig.319 (b) indicates power that can be consumed by IC with reference to ambient temperature. Power that can be consumed by IC begins to attenuate at certain ambient temperature. This gradient is determined by thermal resistance θ_{ja} . Thermal resistance θ_{ja} depends on chip size, power consumption, package, ambient temperature, package condition, wind velocity, etc even when the same of package is used. Thermal reduction curve indicates a reference value measured at a specified condition. Fig.320(c), ~, (f) show a derating curve for an example of BA4558, BA4558R, BA4560, BA4560R, BA4564R, BA4580R, BA4584, BA4584R, BA8522R, BA15218, BA14741, BA15532, BA4510, BA2115.

Power dissipation of LSI [W]

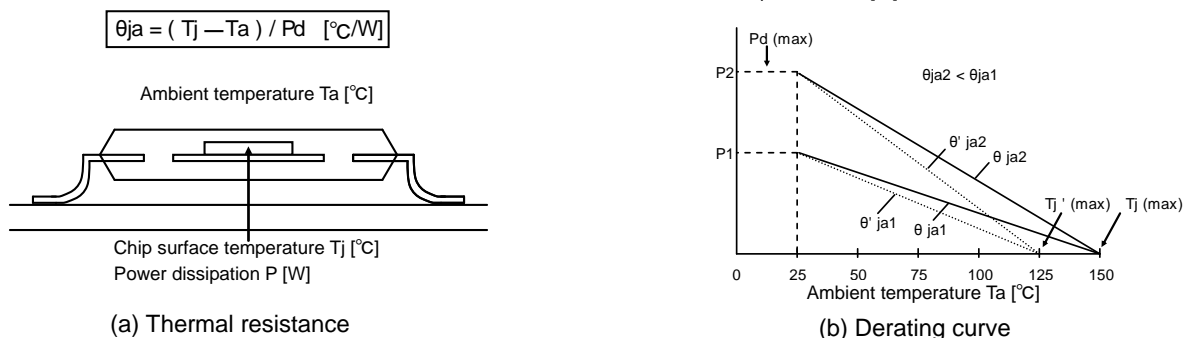
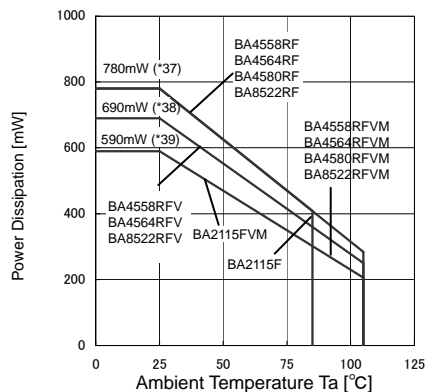
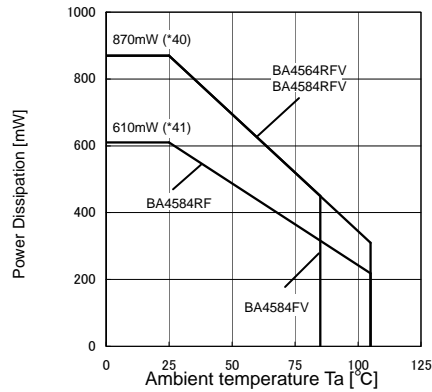

Fig. 319 Thermal resistance and derating curve



(c)BA4558R/BA4560R/BA4580R/BA8522R/BA2115 family



(d)BA4564R/BA4584/BA4584R family

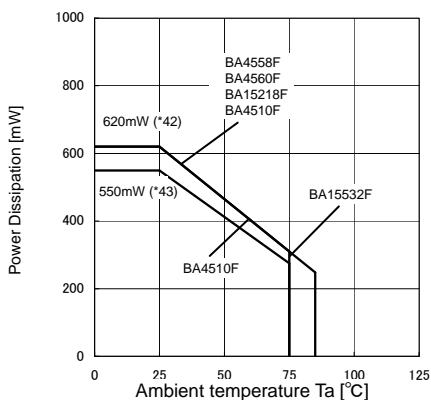

(e)BA4558/BA4560/BA15218/BA15532/BA4510 family

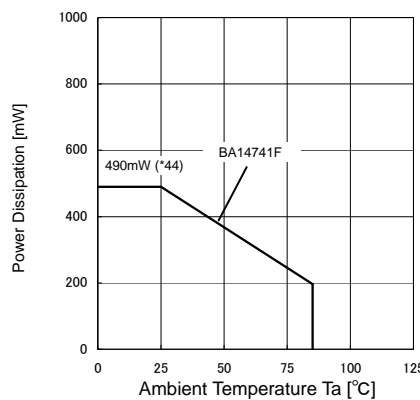

(f)BA14741F

(*37)	(*38)	(*39)	(*40)	(*41)	(*42)	(*43)	(*44)	Unit
6.2	5.5	4.7	7.0	5.3	6.2	5.5	4.9	[mW/°C]

When using the unit above Ta=25[°C], subtract the value above per degree[°C]. Permissible dissipation is the value.
When FR4 glass epoxy board 70[mm]x70[mm]x1.6[mm] (cooper foil area below 3[%]) is mounted.

Fig. 320 Derating curve

●Notes for use

- 1) Processing of unused circuit
It is recommended to apply connection (see the Fig.321) and set the non inverting input terminal at the potential within input common-mode voltage range (Vicm), for any unused circuit.
- 2) Input voltage
Applying VEE~VEE+36[V] (BA4580R, BA4584, BA4584R family), VEE+14[V] (BA2115 family) (VEE - 0.3) ~ (VEE + 36)[V] (BA4558R, BA4560R, 4564R, BA8522R)to the input terminal is possible without causing deterioration of the electrical characteristics or destruction, irrespective of the supply voltage. However, this does not ensure normal circuit operation. Please note that the circuit operates normally only when the input voltage is within the common mode input voltage range of the electric characteristics.
- 3) Maximum output voltage
Because the output voltage range becomes narrow as the output current increases, design the application with margin by considering changes in electrical characteristics and temperature characteristics.
- 4) Short-circuit of output terminal
When output terminal and VCC or VEE terminal are shorted, excessive Output current may flow under some conditions, and heating may destroy IC. It is necessary to connect a resistor as shown in Fig.322, thereby protecting against load shorting.
- 5) Power supply (split supply / single supply) in used
Op-amp operates when specified voltage is applied between VCC and VEE. Therefore, the single supply Op-Amp can be used for double supply Op-Amp as well.
- 6) Power dissipation (Pd)
Use a thermal design that allows for a sufficient margin in light of the power dissipation (Pd) in actual operating conditions.
- 7) Short-circuit between pins and wrong mounting
Pay attention to the assembly direction of the ICs. Wrong mounting direction or shorts between terminals, GND, or other components on the circuits, can damage the IC.
- 8) Use in strong electromagnetic field
Using the ICs in strong electromagnetic field can cause operation malfunction.
- 9) Radiation
This IC is not designed to be radiation-resistant.
- 10) Handling of IC
When stress is applied to IC because of deflection or bend of board, the characteristics may fluctuate due to piezoelectric (piezo) effect.
- 11) Inspection on set board
During testing, turn on or off the power before mounting or dismounting the board from the test Jig. Do not power up the board without waiting for the output capacitors to discharge. The capacitors in the low output impedance terminal can stress the device. Pay attention to the electro static voltages during IC handling, transportation, and storage.
- 12) Output capacitor
When VCC terminal is shorted to VEE (GND) potential and an electric charge has accumulated on the external capacitor, connected to output terminal, accumulated charge may be discharged VCC terminal via the parasitic element within the circuit or terminal protection element. The element in the circuit may be damaged (thermal destruction). When using this IC for an application circuit where there is oscillation, output capacitor load does not occur, as when using this IC as a voltage comparator. Set the capacitor connected to output terminal below 0.1[μF] in order to prevent damage to IC.

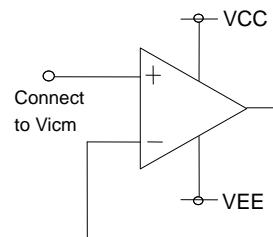

Fig. 321 The example of application circuit for unused op-amp

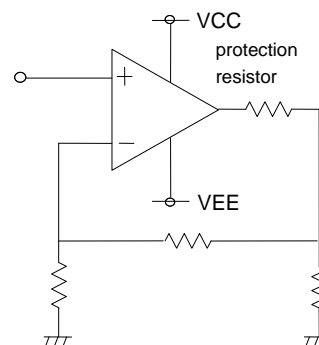

Fig. 322 The example of output short protection

●Description of electrical characteristics

Described here are the terms of electric characteristics used in this technical note. Items and symbols used are also shown. Note that item name and symbol and their meaning may differ from those on another manufacture's document or general document.

1. Absolute maximum ratings

Absolute maximum rating item indicates the condition which must not be exceeded. Application of voltage in excess of absolute maximum rating or use out of absolute maximum rated temperature environment may cause deterioration of characteristics.

1.1 Power supply voltage (VCC-VEE)

Indicates the maximum voltage that can be applied between the positive power supply terminal and negative power supply terminal without deterioration or destruction of characteristics of internal circuit.

1.2 Differential input voltage (V_{id})

Indicates the maximum voltage that can be applied between non-inverting terminal and inverting terminal without deterioration and destruction of characteristics of IC.

1.3 Input common-mode voltage range (V_{icm})

Indicates the maximum voltage that can be applied to non-inverting terminal and inverting terminal without deterioration or destruction of characteristics. Input common-mode voltage range of the maximum ratings not assure normal operation of IC. When normal operation of IC is desired, the input common-mode voltage of characteristics item must be followed.

1.4 Power dissipation (P_d)

Indicates the power that can be consumed by specified mounted board at the ambient temperature 25°C(normal temperature). As for package product, P_d is determined by the temperature that can be permitted by IC chip in the package (maximum junction temperature)and thermal resistance of the package.

2. Electrical characteristics item

2.1 Input offset voltage (V_{io})

Indicates the voltage difference between non-inverting terminal and inverting terminal. It can be translated into the input voltage difference required for setting the output voltage at 0 [V] .

2.2 Input offset current (I_{io})

Indicates the difference of input bias current between non-inverting terminal and inverting terminal.

2.3 Input bias current (I_b)

Indicates the current that flows into or out of the input terminal. It is defined by the average of input bias current at non-inverting terminal and input bias current at inverting terminal.

2.4 Input common-mode voltage range(V_{icm})

Indicates the input voltage range where IC operates normally.

2.5 Large signal voltage gain (A_V)

Indicates the amplifying rate (gain) of output voltage against the voltage difference between non-inverting terminal and Inverting terminal. It is normally the amplifying rate (gain) with reference to DC voltage.
 $A_v = (\text{Output voltage fluctuation}) / (\text{Input offset fluctuation})$

2.6 Circuit current (I_{CC})

Indicates the IC current that flows under specified conditions and no-load steady status.

2.7 Output sink current (I_{OL})

Denotes the maximum current that can be output under specific output conditions.

2.8 Output saturation voltage low level output voltage (V_{OL})

Signifies the voltage range that can be output under specific output conditions.

2.9 Output leakage current, High level output current (I_{leak})

Indicates the current that flows into IC under specified input and output conditions.

2.10 Common-mode rejection ratio (CMRR)

Indicates the ratio of fluctuation of input offset voltage when in-phase input voltage is changed. It is normally the fluctuation of DC.

$$\text{CMRR} = (\text{Change of Input common-mode voltage}) / (\text{Input offset fluctuation})$$

2.11 Power supply rejection ratio (PSRR)

Indicates the ratio of fluctuation of input offset voltage when supply voltage is changed. It is normally the fluctuation of DC.

$$\text{PSRR} = (\text{Change of power supply voltage}) / (\text{Input offset fluctuation})$$

○Voltage follower

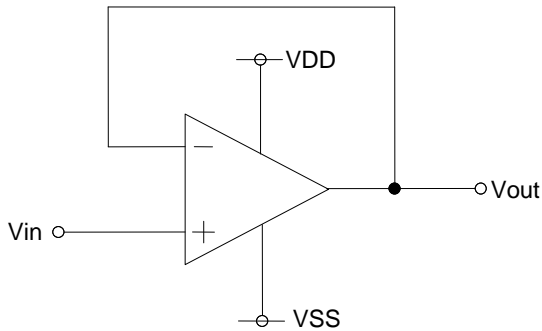

Fig. 323 Voltage follower circuit

Voltage gain is 0 [dB].

This circuit controls output voltage (Vout) equal input voltage (Vin), and keeps Vout with stable because of high input impedance and low output impedance.

Vout is shown next formula.

$$V_{out} = V_{in}$$

○Inverting amplifier

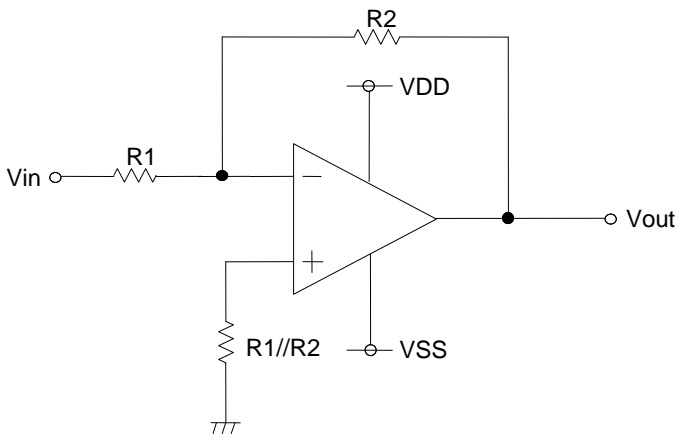

Fig. 324 Inverting amplifier circuit

For inverting amplifier, $V_i(b)$ Derating curve voltage gain decided R1 and R2, and phase reversed voltage is outputted.

Vout is shown next formula.

$$V_{out} = -(R_2/R_1) \cdot V_{in}$$

Input impedance is R1.

○Non-inverting amplifier

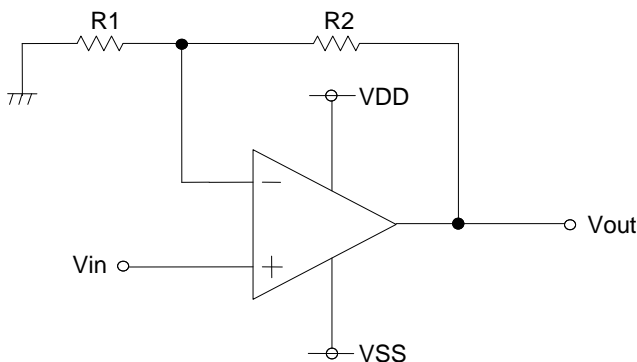

Fig. 325 Non-inverting amplifier circuit

For non-inverting amplifier, V_{in} is amplified by voltage gain decided R1 and R2, and phase is same with V_{in} .

Vout is shown next formula.

$$V_{out} = (1 + R_2/R_1) \cdot V_{in}$$

This circuit realizes high input impedance because Input impedance is operational amplifier's input Impedance.

●Ordering part number

B	A
---	---

Part No.

4	5	5	8
---	---	---	---

Part No.
4558, 4558R, 4560,
4560R, 4564R, 4580R,
4584, 4584R, 8522R
15218, 14741, 15532
4510, 2115

F	V
---	---

Package
F: SOP8
SOP14
FV: SSOP-B8
SSOP-B14
FVM: MSOP8

E	2
---	---

Packaging and forming specification
E2: Embossed tape and reel
(SOP8/SOP14/SSOP-B8/SSOP-B14)
TR: Embossed tape and reel
(MSOP8)

SOP8

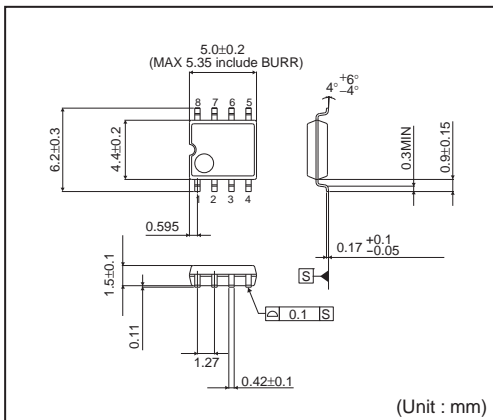

<Tape and Reel information>

Tape	Embossed carrier tape
Quantity	2500pcs
Direction of feed	E2 (The direction is the 1pin of product is at the upper left when you hold reel on the left hand and you pull out the tape on the right hand)

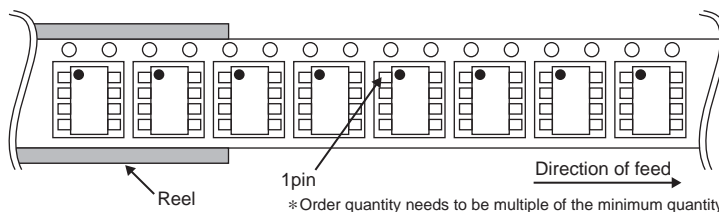

SOP14

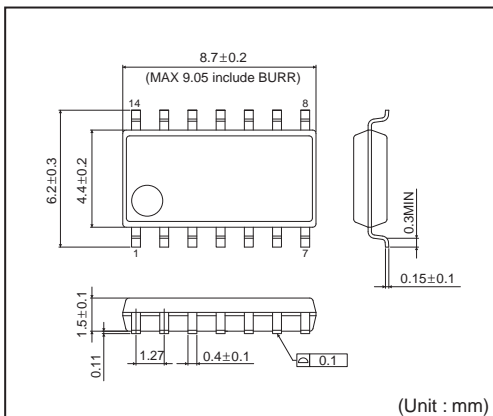

<Tape and Reel information>

Tape	Embossed carrier tape
Quantity	2500pcs
Direction of feed	E2 (The direction is the 1pin of product is at the upper left when you hold reel on the left hand and you pull out the tape on the right hand)

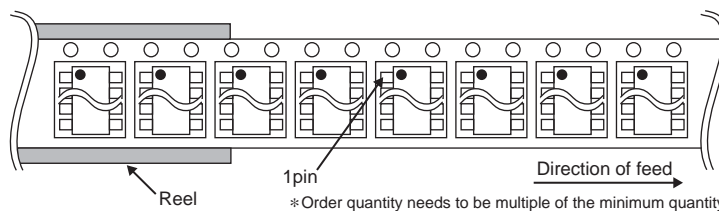

SSOP-B8

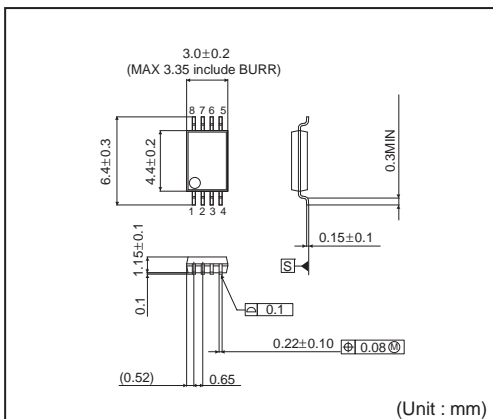

<Tape and Reel information>

Tape	Embossed carrier tape
Quantity	2500pcs
Direction of feed	E2 (The direction is the 1pin of product is at the upper left when you hold reel on the left hand and you pull out the tape on the right hand)

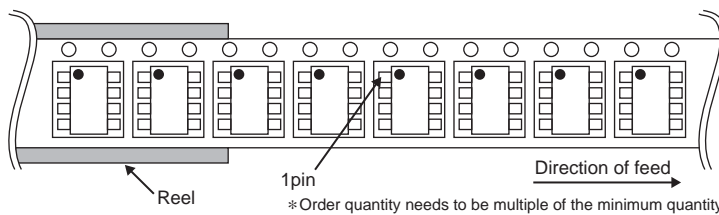

SSOP-B14

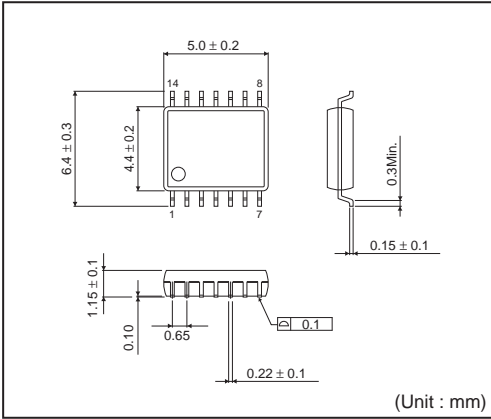

<Tape and Reel information>

Tape	Embossed carrier tape
Quantity	2500pcs
Direction of feed	E2 (The direction is the 1pin of product is at the upper left when you hold reel on the left hand and you pull out the tape on the right hand)

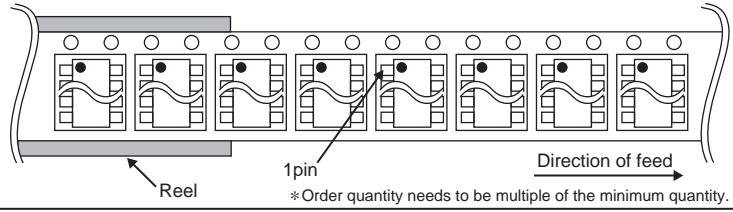

MSOP8

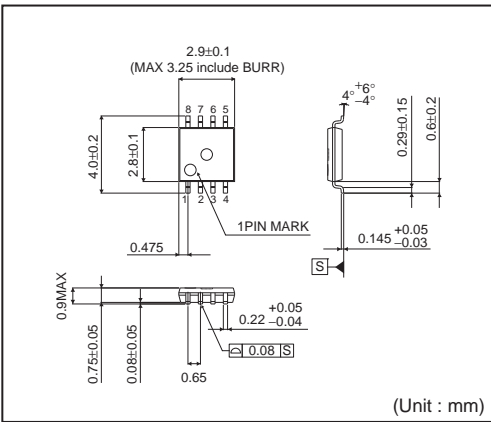

<Tape and Reel information>

Tape	Embossed carrier tape
Quantity	3000pcs
Direction of feed	TR (The direction is the 1pin of product is at the upper right when you hold reel on the left hand and you pull out the tape on the right hand)

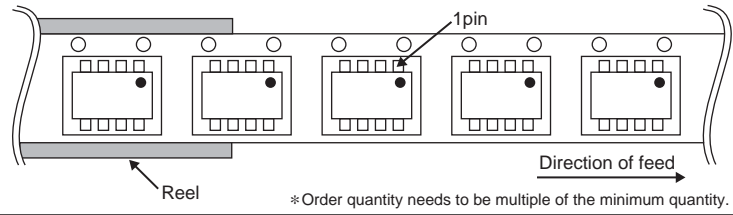

Notes

No copying or reproduction of this document, in part or in whole, is permitted without the consent of ROHM Co.,Ltd.

The content specified herein is subject to change for improvement without notice.

The content specified herein is for the purpose of introducing ROHM's products (hereinafter "Products"). If you wish to use any such Product, please be sure to refer to the specifications, which can be obtained from ROHM upon request.

Examples of application circuits, circuit constants and any other information contained herein illustrate the standard usage and operations of the Products. The peripheral conditions must be taken into account when designing circuits for mass production.

Great care was taken in ensuring the accuracy of the information specified in this document. However, should you incur any damage arising from any inaccuracy or misprint of such information, ROHM shall bear no responsibility for such damage.

The technical information specified herein is intended only to show the typical functions of and examples of application circuits for the Products. ROHM does not grant you, explicitly or implicitly, any license to use or exercise intellectual property or other rights held by ROHM and other parties. ROHM shall bear no responsibility whatsoever for any dispute arising from the use of such technical information.

The Products specified in this document are intended to be used with general-use electronic equipment or devices (such as audio visual equipment, office-automation equipment, communication devices, electronic appliances and amusement devices).

The Products specified in this document are not designed to be radiation tolerant.

While ROHM always makes efforts to enhance the quality and reliability of its Products, a Product may fail or malfunction for a variety of reasons.

Please be sure to implement in your equipment using the Products safety measures to guard against the possibility of physical injury, fire or any other damage caused in the event of the failure of any Product, such as derating, redundancy, fire control and fail-safe designs. ROHM shall bear no responsibility whatsoever for your use of any Product outside of the prescribed scope or not in accordance with the instruction manual.

The Products are not designed or manufactured to be used with any equipment, device or system which requires an extremely high level of reliability the failure or malfunction of which may result in a direct threat to human life or create a risk of human injury (such as a medical instrument, transportation equipment, aerospace machinery, nuclear-reactor controller, fuel-controller or other safety device). ROHM shall bear no responsibility in any way for use of any of the Products for the above special purposes. If a Product is intended to be used for any such special purpose, please contact a ROHM sales representative before purchasing.

If you intend to export or ship overseas any Product or technology specified herein that may be controlled under the Foreign Exchange and the Foreign Trade Law, you will be required to obtain a license or permit under the Law.



Thank you for your accessing to ROHM product informations.
More detail product informations and catalogs are available, please contact us.

ROHM Customer Support System

<http://www.rohm.com/contact/>