



Surge arresters

2-electrode arresters

Series/Type: EHV6* series
Ordering code:
Version/Date: Issue 10 / 2014-01-30

© EPCOS AG 2015. Reproduction, publication and dissemination of this publication, enclosures hereto and the information contained therein without EPCOS' prior express consent is prohibited.

EPCOS AG is a TDK Group Company.

Product description

The EHV6* series was specially designed to meet the strictest protection requirements. An optimized design features a high level of protection against fast rising transients usually caused by lightning disturbance. For use in high-frequency applications the series offers ultra-low capacitance and shows only marginal signal losses up to high frequencies. The devices are extremely reliable and are able to withstand high surge currents without destruction.

All tubes are produced to ISO TS 16949 standard together with products that have been in use in automotive applications for almost 20 years. The arresters are tested by automotive standards like IEC 60068 and can sustain high humidity environments and heavy vibration while maintaining full operability at all times. They can withstand high AC voltages without ignition. The EPCOS EHV series is fully UL graded and can be delivered for many different voltage levels as well as in different wire configurations.

Features

- Built to automotive standard (ISO TS 16949)
- Small sizes
- Fast response time
- High current handling capability
- Stable performance over service life
- Low capacitance and insertion loss
- High insulation resistance
- RoHS-compatible

Applications

Automotive:

- On-board battery chargers
- Vehicle charging stations

Others:

- LED lighting
- Power supplies
- Photovoltaic
- Antenna protection
- Air-conditioning

Product characteristics

Physical dimensions without lead wires (diameter x length)	Ø 0.24 x 0.28	in
	Ø 6.0 x 7.0	mm
Weight	~ 0.8	g
Operating temperature	-40 ... +125	°C
Recommended storage ¹⁾		
- temperature	+5 ... +35	°C
- humidity	45 ... 80	%
- period	≤ 2	years
Climatic category (IEC 60068-1)	40/ 125/ 21	
Moisture sensitivity level ²⁾	1	
Marking, blue positive	EPCOS XXXX YY XXXX = Nominal voltage YY = Year of production	
Certifications	UL 1449 (E319264)	

Notes:

¹⁾ Specified in terms of corrosion against Sn-plating

²⁾ Tests according JEDEC J-STD-020

Surge arresters
2-electrode arresters
EHV6* series
Electrical specifications

Type	EHV6*- H25..	EHV6*- H30..	EHV6*- H36..	EHV6*- H40..	EHV6*- H45..	Unit
Nominal DC spark-over voltage ^{3) 4)}	2500	3000	3600	4000	4500	V
Tolerance	±20					%
Minimum	2000	2400	2880	3200	3600	V
Maximum	3000	3600	4320	4800	5400	V
Impulse spark-over voltage						
@ 100 V/μs for 99% of values typical values	< 3300 < 3000	< 3800 < 3400	< 4350 < 4150	< 5000 < 4600	< 5200 < 4800	V V
@ 1 kV/μs for 99% of values typical values	< 3400 < 3100	< 4000 < 3500	< 4500 < 4300	< 5400 < 4800	< 5500 < 5000	V V
@ 5 kV/μs for 99% of values typical values	< 3900 < 3400	< 4500 < 4000	< 5000 < 4500	< 5600 < 5000	< 6000 < 5500	V V
Service life						
300 operations 8/20 μs	100					A
3 operations 8/20 μs	3					kA
1 operation 8/20 μs	5					kA
Insulation resistance @ 100 V _{DC}	> 1					GΩ
Capacitance	< 1					pF
Arc voltage @ 1 A	~ 45	~ 45	~ 45	~ 50	~ 50	V
Glow to arc transition current	< 0.3	< 0.3	< 0.3	< 0.3	~ 0.3	A
Glow voltage @ 0.1 A	~ 240	~ 240	~ 240	~ 250	~ 250	V
AC withstand voltage (1 min) ⁵⁾	1250	1500	1800	2000	2250	V

Notes:

³⁾ At delivery AQL 0.65 level II, DIN ISO 2859

⁴⁾ In ionized mode

⁵⁾ AC withstand voltage still valid after service life

Terms and current waveforms in accordance with: ITU-T Rec. K. 12; IEC 61643-21; 61643-311; IEC 61663-2.

Surge arresters

2-electrode arresters

EHV6* series

Explanation of type:

1	2	3	4	5	6	7	8	9	10	11
E	H	V	6	2	-	H	3	6	B	2
↓ Product code				↓ High voltage			↓			
∅ wire		DC spark-over voltage				Bending style				
1	1.0 mm	e.g. 36 = 36 × 10 ² V = 3600 V				blank	straight wires			
2	0.8 mm					B...	bended for tray			
3	0.6 mm					T...	bended for tape			

Explanation of ordering code:

1	2	3	4	5	6	7	8	9	10	11	12	13	14	15				
B	8	8	0	6	9	X	1	6	8	3	S	1	0	2				
↓ Product group: Surge arresters							↓ Type code				↓							
							Packing				Packing unit							
							S	Stripes			Code		Pieces		Code		Pieces	
							T	Tape			101		10		252		250	
							B	Blister tray			102		100		253		2500	
							C	Bulk			103		1000		352		350	
											202		200		403		4000	
											203		2000		502		500	
											251		25		902		900	

Dimensions in mm and wire configurations

EHV6*-H...

Type	Ordering code
EHV62-H25	B88069X1893S102 / B88069X1893T502
EHV63-H25	B88069X2733S102 / B88069X2733T502
EHV63-H30	B88069X2553S102 / B88069X2553T502
EHV62-H36	B88069X1683S102 / B88069X1683T502
EHV63-H36	B88069X3003S102 / B88069X3003T502
EHV62-H40	B88069X2103S102 / B88069X2103T502
EHV63-H40	B88069X2563S102 / B88069X2563T502
EHV62-H45	B88069X1793S102 / B88069X1793T502
EHV63-H45	B88069X2573S102 / B88069X2573T502

wires tin-plated

EHV6*-H...B1

Type	Ordering code
EHV62-H36B1	B88069X2213B502

wires tin-plated

EHV6*-H...B2

Type	Ordering code
EHV63-H25B2	B88069X2023B502
EHV63-H30B2	B88069X2043B502
EHV62-H36B2	B88069X1693B502
EHV63-H36B2	B88069X2073B502
EHV63-H40B2	B88069X2633B502
EHV63-H45B2	B88069X2643B502

wires tin-plated

Surge arresters

2-electrode arresters

EHV6* series

EHV6*-H.. B7

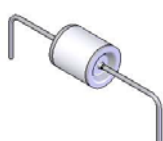
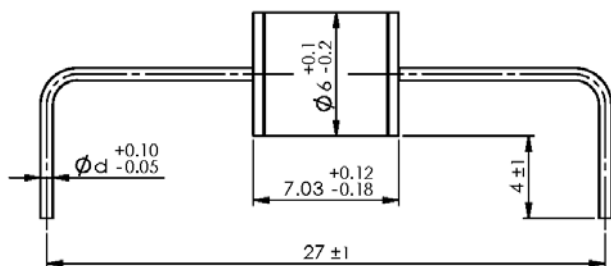

wires tin-plated

Type	Ordering code
EHV63-H30B7	B88069X2053B252
EHV63-H36B7	B88069X2083B252

EHV6*-H.. T7

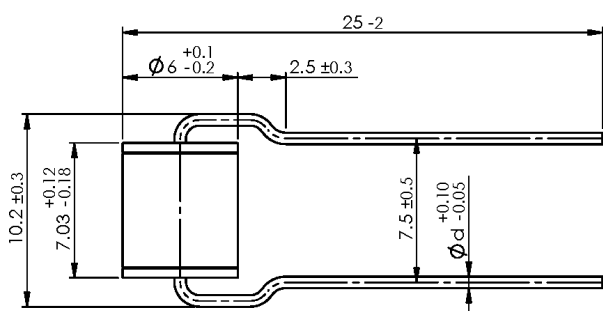

wires tin-plated

Type	Ordering code
EHV63-H25T7	B88069X2033A802
EHV63-H30T7	B88069X2063A802
EHV63-H36T7	B88069X2093A802
EHV63-H45T7	B88069X2953A802

Packing advices

<p>B88069X...S102 = 100 pcs. on 5 taped stripes</p>		
<p>B88069X...T502 = 500 pcs. on tape and reel</p>		

<p>B88069X...B502 = 500 pcs. on trays</p>	
--	--

<p>B88069X...B252 = 250 pcs. on trays</p>	
--	--

Surge arresters

2-electrode arresters

EHV6* series

B88069X...A802
= 800 pcs. in
ammo pack

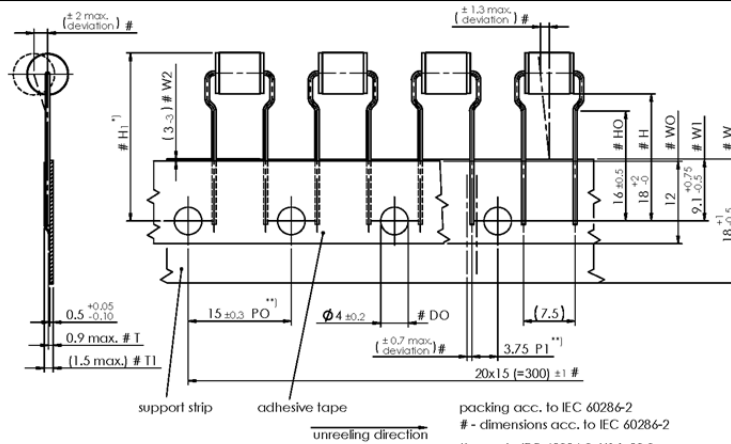

Tape force

- the extraction force for components in the tape plane, vertical to the direction of unreeling shall be ≥ 5 N
- break force of the tape ≥ 15 N

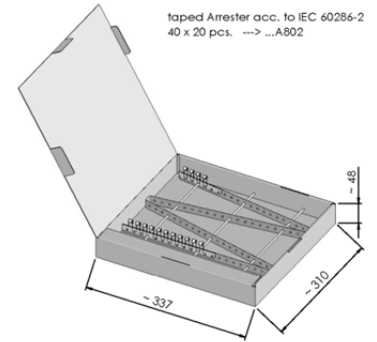

packing acc. to IEC 60286-2
- dimensions acc. to IEC 60286-2
*) acc. to IEC 60286-2, H1 is 32.2 mm max.
**) PO (15 mm) and P1 (3.75 mm) is customised,
upon request

Soldering parameter

Wave soldering

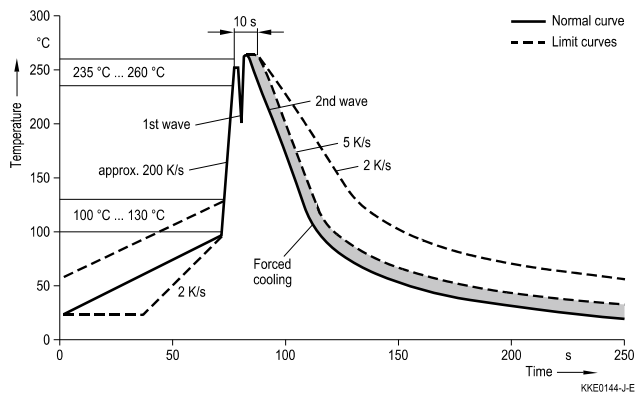

Wave profile feature	Pb-free assembly
Solder	Sn 95.5 / Ag 3.8 / Cu 0.7
Solder bath temperature	263 (± 3) °C
Dwell time	< 3 s

Soldering profile applied to a single soldering process.

Cautions and warnings

- Do not operate surge arresters in power supply networks, whose maximum operating voltage exceeds the minimum spark-over voltage of the surge arresters.
- Surge arresters may become hot in the event of longer periods of current stress (burn risk). In the event of overload the connectors may fail or the component may be destroyed.
- If the contacts of the surge arresters are defective, current load can cause sparks and loud noises.
- Surge arresters must be handled with care and must not be dropped.
- Do not continue to use damaged surge arresters.

Display of ordering codes for EPCOS products

The ordering code for one and the same EPCOS product can be represented differently in data sheets, data books, other publications, on the EPCOS website, or in order-related documents such as shipping notes, order confirmations and product labels. **The varying representations of the ordering codes are due to different processes employed and do not affect the specifications of the respective products.** Detailed information can be found on the Internet under www.epcos.com/orderingcodes

Important notes

The following applies to all products named in this publication:

1. Some parts of this publication contain **statements about the suitability of our products for certain areas of application**. These statements are based on our knowledge of typical requirements that are often placed on our products in the areas of application concerned. We nevertheless expressly point out **that such statements cannot be regarded as binding statements about the suitability of our products for a particular customer application**. As a rule, EPCOS is either unfamiliar with individual customer applications or less familiar with them than the customers themselves. For these reasons, it is always ultimately incumbent on the customer to check and decide whether an EPCOS product with the properties described in the product specification is suitable for use in a particular customer application.
2. We also point out that **in individual cases, a malfunction of electronic components or failure before the end of their usual service life cannot be completely ruled out in the current state of the art, even if they are operated as specified**. In customer applications requiring a very high level of operational safety and especially in customer applications in which the malfunction or failure of an electronic component could endanger human life or health (e.g. in accident prevention or life-saving systems), it must therefore be ensured by means of suitable design of the customer application or other action taken by the customer (e.g. installation of protective circuitry or redundancy) that no injury or damage is sustained by third parties in the event of malfunction or failure of an electronic component.
3. **The warnings, cautions and product-specific notes must be observed.**
4. In order to satisfy certain technical requirements, **some of the products described in this publication may contain substances subject to restrictions in certain jurisdictions (e.g. because they are classed as hazardous)**. Useful information on this will be found in our Material Data Sheets on the Internet (www.epcos.com/material). Should you have any more detailed questions, please contact our sales offices.
5. We constantly strive to improve our products. Consequently, **the products described in this publication may change from time to time**. The same is true of the corresponding product specifications. Please check therefore to what extent product descriptions and specifications contained in this publication are still applicable before or when you place an order. We also **reserve the right to discontinue production and delivery of products**. Consequently, we cannot guarantee that all products named in this publication will always be available. The aforementioned does not apply in the case of individual agreements deviating from the foregoing for customer-specific products.
6. Unless otherwise agreed in individual contracts, **all orders are subject to the current version of the "General Terms of Delivery for Products and Services in the Electrical Industry" published by the German Electrical and Electronics Industry Association (ZVEI)**.
7. The trade names EPCOS, Alu-X, CeraDiode, CeraLink, CeraPlas, CSMP, CSSP, CTVS, DeltaCap, DigiSiMic, DSSP, FilterCap, FormFit, LeaXield, MiniBlue, MiniCell, MKD, MKK, MLSC, MotorCap, PCC, PhaseCap, PhaseCube, PhaseMod, PhiCap, PQSine, SIFERRIT, SIFI, SIKOREL, SilverCap, SIMDAD, SiMic, SIMID, SineFormer, SIOV, SIP5D, SIP5K, TFAP, ThermoFuse, WindCap are **trademarks registered or pending** in Europe and in other countries. Further information will be found on the Internet at www.epcos.com/trademarks.

Mouser Electronics

Authorized Distributor

Click to View Pricing, Inventory, Delivery & Lifecycle Information:

[EPCOS / TDK:](#)

[B88069X0210S102](#)