

# PLCC4 Surface Mount LED

## OVSA1xBC2R8 Series



### Features:

- High intensity with low power consumption
- PLCC4 packaged in 8 mm tape on 7" diameter reel
- Compatible with automatic placement equipment
- Dimensions: 3.2 x 2.7 x 1.95 mm
- 120° viewing angle



### Description:

The OVSA1xBC2R8 series is designed for wide angle, uniform light output. Its internal reflector and colorless clear lens optimize luminous intensity and make it ideal for backlighting applications and for coupling with light guides.

### Applications:

- Traffic lights
- Signal and symbol luminaire
- Mono-color indicators
- Backlighting (LCD, switches, displays, illuminated advertising)
- Interior automotive lighting (instrumentation clusters)
- Safety marker lights (steps, exit ways)

| Part Number | Material | Emitted Color | Intensity Typ. mcd | Lens Color  |
|-------------|----------|---------------|--------------------|-------------|
| OVSA1ABC2R8 | AllnGaP  | Amber         | 1500               | Water Clear |
| OVSA1BBC2R8 | InGaN    | Blue          | 650                | Water Clear |
| OVSA1GBC2R8 | InGaN    | Green         | 3200               | Water Clear |
| OVSA1SBC2R8 | AllnGaP  | Red           | 1600               | Water Clear |

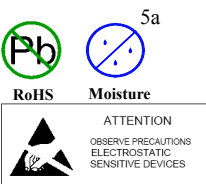
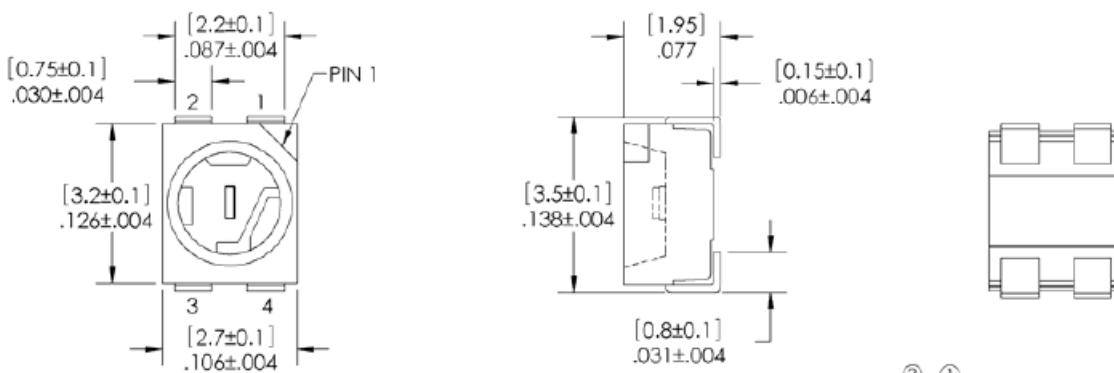

DIMENSIONS ARE IN INCHES AND [MM]

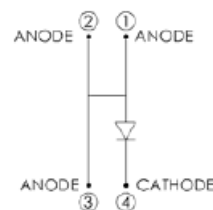

**DO NOT LOOK DIRECTLY AT LED WITH UNSHIELDED EYES OR DAMAGE TO RETINA MAY**

### General Note

TT Electronics reserves the right to make changes in product specification without notice or liability. All information is subject to TT Electronics' own data and is considered accurate at time of going to print.

TT Electronics | Optek Technology, Inc.  
 1645 Wallace Drive, Ste. 130, Carrollton, TX USA 75006 | Ph: +1 972 323 2200  
 www.ttelectronics.com | sensors@ttelectronics.com

### Electrical Specifications

| Absolute Maximum Ratings (T <sub>A</sub> = 25° C unless otherwise noted) |             |                     |
|--------------------------------------------------------------------------|-------------|---------------------|
| Storage Temperature Range                                                |             | -40 ~ +100 °C       |
| Operating Temperature Range                                              |             | -40 ~ +100 °C       |
| Reverse Voltage                                                          |             | 5 V                 |
| Continuous Forward Current                                               | Blue, Green | 30 mA               |
|                                                                          | Red, Amber  | 70 mA               |
| Peak Forward Current (Pulse width ≤10 msec, duty cycle ≤10%)             | Blue, Green | 100 mA              |
|                                                                          | Red, Amber  | 200 mA              |
| Power Dissipation                                                        | Blue, Green | 130 mW              |
|                                                                          | Red, Amber  | 210 mW              |
| Thermal Resistance Junction to Solder <sup>1.</sup>                      | Blue, Green | 200° C/W            |
|                                                                          | Red, Amber  | 150° C/W            |
| Electrostatic Discharge Classification (MIL-STD-883E)                    | Blue, Green | Class 2             |
|                                                                          | Red, Amber  |                     |
| Moisture Sensitivity Level (IPC/JEDEC J-STD-020C)                        |             | 5a / 24 hrs         |
| LED Junction Temperature                                                 |             | 110° C              |
| Lead Soldering Temperature                                               |             | 250° C / 10 seconds |

Note:

1. R<sub>th</sub> test condition: Mounted on PC board FR 4 (pad size ≥ 16 mm<sup>2</sup>)

### Electrical Characteristics (T<sub>A</sub> = 25° C unless otherwise noted)

| SYMBOL             | PARAMETER           | COLOR        | MIN  | TYP  | MAX  | UNITS | CONDITIONS             |
|--------------------|---------------------|--------------|------|------|------|-------|------------------------|
| I <sub>v</sub>     | Luminous Intensity  | Blue         | 450  | 650  | ---- | mcd   | I <sub>F</sub> = 30 mA |
|                    |                     | Green        | 2240 | 3200 | ---- |       |                        |
|                    |                     | Red          | 1120 | 1600 | ---- |       | I <sub>F</sub> = 50 mA |
|                    |                     | Amber        | 1120 | 1500 | ---- |       |                        |
| V <sub>F</sub>     | Forward Voltage     | Blue         | ---- | 3.6  | 4.2  | V     | I <sub>F</sub> = 30 mA |
|                    |                     | Green        | ---- | 3.6  | 4.2  |       |                        |
|                    |                     | Red          | ---- | 2.4  | 3.0  |       | I <sub>F</sub> = 50 mA |
|                    |                     | Amber        | ---- | 2.4  | 3.0  |       |                        |
| I <sub>R</sub>     | Reverse Current     | Blue         | ---- | ---- | 10   | μA    | V <sub>R</sub> = 5 V   |
|                    |                     | Green        | ---- | ---- | 10   |       |                        |
|                    |                     | Red          | ---- | ---- | 10   |       |                        |
|                    |                     | Amber        | ---- | ---- | 10   |       |                        |
| λ <sub>D</sub>     | Dominant Wavelength | Blue         | 460  | 470  | 475  | nm    | I <sub>F</sub> = 30 mA |
|                    |                     | Green        | 520  | 527  | 535  |       | I <sub>F</sub> = 50 mA |
|                    |                     | Red          | 618  | 624  | 630  |       |                        |
|                    |                     | Amber        | 584  | 591  | 599  |       |                        |
| 2Θ <sub>½H-H</sub> | 50% Power Angle     | Blue & Green |      | 120  |      | deg   | I <sub>F</sub> = 30 mA |
|                    |                     | Red & Amber  |      |      |      |       | I <sub>F</sub> = 50 mA |

General Note

TT Electronics reserves the right to make changes in product specification without notice or liability. All information is subject to TT Electronics' own data and is considered accurate at time of going to print.

TT Electronics | Optek Technology, Inc.  
 1645 Wallace Drive, Ste. 130, Carrollton, TX USA 75006 | Ph: +1 972 323 2200  
[www.ttelectronics.com](http://www.ttelectronics.com) | [sensors@ttelectronics.com](mailto:sensors@ttelectronics.com)

Luminous Intensity ( $I_v$ ) @ 30mA

| BLUE: OVSA1BBC2R8 |           |           |
|-------------------|-----------|-----------|
| IV Code           | Min (mcd) | Max (mcd) |
| Ua                | 450       | 560       |
| Ub                | 560       | 710       |
| Va                | 710       | 900       |

Dominant Wavelength (nm)

| BLUE: OVSA1BBC2R8 |     |     |
|-------------------|-----|-----|
| nm Code           | Min | Max |
| B3                | 460 | 465 |
| B4                | 465 | 470 |
| B5                | 470 | 475 |

| GREEN: OVSA1GBC2R8 |           |           |
|--------------------|-----------|-----------|
| IV Code            | Min (mcd) | Max (mcd) |
| Xb                 | 2240      | 2800      |
| Ya                 | 2800      | 3550      |
| Yb                 | 3550      | 4500      |

| GREEN: OVSA1GBC2R8 |     |     |
|--------------------|-----|-----|
| nm Code            | Min | Max |
| G7                 | 520 | 525 |
| G8                 | 525 | 530 |
| G9                 | 530 | 535 |

Luminous Intensity ( $I_v$ ) @ 50mA

| RED: OVSA1SBC2R8 |           |           |
|------------------|-----------|-----------|
| IV Code          | Min (mcd) | Max (mcd) |
| Wa               | 1120      | 1400      |
| Wb               | 1400      | 1800      |
| Xa               | 1800      | 2240      |
| Xb               | 2240      | 2800      |

Dominant Wavelength (nm)

| RED: OVSA1SBC2R8 |     |     |
|------------------|-----|-----|
| nm Code          | Min | Max |
| RA               | 618 | 630 |

| AMBER: OVSA1ABC2R8 |           |           |
|--------------------|-----------|-----------|
| IV Code            | Min (mcd) | Max (mcd) |
| Wa                 | 1120      | 1400      |
| Wb                 | 1400      | 1800      |
| Xa                 | 1800      | 2240      |
| Xb                 | 2240      | 2800      |

| AMBER: OVSA1ABC2R8 |     |     |
|--------------------|-----|-----|
| nm Code            | Min | Max |
| A2                 | 584 | 587 |
| A3                 | 587 | 590 |
| A4                 | 590 | 593 |
| A5                 | 593 | 596 |
| A6                 | 596 | 599 |

General Note

TT Electronics reserves the right to make changes in product specification without notice or liability. All information is subject to TT Electronics' own data and is considered accurate at time of going to print.

TT Electronics | Optek Technology, Inc.  
 1645 Wallace Drive, Ste. 130, Carrollton, TX USA 75006 | Ph: +1 972 323 2200  
[www.ttelectronics.com](http://www.ttelectronics.com) | [sensors@ttelectronics.com](mailto:sensors@ttelectronics.com)

### Typical Electro-Optical Characteristics Curves OVSA1BBC2R8 (Blue) & OVSA1GBC2R8 (Green)

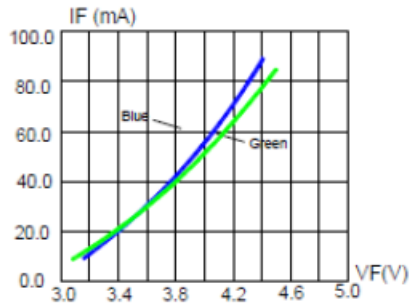

Forward Current vs. Forward Voltage

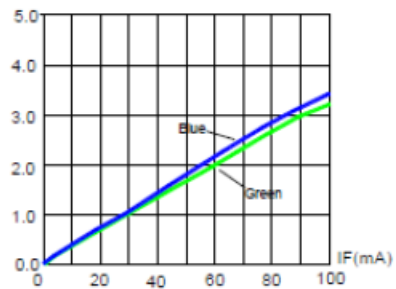

Relative Luminous Intensity vs. Forward Current

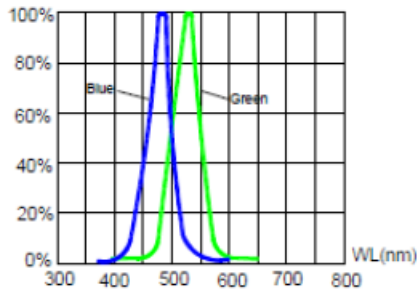

Relative Luminous Intensity vs. Wavelength

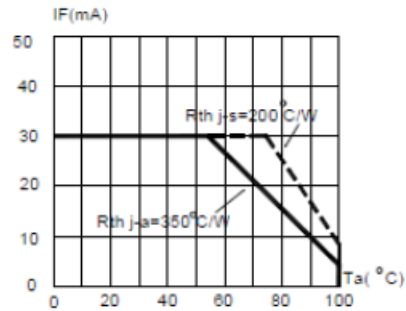

Blue & Green Maximum Forward DC Current vs. Ambient Temperature

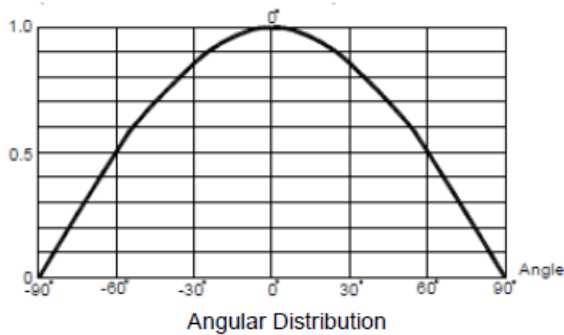

Angular Distribution

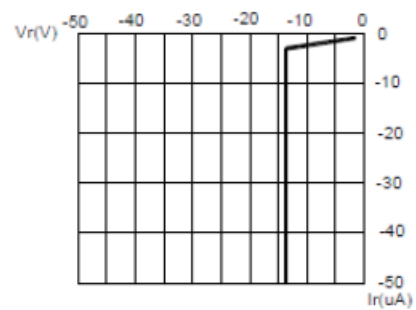

Blue & Green Reverse Current vs. Reverse Voltage

General Note  
 TT Electronics reserves the right to make changes in product specification without notice or liability. All information is subject to TT Electronics' own data and is considered accurate at time of going to print.

### Typical Electro-Optical Characteristics Curves for OVSA1SBC2R8 (Red) & OVSA1ABC2R8 (Amber)

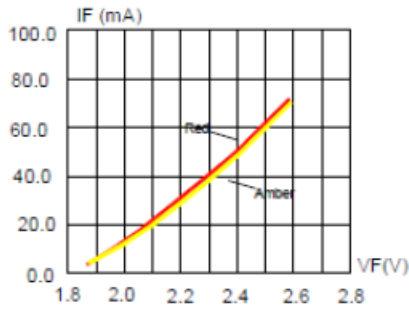

Forward Current vs. Forward Voltage

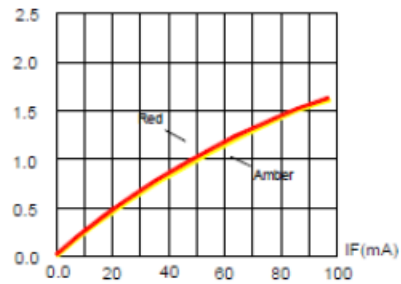

Relative Luminous Intensity vs. Forward Current

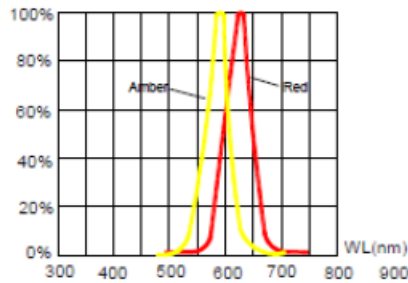

Relative Luminous Intensity vs. Wavelength

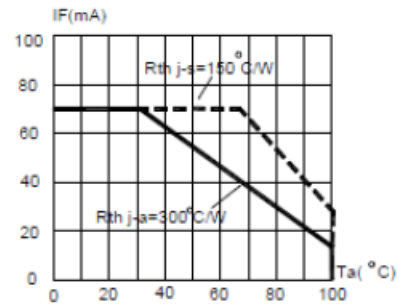

Red & Amber Maximum Forward DC Current vs. Ambient Temperature

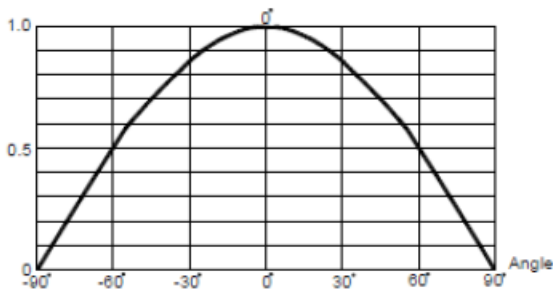

Angular Distribution

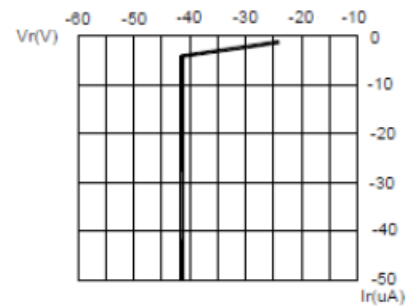

Red & Amber Reverse Current vs. Reverse Voltage

General Note  
 TT Electronics reserves the right to make changes in product specification without notice or liability. All information is subject to TT Electronics' own data and is considered accurate at time of going to print.

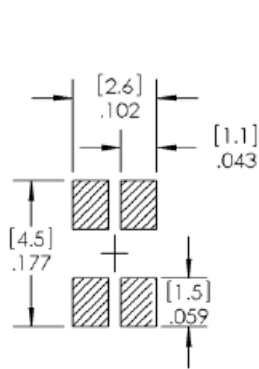

RECOMMENDED SOLDER PASTE PATTERN

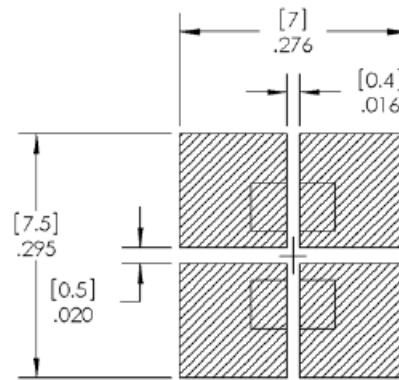

RECOMMENDED COPPER PATTERN

### Reflow Solder Profile

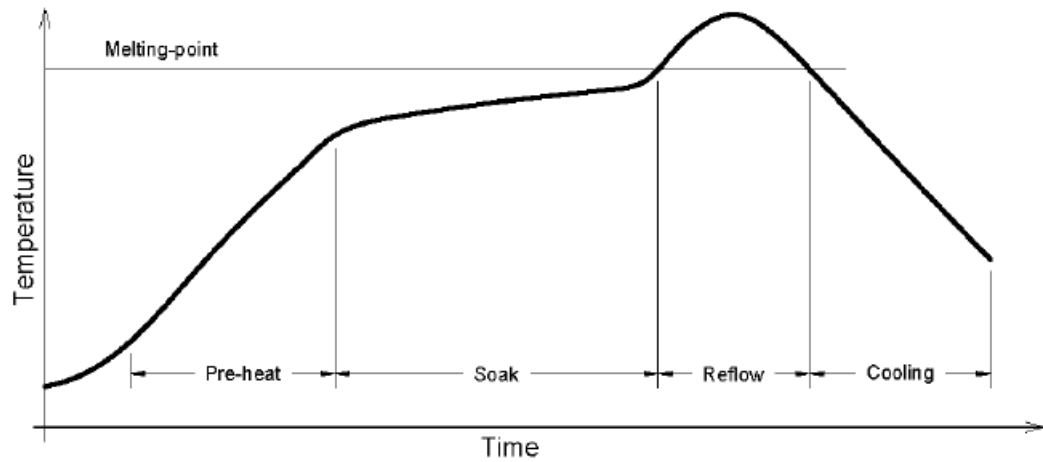

| Solder = Lead-Free                    |                                                          |
|---------------------------------------|----------------------------------------------------------|
| Average ramp-up rate = 4°C / sec. max | Peak temperature = 250°C max.                            |
| Preheat temperature: 150 - 220°C      | Time within 5°C of actual peak temperature = 10 sec. max |
| Preheat time: 120 sec. max.           |                                                          |
| Ramp-down rate = 6°C / sec. max.      | Duration above 217°C is 60 sec. max                      |

Reel Dimensions: 7-inch reel

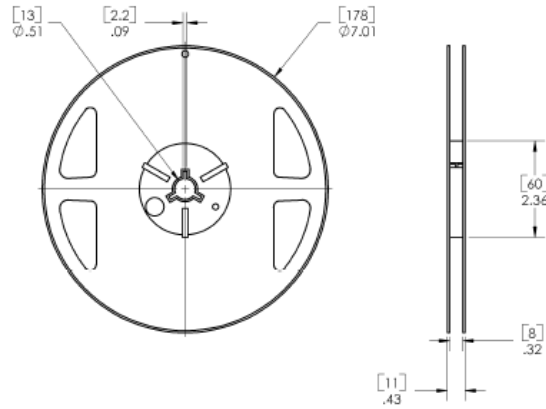

Carrier Tape Dimensions: Loaded Quantity 2000 pieces per reel

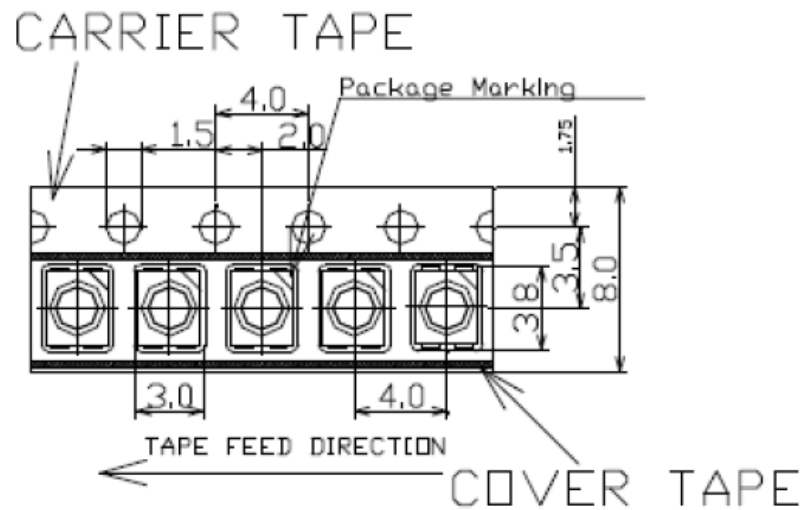

Moisture Resistant Packaging:

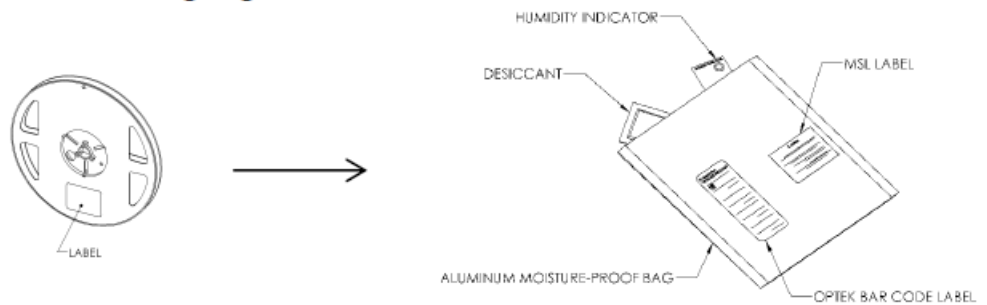

General Note  
 TT Electronics reserves the right to make changes in product specification without notice or liability. All information is subject to TT Electronics' own data and is considered accurate at time of going to print.