

Ø 172x51 mm

San Ace 172 9E type   

Round type



General Specifications

- Material Frame: Aluminum, Impeller: Plastic (Flammability: UL 94V-1)
- Expected life See the table below. (L10 life: 90% survival rate for continuous operation in free air at 60°C, rated voltage)
- Motor protection function Locked rotor burnout protection, Reverse polarity protection
For details, please refer to p. 547.
- Dielectric strength 50/60 Hz, 500 VAC, for 1 minute (between lead wire conductors and frame)
- Insulation resistance 10 MΩ or more with a 500 VDC megger (between lead wire conductors and frame)
- Sound pressure level (SPL) At 1 m away from the air inlet
- Storage temperature -30 to +70°C (Non-condensing)
- Lead wire ⊕Red ⊖Black or Blue (Sensor) Yellow
- Mass 780 g

Specifications

The models listed below **have pulse sensors**.

Model no.	Rated voltage [V]	Operating voltage range [V]	Rated current [A]	Rated input [W]	Rated speed [min ⁻¹]	Max. airflow [m ³ /min] [CFM]	Max. static pressure [Pa] [inchH ₂ O]	SPL [dB (A)]	Operating temperature [°C]	Expected life [h]
109E1712K501	12	10.2 to 13.8	2.9	34.8	4100	8.5 300	243.0 0.976	55	-20 to +60	40000/60°C
109E1712Y501			2.3	27.6	3800	7.8 276	210.0 0.843	53		
109E1712H501			1.2	14.4	3050	6.4 226	137.2 0.551	47		
109E1712F501			0.68	10.8	2500	5.1 180	95.0 0.382	42		
109E1712M501			0.48	5.76	2000	4.2 148	67.6 0.271	36		
109E1724C501	24	20.4 to 27.6	2.3	55.2	4800	9.9 350	308.0 1.237	60	-20 to +70	
109E1724K501			1.3	31.2	4100	8.5 300	243.0 0.976	55		
109E1724H501			0.58	13.92	3050	6.4 226	137.2 0.551	47		
109E1724F501			0.35	8.4	2500	5.1 180	95 0.382	42		
109E1724M501			0.2	4.8	2000	4.2 148	67.6 0.271	36		
109E1748C501	48	40.8 to 55.2	1.2	57.6	4800	9.9 350	308.0 1.237	60	-20 to +60	
109E1748K501			0.7	33.6	4100	8.5 300	243.0 0.976	55		
109E1748H501			0.28	13.44	3050	6.4 226	137.2 0.551	47		
109E1748F501			0.19	9.12	2500	5.1 180	95 0.382	42		
109E1748M501			0.11	5.28	2000	4.2 148	67.6 0.271	36		

The following sensor and control options are available for selection.

Available for all models. **Without sensor**

Differs according to the model. Refer to the table on p. 561. **Lock sensor** **PWM control**

Airflow - Static Pressure Characteristics

109E1712K501 With pulse sensor

Operating voltage range



109E1712Y501 With pulse sensor

Operating voltage range

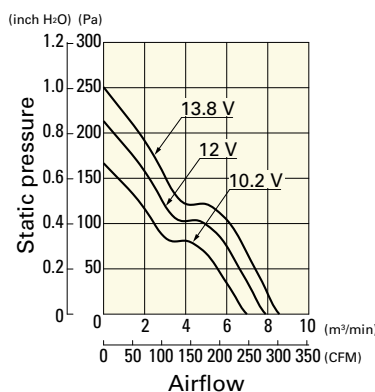

109E1712H501 With pulse sensor

Operating voltage range

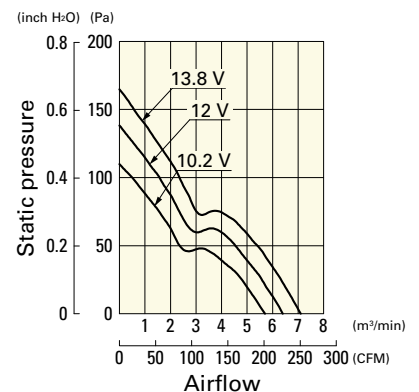

Airflow - Static Pressure Characteristics

109E1712F501 With pulse sensor

Operating voltage range



109E1712M501 With pulse sensor

Operating voltage range



109E1724C501 With pulse sensor

Operating voltage range



109E1724K501 With pulse sensor

Operating voltage range



109E1724H501 With pulse sensor

Operating voltage range



109E1724F501 With pulse sensor

Operating voltage range

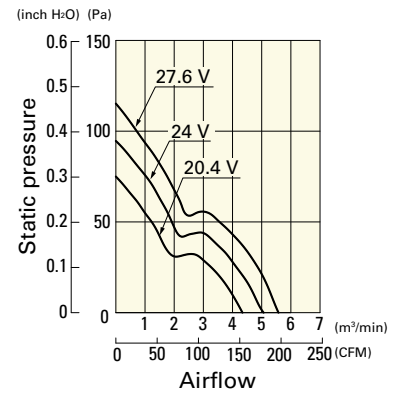

109E1724M501 With pulse sensor

Operating voltage range



109E1748C501 With pulse sensor

Operating voltage range

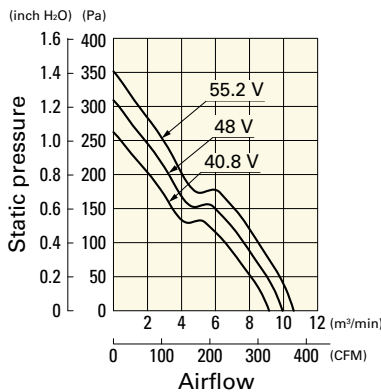

109E1748K501 With pulse sensor

Operating voltage range

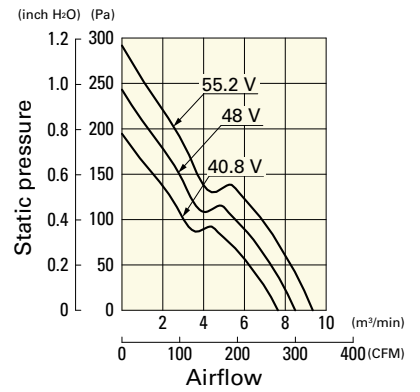

109E1748H501 With pulse sensor

Operating voltage range

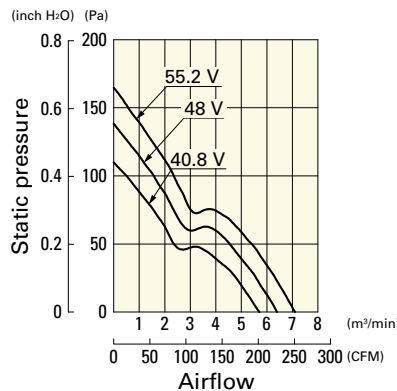

109E1748F501 With pulse sensor

Operating voltage range

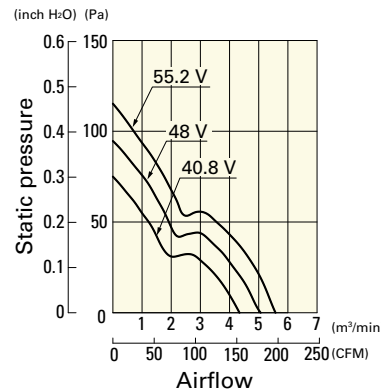

109E1748M501 With pulse sensor

Operating voltage range



Dimensions (unit: mm)



Reference Dimensions of Mounting Holes and Vent Opening (unit: mm)

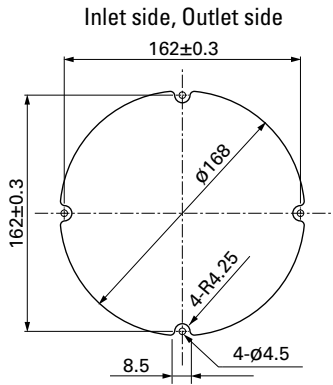

Options

Finger guards

page: p. 534

Model no.: 109-1066, 109-1068, 109-319E, 109-319H,
109-320