

# Ø 172x51 mm

San Ace 172 9E type   

Round type



## General Specifications

- Material ..... Frame: Aluminum, Impeller: Plastic (Flammability: UL 94V-1)
- Expected life ..... See the table below. (L10 life: 90% survival rate for continuous operation in free air at 60°C, rated voltage)
- Motor protection function ..... Locked rotor burnout protection, Reverse polarity protection  
For details, please refer to p. 547.
- Dielectric strength ..... 50/60 Hz, 500 VAC, for 1 minute (between lead wire conductors and frame)
- Insulation resistance ..... 10 MΩ or more with a 500 VDC megger (between lead wire conductors and frame)
- Sound pressure level (SPL) ..... At 1 m away from the air inlet
- Storage temperature ..... -30 to +70°C (Non-condensing)
- Lead wire ..... ⊕Red ⊖Black or Blue (Sensor) Yellow
- Mass ..... 780 g

## Specifications

The models listed below **have pulse sensors**.

Model no.	Rated voltage [V]	Operating voltage range [V]	Rated current [A]	Rated input [W]	Rated speed [min <sup>-1</sup> ]	Max. airflow [m <sup>3</sup> /min] [CFM]	Max. static pressure [Pa] [inchH <sub>2</sub> O]	SPL [dB (A)]	Operating temperature [°C]	Expected life [h]
<b>109E1712K501</b>	12	10.2 to 13.8	2.9	34.8	4100	8.5 300	243.0 0.976	55	-20 to +60	40000/60°C
<b>109E1712Y501</b>			2.3	27.6	3800	7.8 276	210.0 0.843	53		
<b>109E1712H501</b>			1.2	14.4	3050	6.4 226	137.2 0.551	47		
<b>109E1712F501</b>			0.68	10.8	2500	5.1 180	95.0 0.382	42		
<b>109E1712M501</b>			0.48	5.76	2000	4.2 148	67.6 0.271	36		
<b>109E1724C501</b>	24	20.4 to 27.6	2.3	55.2	4800	9.9 350	308.0 1.237	60	-20 to +70	
<b>109E1724K501</b>			1.3	31.2	4100	8.5 300	243.0 0.976	55		
<b>109E1724H501</b>			0.58	13.92	3050	6.4 226	137.2 0.551	47		
<b>109E1724F501</b>			0.35	8.4	2500	5.1 180	95 0.382	42		
<b>109E1724M501</b>			0.2	4.8	2000	4.2 148	67.6 0.271	36		
<b>109E1748C501</b>	48	40.8 to 55.2	1.2	57.6	4800	9.9 350	308.0 1.237	60	-20 to +60	
<b>109E1748K501</b>			0.7	33.6	4100	8.5 300	243.0 0.976	55		
<b>109E1748H501</b>			0.28	13.44	3050	6.4 226	137.2 0.551	47		
<b>109E1748F501</b>			0.19	9.12	2500	5.1 180	95 0.382	42		
<b>109E1748M501</b>			0.11	5.28	2000	4.2 148	67.6 0.271	36		

The following sensor and control options are available for selection.

Available for all models. **Without sensor**

Differs according to the model. Refer to the table on p. 561. **Lock sensor** **PWM control**

## Airflow - Static Pressure Characteristics

**109E1712K501** With pulse sensor

Operating voltage range



**109E1712Y501** With pulse sensor

Operating voltage range

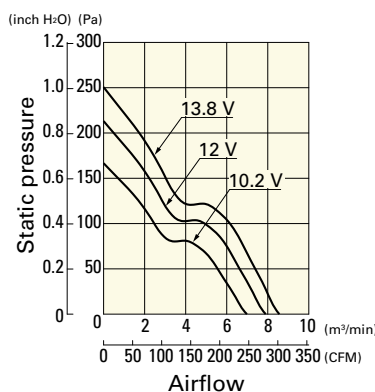

**109E1712H501** With pulse sensor

Operating voltage range

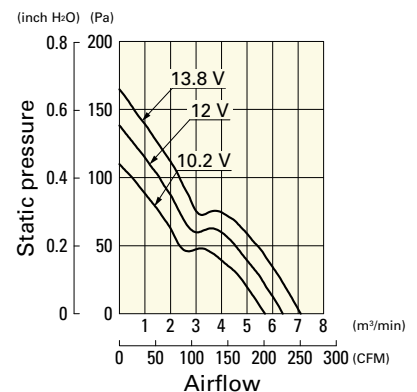

# Airflow - Static Pressure Characteristics

**109E1712F501** With pulse sensor

Operating voltage range

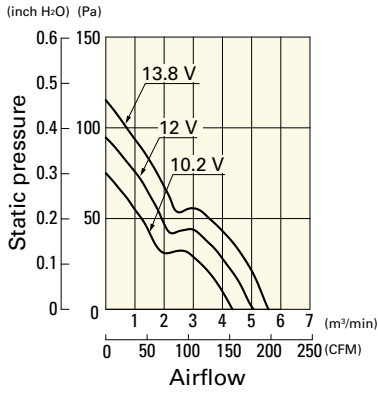

**109E1712M501** With pulse sensor

Operating voltage range

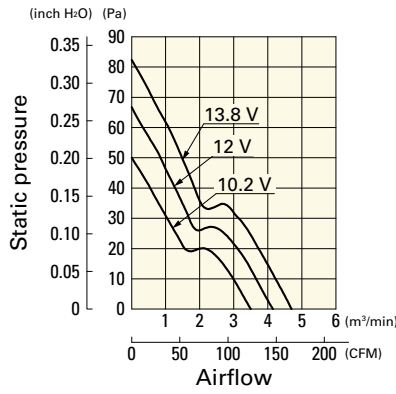

**109E1724C501** With pulse sensor

Operating voltage range

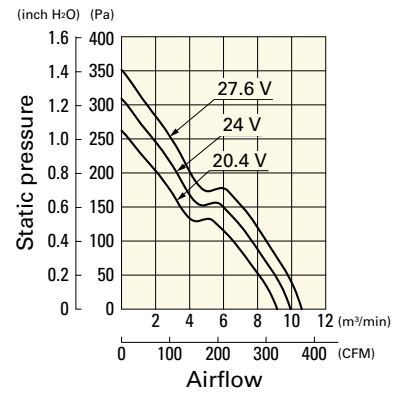

**109E1724K501** With pulse sensor

Operating voltage range

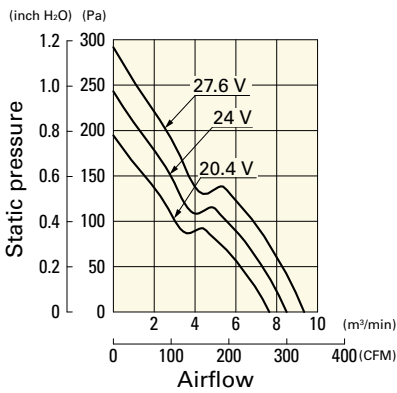

**109E1724H501** With pulse sensor

Operating voltage range

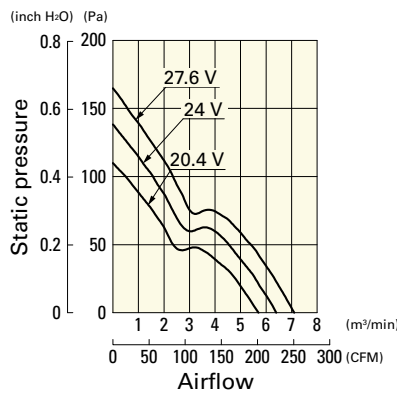

**109E1724F501** With pulse sensor

Operating voltage range

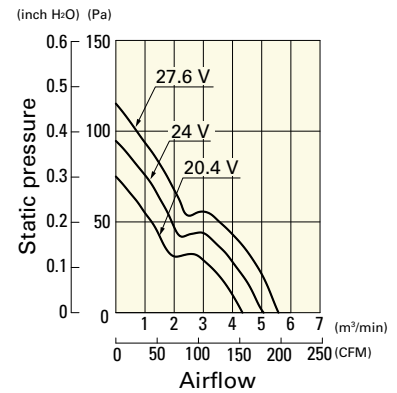

**109E1724M501** With pulse sensor

Operating voltage range

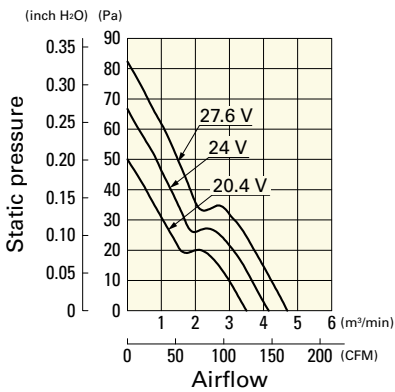

**109E1748C501** With pulse sensor

Operating voltage range

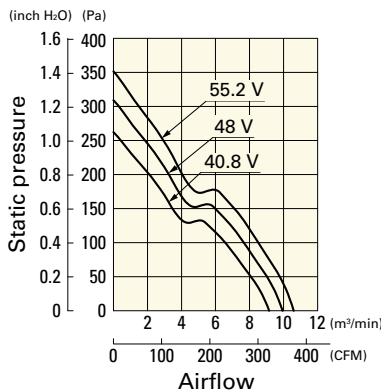

**109E1748K501** With pulse sensor

Operating voltage range

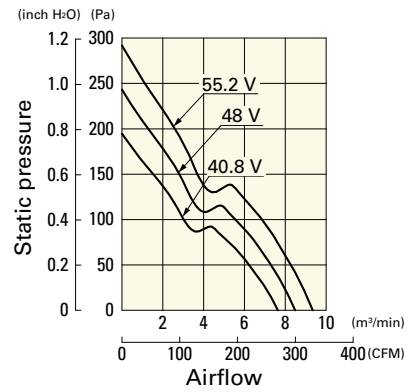

**109E1748H501** With pulse sensor

Operating voltage range

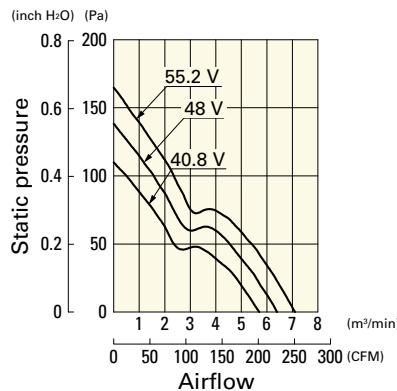

**109E1748F501** With pulse sensor

Operating voltage range

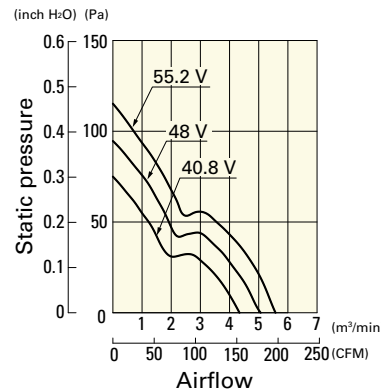

**109E1748M501** With pulse sensor

Operating voltage range

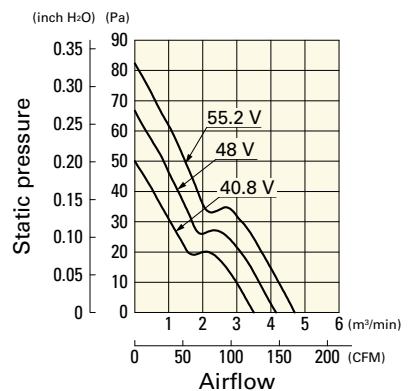

## ■ Dimensions (unit: mm)

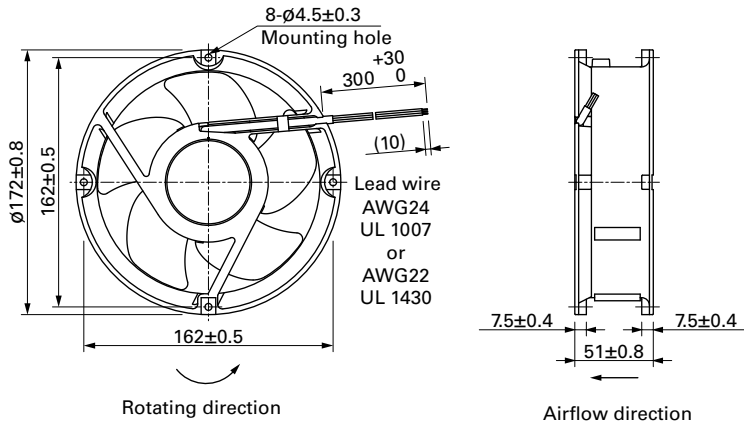

## ■ Reference Dimensions of Mounting Holes and Vent Opening (unit: mm)

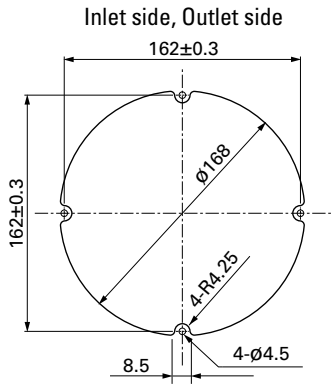

## ■ Options

### Finger guards

page: p. 534

Model no.: 109-1066, 109-1068, 109-319E, 109-319H,  
109-320