



Features

- 8.5V Single Supply
- 5MHz to 2500MHz Operation
- Gain: 14.5dB at 500MHz
- OIP3: 42dBm at 500MHz
- Noise Figure: 3.7dB at 500MHz
- SOT-89 Package

Applications

- CATV Distribution Amplifiers
- Cable Modems
- Broadband Cable Blocks
- Laser Diode Driver
- Return Channel Amplifier

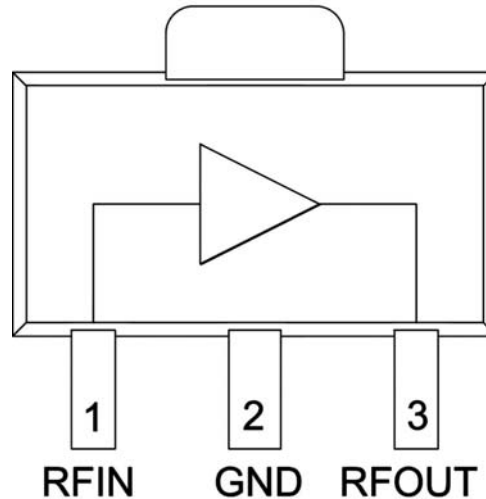

Functional Block Diagram

Product Description

RFMD's RFCA3310 is a low-cost 75Ω cascadable gain block MMIC amplifier. Its gain flatness and high linearity make it ideal for cable TV applications. The RFCA3310 is manufactured on a proven RFMD GaAs HBT process.

Ordering Information

| | |
|-----------------|---|
| RFCA3310SQ | 25 piece sample bag |
| RFCA3310SR | 7" Sample reel with 100 pieces |
| RFCA3310TR13 | 13" Reel with 2500 pieces |
| RFCA3310PCK-410 | 5MHz to 2500MHz, PCBA with 5-piece sample bag |

Optimum Technology Matching® Applied

- | | | | |
|--|--------------------------------------|-------------------------------------|------------------------------------|
| <input checked="" type="checkbox"/> GaAs HBT | <input type="checkbox"/> SiGe BiCMOS | <input type="checkbox"/> GaAs pHEMT | <input type="checkbox"/> GaN HEMT |
| <input type="checkbox"/> GaAs MESFET | <input type="checkbox"/> Si BiCMOS | <input type="checkbox"/> Si CMOS | <input type="checkbox"/> BiFET HBT |
| <input type="checkbox"/> InGaP HBT | <input type="checkbox"/> SiGe HBT | <input type="checkbox"/> Si BJT | <input type="checkbox"/> SOI |

RF MICRO DEVICES®, RFMD®, Optimum Technology Matching®, Enabling Wireless Connectivity™, PowerStar®, POLARIS™ TOTAL RADIO™ and UltimateBlue™ are trademarks of RFMD, LLC. BLUETOOTH is a trademark owned by Bluetooth SIG, Inc., U.S.A. and licensed for use by RFMD. All other trade names, trademarks and registered trademarks are the property of their respective owners. ©2012, RF Micro Devices, Inc.

Absolute Maximum Ratings

| Parameter | Rating | Unit |
|---------------------------------------|-------------|------|
| Max Device Current (I_D) | 170 | mA |
| Max Device Voltage (V_D) | 9 | V |
| CW RF Input Power, 50 output VSWR | 18 | dBm |
| Max Operating Junction Temp (T_J) | 165 | °C |
| Operating Temperature Range (T_L) | -40 to +85 | °C |
| Storage Temperature | -40 to +150 | °C |
| ESD Rating - Human Body Model | Class 0 | |
| Moisture Sensitivity Level | MSL2 | |



Caution! ESD sensitive device.

Exceeding any one or a combination of the Absolute Maximum Rating conditions may cause permanent damage to the device. Extended application of Absolute Maximum Rating conditions to the device may reduce device reliability. Specified typical performance or functional operation of the device under Absolute Maximum Rating conditions is not implied.

The information in this publication is believed to be accurate and reliable. However, no responsibility is assumed by RF Micro Devices, Inc. ("RFMD") for its use, nor for any infringement of patents, or other rights of third parties, resulting from its use. No license is granted by implication or otherwise under any patent or patent rights of RFMD. RFMD reserves the right to change component circuitry, recommended application circuitry and specifications at any time without prior notice.



RFMD Green: RoHS compliant per EU Directive 2002/95/EC, halogen free per IEC 61249-2-21, < 1000ppm each of antimony trioxide in polymeric materials and red phosphorus as a flame retardant, and <2% antimony in solder.

Notes:

1. The maximum ratings must all be met simultaneously.
2. $P_{DISS} = P_{DC} + R_{RFIN} - R_{RFOUT}$
3. $T_J = T_L + P_{DISS} * R_{TH}$

| Parameter | Specification | | | Unit | Condition |
|---|--|------|------|------|---|
| | Min. | Typ. | Max. | | |
| Downstream Performance Overall (75Ω) | | | | | 50MHz to 1000MHz Application, $V_D = 8.5V$, $I_D = 147mA$, $T_L = 25°C$, $Z_S = Z_L = 75Ω$ |
| Frequency Range | 50 | | 1000 | MHz | |
| Small Signal Gain at 50MHz | 14.3 | 14.9 | 15.7 | dB | |
| Small Signal Gain at 500MHz | 14 | 14.5 | 15.4 | dB | |
| Small Signal Gain at 1000MHz | 13.6 | 14 | 15 | dB | |
| Gain Flatness | -0.9 | -0.7 | -0.3 | dB | |
| P1dB | | 22 | | dBm | |
| Noise Figure | | 3.6 | | dB | |
| Input Return Loss | | 20 | | dB | 50MHz |
| | | 7.7 | | dB | 1000MHz |
| Output Return Loss | | 16 | | dB | 50MHz |
| | | 9 | | dB | 1000MHz |
| Stability Factor | Conditional Stability (see plot for details) | | | | 50Ω EVB and S-parameter calibration |
| Output IP3 | 41.5 | 45 | | dBm | 50MHz, Tone spacing = 6MHz, P_{OUT} per Tone = +5dBm |
| | 30 | 33.5 | | dBm | 1000MHz, Tone spacing = 6MHz, P_{OUT} per Tone = +5dBm |
| Output IP2 | | 66 | | dBm | 50MHz, Tone spacing = 30MHz, P_{OUT} per Tone = +0dBm |
| | | 46.5 | | dBm | 1000MHz, Tone spacing = 30MHz, P_{OUT} per Tone = +0dBm |
| CSO | | 63 | | dBc | 79 Channels to 550MHz, +29dBmV out |
| CTB | | 92 | | dBc | |
| XMOD | | 89 | | dBc | |

| Parameter | Specification | | | Unit | Condition |
|------------------------------------|---|------|------|--------------|--|
| | Min. | Typ. | Max. | | |
| Upstream Performance (75Ω) | | | | | 5MHz to 200MHz Application, $V_D=8.5V$, $I_D=142mA$, $T_L = 25^\circ C$, $Z_S = Z_L = 75\Omega$ |
| Frequency Range | 5 | | 200 | MHz | |
| Small Signal Gain at 5MHz | 14.5 | 14.6 | 15.5 | dB | |
| Small Signal Gain at 50MHz | 14.2 | 14.9 | 15.2 | dB | |
| Small Signal Gain at 200MHz | 14 | 14.6 | 15 | dB | |
| Gain Flatness | | 0 | | dB | |
| P1dB | | 23.5 | | dBm | |
| Noise Figure | | 3.7 | | dB | |
| Input Return Loss | | 26 | | dB | 50MHz |
| Output Return Loss | | 18 | | dB | 50MHz |
| Stability Factor | Conditional Stability (see plot for details) | | | | 50Ω EVB and S-parameter calibration |
| Output IP3 | | 47 | | dBm | 13MHz, Tone Spacing=6MHz, P_{OUT} per Tone = +6.25dBm |
| Output IP2 | | 68 | | dBm | |
| CSO | | 61 | | dBc | 7 Channel to 50MHz, +49.5dBmV out |
| CTB | | 84 | | dBc | |
| XMOD | | 80 | | dBc | |
| Power Supply | | | | | |
| Device Operating Voltage (V_D) | | 8.5 | 8.75 | V | |
| Device Operating Current (I_D) | | 147 | 168 | mA | Quiescent, $V_D=8.5V$ |
| Thermal Resistance (R_{TH}) | | 49 | | $^\circ C/W$ | Junction-to-Pin4, at Quiescent current, $V_D=8.5V$ |

Performance Downstream Application Circuit $V_{CC} = 8.5V$, $I_{CC} = 147mA$

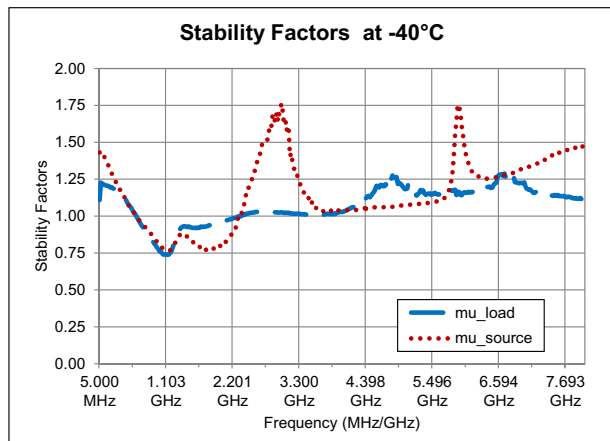
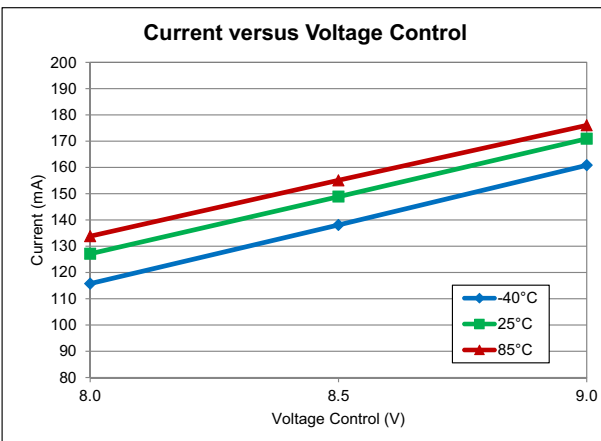
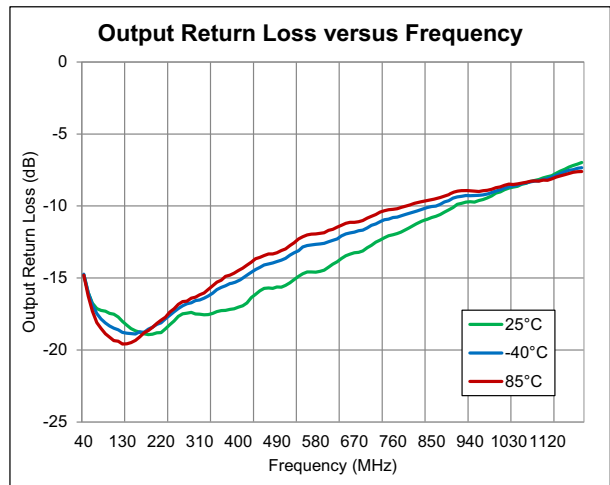
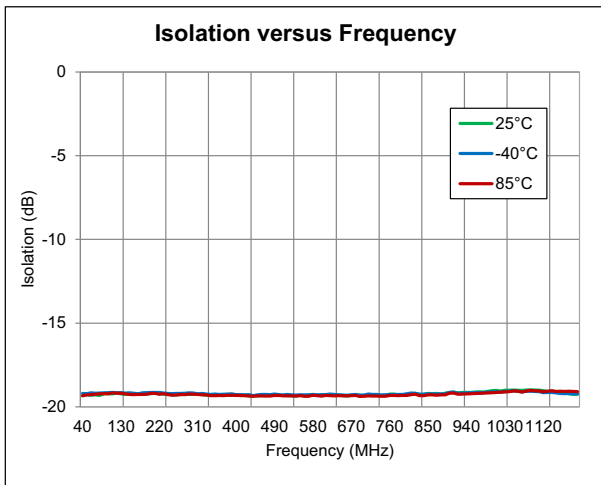
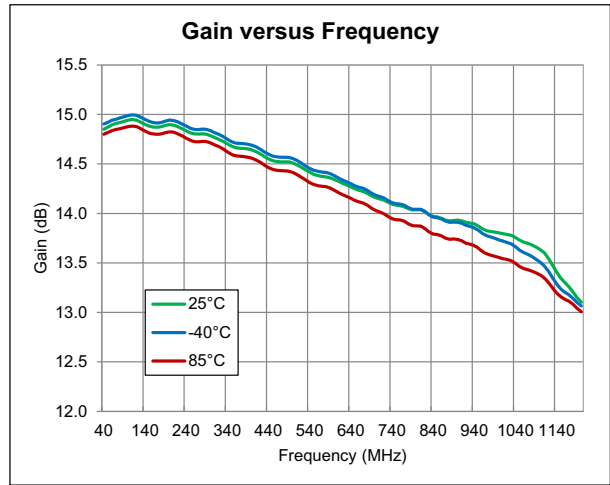
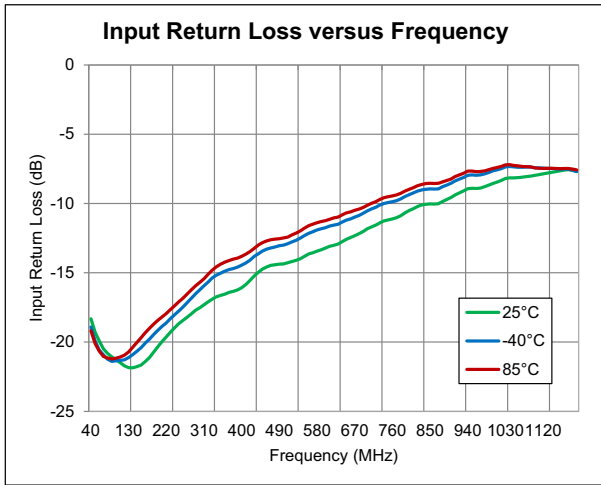

Performance Downstream Application Circuit $V_{CC} = 8.5V$, $I_{CC} = 147mA$

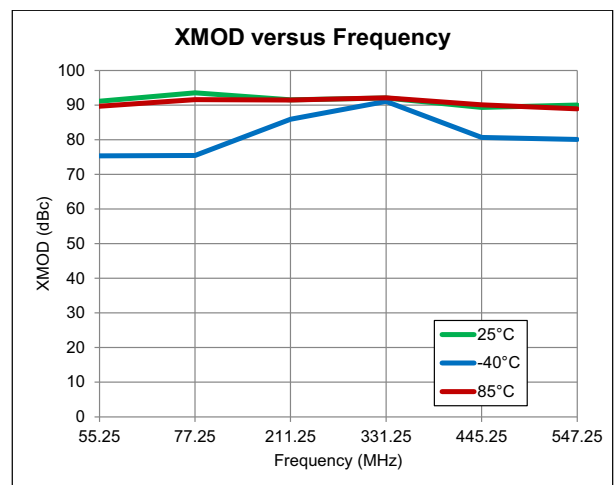
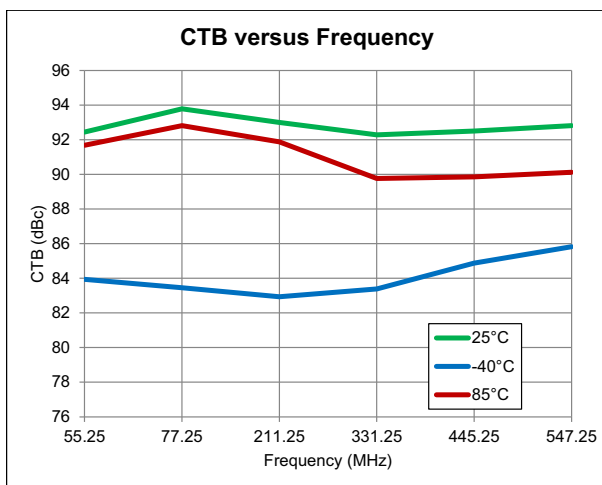
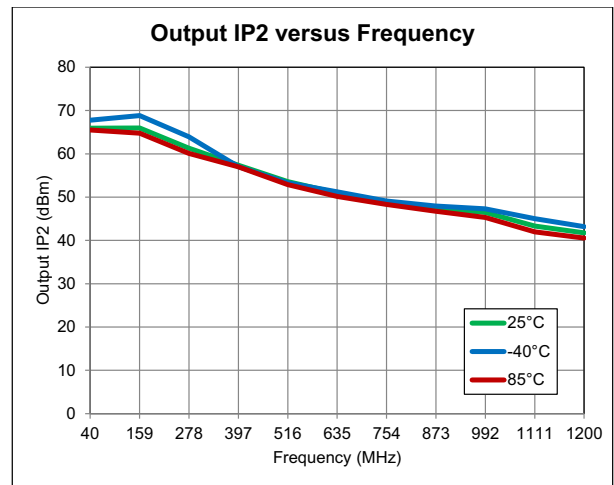
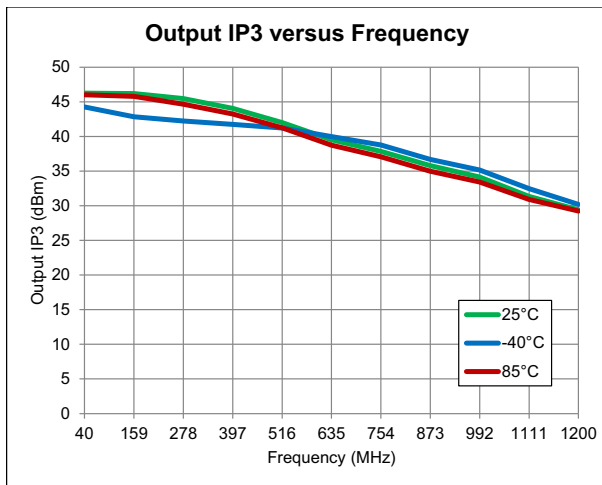
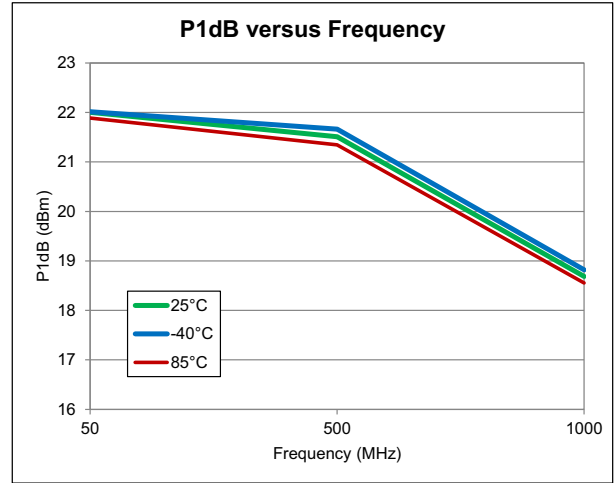
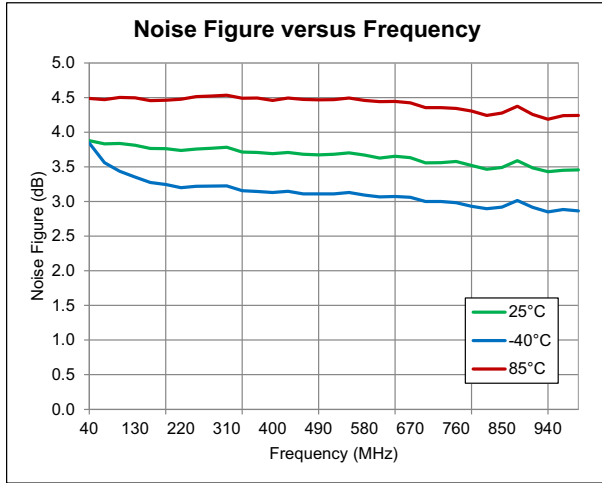

Performance Downstream Application Circuit $V_{CC} = 8.5V$, $I_{CC} = 147mA$

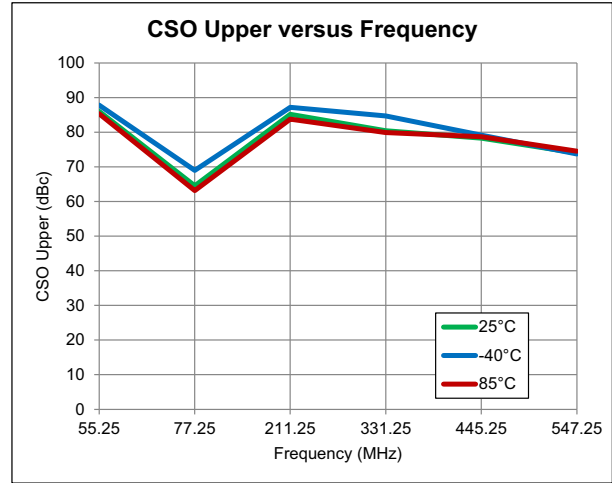
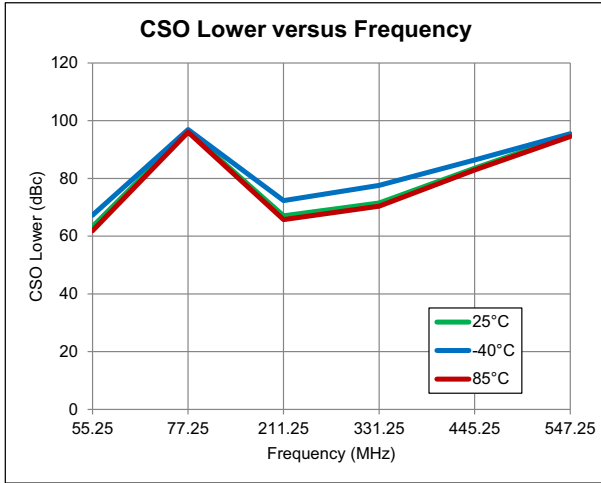

Performance Upstream Application Circuit $V_{CC} = 8.5V$, $I_{CC} = 147mA$

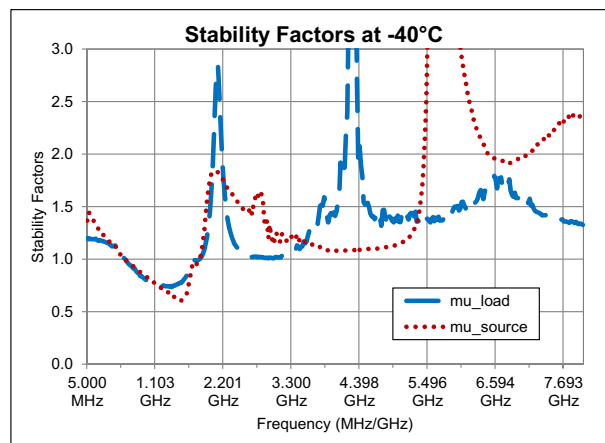
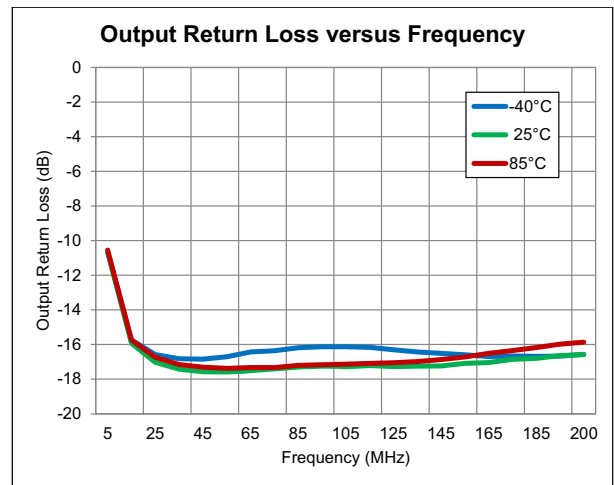
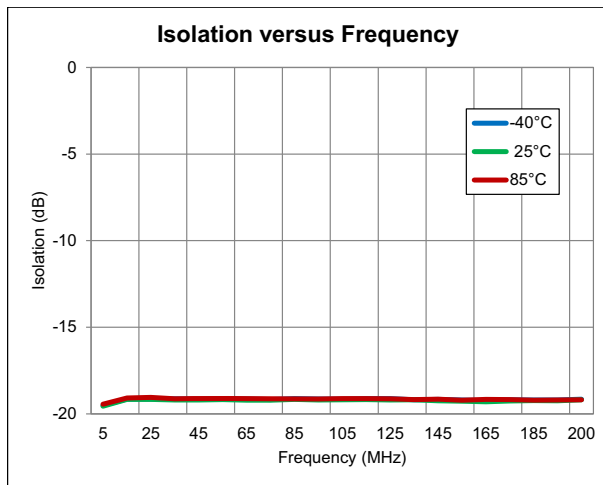
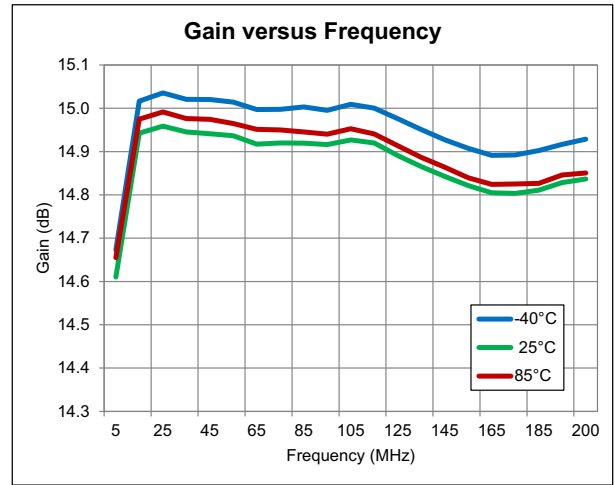
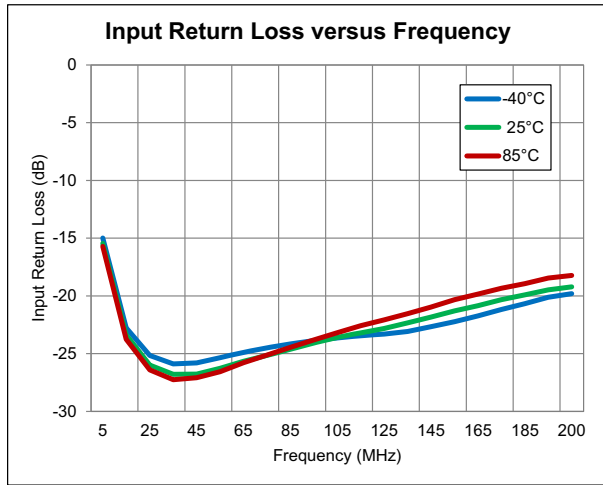

Performance Upstream Application Circuit $V_{CC} = 8.5V, I_{CC} = 147mA$

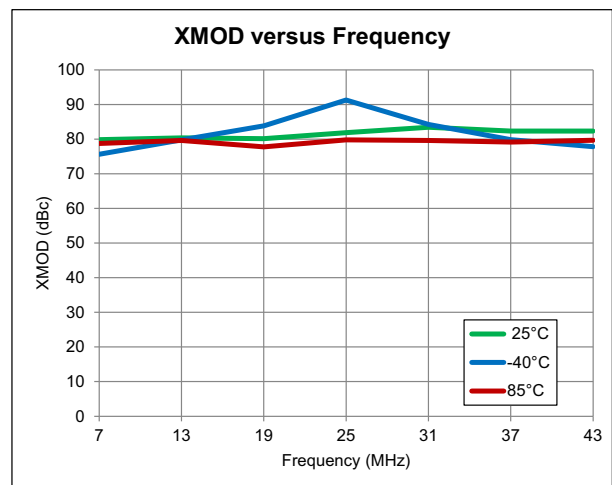
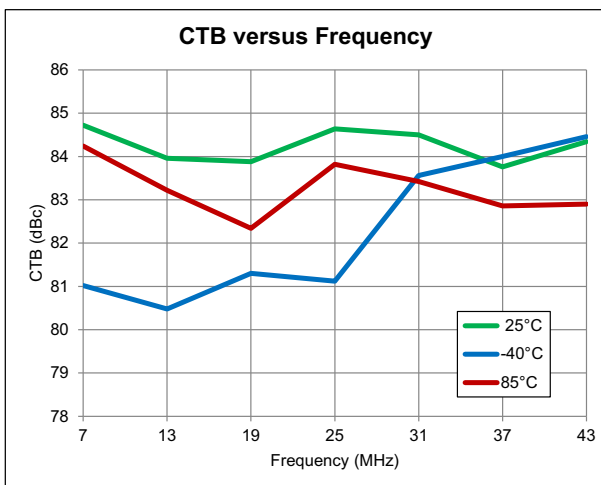
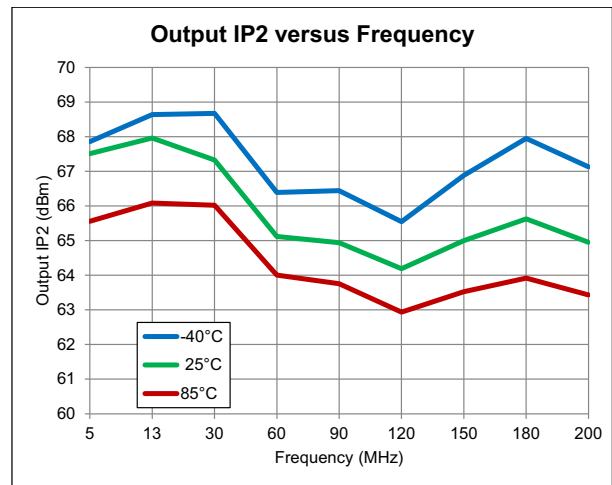
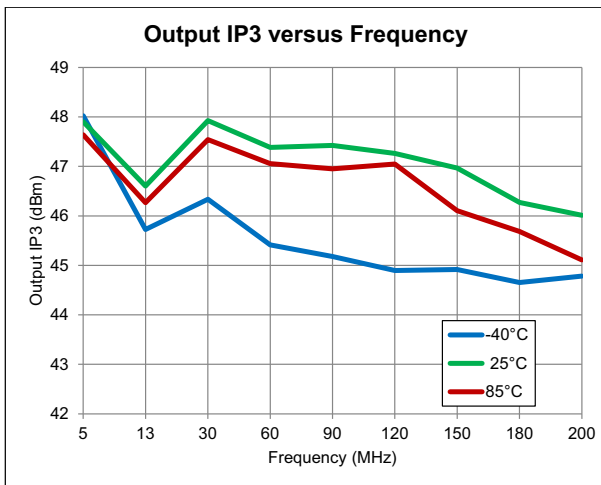
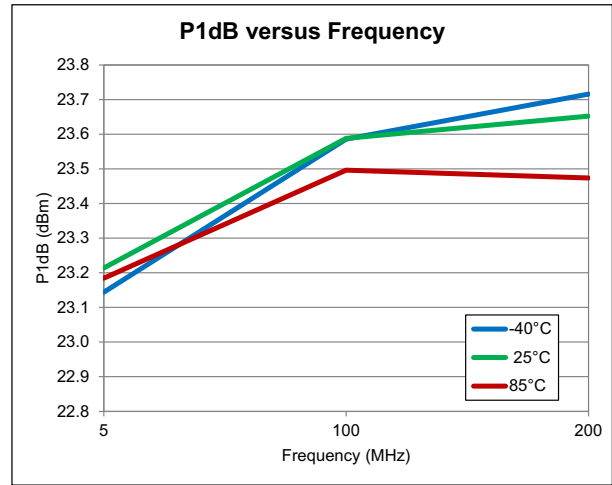
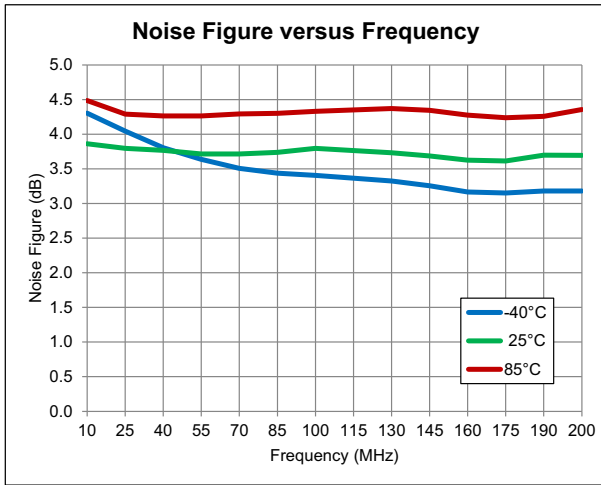

Performance Upstream Application Circuit $V_{CC} = 8.5V$, $I_{CC} = 147mA$

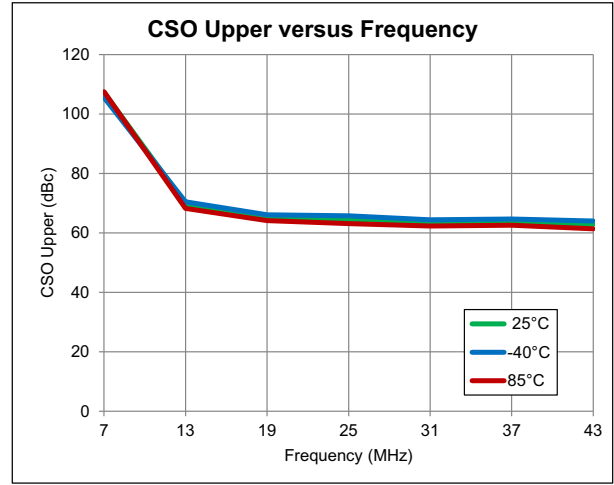
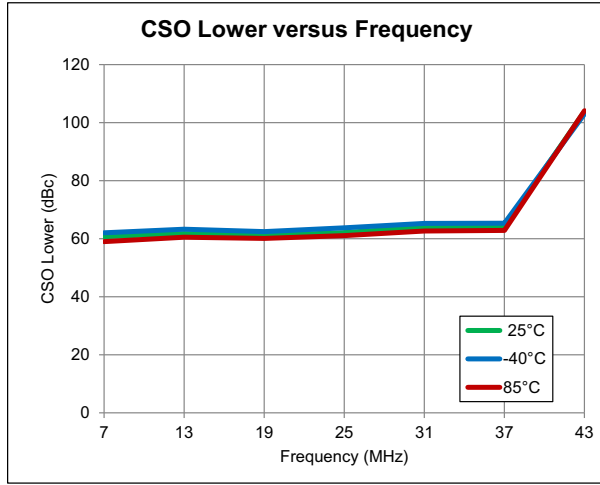

Evaluation Board Bill of Materials (BOM) Downstream Application Circuit (50MHz to 1000MHz)

| Description | Reference Designator | Manufacturer | Manufacturer's P/N |
|---|----------------------|------------------------------|--------------------|
| Evaluation Board | | | RFCA3310410(A) |
| CONN, HDR, ST, PLRZD, 2-PIN, 0.100" | P1 | ITW Panon | MPSS100-2-C |
| CONN, F FEM EDGE MOUNT, 75Ω, 0.068" | J1-J2 | Millimeter Wave Technologies | MW-846-C-DD-75 |
| IND, 1000nH, 5%, W/W, 0603 | L1 | Coilcraft | 0603LS-102XJLC |
| RES, 0Ω, 0402 | L2 | Kamaya, Inc | RMC1/16SJPTH |
| IND, 6.8nH, 5%, M/L, 0402 | L3 | Toko America, Inc. | LL1005-FH6N8J |
| CAP, 1μF, 10%, 16V, X7R, 1206 | C1 | Panasonic Industrial Co | ECJ-3YB1C105K |
| CAP, 10000pF, 10%, 25V, X7R, 0402 | C4-C5 | Murata Electronics | GRM155R71E103KA01D |
| 0.3pF, 0.1pF, 50, NPO, 0402, LF LEAD FREE | C6 | Murata Electronics | GRM1555C1HR30BZ01D |
| CAP, 0.5pF, +/-0.1pF, 50V, HI-Q, 0402 | C8 | Murata Electronics | GJM1555C1HR50BB01D |
| CAP, 1200pF, 10%, 25V, X7R, 0402 | C3 | Panasonic Industrial Co | ECJ-0EB1E122K |
| RES, 1Ω, 5%, 1/16W, 0402 | R1 | Kamaya, Inc | RMC1/16S-1R0JTH |
| General Purpose Amplifier | U1 | RFMD | RFCA3310 |

Downstream Evaluation Board Schematic

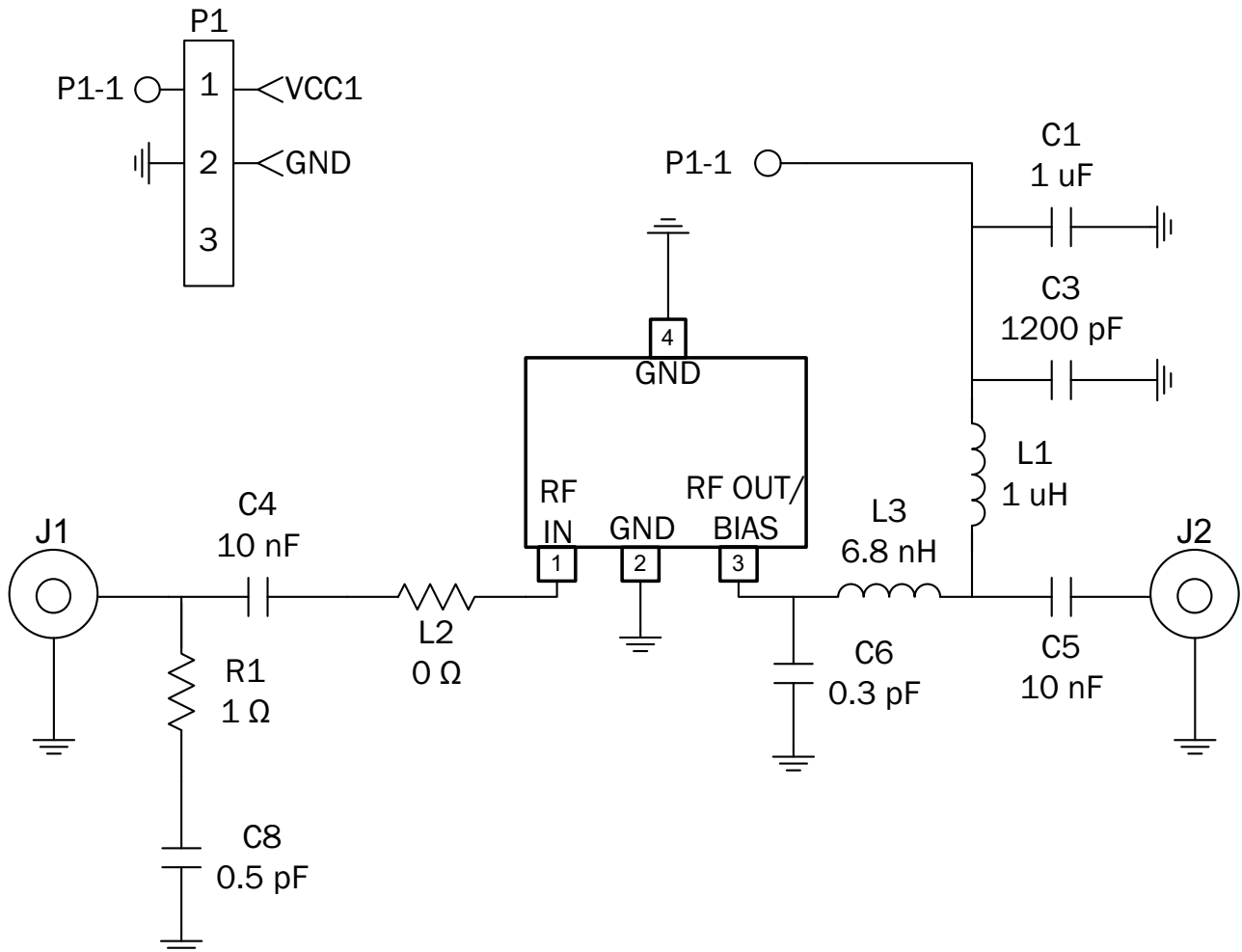

Evaluation Board Bill of Materials (BOM)

Upstream Application Circuit (5MHz to 200MHz)

| Description | Reference Designator | Manufacturer | Manufacturer's P/N |
|---|----------------------|------------------------------|--------------------|
| Evaluation Board | | | RFCA3310410(A) |
| CONN, HDR, ST, PLRZD, 2-PIN, 0.100" | P1 | ITW Panon | MPSS100-2-C |
| CONN, F FEM EDGE MOUNT, 75Ω, 0.068" | J1-J2 | Millimeter Wave Technologies | MW-846-C-DD-75 |
| IND, 3.9uH, 5%, 420mA, W/W, 1008 | L1 | Coilcraft | 1008LS-392XJLB |
| RES, 0Ω, 0402 | L2 | Kamaya, Inc | RMC1/16SJPTH |
| IND, 6.8nH, 5%, M/L, 0402 | L3 | Toko America, Inc. | LL1005-FH6N8J |
| CAP, 1μF, 10%, 16V, X7R, 1206 | C1 | Panasonic Industrial Co | ECJ-3YB1C105K |
| 0.3pF, 0.1pF, 50, NPO, 0402, LF LEAD FREE | C6 | Murata Electronics | GRM1555C1HR30BZ01D |
| CAP, 1pF, +/-0.1pF, 50V, COG, 0402 | C8 | Murata Electronics | GRM1555C1H1R0BZ01D |
| CAP, 15000pF, 10%, 16V, X7R, 0402 | C4-C5 | Murata Electronics | GRM155R71C153KA01E |
| CAP, 1200pF, 10%, 25V, X7R, 0402 | C3 | Panasonic Industrial Co | ECJ-0EB1E122K |
| RES, 1Ω, 5%, 1/16W, 0402 | R1 | Kamaya, Inc | RMC1/16S-1R0JTH |
| General Purpose Amplifier | U1 | RFMD | RFCA3310 |

Upstream Evaluation Board Schematic

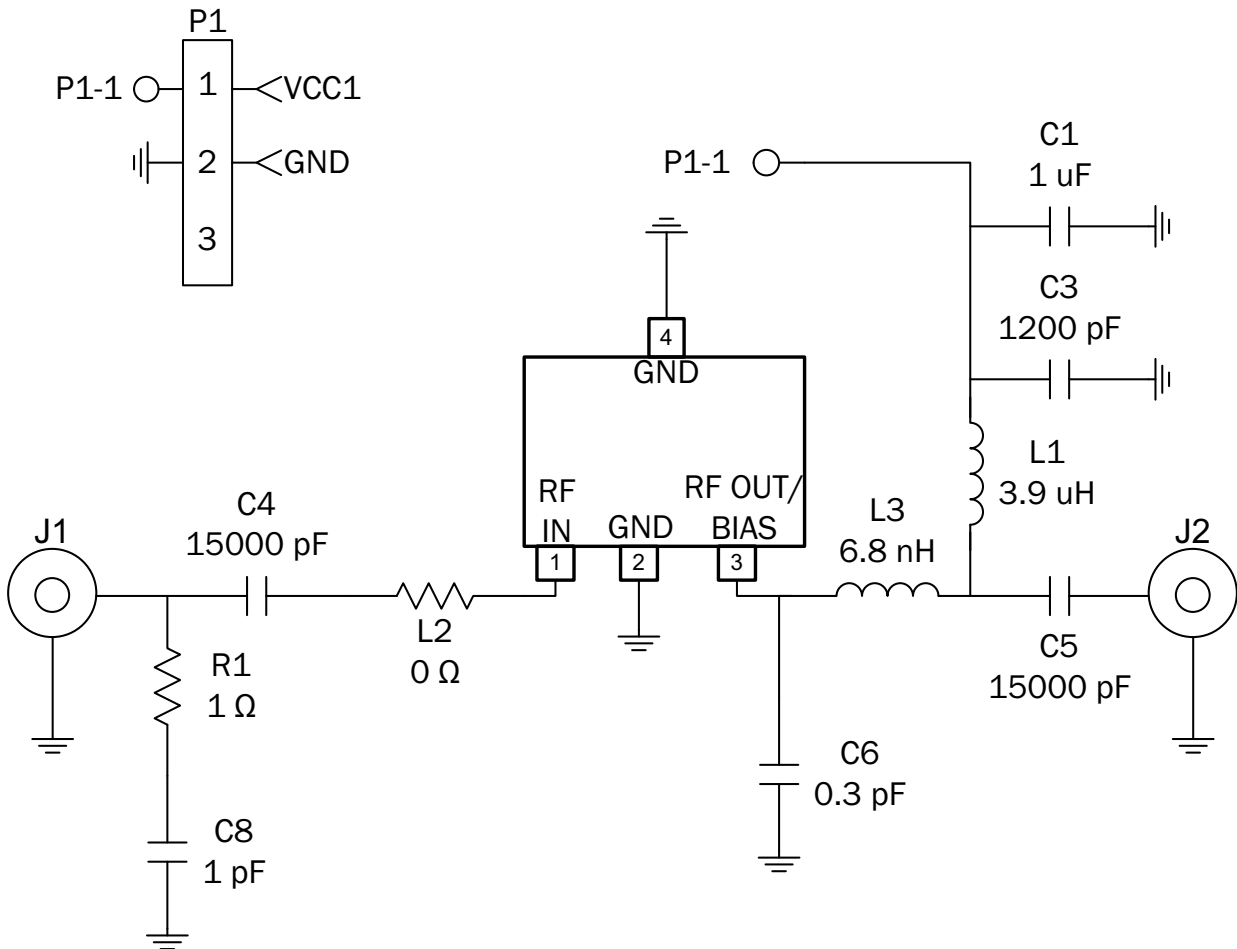

Pin Names and Descriptions

| Pin | Name | Description |
|-----|--------------|---|
| 1 | RF IN | RF Input, External DC-blocking Capacitor is Required |
| 2 | GND | DC and RF Ground |
| 3 | RF OUT / VCC | RF Output, Device Collector |
| 4 | GND | DC and RF Ground. Must be soldered to EVB ground plane over a bed of vias for thermal and RF performance. |

Evaluation Board Assembly Drawing

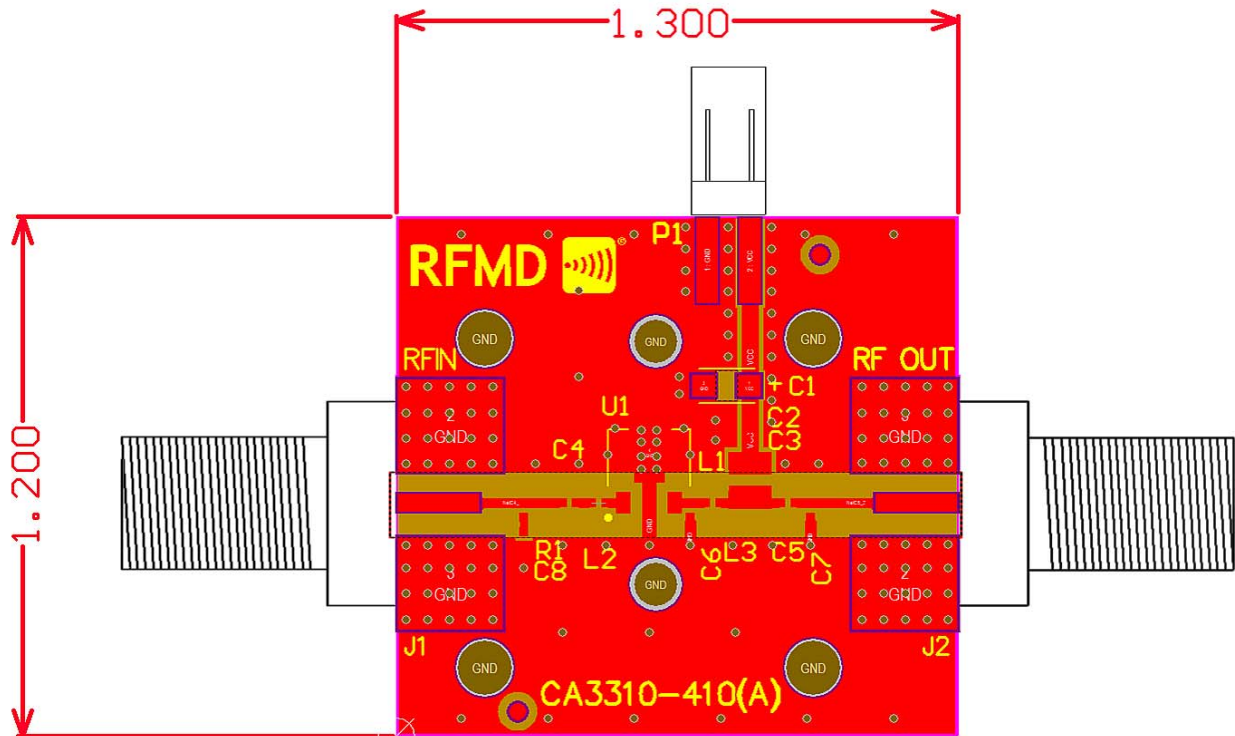

Package Drawing
Dimensions in Inches [Millimeters]

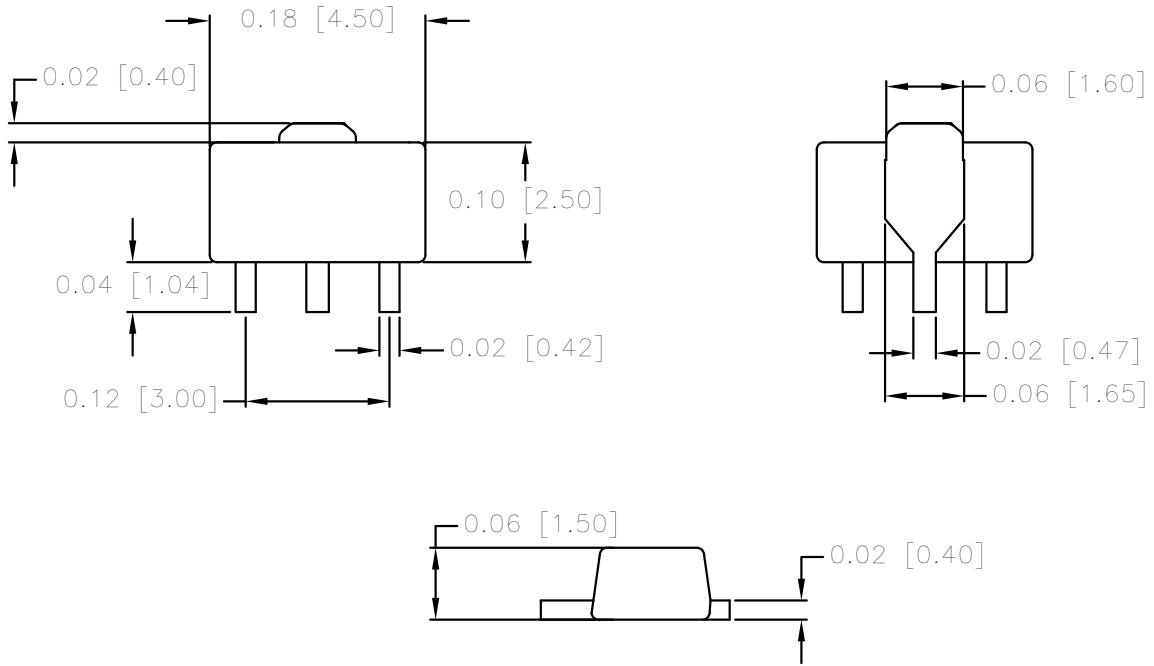

Branding Diagram

