

Wide Open Capability For Wide Open Spaces

Proof that bigger and better go hand in hand: Evolution Series 10" Poke-Thru Devices offer more capacity, flexibility and versatility than any other poke-thru device on the market. In offices, hospitals, government buildings, schools and universities – in all of the spaces where we live and work – clients are demanding more: more communications, more A/V and more power.

Featuring eight-gangs of capacity, redesigned and easier to use covers, recessed connections below floor level, and enough internal wiring capacity to eliminate the need for a junction box – Evolution Series 10" Poke-Thru Devices are ready to meet that increased demand.

The Evolution™ Series 10" Poke-Thru Device features up to eight-gangs of capacity and is the largest capacity poke-thru device available.

Features & Benefits

- **Largest capacity poke-thru devices on the market.** The 10AT Series is designed for a 10" (254mm) core hole and provides up to eight (8) gangs of power, communication, and/or A/V capability.
- **Internal wiring capacity.** Evolution Series 10" Poke-Thru Devices are the first in the industry with the capacity to accommodate wiring connections inside the unit, eliminating the need for an external junction box and making future moves, adds and changes faster and easier.
- **Recessed devices.** All power, communication, and A/V devices are recessed below floor level, providing maximum protection and device longevity.
- **"Step-on-it" installation.** Quick and easy installation without the need for additional fasteners or a second installer.
- **Die-cast aluminum cover assemblies.** All metal die-cast aluminum cover assemblies, with two spring-loaded slide egress doors.
- **Auto-close sliding egress doors.** Egress doors lock in position when open and automatically close around cables, reducing the egress opening to the smallest size possible.
- **Stronger hinge.** New design features an improved, stronger hinge with a more fluid opening and closing motion.
- **Multiple color options.** Offered in six different colors: black, gray, brass, nickel, bronze and aluminum.
- **TopGuard Protection.** All Evolution Series Poke-Thru Devices meet and exceed UL scrub water exclusion requirements for tile, carpet, and wood covered floors.
- **Meets ADA Accessibility Guidelines.** Trim flange is designed to meet the ADA Accessibility Guidelines as it pertains to ADA Standard 4.5 which addresses changes in floor and ground surface levels. The poke-thru trim flanges are beveled so the slope is no greater than 1:2 ratio.
- **Suitable for use in air handling spaces.** In accordance with Section 300-22(C) of the National Electrical Code.
- **UL Listed and UL Fire Classified to U.S. and Canadian safety standards.** UL Fire rated for up to 2-hour rated floors maintains the fire classification of the floor.

Vertical Markets

- Hospitality
- Entertainment
- Healthcare



Compliance

- **cULus Listed Metallic Outlet Boxes:** File E2961 Guide QCIT
- **cULus Listed Nonmetallic Outlet Boxes and Fittings Classified for Fire Resistance:** File R8209 Guide CEYY
- **Meets Article 300.21, 300.21(C) & 314 of NEC**



Protection from water,
dirt, and debris.

Evolution Series 10" Poke-Thru Device Cabling Specifications

Copper Cross Section:

The copper cross-sectional area determines the amount of wire fill capacity in a poke-thru device. Unlike other wire and cable management systems that utilize wire fill capacity, a poke-thru device is UL tested under fire conditions to determine the maximum amount of copper conductors that will pass through a poke-thru device, while maintaining the fire-rating of the floor assembly. All Legrand Poke-Thru Devices are UL Classified to U.S. and Canadian safety standards.

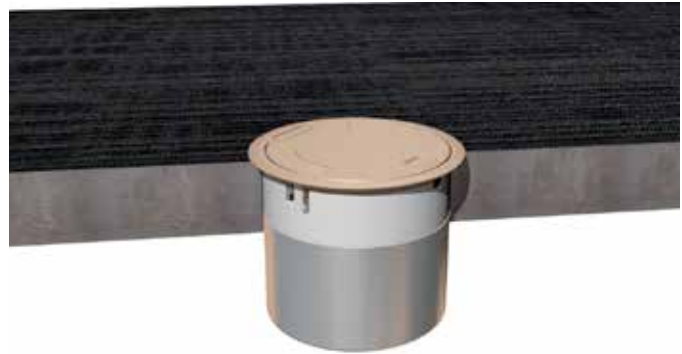

10AT COPPER CROSS-SECTION

	OUTER CHANNELS	CENTER CHANNEL
Max Copper X-Section	0.0288 sq. in. (18.58mm ²)	0.0960 sq. in. (61.94 mm ²)
Max # Conductors	(5) 12 AWG	(29) 14 AWG

NOTE: When using conductor sizes other than listed above, the aggregate cross-sectional area of the copper conductors shall not exceed the cross-sectional areas listed.

Copper Cross Sectional Area of Commonly Used Conductors		
Size	Solid	
#24	.00032 sq. in.	(.206mm ²)
#23	.00040 sq. in.	(.258mm ²)
#22	.00050 sq. in.	(.322mm ²)
#14	.00323 sq. in.	(2.083mm ²)
#12	.00512 sq. in.	(3.303mm ²)
#10	.00815 sq. in.	(5.258mm ²)
# 8	.01296 sq. in.	(8.361mm ²)

NOTE: Use above values for solid or stranded conductors.

Evolution Series 10" Poke-Thru Device Flooring Specifications

10AT CORE HOLE SIZES

FLOOR TYPE	CORE SIZE (Min.)	CORE SIZE (Max.)
Covered Floors (Carpet, Tile or Wood)	10" (254mm)	10 1/8" (257mm)
Bare Concrete or Terrazzo	10" (254mm)	10 1/8" (257mm)

CAUTION: These devices are suitable for 1-, 1 1/2-, and 2-hour rated floor assemblies as described in the UL Fire Resistance directory for each service. These devices meet all UL scrub water requirements, but are not suitable for wet or damp locations, or other areas subject to saturation with water or other liquids, such as commercial kitchens.

Floor Coverings: The poke-thru device is fire rated for concrete floor coverings. For floor coverings greater than 1" (25mm), consult factory.

UL Certification: To view the UL certification, please visit www.UL.com/Database. Enter "Wiremold" as the company name and "CEYY" as the UL Category Code.

Poke-thru devices and abandonment fittings are for use with 1-, 1 1/2-, or 2-hour rated unprotected reinforced concrete floor and 1-, 1 1/2- or 2-hour rated floors employing unprotected steel floor units and concrete topping (D900-Series Designs), or concrete floors with suspended ceilings. (Fire resistive designs with suspended ceilings should have provisions for accessibility in the ceiling area below the poke-thru fittings).

The assembled Poke-Thru stem and service fitting or the abandonment fittings will not reduce the ratings of the floor assembly when the thickness and type of concrete (required for the specific rating) are within the specified limits and the fittings are installed as specified:

- Spacing** – Minimum of 2' (610mm) OC and not more than one unit per 65 square feet (6 square meters) of floor area in each span.
- Concrete** – Minimum thickness of structural concrete topping of 2 1/4" (57mm) over metal deck or a minimum 3" thick reinforced concrete slab. Unit weight of concrete to be 110 to 155 pcf.
- Installation** – Mounted in a 10" (254mm) diameter core drilled hole in concrete per installation instructions accompanying the fittings or abandonment fittings. For use with power circuits, data and/or telephone cables as tabulated below.

NOTE: The material that is used in Wiremold® poke-thru devices is not listed under the directory for Fire Stopping Material because the poke-thru device is UL Classified as "Outlet Boxes and Fittings Classified For Fire Resistance (CEYY)". The pass/fail criteria comes from UL263. The pass criteria is that the poke-thru unit cannot exceed 325° F. above ambient before the concrete slab (or deck) reaches this same temperature. Some poke-thru devices are tested for 2 hours while others are tested for 4 hours. The intumescent material has never been tested as a fire-stopping material as a stand-alone device. This material is designed to work as a unit with the entire poke-thru device.

Evolution Series 10" Poke-Thru Device Ordering Information

Catalog No./Item	Description/Specifications
10ATCPBK 10ATCPGY 10ATCPBS 10ATCPNK 10ATCPBZ 10ATCPAL	Recessed Prewired Assembly With Surface Style Cover – For use with 10" (254mm) diameter hole. Cover and stem are pre-assembled together. All devices are recessed 4 1/2" (114mm) below the finished floor level. Unit ships complete with an all aluminum cover (assembled) designed to sit on top of finished floor surface (carpet, tile, wood, concrete or terrazzo). Covers are available in the following powder coated finishes: black (BK), gray (GY), nickel (NK), brass (BS) and aluminum (AL).

Country of Origin: USA

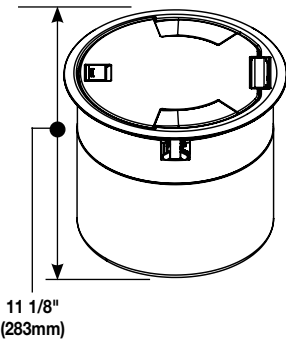

NOTE: UL Fire Classified for up to 2-hour rated floors.
NOTE: Receptacles can be wired as a standard or isolated ground device.

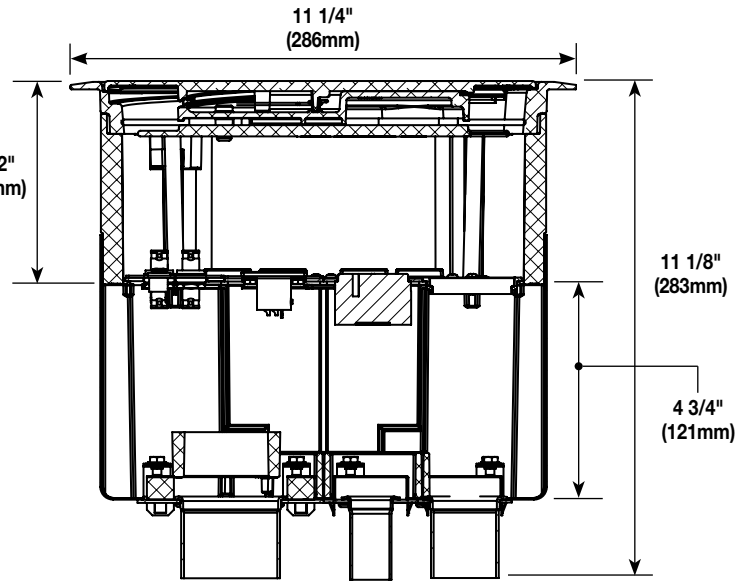
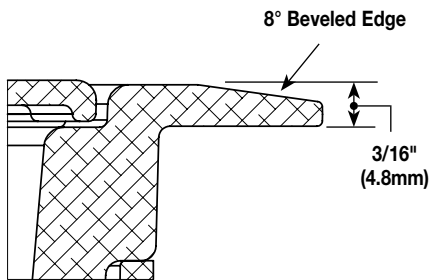

Includes two (2) proprietary 20A duplex receptacles

INSIDE VIEW

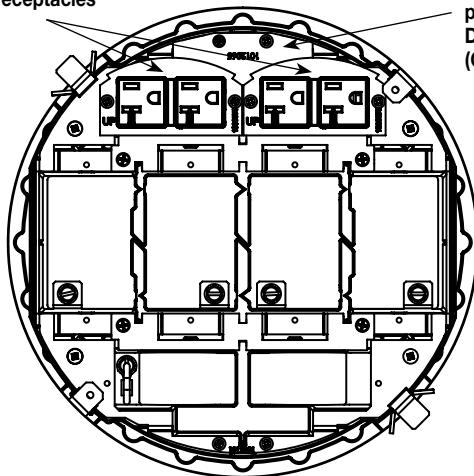

Includes two (2) proprietary 68DB Device Brackets (Only one shown)

Includes two (2) 10PTHA Outer Pass-Through Plates

Includes four (4) 1PTHA Center Pass-Through Plates

Includes one 10BLH Outer Blank Plate

Includes one 1075CHA Service Feed Plate

BOTTOM VIEW

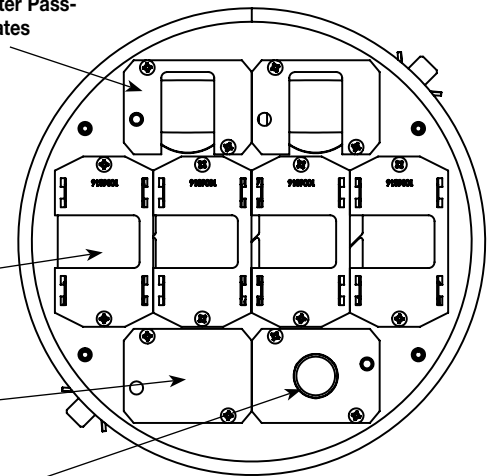

NOTE: For more information on Device Plates and Bottom Feed Plates and on the additional options available, see the Device Plates and Bottom Feed Plates sections found later in this document.

For more information or to configure your own Evolution™ Series Poke-Thru Device, visit our online configurator at: www.legrand.us/evolution.

Evolution Series 10" Poke-Thru Device Ordering Information

Catalog No./Item

Description/Specifications

10ATCBK
10ATCGY
10ATCBS
10ATCNK
10ATCBZ
10ATCAL

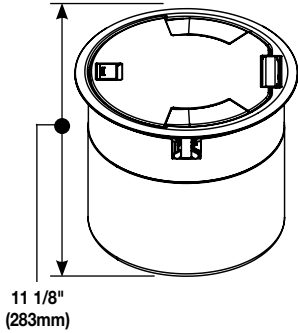

Recessed Unwired Assembly With Surface Style Cover – For use with 10" (254mm) diameter hole. All devices are recessed 4 1/2" (114mm) below the finished floor level. Unit ships complete with an all aluminum cover (assembled) designed to sit on top of finished floor surface (carpet, tile, wood, concrete or terrazzo). Covers are available in the following powder coated finishes: black (BK), gray (GY), nickel (NK), brass (BS) and aluminum (AL).

Country of Origin: USA

NOTE: UL Fire Classified for up to 2-hour rated floors.

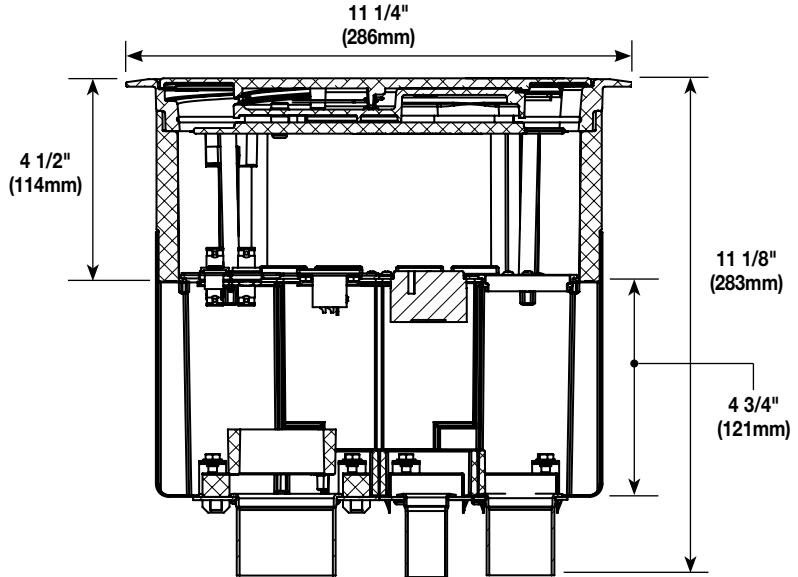
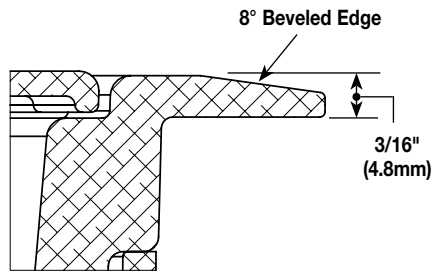

INSIDE VIEW

BOTTOM VIEW

Includes two (2) proprietary 68DB Device Brackets (Not shown)

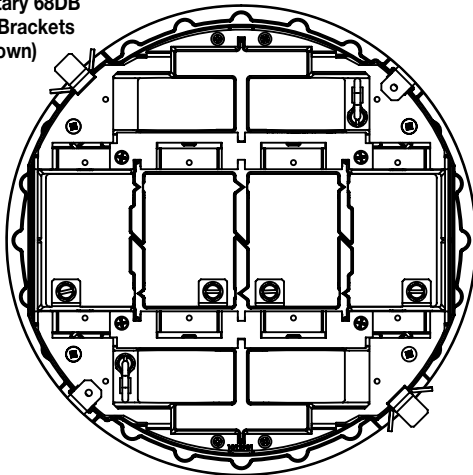

Includes two (2) 10PTHA Outer Pass-Through Plates

Includes four (4) 1PTHA Center Pass-Through Plates

Includes one 10BLH Outer Blank Plate

Includes one 1075CHA Service Feed Plate

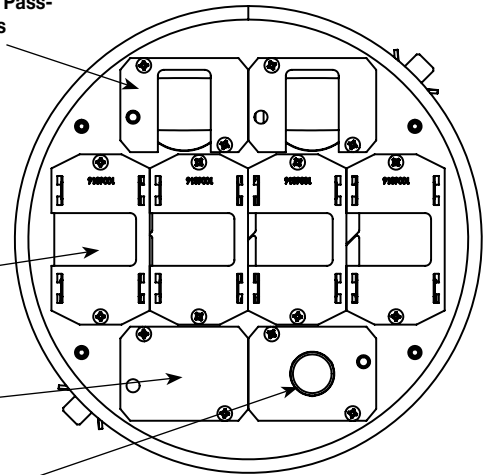

NOTE: For more information on Device Plates and Bottom Feed Plates and on the additional options available, see the Device Plates and Bottom Feed Plates sections found later in this document.

For more information or to configure your own Evolution™ Series Poke-Thru Device, visit our online configurator at: www.legrand.us/evolution.

Evolution Series 10" Poke-Thru Device Ordering Information

Catalog No./Item	Description/Specifications
------------------	----------------------------

10STC

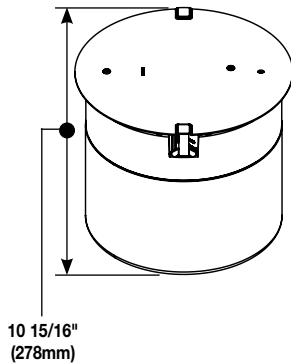

NOTE: UL Fire Classified for up to 2-hour rated floors.

Recessed Unwired Stem Assembly with Disposable Plate – For use with 10" (254mm) diameter hole. All devices are recessed 4 1/2" (114mm) below the finished floor level. Unit ships complete with a disposable construction cover. Unit works with 10" Evolution cover assemblies (10CTC). All cover assemblies are sold separately and are available in the following finishes: black (BK), gray (GY), nickel (NK), brass (BS) and aluminum (AL).

Country of Origin: USA

NOTE: Cover assemblies sold separately.

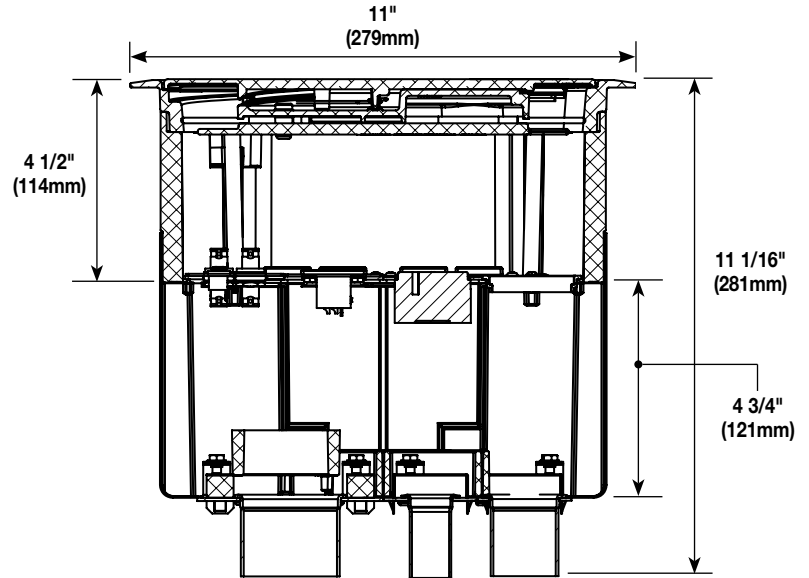

INSIDE VIEW

Includes two (2) proprietary 68DB Device Brackets (Not shown)

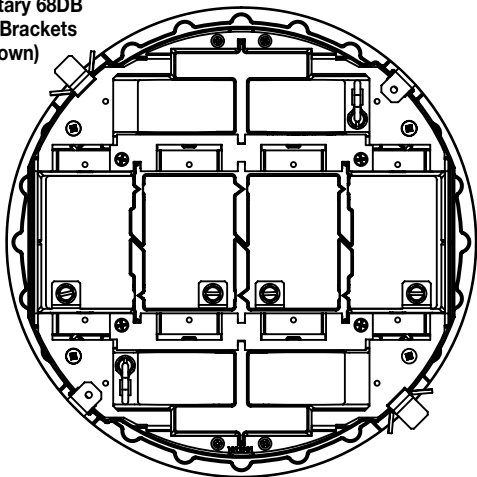

BOTTOM VIEW

Includes two (2) 10PTHA Outer Pass-Through Plates

Includes four (4) 1PTHA Center Pass-Through Plates

Includes one 10BLH Outer Blank Plate

Includes one 1075CHA Service Feed Plate

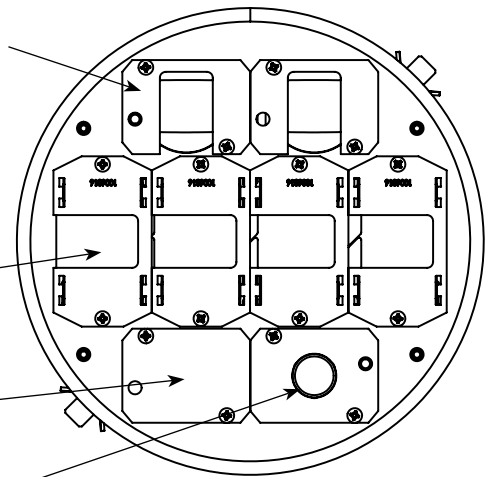

NOTE: For more information on Device Plates and Bottom Feed Plates and on the additional options available, see the Device Plates and Bottom Feed Plates sections found later in this document.

For more information or to configure your own Evolution™ Series Poke-Thru Device, visit our online configurator at: www.legrand.us/evolution.

Evolution Series 10" Poke-Thru Device Ordering Information

Catalog No./Item

Description/Specifications

10STCP

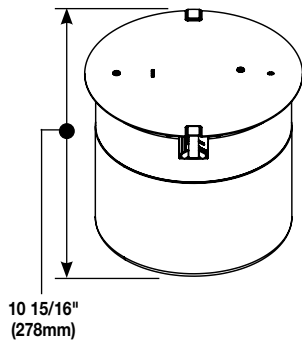

Recessed Stem Assembly with Disposable Plate – For use with 10" (254mm) diameter hole. All devices are recessed 4 1/2" (114mm) below the finished floor level. Unit ships complete with a disposable construction cover. Unit works with 10" Evolution cover assemblies (10CTC). All cover assemblies are sold separately and are available in the following finishes: black (BK), gray (GY), nickel (NK), brass (BS) and aluminum (AL).

Country of Origin: USA

NOTE: Cover assemblies sold separately.

NOTE: UL Fire Classified for up to 2-hour rated floors.

NOTE: Receptacles can be wired as a standard or isolated ground device.

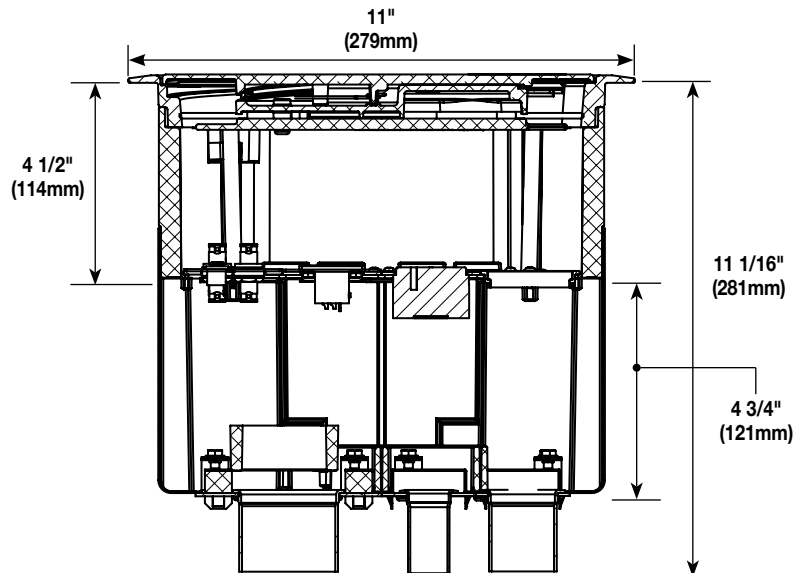

INSIDE VIEW

Includes two (2) proprietary 20A duplex receptacles

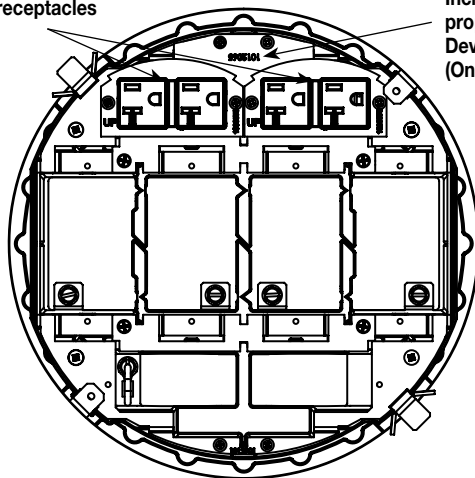

Includes two (2) proprietary 68DB Device Brackets (Only one shown)

BOTTOM VIEW

Includes two (2) 10PTHA Outer Pass-Through Plates

Includes four (4) 1PTHA Center Pass-Through Plates

Includes one 10BLH Outer Blank Plate

Includes one 1075CHA Service Feed Plate

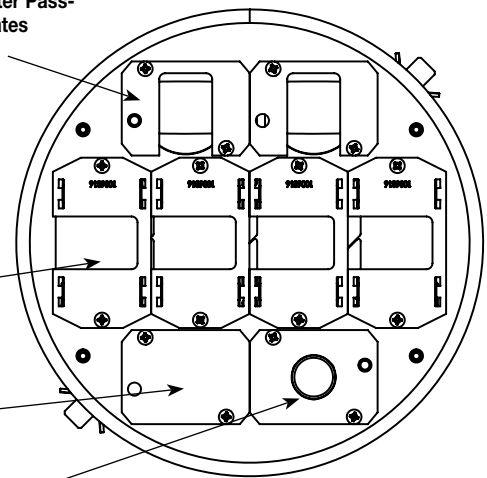

NOTE: For more information on Device Plates and Bottom Feed Plates and on the additional options available, see the Device Plates and Bottom Feed Plates sections found later in this document.

For more information or to configure your own Evolution™ Series Poke-Thru Device, visit our online configurator at: www.legrand.us/evolution.

Evolution Series 10" Poke-Thru Devices Cover Assemblies Ordering Information

10CTCGY*
10CTCBK*
10CTCBS*
10CTCBZ*
10CTCNK*
10CTCAL*

Surface Style Cover Assembly – Die-cast aluminum cover assembly. Cover assembly is available in the following powder coat finishes: black (BK), gray (GY), nickel (NK), brass (BS), bronze (BZ) and aluminum (AL). 10CTC Series Cover Assemblies designed for use with 10STC and 10STCP Poke-Thru Stem Assemblies.

Country of Origin: India

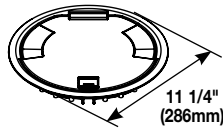

NOTE: All surface style poke-thru devices come with a transition angle to aid in the change in floor elevation.

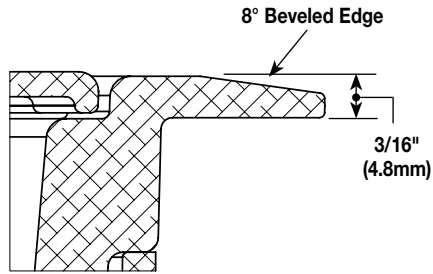

* Add suffix "TR" to the end of the part number to indicate tamper-resistant cover assembly. Tamper-resistant versions are secured with a single tamper-resistant screw.

10PPS

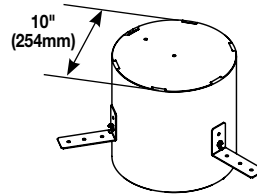

Pre-Pour Sleeve – Nonmetallic sleeve attaches to structural decking or plywood base and maintains a 10"-10 1/8" (254mm - 257mm) cast in hole. Includes three (3) attachment lugs, three (3) thumb screws and two (2) end caps.

Country of Origin: USA

ABPLUG10

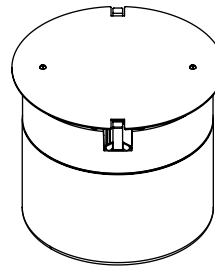

Abandonment Plug Assembly – Complete abandonment plug assembly for 10" opening. Assembly includes intumescent fire stop material to maintain a 2-hour fire rating of the floor.

Country of Origin: USA

Cover Assemblies for the Evolution™ Series 10AT Poke-Thru Devices are available in a variety of finishes and service configurations for carpet or tile floor installations.

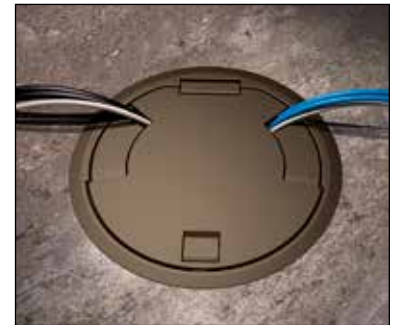

Evolution Series 10" Poke-Thru Devices Accessories Ordering Information

10DIV

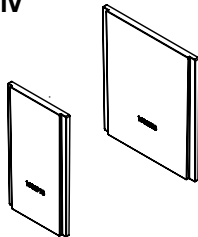

Replacement Divider – Used to separate services in the center and outer compartments. Includes one (1) center compartment and one (1) external compartment.

Country of Origin: USA

10TUN

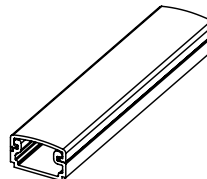

Tunnel – Tunnel allows for a single service to be fed from one external compartment across the opposite external compartment while maintaining service separation.

Country of Origin: USA

Evolution Series 10" Poke-Thru Devices Side Mount Device Plates Ordering Information

68REC*

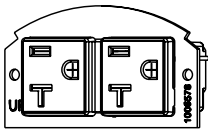

20AMP Duplex Receptacles – Two (2) proprietary 20AMP duplex power receptacles with mounting plates. Designed to fit in either of the two side compartments in the 6ATC, 8ATC and 10ATC Series Poke-Thru Devices. Receptacle can be wired as a standard or isolated ground device.

Country of Origin: USA

68REC-25*

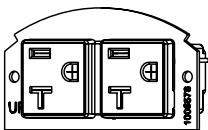

20Amp Duplex Receptacles – Two (2) proprietary 20AMP duplex power receptacles with mounting plates and 25' leads. Designed to fit in either of the two side compartments in the 6ATC, 8ATC and 10ATC Series Poke-Thru Devices. Receptacle can be wired as a standard or isolated ground device.

Country of Origin: USA

68DB

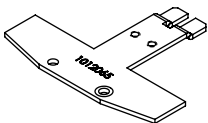

Replacement Device Bracket – Allows outer compartments to be adapted to accept any of the 68 device plates. One 68DB is required to mount two 68 device plates in each outer compartment.

Country of Origin: USA

NOTE: Each of the poke-thru assemblies includes two (2) 68DB Brackets.

682A*

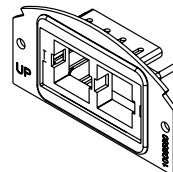

Device Mounting Plate – Device plate that will accept up to two (2) ports of communication devices. For use in either of the two side compartments only. Not for use in the center compartment. Communication devices supplied by others.

Country of Origin: USA

68B*

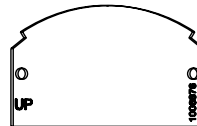

Device Mounting Plate – Blank plate. Used to blank off either of the side compartments when no devices or cabling are to be used.

Country of Origin: USA

68MAAP*

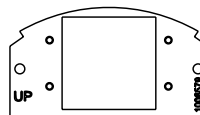

Device Mounting Plate – Device plate that will accept up to two (2) Legradn AVIP devices or Extron® Electronics MAAP device plates. For use in either of the two side compartments only. Not for use in the center compartment. Extron Devices supplied by others.

Country of Origin: USA

68REC-CTRL*

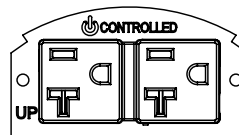

Controlled Receptacle – 20A proprietary duplex receptacle marked with controlled receptacle marking.

Country of Origin: USA

NOTE: Includes one receptacle.

Side Mount Device Plate Mounting Locations

Mounting plates on this page can be installed in the shaded location indicated in this illustration.

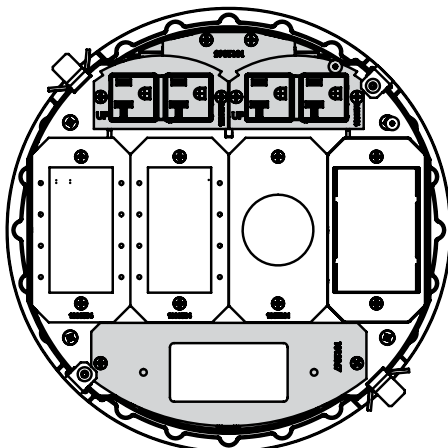

* 68DB mounting plate is required for all 68 device plates.

Evolution Series 10" Poke-Thru Devices Side Mount Device Plates Ordering Information

10DP



Device Mounting Plate – Single-gang device plate that accepts standard 20A duplex receptacle or a duplex Turnlok receptacle. Fits in any one (1) of the shaded locations shown. Devices supplied by others.

Country of Origin: USA

10DEC

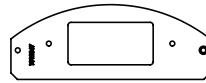

Device Mounting Plate – Single-gang device plate that will accept Decorator style devices such as 20A receptacles, GFCIs, 106 adapters or A/V devices. Fits in any one (1) of the shaded locations shown. Devices supplied by others.

Country of Origin: USA

10S1

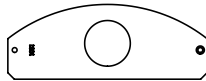

Device Plate – Receptacle opening 1 3/8" (35mm). Fits into any one (1) of the shaded areas shown.

Country of Origin: USA

10S2

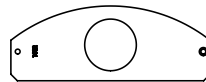

Device Plate – Receptacle opening 1 9/16" (40mm). Fits into any one (1) of the shaded areas shown.

Country of Origin: USA

10MAAP

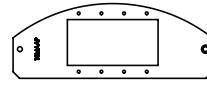

Device Mounting Plate – Single-gang device plate that will accept up to four (4) Legrand AVIP devices or Extron® Electronics MAAAP style plates. Fits into any one (1) of the shaded areas shown. Devices supplied by others.

Country of Origin: USA

10AAP

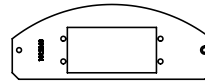

Device Mounting Plate – Two-gang device plate that will accept up to two (2) Extron® Electronics AAP style plates. Fits into any one (1) of the shaded areas shown. Devices supplied by others.

Country of Origin: USA

Side Mount Device Plate Mounting Locations

Mounting plates on this page can be installed in the shaded location indicated in this illustration.

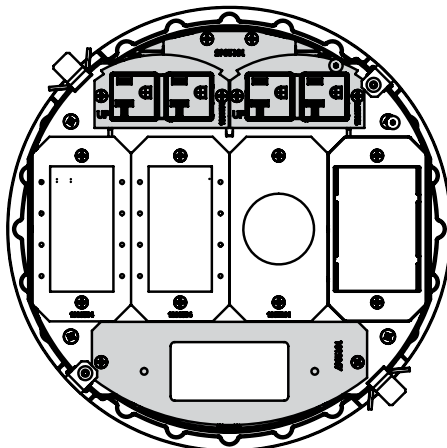

Evolution Series 10ATC Assembly with power, communication and A/V devices installed.

Evolution Series 10" Poke-Thru Devices Center Mount Device Plates Ordering Information

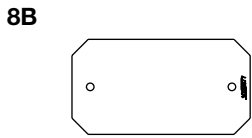

8B
Device Mounting Plate – Single-gang device plate used to blank off any one (1) of the four (4) gangs in the center compartment, when no devices are used.

Country of Origin: USA

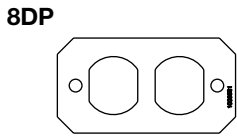

8DP
Device Mounting Plate – Single-gang device plate that accepts standard 20A duplex receptacle or a duplex Turnlok receptacle. Fits in any one (1) of the three four (4) in the center compartment. Devices supplied by others.

Country of Origin: USA

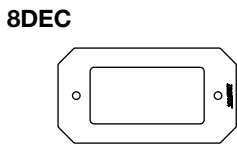

8DEC
Device Mounting Plate – Single-gang device plate that will accept Decorator style devices such as 20A receptacles, GFCIs, 106 adapters or A/V devices. Fits in any one (1) of the four (4) gangs in the center compartment. Devices supplied by others.

Country of Origin: USA

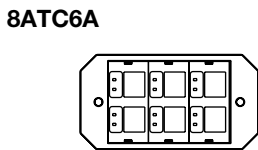

8ATC6A
Device Mounting Plate – Single-gang device plate that will accept up to six (6) ports of communication devices. Fits in any one (1) of the four (4) gangs in the center compartment. Devices supplied by others.

Country of Origin: USA

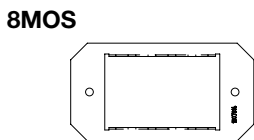

8MOS
Mosaic Device Plate – Device plate accepts three (3) standard Mosaic devices (45mm x 22.5mm). Devices supplied by others.

Country of Origin: USA

NOTE: Not designed to accept adorne™ devices.

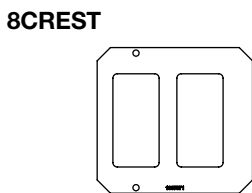

8CREST
Crestron® Double Gang Plate – Device plate accepts Crestron double-gang decorator style devices. Takes up two (2) of the four (4) center compartments.

Country of Origin: USA

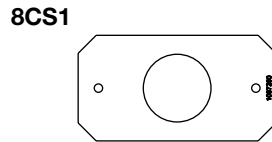

8CS1
Device Plate – Receptacle opening 1 3/8" (35mm). Fits in any one (1) of the four (4) gangs in the center compartment.

Country of Origin: USA

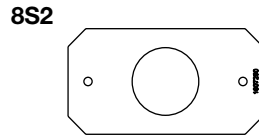

8S2
Device Plate – Receptacle opening 1 9/16" (40mm). Fits in any one (1) of the four (4) gangs in the center compartment.

Country of Origin: USA

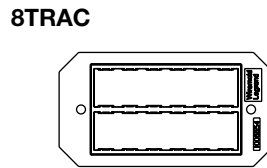

8TRAC
Device Mounting Plate – Single-gang device plate that will accept up to six (6) Ortronics TracJack devices. Fits in any one (1) of the four (4) gangs in the center compartment. Devices supplied by others.

Country of Origin: USA

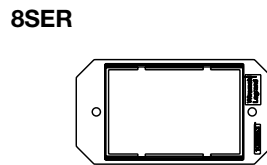

8SER
Device Mounting Plate – Single-gang device plate that will accept up to three (3) Ortronics Series II dual modular inserts. Fits in any one (1) of the four (4) gangs in the center compartment. Devices supplied by others.

Country of Origin: USA

Center Mount Device Plate Mounting Locations

Mounting plates on this page can be installed in the shaded location indicated in this illustration.

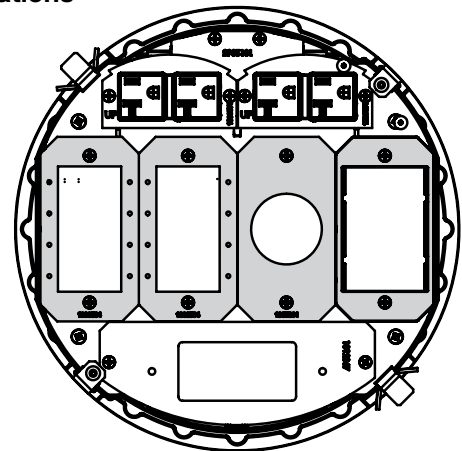

Evolution Series 10" Poke-Thru Devices Center Mount Device Plates Ordering Information

8MAAP

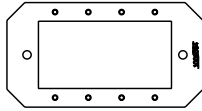

Device Mounting Plate – Single-gang device plate that will accept up to four (4) Legrand AVIP devices or Extron® Electronics MAAP style plates. Fits in any one (1) of the four (4) gangs in the center compartment. Devices supplied by others.

Country of Origin: USA

8AAP

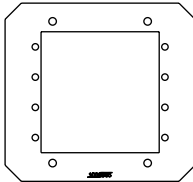

Device Mounting Plate – Two-gang device plate that will accept up to four (4) Extron® Electronics AAP style plates. 8AAP takes up 2 of the four (4) gangs in the center compartment. Devices supplied by others.

Country of Origin: USA

4GDEC

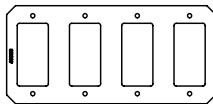

Device Mounting Plate – Accepts up to four (4) NEMA standard decorator style devices from most manufacturers.

Country of Origin: USA

4GB

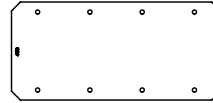

Device Mounting Plate – Blank plate. Used to blank off the entire center compartment when no devices or cabling are to be used.

Country of Origin: USA

4GDP

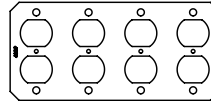

Device Mounting Plate – Accepts up to four (4) NEMA standard duplex style receptacles from most manufacturers.

Country of Origin: USA

8CREST3G

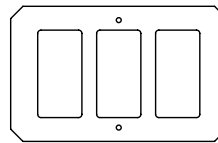

Crestron® Three-Gang Device Plate – Accepts a three-gang device including Crestron® Digital Media™ devices.

Country of Origin: USA

Center Mount Device Plate Mounting Locations

Mounting plates on this page can be installed in the shaded location indicated in this illustration.

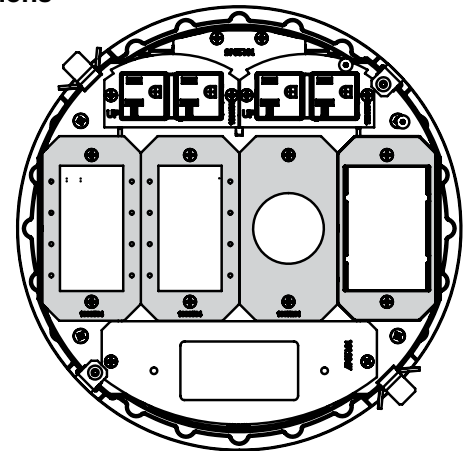

Evolution Series 10" Poke-Thru Devices Bottom Feed Assemblies Ordering Information

10BLH

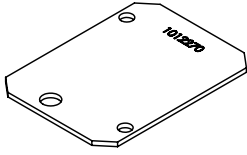

Bottom Housing Assembly – Exterior-gang blanking assembly. Designed to blank off one (1) of the four (4) exterior gang compartment locations.

Country of Origin: USA

10PTHA

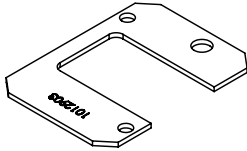

Bottom Housing Assembly – Exterior-gang pass through assembly. Designed to allow cables to pass through one (1) of the four (4) exterior-gang compartment locations.

Country of Origin: USA

1010CHA

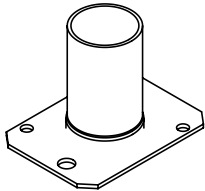

Bottom Housing Assembly – Exterior-gang 1" trade size conduit service feed assembly. Designed to allow connection to 1" trade size conduit feed in one (1) of the four (4) exterior-gang locations.

Country of Origin: USA

1075CHA

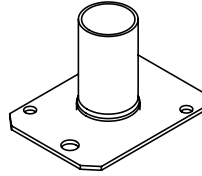

Bottom Housing Assembly – Exterior-gang 3/4" trade size conduit service feed assembly. Designed to allow connection to 3/4" trade size conduit feed in one (1) of the four (4) exterior-gang locations.

Country of Origin: USA

10125CHA

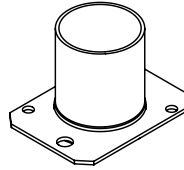

Bottom Housing Assembly – Exterior-gang 1 1/4" trade size conduit service feed assembly. Designed to allow connection to 1 1/4" trade size conduit feed in one (1) of the four (4) center-gang locations.

Country of Origin: USA

Bottom Feed Side Mount Device Plate Locations

All bottom housing assemblies on this page can be installed in the shaded locations indicated in these illustrations.

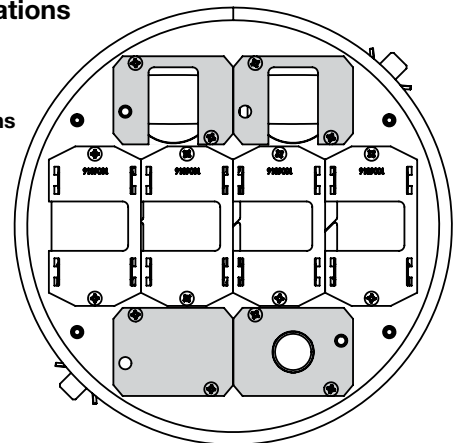

Evolution Series 10" Poke-Thru Devices Bottom Feed Assemblies Ordering Information

175CHA-LJB

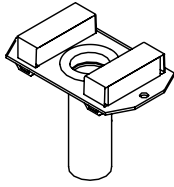

Bottom Housing Assembly –
One-gang 3/4" trade size conduit housing assembly. For use on any one of the four (4) gangs in the center compartments.

Country of Origin: USA

1125CHA

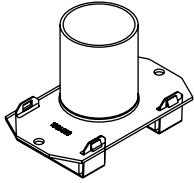

Bottom Housing Assembly –
One-gang 1 1/4" trade size conduit housing assembly. For use on any one (1) of the four (4) gangs in the center compartment.

Country of Origin: USA

1PTHA

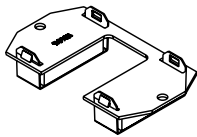

Bottom Housing Assembly –
One-gang pass through housing assembly. Designed to allow pass through of communication cables when no conduit is required. For use on any one (1) of the four (4) gangs in the center.

Country of Origin: USA

2210CHA

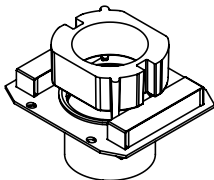

Bottom Housing Assembly –
Center-gang 2" trade size conduit service feed assembly. Designed to allow connection to 2" trade size conduit feed in two (2) of the four (4) center-gang locations.

Country of Origin: USA

NOTE: Bottom housing assembly comes with an intumescent sleeve. Sleeve must be assembled into the poke-thru unit to maintain fire classification.

2159CHA

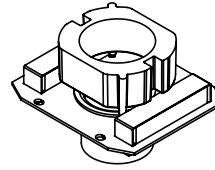

Bottom Housing Assembly –
Center-gang 1 1/2" trade size conduit service feed assembly. Designed to allow connection to 1 1/2" trade size conduit feed in two (2) of the four (4) center-gang locations.

Country of Origin: USA

NOTE: Bottom housing assembly comes with an intumescent sleeve. Sleeve must be assembled into the poke-thru unit to maintain fire classification.

1100CHA

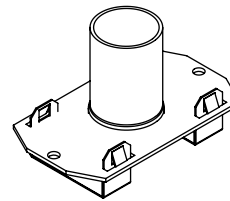

Bottom Housing Assembly –
One-gang 1" trade size conduit housing assembly. For use on any one of the four (4) gangs in the center compartments.

Country of Origin: USA

1BLH

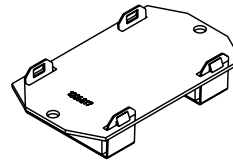

Bottom Housing Assembly –
One-gang blank housing assembly. Designed to blank off compartment when no cable pass through is required. For use on any one (1) of four (4) gangs in the center compartment.

Country of Origin: USA

Bottom Feed Center Mount Device Plate Locations

All bottom housing assemblies on this page can be installed in the shaded locations indicated in these illustrations.

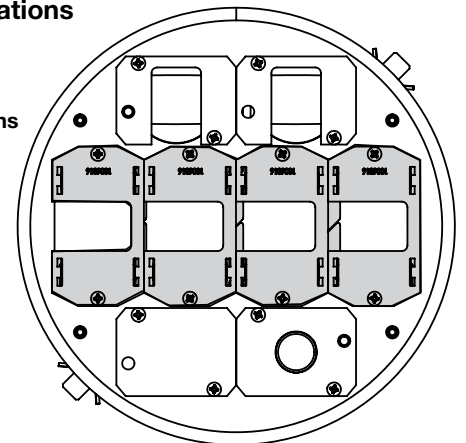

NOTE: All brand and product names referenced in this document are registered trademarks or trademarks of their respective holders.

 **NOTE:** The paper used to print this document is an environmentally responsible paper with 10% post consumer waste, with FSC and SFI Chain of Custody certifications, Lacey Act compliant. 100% of the electricity used to manufacture Flo sheets is generated with Green-e certified renewable energy.



Legrand, North America
60 Woodlawn Street
West Hartford, CT 06110
1.877.BY.LEGRAND (295.3472)
www.legrand.us

Canada
905.738.9195
www.legrand.ca

FOLLOW US

