

FEATURES

- 5 kV rms isolated RS-485/RS-422 transceiver
- ± 42 V ac/dc peak fault protection on RS-485 bus pins
- Certified Level 4 EMC protection on RS-485 A, B bus pins
 - IEC 61000-4-5 surge protection (± 4 kV)
 - IEC 61000-4-4 electrical fast transient (EFT) protection (± 2 kV)
 - IEC 61000-4-2 electrostatic discharge (ESD) protection
 - ± 8 kV contact discharge
 - ± 15 kV air discharge
 - IEC 61000-4-6 conducted radio frequency (RF) immunity (10 V/m rms)
- Certified IEC 61000-4-x immunity across isolation barrier
 - IEC 61000-4-2 ESD, IEC 61000-4-4 EFT, IEC 61000-4-5 surge, IEC 61000-4-6 conducted RF immunity, IEC 61000-4-3 radiated immunity, IEC 61000-4-8 magnetic immunity
- RS-485 A, B pins human body model (HBM) ESD protection: $> \pm 30$ kV
- Safety and regulatory approvals (pending)
 - CSA Component Acceptance Notice 5A, DIN V VDE V 0884-10, UL 1577, CQC11-471543-2012
- TIA/EIA RS-485/RS-422 compliant over full supply range
 - 3 V to 5.5 V operating voltage range on V_{DD2}
 - 1.7 V to 5.5 V operating voltage range on V_{DD1} logic supply
- Common-mode input range of -25 V to $+25$ V
- High common-mode transient immunity: > 75 kV/ μ s
- Robust noise immunity (tested to the IEC 62132-4 standard)
- Passes EN55022 Class B radiated emissions by 6 dB μ V/m margin
- Receiver short-circuit, open-circuit, and floating input fail-safe
- Supports 256 bus nodes (96 k Ω receiver input impedance)
- -40°C to $+125^\circ\text{C}$ temperature option
- Glitch free power-up/power-down (hot swap)

APPLICATIONS

- Heating, ventilation, and air conditioning (HVAC) networks
- Industrial field buses
- Building automation
- Utility networks

GENERAL DESCRIPTION

The [ADM2795E](#) is a 5 kV rms signal isolated RS-485 transceiver that features up to ± 42 V of ac/dc peak bus overvoltage fault protection on the RS-485 bus pins. The device integrates Analog Devices, Inc., *iCoupler*[®] technology to combine a 3-channel isolator, RS-485 transceiver, and IEC electromagnetic compatibility (EMC) transient protection in a single package. The [ADM2795E](#) is a RS-485/RS-422 transceiver that integrates IEC 61000-4-5 Level 4 surge protection, allowing up to ± 4 kV protection on the RS-485 bus pins (A and B). The device has IEC 61000-4-4 Level 4 EFT protection up to ± 2 kV and IEC 61000-4-2 Level 4 ESD protection on the bus pins, allowing this device to withstand up to ± 15 kV on the transceiver interface pins without latching up. This device has an extended common-mode input range of ± 25 V to improve data communication reliability in noisy environments. The [ADM2795E](#) is capable of operating over wide power supply ranges, with a 1.7 V to 5.5 V V_{DD1} power supply range, allowing interfacing to low voltage logic supplies. The [ADM2795E](#) is also fully TIA/EIA RS-485/RS-422 compliant when operated over a 3 V to 5.5 V V_{DD2} power supply. The device is fully characterized over an extended operating temperature range of -40°C to $+125^\circ\text{C}$, and is available in a 16-lead, wide-body SOIC package.

FUNCTIONAL BLOCK DIAGRAM

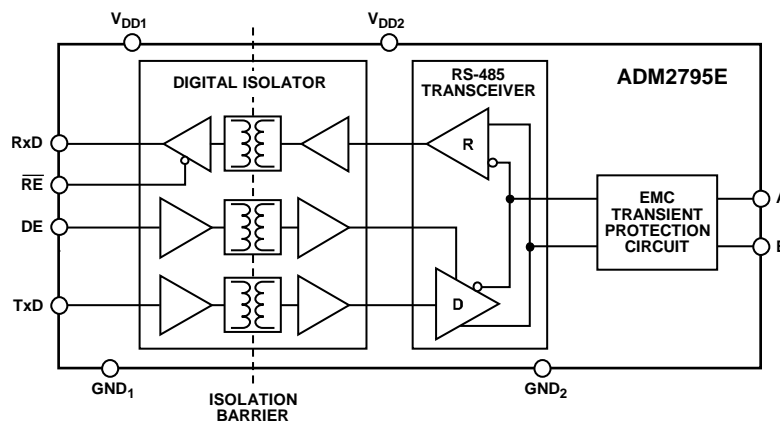

Figure 1.

Rev. B

[Document Feedback](#)

Information furnished by Analog Devices is believed to be accurate and reliable. However, no responsibility is assumed by Analog Devices for its use, nor for any infringements of patents or other rights of third parties that may result from its use. Specifications subject to change without notice. No license is granted by implication or otherwise under any patent or patent rights of Analog Devices. Trademarks and registered trademarks are the property of their respective owners.

TABLE OF CONTENTS

| | | | |
|---|----|---|----|
| Features | 1 | Overvoltage Fault Protection | 16 |
| Applications | 1 | ±42 V Miswire Protection | 16 |
| General Description | 1 | RS-485 Network Biasing and Termination | 16 |
| Functional Block Diagram | 1 | IEC ESD, EFT, and Surge Protection | 17 |
| Revision History | 2 | IEC Conducted, Radiated, and Magnetic Immunity..... | 21 |
| Specifications..... | 3 | Applications Information | 23 |
| Timing Specifications | 4 | Radiated Emissions and PCB Layout | 23 |
| Insulation and Safety-Related Specifications..... | 5 | Noise Immunity..... | 23 |
| Package Characteristics | 5 | Fully RS-485 Compliant over an Extended ±25 V Common- Mode Voltage Range | 23 |
| Regulatory Information..... | 5 | 1.7 V to 5.5 V V _{DD1} Logic Supply..... | 23 |
| DIN V VDE V 0884-10 (VDE V 0884-10) Insulation Characteristics | 6 | Truth Tables..... | 24 |
| Absolute Maximum Ratings..... | 7 | Receiver Fail-Safe | 24 |
| Thermal Resistance | 7 | RS-485 Data Rate and Bus Capacitance | 24 |
| ESD Caution..... | 7 | Insulation Wear Out | 24 |
| Pin Configuration and Function Descriptions..... | 8 | Hot Swap Capability..... | 25 |
| Typical Performance Characteristics | 9 | Robust Half-Duplex RS-485 Network..... | 25 |
| Test Circuits..... | 13 | EMC Compliant and Fault Protected Signal and Power Isolated RS-485 Node | 27 |
| Switching Characteristics | 14 | Outline Dimensions | 28 |
| Theory of Operation | 15 | Ordering Guide | 28 |
| RS-485 with Robustness | 15 | | |
| Integrated and Certified IEC EMC Solution | 15 | | |

REVISION HISTORY

1/2020—Rev. A to Rev. B

Added EMC Compliant and Fault Protected Signal and Power Isolated RS485 Node Section, Table 2; Renumbered Sequentially, and Figure 53; Renumbered Sequentially

3/2017—Rev. 0 to Rev. A

Changes to Table 5..... 5
Changes to DIN V VDE V 0884-10 (VDE V 0884-10) Insulation Characteristics Section..... 6

10/2016—Revision 0: Initial Version

SPECIFICATIONS

1.7 V \leq V_{DD1} \leq 5.5 V, 3 V \leq V_{DD2} \leq 5.5 V, T_A = -40°C to +125°C. All minimum/maximum specifications apply over the entire recommended operation range, unless otherwise noted. All typical specifications at T_A = 25°C, V_{DD1} = V_{DD2} = 5.0 V, unless otherwise noted.

Table 1.

| Parameter | Symbol | Min | Typ | Max | Unit | Test Conditions/Comments |
|---|-------------------|----------------------|------|--------------------------------|------------|--|
| SUPPLY CURRENT | | | | | | |
| Power Supply Current | | | | | | |
| Logic Side | I _{DD1} | | | 10 | mA | Unloaded output, DE = V _{DD1} , $\overline{RE} = 0$ V |
| TxD/RxD Data Rate = 2.5 Mbps | | | | 10 | mA | Unloaded output, DE = V _{DD1} , $\overline{RE} = 0$ V |
| Bus Side | I _{DD2} | | | 12 | mA | Unloaded output, DE = V _{DD1} , $\overline{RE} = 0$ V |
| TxD/RxD Data Rate = 2.5 Mbps | | | | 90 | mA | Unloaded output, DE = V _{DD1} , $\overline{RE} = 0$ V |
| | | | | 130 | mA | DE = V _{DD1} , $\overline{RE} = 0$ V, V _{DD2} = 5.5 V, R = 27 Ω , see Figure 27 |
| | | | 94 | | mA | DE = V _{DD1} , $\overline{RE} = 0$ V, V _{DD2} = 5.5 V, R = 27 Ω , see Figure 27 |
| | | | 46 | | mA | DE = V _{DD1} , $\overline{RE} = 0$ V, V _{DD2} = 3.0 V, R = 27 Ω , see Figure 27 |
| Supply Current in Shutdown Mode | I _{SHDN} | | | 10 | mA | DE = 0 V, $\overline{RE} = V_{DD1}$ |
| DRIVER | | | | | | |
| Differential Outputs | | | | | | |
| Differential Output Voltage | V _{OD} | 1.5 | | 5.0 | V | V _{DD2} \geq 3.0 V, R = 27 Ω or 50 Ω , see Figure 27 |
| | | 2.1 | | 5.0 | V | V _{DD2} \geq 4.5 V, R = 27 Ω or 50 Ω , see Figure 27 |
| | V _{OD3} | 1.5 | | 5.0 | V | V _{DD2} \geq 3.0 V, V _{CM} = -25 V to +25 V, see Figure 28 |
| | | 2.1 | | 5.0 | V | V _{DD2} \geq 4.5 V, V _{CM} = -25 V to +25 V, see Figure 28 |
| Change in Differential Output Voltage for Complementary Output States | $\Delta V_{OD} $ | | | 0.2 | V | R = 27 Ω or 50 Ω , see Figure 27 |
| Common-Mode Output Voltage | V _{OC} | | | 3.0 | V | R = 27 Ω or 50 Ω , see Figure 27 |
| Change in Common-Mode Output Voltage for Complementary Output States | $\Delta V_{OC} $ | | | 0.2 | V | R = 27 Ω or 50 Ω , see Figure 27 |
| Short-Circuit Output Current | | | | | | |
| V _{OUT} = Low | I _{OSL} | -250 | | +250 | mA | -42 V \leq V _{SC} \leq +42 V ¹ |
| V _{OUT} = High | I _{OSH} | -250 | | +250 | mA | -42 V \leq V _{SC} \leq +42 V ¹ |
| Logic Inputs (DE, \overline{RE} , TxD) | | | | | | |
| Input Threshold Low | V _{IL} | | | 0.33 \times V _{DD1} | V | 1.7 V \leq V _{DD1} \leq 5.5 V |
| Input Threshold High | V _{IH} | 0.7 V _{DD1} | | | V | 1.7 V \leq V _{DD1} \leq 5.5 V |
| Input Current | I _{TxD} | | | +1 | μ A | 0 V \leq V _{IN} \leq V _{DD1} |
| RECEIVER | | | | | | |
| Differential Inputs | | | | | | |
| Differential Input Threshold Voltage | V _{TH} | -200 | -125 | -30 | mV | -25 V \leq V _{CM} \leq +25 V |
| Input Voltage Hysteresis | V _{HYS} | | 30 | | mV | -25 V \leq V _{CM} \leq +25 V |
| Input Current (A, B) | I _I | -1.0 | | +1.0 | mA | DE = 0 V, V _{DD2} = 0 V/5 V, V _{IN} = \pm 25 V |
| | | -1.0 | | +1.0 | mA | DE = 0 V, V _{DD2} = 0 V/5 V, V _{IN} = \pm 42 V |
| Input Capacitance (A, B) | C _{AB} | | 150 | | pF | T _A = 25°C, see Figure 17 |
| Line Input Resistance | R _{IN} | 96 | | | k Ω | -25 V \leq V _{CM} \leq +25 V, up to 256 nodes supported |

| Parameter | Symbol | Min | Typ | Max | Unit | Test Conditions/Comments |
|---|-------------|-----------------|-----|---------|-------------------|---|
| Logic Outputs | | | | | | |
| Output Voltage Low | V_{OLRXD} | | | 0.2 | V | $I_{ORXD} = 3.0 \text{ mA}$, $V_A - V_B = -0.2 \text{ V}$ |
| Output Voltage High | V_{OHRXD} | $V_{DD1} - 0.2$ | | | V | $I_{ORXD} = -3.0 \text{ mA}$, $V_A - V_B = 0.2 \text{ V}$ |
| Short-Circuit Current | | | | 100 | mA | $V_{OUT} = \text{GND or } V_{DD1}$, $\overline{RE} = 0 \text{ V}$ |
| Three-State Output Leakage Current | I_{OZR} | | | ± 2 | μA | $\overline{RE} = V_{DD1}$, $RxD = 0 \text{ V or } V_{DD1}$ |
| COMMON-MODE TRANSIENT IMMUNITY ² | | 75 | 125 | | kV/ μs | $V_{CM} \geq 1 \text{ kV}$, transient magnitude $\geq 800 \text{ V}$ |

¹ V_{SC} is the short-circuit voltage at the RS-485 A or B bus pin.

² Common-mode transient immunity is the maximum common-mode voltage slew rate that can be sustained while maintaining specification-compliant operation. V_{CM} is the common-mode potential difference between the logic and bus sides. The transient magnitude is the range over which the common mode is slewed. The common-mode voltage slew rates apply to both rising and falling common-mode voltage edges.

TIMING SPECIFICATIONS

$V_{DD1} = 1.7 \text{ V to } 5.5 \text{ V}$, $V_{DD2} = 3.0 \text{ V to } 5.5 \text{ V}$, $T_A = T_{MIN}$ to T_{MAX} (-40°C to $+125^\circ\text{C}$), unless otherwise noted.

Table 2.

| Parameter | Min | Typ | Max | Unit | Test Conditions/Comments |
|--|-----|-----|------|------|--|
| DRIVER ¹ | | | | | |
| Maximum Data Rate | 2.5 | | | Mbps | |
| Propagation Delay, t_{DPLH} , t_{DPHL} | | 30 | 500 | ns | $R_{LDIFF} = 54 \Omega$, $C_{L1} = C_{L2} = 100 \text{ pF}$, see Figure 29 and Figure 33 |
| Differential Skew, t_{SKEW} | | 10 | 50 | ns | $R_{LDIFF} = 54 \Omega$, $C_{L1} = C_{L2} = 100 \text{ pF}$, see Figure 29 and Figure 33 |
| Rise/Fall Times, t_R , t_F | | 40 | 130 | ns | $R_{LDIFF} = 54 \Omega$, $C_{L1} = C_{L2} = 100 \text{ pF}$, see Figure 29 and Figure 33 |
| Enable Time, t_{ZH} , t_{ZL} | | 500 | 2500 | ns | $R_L = 110 \Omega$, $C_L = 50 \text{ pF}$, see Figure 30 and Figure 35 |
| Disable Time, t_{HZ} , t_{LZ} | | 500 | 2500 | ns | $R_L = 110 \Omega$, $C_L = 50 \text{ pF}$, see Figure 30 and Figure 35 |
| RECEIVER ² | | | | | |
| Propagation Delay, t_{PLH} , t_{PHL} | | 120 | 200 | ns | $C_L = 15 \text{ pF}$, see Figure 31 and Figure 34, $10, V_{ID} \geq \pm 1.5 \text{ V}$ |
| | | 140 | 220 | ns | $C_L = 15 \text{ pF}$, see Figure 31 and Figure 34, $V_{ID} \geq \pm 600 \text{ mV}$ |
| Skew, t_{SKEW} | | 4 | 40 | ns | $C_L = 15 \text{ pF}$, see Figure 31 and Figure 34, $V_{ID} \geq \pm 1.5 \text{ V}$ |
| Enable Time | | 10 | 50 | ns | $R_L = 1 \text{ k}\Omega$, $C_L = 15 \text{ pF}$, see Figure 32 and Figure 36 |
| Disable Time | | 10 | 50 | ns | $R_L = 1 \text{ k}\Omega$, $C_L = 15 \text{ pF}$, see Figure 32 and Figure 36 |
| RxD Pulse Width Distortion | | | 40 | ns | $C_L = 15 \text{ pF}$, see Figure 31 and Figure 34, $V_{ID} \geq \pm 1.5 \text{ V}$ |

¹ See Figure 29 for the definition of R_{LDIFF} .

² Receiver propagation delay, skew, and pulse width distortion specifications are tested with a receiver differential input voltage (V_{ID}) of $\geq \pm 600 \text{ mV}$ or $\geq \pm 1.5 \text{ V}$, as noted.

INSULATION AND SAFETY-RELATED SPECIFICATIONS

For additional information, see www.analog.com/icouplersafety.

Table 3.

| Parameter | Symbol | Value | Unit | Conditions |
|---|--------|-------|--------|--|
| Rated Dielectric Insulation Voltage | | 5000 | V rms | 1 minute duration |
| Minimum External Air Gap (Clearance) | L(I01) | 7.8 | mm min | Measured from input terminals to output terminals, shortest distance through air |
| Minimum External Tracking (Creepage) | L(I02) | 7.8 | mm min | Measured from input terminals to output terminals, shortest distance along body |
| Minimum Clearance in the Plane of the Printed Circuit Board (PCB Clearance) | L(PCB) | 8.3 | mm min | Measured from input terminals to output terminals, shortest distance through air, line of sight, in the PCB mounting plane |
| Minimum Internal Gap (Internal Clearance) | | 25.5 | µm min | Minimum distance through insulation |
| Tracking Resistance (Comparative Tracking Index) | CTI | >400 | V | DIN IEC 112/VDE 0303 Part 1 |
| Material Group | | II | | Material Group (DIN VDE 0110, 1/89) |

PACKAGE CHARACTERISTICS

Table 4.

| Parameter | Symbol | Min | Typ | Max | Unit | Test Conditions/Comments |
|--|------------------|-----|------------------|-----|------|---|
| Resistance (Input to Output) ¹ | R _{I-O} | | 10 ¹³ | | Ω | |
| Capacitance (Input to Output) ¹ | C _{I-O} | | 2.2 | | pF | f = 1 MHz |
| Input Capacitance ² | C _I | | 4.0 | | pF | |
| Input Capacitance, A and B Pins | C _{AB} | | 150 | | pF | T _A = 25°C, see Figure 17 |
| IC Junction to Ambient Thermal Resistance | θ _{JA} | | 59.7 | | °C/W | Thermocouple located at center of package underside |

¹ The device is considered a 2-terminal device: Pin 1 through Pin 8 are shorted together, and Pin 9 through Pin 16 are shorted together.

² Input capacitance is from any digital input pin to ground.

REGULATORY INFORMATION

See Table 8 and the Insulation Wear Out section for details regarding recommended maximum working voltages for specific cross isolation waveforms and insulation levels. The ADM2795E is approved or pending approval by the organizations listed in Table 5.

Table 5. ADM2795E Approvals

| UL | CSA | VDE | CQC (Pending) |
|---|---|--|--|
| Recognized Under UL 1577 Component Recognition Program ¹ | Approved under CSA Component Acceptance Notice 5A | Certified according to DIN V VDE V 0884-10 (VDE V 0884-10):2006-12 ² | Certified by CQC11-471543-2012, GB4943.1-2011 |
| Single Protection, 5000 V rms Isolation Voltage | CSA 60950-1-07+A1+A2 and IEC 60950-1 second edition +A1+A2: Basic insulation at 780 V rms (1103 V peak) Reinforced insulation at 390 V rms (552 V peak) IEC 60601-1 Edition 3.1: 1 means of patient protection (MOPP), 400 V rms (566 V peak) 2 MOPP, 237 V rms (335 V peak) CSA 61010-1-12+A1 and IEC 61010-1 third edition: Basic insulation at 600 V rms mains (Overvoltage Category III), 780 V secondary (1103 V peak) | Reinforced insulation, V _{IORM} = 849 V peak, V _{IOSM} = 8000 V peak | Basic insulation at 780 V rms (1103 V peak) Reinforced insulation at 389 V rms (552 V peak) |
| File E214100 | File 205078 | File 2471900-4880-0001/231230 | File (pending) |

¹ In accordance with UL 1577, each ADM2795E is proof tested by applying an insulation test voltage ≥6000 V rms for 1 sec.

² In accordance with DIN V VDE V 0884-10, each ADM2795E is proof tested by applying an insulation test voltage ≥1592 V peak for 1 sec.

DIN V VDE V 0884-10 (VDE V 0884-10) INSULATION CHARACTERISTICS

This isolator is suitable for reinforced electrical isolation only within the safety limit data. Maintenance of the safety data must be ensured by means of protective circuits.

An asterisk (*) on a package denotes VDE 0884 approval for an 849 V peak working voltage.

Table 6.

| Description | Test Conditions/Comments | Symbol | Characteristic | Unit |
|--|--|-------------------|------------------|--------|
| Installation Classification per DIN VDE 0110 for Rated Mains Voltage | | | I to IV | |
| ≤150 V rms | | | I to IV | |
| ≤300 V rms | | | I to III | |
| ≤400 V rms | | | 40/125/21 | |
| Climatic Classification | | | 2 | |
| Pollution Degree (DIN VDE 0110, see Table 3) | | | | |
| Maximum Working Insulation Voltage | | V _{IORM} | 849 | V peak |
| Input to Output Test Voltage, Method b1 | V _{IORM} × 1.875 = V _{PR} , 100% production tested, t _m = 1 sec, partial discharge < 5 pC | V _{PR} | 1592 | V peak |
| Input to Output Test Voltage, Method a | | V _{PR} | | |
| After Environmental Tests, Subgroup 1 | V _{IORM} × 1.5 = V _{PR} , t _m = 60 sec, partial discharge < 5 pC | | 1274 | V peak |
| After Input and/or Safety Test, Subgroup 2/Subgroup 3 | V _{IORM} × 1.2 = V _{PR} , t _m = 60 sec, partial discharge < 5 pC | | 1019 | V peak |
| Highest Allowable Overvoltage | Transient overvoltage, t _{TR} = 10 sec | V _{IOTM} | 7000 | V peak |
| Reinforced Surge Isolation Voltage | V _{PEAK} = 12.8 kV, 1.2 μs rise time, 50 μs, 50% fall time | V _{IOSM} | 8000 | V peak |
| Safety Limiting Values | Maximum value allowed in the event of a failure, see Figure 2 | T _S | 150 | °C |
| Total Power Dissipation at T _A = 25°C | | P _S | 1.80 | W |
| Insulation Resistance at T _S | V _{IO} = 500 V | R _S | >10 ⁹ | Ω |



Figure 2. Thermal Derating Curve for RW-16 Wide Body [SOIC_W] Package, Dependence of Safety Limiting Values with Ambient Temperature per DIN V VDE V 0884-10

ABSOLUTE MAXIMUM RATINGS

$T_A = 25^\circ\text{C}$, unless otherwise noted.

Table 7.

| Parameter | Rating |
|---|---|
| V_{DD1} | -0.5 V to +7 V |
| V_{DD2} | -0.5 V to +7 V |
| Digital Input/Output Voltage (DE, $\overline{\text{RE}}$, TxD, RxD) | -0.3 V to $V_{DD1} + 0.3\text{ V}$ |
| Driver Output/Receiver Input Voltage | $\pm 48\text{ V}$ |
| Operating Temperature Range | -40°C to $+125^\circ\text{C}$ |
| Storage Temperature Range | -65°C to $+150^\circ\text{C}$ |
| Maximum Junction Temperature | 150°C |
| Continuous Total Power Dissipation | 405 mW |
| Lead Temperature | |
| Soldering (10 sec) | 300°C |
| Vapor Phase (60 sec) | 215°C |
| Infrared (15 sec) | 220°C |
| ESD (A, B Pins Tested to GND ₂) | |
| IEC 61000-4-2 Contact Discharge | $\pm 8\text{ kV}$ |
| IEC 62000-4-2 Air Discharge | $\pm 15\text{ kV}$ |
| EFT (A, B Pins Tested to GND ₂) | |
| IEC 61000-4-4 Level 4 EFT Protection | $\pm 2\text{ kV}$ |
| Surge (A, B Pins Tested to GND ₂) | |
| IEC 61000-4-5 Level 4 Surge Protection | $\pm 4\text{ kV}$ |
| EMC Performance from A, B Bus Pins Across the Isolation Barrier to GND ₁ | |
| ESD | |
| IEC 61000-4-2 Contact Discharge | $\pm 9\text{ kV}$ |
| IEC 61000-4-2 Air Discharge | $\pm 8\text{ kV}$ |
| EFT | |
| IEC 61000-4-4 | $\pm 2\text{ kV}$ |
| Surge | |
| IEC 61000-4-5 | $\pm 4\text{ kV}$ |
| HBM ESD Protection (A, B Pins Tested to GND ₂) | $> \pm 30\text{ kV}$ |
| HBM ESD Protection (All Pins) | $\pm 6\text{ kV}$ |
| Field Induced Charged Device Model ESD (FICDM) | $\pm 1.25\text{ kV}$ |

Stresses at or above those listed under Absolute Maximum Ratings may cause permanent damage to the product. This is a stress rating only; functional operation of the product at these or any other conditions above those indicated in the operational section of this specification is not implied. Operation beyond the maximum operating conditions for extended periods may affect product reliability.

Table 8. Maximum Continuous Working Voltage¹

| Parameter | Max | Unit | Reference Standard ² |
|-----------------------|------|--------|---|
| AC Voltage | | | |
| Bipolar Waveform | | | |
| Basic Insulation | 849 | V peak | 50-year minimum insulation lifetime |
| Reinforced Insulation | 768 | V peak | Lifetime limited by package creepage maximum approved working voltage per IEC 60950-1 |
| Unipolar Waveform | | | |
| Basic Insulation | 1698 | V peak | 50-year minimum insulation lifetime |
| Reinforced Insulation | 885 | V peak | Lifetime limited by package creepage maximum approved working voltage per IEC 60950-1 |
| DC Voltage | | | |
| Basic Insulation | 1092 | V peak | Lifetime limited by package creepage maximum approved working voltage per IEC 60950-1 |
| Reinforced Insulation | 543 | V peak | Lifetime limited by package creepage maximum approved working voltage per IEC 60950-1 |

¹ The maximum continuous working voltage refers to the continuous voltage magnitude imposed across the isolation barrier. See the Insulation Wear Out section for more details.

² Insulation lifetime for the specified test condition is greater than 50 years.

THERMAL RESISTANCE

Thermal performance is directly linked to PCB design and operating environment. Careful attention to PCB thermal design is required.

θ_{JA} is the natural convection junction to ambient thermal resistance measured in a one cubic foot sealed enclosure. θ_{JC} is the junction to case thermal resistance.

Table 9. Thermal Resistance

| Package Type | θ_{JA} ¹ | θ_{JC} ¹ | Unit |
|--------------|----------------------------|----------------------------|---------------------------|
| RW-16 | 59.7 | 28.3 | $^\circ\text{C}/\text{W}$ |

¹ Thermal impedance simulated values are based on a JEDEC 252P thermal test board with no vias. See JEDEC JESD51.

ESD CAUTION



ESD (electrostatic discharge) sensitive device. Charged devices and circuit boards can discharge without detection. Although this product features patented or proprietary protection circuitry, damage may occur on devices subjected to high energy ESD. Therefore, proper ESD precautions should be taken to avoid performance degradation or loss of functionality.

PIN CONFIGURATION AND FUNCTION DESCRIPTIONS

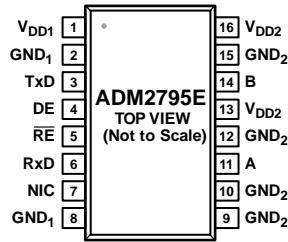

NOTES
1. NIC = NOT INTERNALLY CONNECTED.

Figure 3. Pin Configuration

Table 10. Pin Function Descriptions

| Pin No. | Mnemonic | Description |
|---------|------------------------|--|
| 1 | V _{DD1} | 1.7 V to 5.5 V Flexible Logic Interface Supply. |
| 2 | GND ₁ | Ground 1, Logic Side. |
| 3 | TxD | Transmit Data Input. Data to be transmitted by the driver is applied to this input. |
| 4 | DE | Driver Output Enable. A high level on this pin enables the driver differential outputs, A and B. A low level places them into a high impedance state. |
| 5 | $\overline{\text{RE}}$ | Receiver Enable Input. This pin is an active low input. Driving this input low enables the receiver, and driving it high disables the receiver. |
| 6 | RxD | Receiver Output Data. This output is high when $(A - B) > -30 \text{ mV}$ and low when $(A - B) < -200 \text{ mV}$. |
| 7 | NIC | Not Internally Connected. This pin is not internally connected. |
| 8 | GND ₁ | Ground 1, Logic Side. |
| 9 | GND ₂ | Isolated Ground 2, Bus Side. |
| 10 | GND ₂ | Isolated Ground 2, Bus Side. |
| 11 | A | Noninverting Driver Output/Receiver Input. When the driver is disabled, or when V _{DD1} or V _{DD2} is powered down, Pin A is put into a high impedance state to avoid overloading the bus. |
| 12 | GND ₂ | Isolated Ground 2, Bus Side. |
| 13 | V _{DD2} | 3 V to 5.5 V Power Supply. Pin 13 must be connected externally to Pin 16. |
| 14 | B | Inverting Driver Output/Receiver Input. When the driver is disabled, or when V _{DD1} or V _{DD2} is powered down, Pin B is put into a high impedance state to avoid overloading the bus. |
| 15 | GND ₂ | Isolated Ground 2, Bus Side. |
| 16 | V _{DD2} | 3 V to 5.5 V Power Supply. Pin 16 must be connected externally to Pin 13. |

TYPICAL PERFORMANCE CHARACTERISTICS



Figure 4. Supply Current (I_{CC}) vs. Temperature at $R_L = 54\Omega$, 120Ω , and No Load; Data Rate = 2.5 Mbps, $V_{DD1} = 5.5\text{ V}$, $V_{DD2} = 5.5\text{ V}$

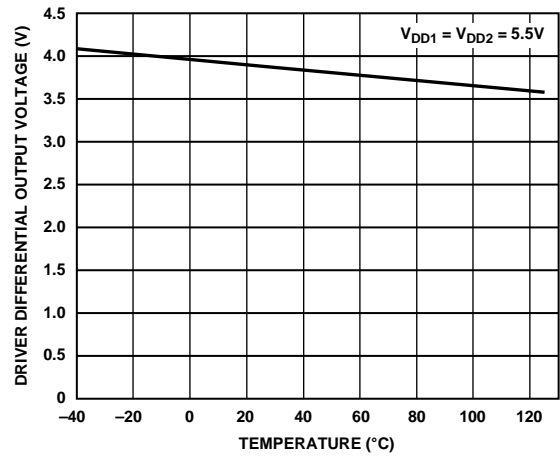

Figure 7. Driver Differential Output Voltage vs. Temperature



Figure 5. Supply Current (I_{CC}) vs. Temperature at $R_L = 54\Omega$, 120Ω , and No Load; Data Rate = 2.5 Mbps, $V_{DD1} = 1.7\text{ V}$, $V_{DD2} = 3.0\text{ V}$

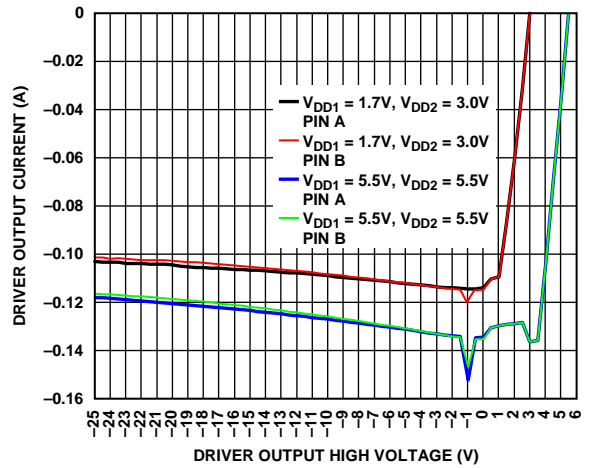

Figure 8. Driver Output Current vs. Driver Output High Voltage



Figure 6. Driver Output Current vs. Differential Output Voltage

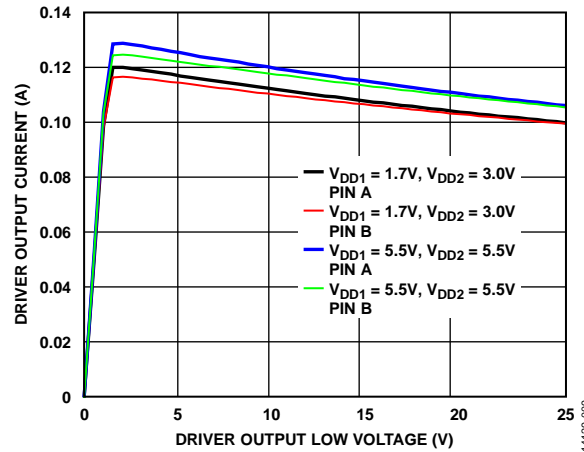

Figure 9. Driver Output Current vs. Driver Output Low Voltage



Figure 10. Driver Differential Propagation Delay vs. Temperature



Figure 13. Receiver Output Current vs. Receiver Output Low Voltage

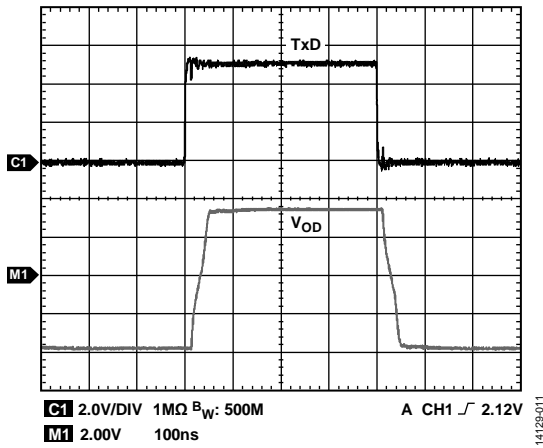

Figure 11. Driver Propagation Delay (Oscilloscope)

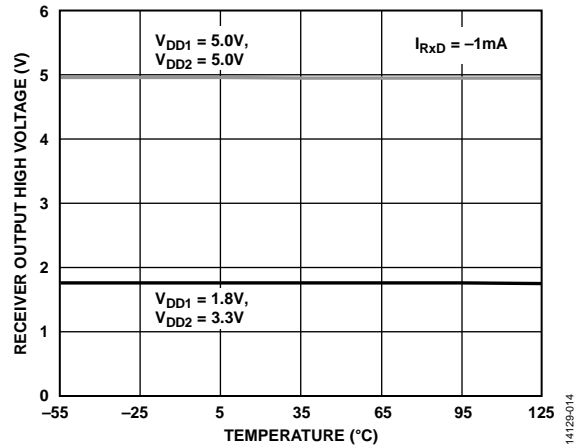

Figure 14. Receiver Output High Voltage vs. Temperature



Figure 12. Receiver Output Current vs. Receiver Output High Voltage

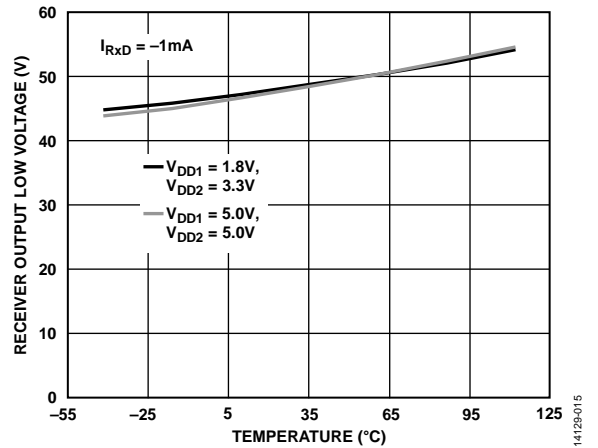

Figure 15. Receiver Output Low Voltage vs. Temperature

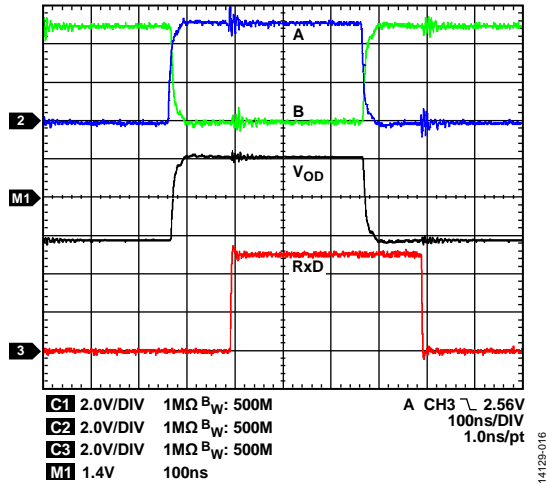

Figure 16. Receiver Propagation Delay (Oscilloscope)



Figure 19. Receiver Propagation Delay vs. Temperature



Figure 17. Input Capacitance (A, B) vs. Junction Temperature



Figure 20. Receiver Performance with Input Common-Mode Voltage of 25 V



Figure 18. Radiated Emissions Profile with 120 pF Capacitor to GND, on the RxD Pin (Horizontal Scan, Data Rate = 2.5 Mbps, V_{DD1} = V_{DD2} = 5.0 V)

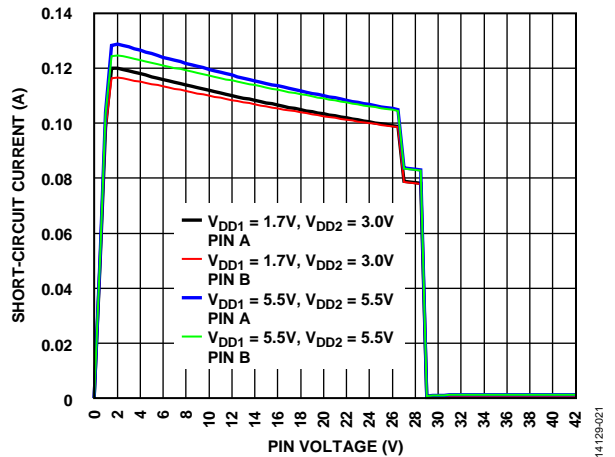

Figure 21. Short-Circuit Current over Fault Voltage Range

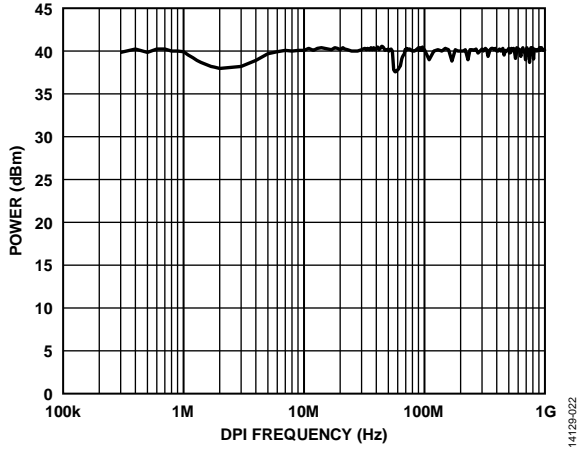

Figure 22. DPI IEC 62132-4 Noise Immunity with 100 nF and 10 μ F Decoupling on V_{DD1}

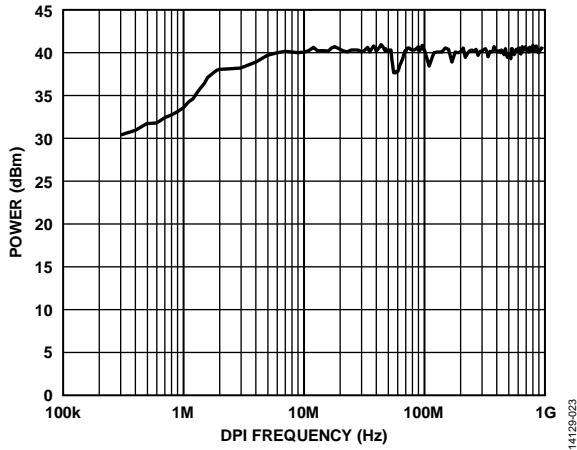

Figure 23. DPI IEC 62132-4 Noise Immunity with 100 nF Decoupling on V_{DD1}

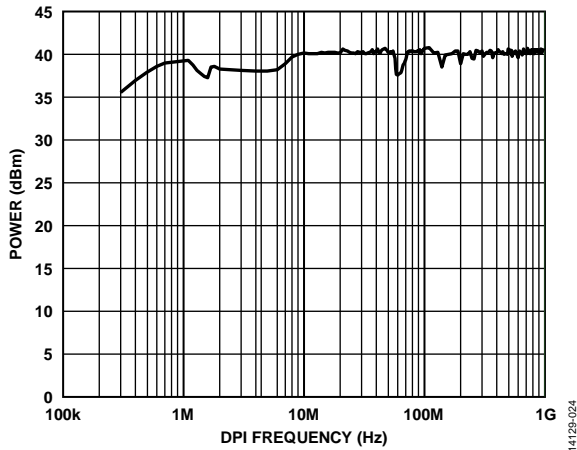

Figure 24. DPI IEC 62132-4 Noise Immunity with 100 nF and Decoupling on V_{DD2}



Figure 25. Receiver Input Differential Voltage (V_{ID}) vs. Signaling Rate

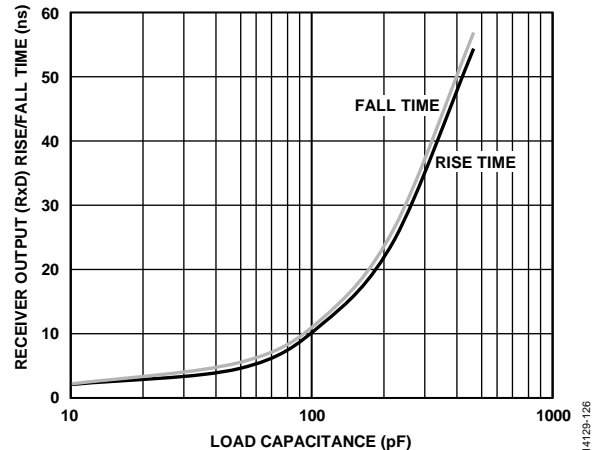

Figure 26. Receiver Output (RxD) Rise/Fall Time vs. Load Capacitance

TEST CIRCUITS



Figure 27. Driver Voltage Measurement

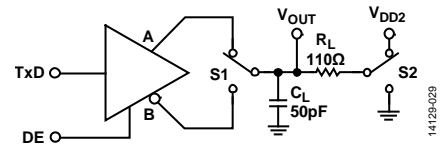

Figure 30. Driver Enable/Disable

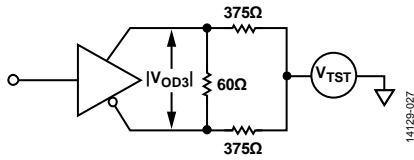

Figure 28. Driver Voltage Measurement over Common-Mode Voltage Range

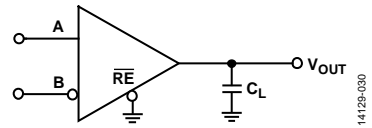

Figure 31. Receiver Propagation Delay

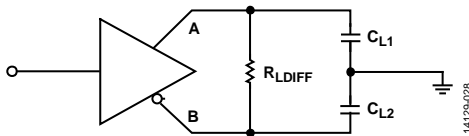

Figure 29. Driver Propagation Delay

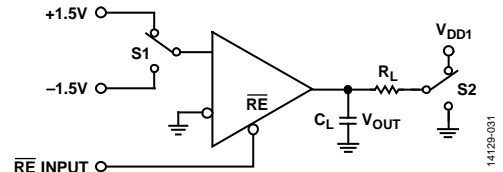

Figure 32. Receiver Enable/Disable

SWITCHING CHARACTERISTICS



Figure 33. Driver Propagation Delay, Rise/Fall Timing

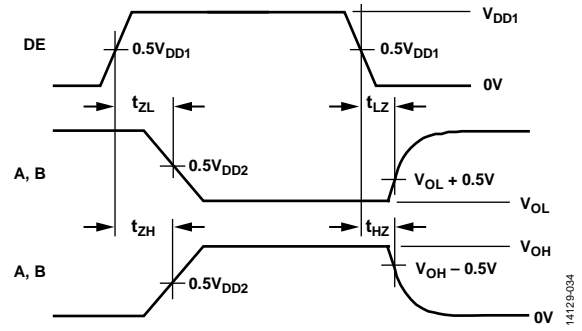

Figure 35. Driver Enable/Disable Timing

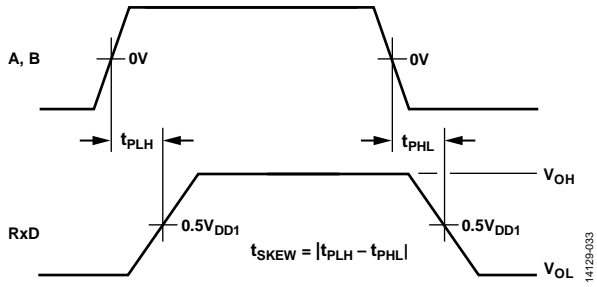

Figure 34. Receiver Propagation Delay

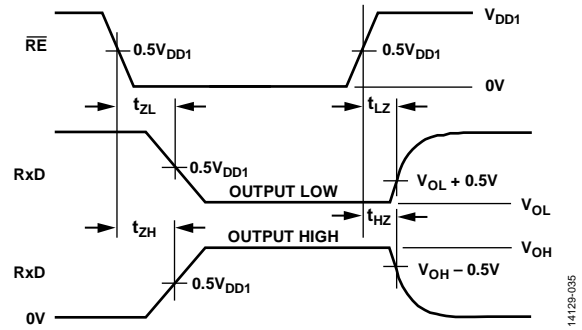

Figure 36. Receiver Enable/Disable Timing

THEORY OF OPERATION

RS-485 WITH ROBUSTNESS

The [ADM2795E](#) is a 3 V to 5.5 V RS-485/RS-422 transceiver with robustness that reduces system failures when operating in harsh application environments.

The [ADM2795E](#) is an RS-485/RS-422 transceiver that integrates IEC 61000-4-5 Level 4 surge protection, allowing up to ± 4 kV of protection on the RS-485 bus pins without the need for external protection components such as transient voltage suppressors (TVS) or TISP® surge protectors. The [ADM2795E](#) has IEC 61000-4-4 Level 4 EFT protection up to ± 2 kV and IEC 61000-4-2 Level 4 ESD protection on the bus pins.

The [ADM2795E](#) is an RS-485 transceiver that offers a defined level of overvoltage fault protection in addition to IEC 61000-4-2 ESD, IEC 61000-4-4 EFT, and IEC 61000-4-5 surge protection for the RS-485 bus pins.

INTEGRATED AND CERTIFIED IEC EMC SOLUTION

The driver outputs/receiver inputs of RS-485 devices often experience high voltage faults resulting from short circuits to power supplies that exceed the -7 V to $+12$ V range specified in the TIA/EIA-485-A standard. Typically, RS-485 applications require costly external protection devices, such as positive temperature coefficient (PTC) fuses, for operation in these harsh electrical environments. In harsh electrical environments, system designers also must consider common EMC problems, choosing components to provide IEC 61000-4-2 ESD, IEC 61000-4-4 EFT, and IEC 61000-4-5 surge protection for the RS-485 bus pins.

In choosing suitable EMC protection components, the system designer is faced with two challenges: complying with EMC regulations, and matching the dynamic breakdown characteristics of the EMC protection to the RS-485 transceiver. To overcome these challenges, the designer may need to run multiple design, test, and printed circuit board (PCB) board iterations, leading to a slower time to market and project budget overruns.

To reduce system cost and design complexity, the [ADM2795E](#) provides certified integrated EMC protection and overvoltage fault protection on the RS-485 bus pins. The [ADM2795E](#) integrated EMC and overvoltage fault protection circuits are optimally performance matched, saving the circuit designer significant design and testing time.

Figure 37 shows an isolated EMC protected RS-485 circuit layout example, which targets IEC 61000-4-2 ESD Level 4, IEC 61000-4-4 EFT Level 4, and IEC 61000-4-5 surge protection to Level 4 for the RS-485 bus pins. This circuit uses several discrete components, including two TISP surge protectors, two transient blocking units (TBUs), and one dual TVS. Due to the integrated protection components of the [ADM2795E](#), the PCB area is significantly reduced when compared to a solution with discrete EMC protection components.



Figure 37. [ADM2795E](#) Certified Integrated IEC 61000-4-5 Surge Solution, Saving the Designer Significant PCB Area

OVERVOLTAGE FAULT PROTECTION

The ADM2795E is an RS-485 transceiver that offers fault protection over a 3 V to 5.5 V V_{DD2} operating range without the need for close examination of the logic pin state (TxD input and the DE and RE enable pins) of the RS-485 transceiver. The transceiver is also fault protected over the entire extended common-mode operating range of ± 25 V.

The ADM2795E RS-485 driver outputs/receiver inputs are protected from short circuits to any voltage within the range of -42 V to $+42$ V ac/dc peak. The maximum short-circuit output current in a fault condition is ± 250 mA. The RS-485 driver includes a foldback current limiting circuit that reduces the driver current at voltages above the ± 25 V common-mode range limit of the transceiver (see Figure 21 in the Typical Performance Characteristics section). This current reduction due to the foldback feature allows better management of power dissipation and heating effects.

± 42 V MISWIRE PROTECTION

The ADM2795E is protected against high voltage miswire events when it operates on a bus that does not have RS-485 termination or bus biasing resistors installed. A typical miswire event is where a high voltage 24 V ac/dc power supply is connected directly to RS-485 bus pin connectors. The ADM2795E can withstand miswiring faults of up to ± 42 V peak on the RS-485 bus pins with respect to GND_2 without damage. Miswiring protection is guaranteed on the ADM2795E RS-485 A and B bus pins, and is guaranteed in the case of a hot swap of connectors to the bus pins. Table 11 and Table 12 provide a summary of the high voltage miswire protection offered by the ADM2795E. The ADM2795E is tested with ± 42 V dc and with ± 24 V $\pm 20\%$ rms, 50 Hz/60 Hz, with both a hot plug and dc ramp test waveforms. The test is performed in both powered and unpowered/floating power supply cases, and at a range of different states for the RS-485 TxD input and the DE and RE enable pins. The RS-485 bus pins survive a high voltage miswire from Pin A to GND_2 , from Pin B to GND_2 , and between Pin A and Pin B.

Table 11. Miswire Protection Table Abbreviations

| Letter | Description |
|--------|------------------------------|
| H | High level for logic pin |
| L | Low level for logic pin |
| X | On or off power supply state |

Table 12. High Voltage Miswire Protection

| Supply | | Inputs | | | Miswire Protection at RS-485 Outputs Pins ^{1,2} |
|-----------|-----------|--------|-----|-----|--|
| V_{DD1} | V_{DD2} | DE | RE | TxD | |
| X | X | H/L | H/L | H/L | -42 V dc $\leq V_A \leq +42$ V dc |
| X | X | H/L | H/L | H/L | -42 V dc $\leq V_B \leq +42$ V dc |
| X | X | H/L | H/L | H/L | -42 V ac $\leq V_A \leq +42$ V ac |
| X | X | H/L | H/L | H/L | -42 V ac $\leq V_B \leq +42$ V ac |

¹ This is the ac/dc peak miswire voltage between Pin A and GND_2 , or Pin B and GND_2 , or between Pin A and Pin B.

² V_A refers to the voltage on Pin A, and V_B refers to the voltage on Pin B.

RS-485 NETWORK BIASING AND TERMINATION

For a high voltage miswire on the RS-485 A and B bus pins with biasing and termination resistors installed, there is a current path through the biasing network to the ADM2795E power supply pin, V_{DD2} . To protect the ADM2795E in this scenario, the device has an integrated V_{DD2} protection circuit.

The ADM2795E is a fault protected RS-485 device that also features protection for its power supply pin. This means that the current path through the R1 pull-up resistor does not cause damage to the V_{DD2} pin, although the pull-up resistor itself can be damaged if not appropriately power rated (see Figure 38). The R1 pull-up resistor power rating depends on the miswire voltage and the resistance value.

If there is a miswire between the A and B pins in the Figure 38 bus setup, the ADM2795E is protected, but the RT bus termination resistor can be damaged if not appropriately power rated. The RT termination resistor power rating depends on the miswire voltage and the resistance value.



Figure 38. High Voltage Miswiring Protection for the ADM2795E with Bus Termination and Biasing Resistor

IEC ESD, EFT, AND SURGE PROTECTION

Electrical and electronic equipment must be designed to meet system level IEC standards. The following are example system level IEC standards:

- Process control and automation: IEC 61131-2
- Motor control: IEC 61800-3
- Building automation: IEC 60730-1

For data communication lines, these system level standards specify varying levels of protection against the following three types of high voltage transients:

- IEC 61000-4-2 ESD
- IEC 61000-4-4 EFT
- IEC 61000-4-5 surge

Each of these specifications defines a test method to assess the immunity of electronic and electrical equipment against the defined phenomenon. The following sections summarize each of these tests. The ADM2795E is fully tested in accordance with these IEC EMC specifications, and is certified IEC EMC compliant.

Electrostatic Discharge (ESD)

ESD is the sudden transfer of electrostatic charge between bodies at different potentials caused by near contact or induced by an electric field. ESD has the characteristics of high current in a short time period. The primary purpose of the IEC 61000-4-2 test is to determine the immunity of systems to external ESD events outside the system during operation. IEC 61000-4-2 describes testing using the following two coupling methods: contact discharge and air gap discharge. Contact discharge implies a direct contact between the discharge gun and the unit under test. During air discharge testing, the charged electrode of the discharge gun is moved toward the unit under test until a discharge occurs as an arc across the air gap. The discharge gun does not make direct contact with the unit under test. A number of factors affect the results and repeatability of the air discharge test,

including humidity, temperature, barometric pressure, distance, and rate of approach to the unit under test. This method is a better representation of an actual ESD event but is not as repeatable. Therefore, contact discharge is the preferred test method.

During testing, the data port is subjected to at least 10 positive and 10 negative single discharges with a minimum 1 sec interval between each pulse. Selection of the test voltage is dependent on the system end environment.

Figure 39 shows the 8 kV contact discharge current waveform as described in the IEC 61000-4-2 specification. Some of the key waveform parameters are rise times of less than 1 ns and pulse widths of approximately 60 ns.



Figure 39. IEC 61000-4-2 ESD Waveform (8 kV)

Figure 40 shows an example test setup where the ADM2795E evaluation board is tested to both contact discharge and air discharge for the IEC 61000-4-2 ESD standard.

Testing was performed with the IEC ESD gun connected to the local bus, GND₂. In testing to GND₂, the ADM2795E is robust to IEC 61000-4-2 events and passes the highest level recognized in the standard, Level 4, which defines a contact discharge voltage of ±8 kV and an air discharge voltage of ±15 kV.



Figure 40. IEC 61000-4-2 ESD Testing to GND₁ or GND₂

Testing was also performed with the IEC ESD gun connected to the logic side GND₁. Testing to GND₁ demonstrates the robustness of the ADM2795E isolation barrier. The isolation barrier is capable of withstanding IEC 61000-4-2 ESD to ±9 kV contact and to ±8 kV air. Testing was performed in normal transceiver operation, with the ADM2795E clocking data at 2.5 Mbps. Table 13 and Table 16 summarize the certified test results.

Table 13. IEC 61000-4-2 Certified Test Results

| ESD Gun Connected to | IEC 61000-4-2 Test Result | Certified Result |
|----------------------|---|------------------|
| GND ₂ | ±15 kV (air), ±8 kV (contact), Level 4 protection | Yes |
| GND ₁ | Withstands ±8 kV (air), ±9 kV (contact) | Yes |

Figure 41 shows the 8 kV contact discharge current waveform from the IEC 61000-4-2 standard compared to the HBM ESD 8 kV waveform. Figure 41 shows that the two standards each specify a very different waveform shape and peak current. The peak current associated with a IEC 61000-4-2 8 kV pulse is 30 A, while the corresponding peak current for HBM ESD is more than five times less, at 5.33 A. The other difference is the rise time of the initial voltage spike, with IEC 61000-4-2 ESD having a much faster rise time of 1 ns, compared to the 10 ns associated with the HBM ESD waveform. The amount of power associated with an IEC ESD waveform is much greater than that of an HBM ESD waveform. The ADM2795E with IEC 61000-4-2 ESD ratings is better suited for operation in harsh environments compared to other RS-485 transceivers that state varying levels of HBM ESD protection.

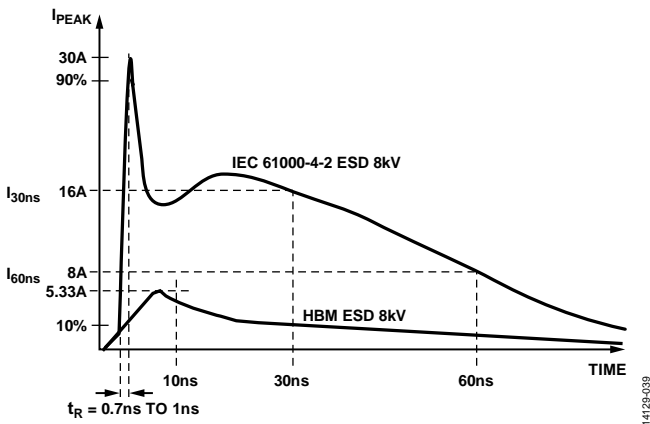

Figure 41. IEC 61000-4-2 ESD Waveform (8 kV) Compared to HBM ESD Waveform (8 kV)

Electrical Fast Transients (EFTs)

EFT testing involves coupling a number of extremely fast transient impulses onto the signal lines to represent transient disturbances (associated with external switching circuits that are capacitively coupled onto the communication ports), which may include relay and switch contact bounce or transients originating from the switching of inductive or capacitive loads—all of which are very common in industrial environments. The EFT test defined

in IEC 61000-4-4 attempts to simulate the interference resulting from these types of events.

Figure 42 shows the EFT 50 Ω load waveforms. The EFT waveform is described in terms of a voltage across a 50 Ω impedance from a generator with a 50 Ω output impedance. The output waveform consists of a 15 ms burst of 5 kHz high voltage transients repeated at 300 ms intervals. The EFT test is also performed with a 750 μs burst at a higher 100 kHz frequency. Each individual pulse has a rise time of 5 ns and a pulse duration of 50 ns, measured between the 50% point on the rising and falling edges of the waveform. The total energy in a single EFT pulse is similar to that in an ESD pulse.

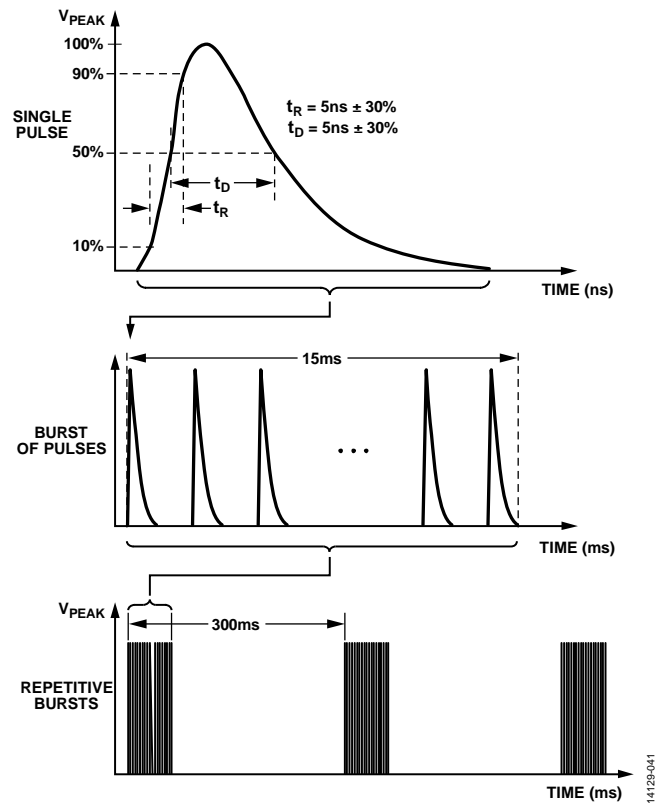

Figure 42. IEC 61000-4-4 EFT 50 Ω Load Waveforms

During testing, these EFT fast burst transients are coupled onto the communication lines using a capacitive clamp, as shown in Figure 43. The EFT is capacitively coupled onto the communication lines by the clamp rather than direct contact. This clamp also reduces the loading caused by the low output impedance of the EFT generator. The coupling capacitance between the clamp and cable depends on cable diameter, shielding, and insulation on the cable. The EFT clamp edge is placed 50 cm from the equipment under test (EUT) (ADM2795E evaluation board). The EFT generator is set up for either 5 kHz or 100 kHz repetitive EFT bursts. The ADM2795E was tested in both 5 kHz and 100 kHz test setups.

With the EFT clamp connected to GND₂, the ADM2795E is robust to IEC 61000-4-4 EFT transients and protects against the highest level recognized in the standard, Level 4, which defines

a voltage level of ± 2 kV. With the IEC 61000-4-4 EFT clamp connected to GND_1 , the ADM2795E is robust to IEC 61000-4-4 EFT transients and withstands up to ± 2 kV. Testing was performed in normal transceiver operation, with the ADM2795E clocking data at 2.5 Mbps. The results shown in Table 14 are valid for a setup with or without an RS-485 cable shield connection to GND_2 . The ADM2795E withstands up to ± 2 kV IEC 61000-4-4 EFT without damage. Table 14 and Table 16 summarize the certified test results.

Table 14. IEC 61000-4-4 Certified Test Results

| EFT Clamp Connected to | IEC 61000-4-4 Test Result | Certified Result |
|------------------------|-------------------------------|------------------|
| GND_2 | ± 2 kV Level 4 protection | Yes |
| GND_1 | Withstands ± 2 kV | Yes |

Surge

Surge transients are caused by overvoltage from switching or lightning transients. Switching transients can result from power system switching, load changes in power distribution systems, or various system faults such as short circuits. Lightning transients can be a result of high currents and voltages injected into the circuit from nearby lightning strikes. IEC 61000-4-5

defines waveforms, test methods, and test levels for evaluating immunity against these destructive surges.

The waveforms are specified as the outputs of a waveform generator in terms of open circuit voltage and short-circuit current. Two waveforms are described. The $10 \mu s/700 \mu s$ combination waveform is used to test ports intended for connection to symmetrical communication lines: for example, telephone exchange lines. The $1.2 \mu s/50 \mu s$ combination waveform generator is used in all other cases, in particular short distance signal connections. For RS-485 ports, the $1.2 \mu s/50 \mu s$ waveform is predominantly used and is described in this section. The waveform generator has an effective output impedance of 2Ω ; therefore, the surge transient has high currents associated with it.

Figure 44 shows the $1.2 \mu s$ and $50 \mu s$ surge transient waveform. ESD and EFT have similar rise times, pulse widths, and energy levels; however, the surge pulse has a rise time of $1.25 \mu s$ and the pulse width is $50 \mu s$. Additionally, the surge pulse energy is three to four orders of magnitude larger than the energy in an ESD or EFT pulse. Therefore, the surge transient is considered the most severe of the EMC transients.

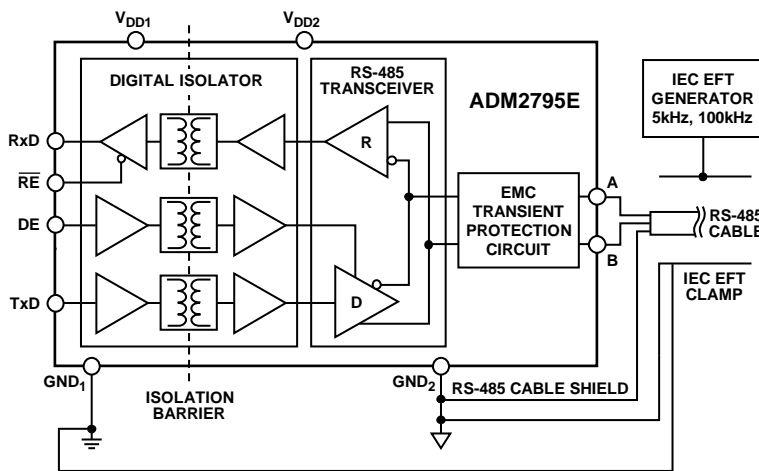

Figure 43. IEC 61000-4-4 EFT Testing to GND_1 or GND_2



Figure 44. IEC 61000-4-5 Surge $1.2 \mu s/50 \mu s$ Waveform



Figure 45. IEC 61000-4-5 Surge Testing to GND₁ or GND₂

IEC 61000-4-5 surge testing involves using a coupling/decoupling network (CDN) to couple the surge transient into the RS-485 A and B bus pins. The coupling network for a half-duplex RS-485 device consists of an 80 Ω resistor on both the A and B lines and a coupling device. The total parallel sum of the resistance is 40 Ω. The coupling device can be capacitors, gas arrestors, clamping devices, or any method that allows the EUT to function correctly during the applied test. During the surge test, five positive and five negative pulses are applied to the data ports with a maximum time interval of one minute between each pulse. The standard states that the device must be set up in normal operating conditions for the duration of the test. Figure 45 shows the test setup for surge testing. Testing is performed in normal transceiver operation, with the ADM2795E clocking data at 2.5 Mbps.

With the IEC surge generator connected to GND₂, the ADM2795E is robust to IEC 61000-4-5 events and protects against the highest level recognized in the standard, Level 4, which defines a peak voltage of ±4 kV.

With the IEC surge generator connected to GND₁, the ADM2795E is robust to IEC 61000-4-5 events and withstands up to ±4 kV surge. The ADM2795E withstands up to ±4 kV IEC 61000-4-5 surge without damage and with no bit errors in data communications. Testing to GND₁ demonstrates the robustness of the ADM2795E isolation barrier. Table 15 and Table 16 summarize the certified test results.

Table 15. IEC 61000-4-5 Certified Test Results

| Surge Generator Connected to | IEC 61000-4-5 Test Result | Certified Result |
|------------------------------|---------------------------|------------------|
| GND ₂ | ±4 kV Level 4 protection | Yes |
| GND ₁ | Withstands ±4 kV | Yes |

Table 16 summarizes the ADM2795E performance and classification achieved for the noted IEC system level EMC standards.

The performance corresponds to each classification as follows:

- Class A—normal operation
- Class B—temporary loss of performance (bit errors)
- Class C—system needs reset
- Class D—permanent loss of function

Table 16. Summary of Certified EMC System Level Classifications for the ADM2795E

| Test | Ground Connection | Classification | Highest Pass Level |
|---|-------------------|----------------|-------------------------------|
| IEC 61000-4-5 Surge | GND ₁ | Class A | ±4 kV |
| | GND ₂ | Class B | ±4 kV |
| IEC 61000-4-4 Electrical Fast Transient (EFT) | GND ₁ | Class B | ±2 kV |
| | GND ₂ | Class B | ±2 kV |
| IEC 61000-4-2 Electrostatic Discharge (ESD) | GND ₁ | Class B | ±8 kV (air), ±9 kV (contact) |
| | GND ₂ | Class B | ±15 kV (air), ±8 kV (contact) |
| IEC 61000-4-6 Conducted RF Immunity | GND ₁ | Class A | 10 V/m rms |
| | GND ₂ | Class A | 10 V/m rms |
| IEC 61000-4-3 Radiated RF Immunity | GND ₂ | Class A | 30 V/m |
| IEC 61000-4-8 Magnetic Immunity | GND ₂ | Class A | 100 A/m |

IEC CONDUCTED, RADIATED, AND MAGNETIC IMMUNITY

IEC 61000-4-6 Conducted RF Immunity

The IEC 61000-4-6 conducted immunity test is applicable to products that operate in environments where RF fields are present and that are connected to mains supplies or other networks (signal or control lines). The source of conducted disturbances are electromagnetic fields, emanating from RF transmitters that may act on the whole length of cables connected to installed equipment.

In the IEC 61000-4-6 test, an RF voltage is swept/stepped from 150 kHz to 80 MHz or 100 MHz. The RF voltage is amplitude modulated 80% at 1 kHz. One ADM2795E evaluation board is tested to Level 3, which is the highest test level of 10 V. For IEC 61000-4-6 testing, the stress signal is applied by using the clamp detailed in Table 17. The clamp is placed on the communications cable between two ADM2795E transceivers. For all testing, the equipment and EUT setup are as described in Table 17 and Figure 46.

Table 17 shows the test results where the EUT pass IEC 61000-4-6 to Level 3. For all of the tests, the IEC 61000-4-6 clamp is placed at the EVAL-ADM2795EEBZ EUT, and the cable shield is either floating or Earth grounded. The second EVAL-ADM2795EEBZ (auxiliary equipment) was placed on the network to terminate the communications bus. The IEC 61000-4-6 generator clamp was either connected to GND₁ or GND₂ of the ADM2795E EUT to provide a return current path for the IEC 61000-4-6 transient current.

The ADM2795E evaluation board is tested and certified to pass IEC 61000-4-6 conducted RF immunity testing to Level 3 at 10 V/m rms, in a variety of configurations as described in Table 16 and Table 17.

Table 17. IEC 61000-4-6 EUT and Equipment

| Parameter | Details |
|--------------------------|---|
| IEC 61000-4-6 Clamp | Schaffner KEMZ 801, placed at 30 cm from the EUT |
| IEC 61000-4-6 Test Level | Level 3, 0.15 MHz to 80 MHz, 10 V/m rms, 80% amplitude modulated (AM) by a 1 kHz sinusoidal |
| EUT | EVAL-ADM2795EEBZ |
| EUT Data Rate | 2.5 Mbps |
| EUT Power | 9 V battery at V _{DD1} and V _{DD2} , regulated on EUT to 5 V |
| Cable Between EUT | 5 m, Unifitronic® Profibus, 22 American wire gauge (AWG) |
| Cable Termination | 120 Ω resistor at both cable ends |
| Pass/Fail Criteria | Pass: data at receiver with a pulse width distortion within 10% of mean |

Table 18. IEC 61000-4-6 Certified Test Results

| Clamp Location from EUT (cm) | Cable Shield | Current Return Path | IEC 61000-4-6 Test Frequency (MHz) | Certified Result |
|------------------------------|--------------|---------------------|------------------------------------|------------------|
| 30 | Floating | GND ₁ | 0.15 to 80 | Pass |
| 30 | Earthed | GND ₁ | 0.15 to 80 | Pass |
| 30 | Floating | GND ₂ | 0.15 to 80 | Pass |
| 30 | Earthed | GND ₂ | 0.15 to 80 | Pass |



Figure 46. IEC 61000-4-6 Conducted RF Immunity Example Test Setup Testing to GND₁ or GND₂

14129-046

IEC 61000-4-3 Radiated RF Immunity

Testing to IEC 61000-4-3 ensures that electronic equipment is immune to commonly occurring radiated RF fields. Some commonly occurring unintentional RF emitting devices in an industrial application are electric motors and welders.

In the IEC 61000-4-3 test, a radiated RF field is generated by an antenna in a shielded anechoic chamber using a precalibrated field, swept from 80 MHz to 2.7 GHz. The RF voltage is amplitude modulated 80% at 1 kHz. Each face of the EUT is subjected to vertical and horizontal polarizations.

Figure 47 shows the test setup with the [EVAL-ADM2795EEBZ](#), the EUT, placed in an anechoic chamber, powered with two 9 V batteries. The [EVAL-ADM2795EEBZ](#) on board regulators power V_{DD1} at 5.0 V and V_{DD2} at 5.0 V. The [EVAL-ADM2795EEBZ](#) is loaded with a 120 Ω termination resistor for the duration of the test. A pattern generator provides a 2.5 Mbps data input to the [ADM2795E](#) TxD pin. The [ADM2795E](#) receiver output (Rx/D) is monitored with an oscilloscope.

The pass criteria chosen is less than a 10% change in the bit width of the Rx/D signal in the presence of the IEC 61000-4-3 radiated RF field.

The [ADM2795E](#) evaluation board is tested and certified to pass IEC 61000-4-3 radiated RF immunity testing to Level 4 (30 V/m). Level 4 is the highest level specified in the IEC 61000-4-3 standard.



Figure 47. Testing for IEC 61000-4-3 Radiated RF Immunity

14129-148

IEC 61000-4-8 Magnetic Immunity

Testing to IEC 61000-4-8 ensures that electronic equipment is immune to commonly occurring magnetic fields. The source of magnetic fields in typical industrial communication applications is power line current or 50 Hz/60 Hz transformers in close proximity to the equipment.

In the IEC 61000-4-8 test, a controlled magnetic field of defined field strength is produced by driving a large coil (induction coil) with a test current generator. The EUT is placed at the center of the induction coil, subjecting the EUT to a magnetic field.

Figure 48 shows the test setup with the [EVAL-ADM2795EEBZ](#), the EUT, placed in an anechoic chamber, powered with two 9 V batteries. The [EVAL-ADM2795EEBZ](#) on board regulators power V_{DD1} at 5.0 V and V_{DD2} at 5.0 V. The [EVAL-ADM2795EEBZ](#) is loaded with a 120 Ω termination resistor for the duration of the test. A pattern generator provides a 2.5 Mbps data input to the [ADM2795E](#) Tx/D pin. The [ADM2795E](#) receiver output (Rx/D) is monitored with an oscilloscope.

The pass criteria chosen is less than a 10% change in the bit width of the Rx/D signal in the presence of the IEC 61000-4-8 magnetic field.

The [ADM2795E](#) evaluation board is tested and certified to pass IEC 61000-4-8 magnetic immunity testing to Level 5 (100 A/m). Level 5 is the highest level specified in the IEC 61000-4-8 standard.

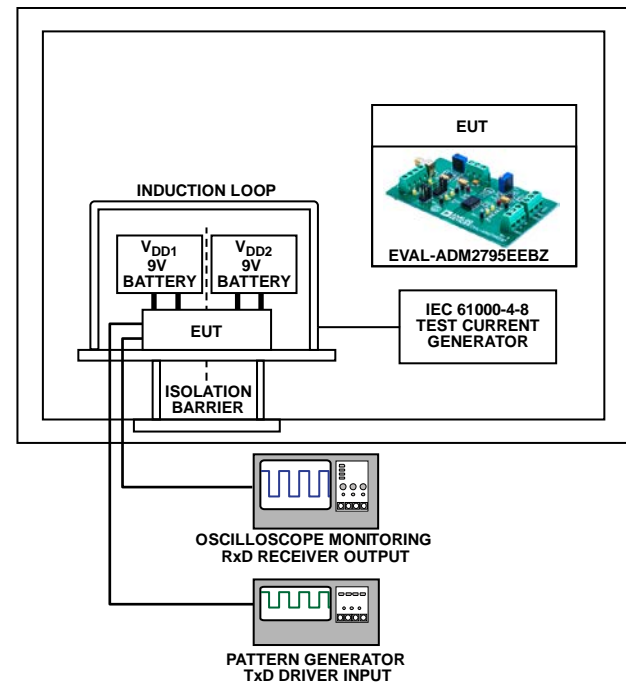

Figure 48. Testing for IEC 61000-4-8 Magnetic Immunity

14129-149

APPLICATIONS INFORMATION

RADIATED EMISSIONS AND PCB LAYOUT

The [ADM2795E](#) meets stringent electromagnetic interference (EMI) emissions targets (EN55022 Class B) with minimal PCB layout considerations. To achieve a 6 dB μ V/m margin from EN55022 Class B limits, add a 120 pF, 0603 body size capacitor on the PCB trace connected to the RxD pin and GND₁ (see Figure 49). Place the capacitor at 5 mm from the RxD pin for optimal performance. The [ADM2795E](#) evaluation board user guide provides an example PCB layout. Figure 18 shows a typical performance plot of the [ADM2795E](#) EN55022 radiated emissions profile (with a 120 pF capacitor to GND₁ on the RxD pin). The effect of adding load capacitance on the RxD pin is shown in the typical waveform rise and fall times in Figure 26.

NOISE IMMUNITY

Direct power injection (DPI) measures the ability of a component to reject noise injected onto the power supply or input pins. The [ADM2795E](#) was tested to the DPI IEC 62132-4 standard, with a high power noise source capacitively coupled into either the V_{DD1} or V_{DD2} power supply pin. The noise source was swept through a 300 kHz to 1 GHz frequency band. During DPI IEC 62132-4 testing, the [ADM2795E](#) TxD pin was clocked at 2.5 Mbps, and the clock data output on the RxD pin was monitored for errors (loopback test mode). The fail criteria was defined as greater than $\pm 10\%$ change in the bit width of the RxD signal.

Figure 50 shows a test setup, with the DPI noise source injected through a 6.8 nF capacitor on the [ADM2795E](#) V_{DD1} power supply pin. Figure 22 to Figure 24 in the Typical Performance Characteristics section show the fail point for the [ADM2795E](#) across the noise power (dBm) vs. DPI frequency (Hz). Figure 21 shows that the addition of a 10 μ F decoupling capacitor, in addition to the standard 100 nF decoupling capacitor, improves low frequency noise immunity.

Performance to the IEC 62132-4 standard was evaluated for the [ADM2795E](#) and compared to other isolators/transceivers available in the market. The [ADM2795E](#) noise immunity performance exceeds that of other similar products. The [ADM2795E](#) maintains excellent performance over frequency, but other isolation products exhibit bit errors in the 200 MHz to 700 MHz frequency band.

FULLY RS-485 COMPLIANT OVER AN EXTENDED ± 25 V COMMON-MODE VOLTAGE RANGE

The [ADM2795E](#) is an RS-485 transceiver that offers an extended common-mode input range of ± 25 V across an operating voltage range of 3 V to 5.5 V, while still meeting or exceeding compliance with TIA/EIA RS-485/RS-422 standards. The TIA/EIA RS-485/RS-422 standards specify a bus differential voltage of at least 1.5 V across the common-mode voltage range. In addition, when powered at greater than 4.5 V V_{DD2}, the [ADM2795E](#) driver output is a minimum 2.1 V |V_{OD}|, meeting the requirements for a Profibus compliant RS-485 driver. The extended common-mode input voltage range of ± 25 V improves system robustness over long cable lengths, where large differences in ground potential between RS-485 transceivers are possible. The extended common-mode input voltage range of ± 25 V improves data communication reliability in noisy environments over long cable lengths where ground loop voltages are possible.

1.7 V TO 5.5 V V_{DD1} LOGIC SUPPLY

The [ADM2795E](#) features a logic supply pin, V_{DD1}, for flexible digital interface operational to voltages as low as 1.7 V. The V_{DD1} pin powers the logic inputs (TxD input, and DE and $\overline{\text{RE}}$ control pins) and the RxD output. These pins interface with logic devices such as universal asynchronous receiver/transmitters (UARTs), application specific integrated circuits (ASICs), and microcontrollers. Many of these devices use power supplies significantly lower than 5 V.

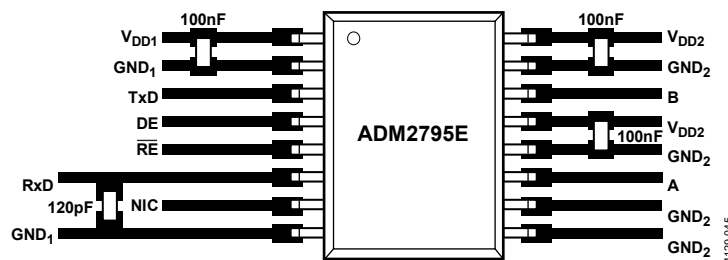
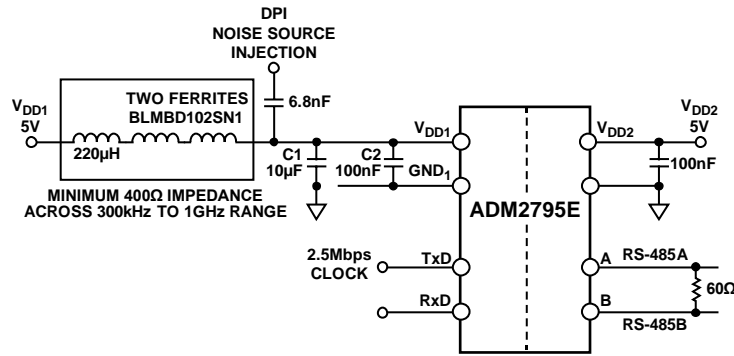

Figure 49. Recommended PCB Layout to Meet EN55022 Class B Radiated Emissions



NOTES
1. SIMPLIFIED DIAGRAM, ALL PINS NOT SHOWN.

Figure 50. Typical Setup for DPI IEC 62132-4 Noise Immunity Test

TRUTH TABLES

Table 20 and Table 21 use the abbreviations shown in Table 19. V_{DD1} supplies the DE, TxD, RE, and RxD pins only.

Table 19. Truth Table Abbreviations

| Letter | Description |
|--------|----------------------|
| H | High level |
| I | Indeterminate |
| L | Low level |
| X | Any state |
| Z | High impedance (off) |
| NC | Disconnected |

Table 20. Transmitting Truth Table

| Supply Status | | Inputs | | Outputs | |
|------------------|------------------|--------|-----|---------|---|
| V _{DD2} | V _{DD1} | DE | TxD | A | B |
| On | On | H | H | H | L |
| On | On | H | L | L | H |
| On | On | L | X | Z | Z |
| On | Off | H | H | I | I |
| On | Off | H | L | I | I |
| On | Off | L | X | I | I |
| Off | On | X | X | Z | Z |
| Off | Off | X | X | Z | Z |

Table 21. Receiving Truth Table

| Supply Status | | Inputs | RE | Outputs |
|------------------|------------------|--------------------------|---------|---------|
| V _{DD2} | V _{DD1} | A – B | RE | RxD |
| On | On | >–0.03 V | L | H |
| On | On | <–0.2 V | L | L |
| On | Off | >–0.03 V | L | I |
| On | Off | <–0.2 V | L | I |
| On | On | –0.2 V < A – B < –0.03 V | L | I |
| On | Off | –0.2 V < A – B < –0.03 V | L | I |
| On | On | Inputs open/shorted | L | H |
| On | Off | Inputs open/shorted | L | I |
| On | On | X | H | Z |
| On | Off | X | H | I |
| Off | Off | X | H | I |
| Off | Off | X | L or NC | I |

RECEIVER FAIL-SAFE

The receiver input includes a fail-safe feature that guarantees a logic high RxD output when the A and B inputs are floating, open circuit, or short circuit. A logic high RxD output is guaranteed in a terminated transmission line with all drivers disabled. This fail-safe RxD guaranteed output logic high is implemented by setting the receiver input threshold between –30 mV and –200 mV. If the differential receiver input voltage (A – B) is greater than or equal to –30 mV, RxD is logic high. If A – B is less than or equal to –200 mV, RxD is logic low. In the case of a terminated bus with all transmitters disabled, the receiver differential input voltage is pulled to 0 V by the termination. With the receiver thresholds of the ADM2795E, this results in a RxD output logic high with a 30 mV minimum noise margin.

RS-485 DATA RATE AND BUS CAPACITANCE

The data rate and bus node capability of the ADM2795E are dependent on the operating temperature of the device. As the operating temperature of the ADM2795E is increased, the capacitance of the ADM2795E integrated EMC protection circuitry is also increased. The driver output structures of the ADM2795E can be simplified as low-pass filter structures, with a given resistance and capacitance. As the operating temperature increases, the capacitance increases. The low-pass filter effectively works to decrease the maximum data rate that can be driven on the RS-485 bus pins.

INSULATION WEAR OUT

The lifetime of insulation caused by wear out is determined by its thickness, material properties, and the voltage stress applied. It is important to verify that the product lifetime is adequate at the application working voltage. The working voltage supported by an isolator for wear out may not be the same as the working voltage supported for tracking. The working voltage applicable to tracking is specified in most standards.

Testing and modeling show that the primary driver of long-term degradation is displacement current in the polyimide insulation causing incremental damage. The stress on the insulation can be broken down into broad categories, such as dc stress, which causes very little wear out because there is no

displacement current, and an ac component time varying voltage stress, which causes wear out.

The ratings in certification documents are typically based on 60 Hz sinusoidal stress because this reflects isolation from the line voltage. However, many practical applications have combinations of 60 Hz ac and dc across the barrier as shown in Equation 1. Because only the ac portion of the stress causes wear out, the equation can be rearranged to solve for the ac rms voltage, as shown in Equation 2. For insulation wear out with the polyimide materials used in the [ADM2795E](#), the ac rms voltage determines the product lifetime.

$$V_{RMS} = \sqrt{V_{AC\ RMS}^2 + V_{DC}^2} \tag{1}$$

or

$$V_{AC\ RMS} = \sqrt{V_{RMS}^2 - V_{DC}^2} \tag{2}$$

where:

V_{RMS} is the total rms working voltage.

$V_{AC\ RMS}$ is the time varying portion of the working voltage.

V_{DC} is the dc offset of the working voltage.

Calculation and Use of Parameters Example

The following example frequently arises in power conversion applications. Assume that the line voltage on one side of the isolation is 240 V ac rms and a 400 V dc bus voltage is present on the other side of the isolation barrier. The isolator material is polyimide. To establish the critical voltages in determining the creepage, clearance, and lifetime of a device, see Figure 51 and the following equations.



Figure 51. Critical Voltage Example

The working voltage across the barrier from Equation 1 is

$$V_{RMS} = \sqrt{V_{AC\ RMS}^2 + V_{DC}^2}$$

$$V_{RMS} = \sqrt{240^2 + 400^2}$$

$$V_{RMS} = 466\ V$$

This V_{RMS} value is the working voltage used together with the material group and pollution degree when looking up the creepage required by a system standard.

To determine if the lifetime is adequate, obtain the time varying portion of the working voltage. To obtain the ac rms voltage, use Equation 2.

$$V_{AC\ RMS} = \sqrt{V_{RMS}^2 - V_{DC}^2}$$

$$V_{AC\ RMS} = \sqrt{466^2 - 400^2}$$

$$V_{AC\ RMS} = 240\ V\ rms$$

In this case, the ac rms voltage is simply the line voltage of 240 V rms. This calculation is more relevant when the waveform is not sinusoidal. The value is compared to the limits for working voltage in Table 8 for the expected lifetime, less than a 60 Hz sine wave, and it is well within the limit for a 50-year service life.

Note that the dc working voltage limit in Table 8 is set by the creepage of the package as specified in IEC 60664-1. This value can differ for specific system level standards.

HOT SWAP CAPABILITY

When a PCB is inserted into a hot (or powered) backplane, differential disturbances to the data bus can lead to data errors. The [ADM2795E](#) was lab tested to ensure that the RS-485 A and B bus pins did not output spurious data during a power-up/power-down event, which simulated a PCB hot insertion. The power supply ramp test rates were 0 V to 5 V in 300 μs (fast ramp rate), and 0 V to 5 V in 9.5 ms (slow ramp rate). For these ramp rates, the RS-485 A and B outputs were monitored and with no output glitches were observed.

ROBUST HALF-DUPLEX RS-485 NETWORK

Figure 52 shows a robust isolated RS-485 communications network, with bus communications running over 1000 feet of cabling. Over long cable runs with multiple RS-485 nodes, a number of hazards can either corrupt data communication or even cause permanent damage to the RS-485 interface. The [ADM2795E](#) provides robust protection against high voltage faults to bus power supplies and EMC transients, such as an IEC 61000-4-5 surge. In addition, the [ADM2795E](#) has an extended common-mode input range of ±25 V, which allows ±25 V of ground potential difference between the isolated GND₂ pins of two or more [ADM2795E](#) devices.



Figure 52. Robust Half-Duplex Isolated RS-485 Communication Network

14125-048

EMC COMPLIANT AND FAULT PROTECTED SIGNAL AND POWER ISOLATED RS-485 NODE

The circuit shown in Figure 53 demonstrates a fully isolated RS-485 node using the ADM2795E and the ADuM6028 isolated dc to dc converter. The small form factor and low radiated emissions of the ADuM6028 make the combination of the two devices ideal for space constrained applications that require high voltage ± 42 V fault protection on the bus pins as well as integrated Level 4 EMC protection to IEC standards against ESD, EFT, and surge.

The ADuM6028 can deliver a minimum of 60 mA of current at the 3.3 V output supply in a compact 5.85 mm \times 10.31 mm low profile footprint. When the ADM2795E is fully loaded and switching at 2.5 Mbps, the device consumes up to 50 mA at 3.3 V, which can be supplied from the ADuM6028.

The ADuM6028 can be powered from either a 3.3 V or 5 V supply, depending on the selected model. The V_{DD1} pin of the ADM2795E can be powered from the same rail as the isolated dc to dc converter, or the device can alternatively be connected to the low voltage supply rail of a microcontroller or logic device that operates with an input supply voltage between 1.7 V and 5.5 V.

In applications where 5 kV of isolation is not required, the ADuM5028 can be used in place of the ADuM6028. See Table 22 for device selection and the maximum allowed ambient temperature.

Two surface-mount ferrite beads are used to meet EN 55022 Class B radiated emissions requirements on a standard 2-layer PCB. See the ADuM6028 data sheet for implementation details.

In applications where a 5 V V_{DD2} supply voltage is preferred on the ADM2795E, users can replace the ADuM6028 with the ADuM6020, which can provide the necessary 100 mA for up to 105°C operation in a compact 16-lead wide body SOIC package.

Table 22. Isolated DC to DC Converter Selection Table

| Isolation Rating (kV) | V _{DDP} Supply Voltage (V) | Maximum Operating Temperature (°C) | Isolated DC to DC Converter |
|-----------------------|-------------------------------------|------------------------------------|-----------------------------|
| 5 | 5 | 85 | ADuM6028-5BRIZ |
| 5 | 3.3 | 105 | ADuM6028-3BRIZ |
| 2.5 | 5 | 85 | ADuM5028-5BRIZ |
| 2.5 | 3.3 | 105 | ADuM5028-3BRIZ |



Figure 53. 2.5 Mbps, 5 kV Signal and Power Isolated RS-485 Node with ± 42 V Fault Protection and Level 4 EMC Protection (3.3 V Transceiver)

OUTLINE DIMENSIONS



COMPLIANT TO JEDEC STANDARDS MS-013-AA
 CONTROLLING DIMENSIONS ARE IN MILLIMETERS; INCH DIMENSIONS
 (IN PARENTHESES) ARE ROUNDED-OFF MILLIMETER EQUIVALENTS FOR
 REFERENCE ONLY AND ARE NOT APPROPRIATE FOR USE IN DESIGN.

03-27-2007-B

Figure 54. 16-Lead Standard Small Outline Package [SOIC_W]
 Wide Body
 (RW-16)
 Dimensions shown in millimeters and (inches)

ORDERING GUIDE

| Model ¹ | Temperature Range | Package Description | Package Option | Ordering Quantity |
|--------------------|-------------------|--|----------------|-------------------|
| ADM2795EBRWZ | -40°C to +125°C | 16-Lead Standard Small Outline Package [SOIC_W] | RW-16 | |
| ADM2795EBRWZ-RL7 | -40°C to +125°C | 16-Lead Standard Small Outline Package [SOIC_W], 7" Reel | RW-16 | 400 |
| ADM2795EARWZ | -40°C to +85°C | 16-Lead Standard Small Outline Package [SOIC_W] | RW-16 | |
| ADM2795EARWZ-RL7 | -40°C to +85°C | 16-Lead Standard Small Outline Package [SOIC_W], 7" Reel | RW-16 | 400 |
| EVAL-ADM2795EEBZ | | Evaluation Board | | |

¹ Z = RoHS Compliant Part.