

Chip Beads(SMD Array) For General Signal Line

Conformity to RoHS Directive

MZA Series MZA2010 Type

FEATURES

- A single MZA series chip provides noise attenuation for four lines, making it ideal for use with I/O lines of various highly miniaturized.
- Electronic equipment, such as portable products, which comprise high density circuitry.
- Low crosstalk between adjacent circuits.
- Internal electrodes feature low DC resistance, minimizing wasteful power consumption.
- Electroplated terminal electrodes accommodate reflow soldering.
- Monolithic structure ensures high reliability.
- It is a product conforming to RoHS directive.

APPLICATIONS

High-frequency noise countermeasure in computers, printers, VCRs, televisions, portable telephones, and other equipment.

PRODUCT IDENTIFICATION

MZA	2010	D	121	C	T
(1)	(2)	(3)	(4)	(5)	(6)

- (1) Series name
- (2) Dimensions L×W
- (3) Material code
- (4) Nominal impedance
121:120Ω at 100MHz
- (5) Characteristic type
- (6) Packaging style
T:Taping

HANDLING AND PRECAUTIONS

- Before soldering, be sure to preheat components. The preheating temperature should be set so that the temperature difference between the solder temperature and product temperature does not exceed 150°C.
- After mounting components onto the printed circuit board, do not apply stress through board bending or mishandling.
- Do not expose the inductors to stray magnetic fields.
- Avoid static electricity discharge during handling.
- When hand soldering, apply the soldering iron to the printed circuit board only. Temperature of the iron tip should not exceed 350°C. Soldering time should not exceed 3 seconds.
- This product does not apply to flow soldering construction method.

MATERIAL CHARACTERISTICS

B material: This type is perfectly suited for fast digital signals. By equalizing R components and X components that beads possess at a frequency of 5MHz, it is able to suppress overshooting, undershooting and ringing of fast digital signals.

S material: Standard type that features impedance characteristics similar to those of a typical ferrite core. For signal line applications in which the blocking region is near 100MHz. Impedance values selected for effectiveness at 40 to 300MHz.

Y material: High frequency range type intended for the 100MHz region and above. For signal line applications in which the signal frequency is far from the cutoff frequency. Impedance values selected for effectiveness at 80 to 400MHz.

D material: For applications calling for low insertion loss at low frequencies and sharply increasing impedance at high frequencies. Designed for high impedance at high frequencies (300MHz to 1GHz) for signal line applications.

F material: This new product inherits the characteristic of our D-material, namely its sharp impedance rise time, and its impedance peak frequency has been shifted higher into range. The product offers excellent noise suppression from 600MHz to as high as in the GHz range.

TYPICAL MATERIAL CHARACTERISTICS

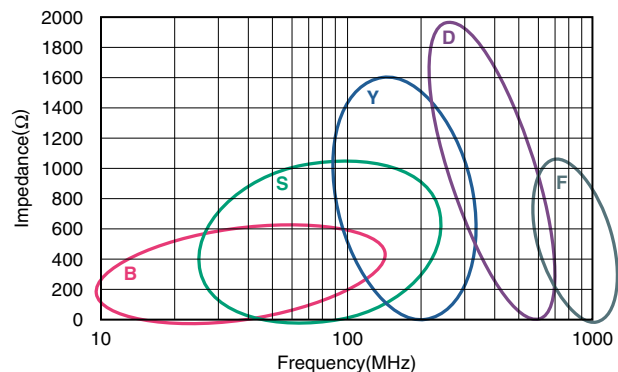

• Conformity to RoHS Directive: This means that, in conformity with EU Directive 2002/95/EC, lead, cadmium, mercury, hexavalent chromium, and specific bromine-based flame retardants, PBB and PBDE, have not been used, except for exempted applications.

• Please contact our Sales office when your application are considered the following:
The device's failure or malfunction may directly endanger human life (e.g. application for automobile/aircraft/medical/nuclear power devices, etc.)

• All specifications are subject to change without notice.

SHAPES AND DIMENSIONS/RECOMMENDED PC BOARD PATTERN

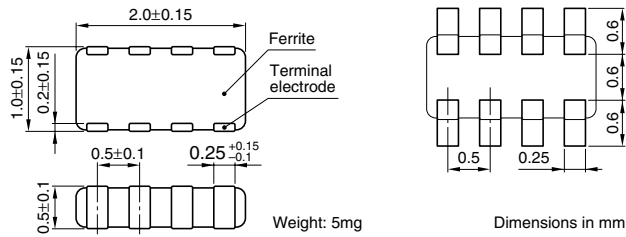

CIRCUIT DIAGRAM

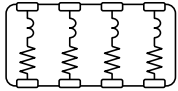

• No polarity

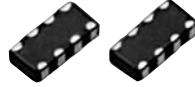

RECOMMENDED SOLDERING CONDITION REFLOW SOLDERING

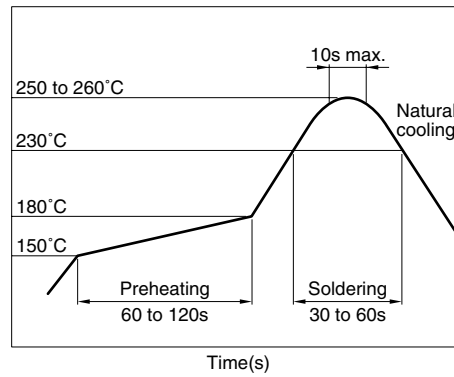

TEMPERATURE RANGES

Operating/storage -55 to +125°C

PACKAGING STYLE AND QUANTITIES

Packaging style Quantity
Taping 5000 pieces/reel

ELECTRICAL CHARACTERISTICS

Part No.	Impedance (Ω)[100MHz]*	DC resistance (Ω)max.	Rated current (mA)max.	Rated voltage (V)max.
MZA2010B241C	240±25%	0.45	100	5
MZA2010S800C	80±25%	0.22	100	5
MZA2010S121C	120±25%	0.25	100	5
MZA2010S241C	240±25%	0.35	100	5
MZA2010S601C	600±25%	0.5	100	5
MZA2010S102C	1000±25%	0.75	100	5
MZA2010Y800C	80±25%	0.3	100	5
MZA2010Y121C	120±25%	0.4	100	5
MZA2010Y241C	240±25%	0.6	100	5
MZA2010Y601C	600±25%	0.8	100	5
MZA2010Y102C	1000±25%	1.0	100	5
MZA2010D330C	33±25%	0.3	50	5
MZA2010D680C	68±25%	0.5	50	5
MZA2010D121C	120±25%	0.8	50	5
MZA2010D241C	240±25%	1.2	50	5
MZA2010F330C	33±25%	0.6	100	5
MZA2010F470C	47±25%	0.8	100	5
MZA2010F560C	56±25%	0.8	100	5

* Test equipment: E4991A or equivalent

Test tool: 16192A or equivalent

Test temperature: 25±10°C

TYPICAL ELECTRICAL CHARACTERISTICS

Z, X, R vs. FREQUENCY CHARACTERISTICS

MZA2010B241C

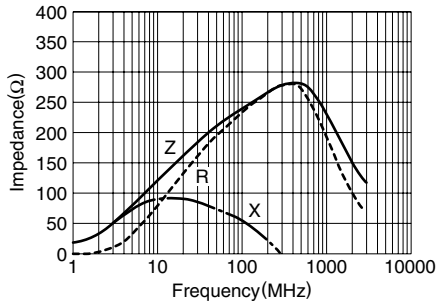

MZA2010S800C

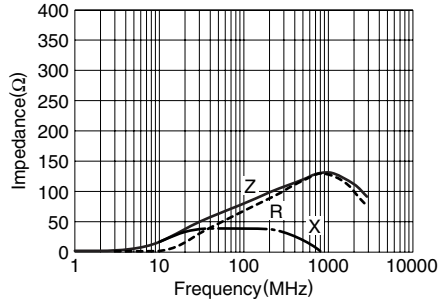

MZA2010S121C

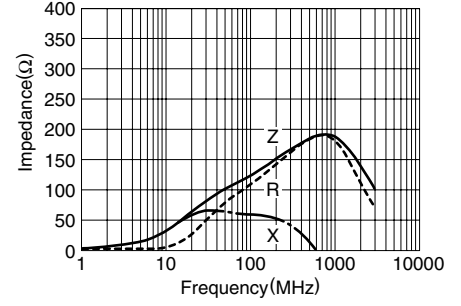

MZA2010S241C

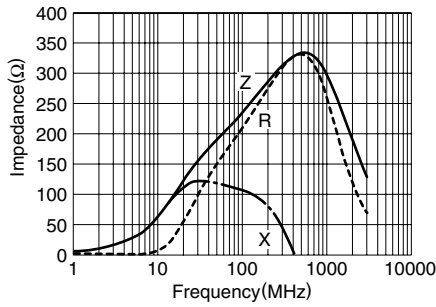

MZA2010S601C

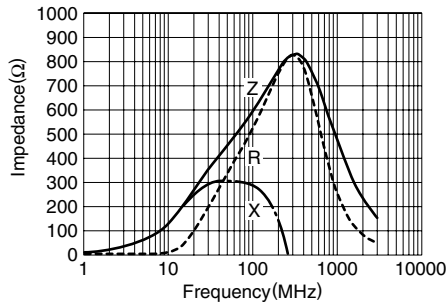

MZA2010S102C

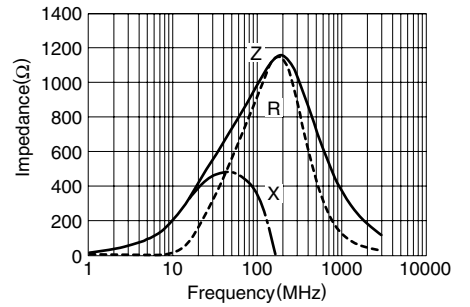

MZA2010Y800C

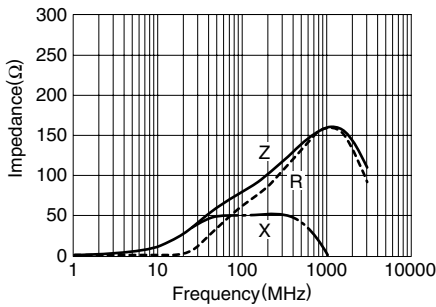

MZA2010Y121C

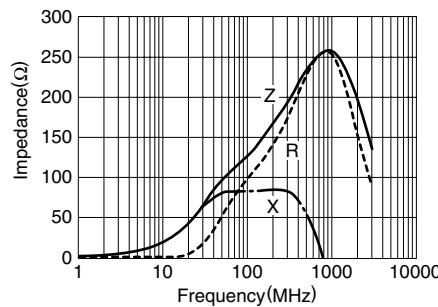

MZA2010Y241C

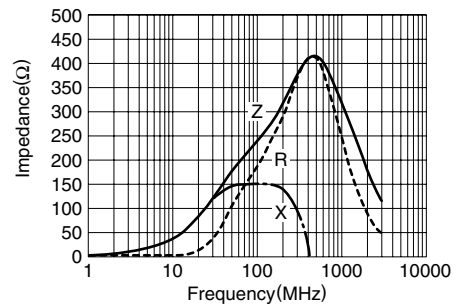

MZA2010Y601C

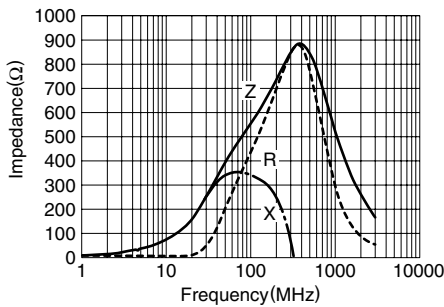

MZA2010Y102C

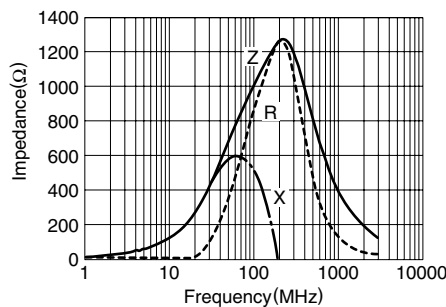

MZA2010D330C

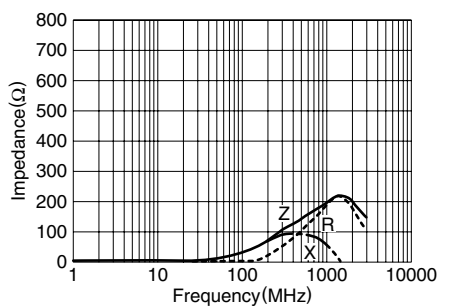

• All specifications are subject to change without notice.

TYPICAL ELECTRICAL CHARACTERISTICS

Z, X, R vs. FREQUENCY CHARACTERISTICS

MZA2010D680C

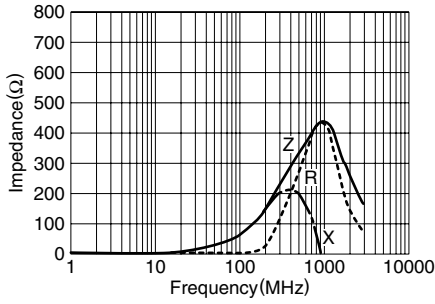

MZA2010D121C

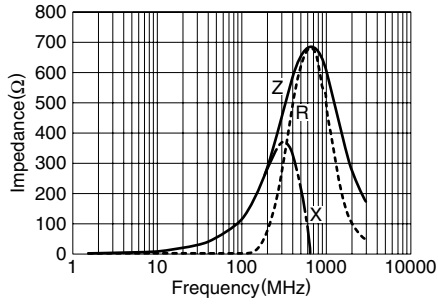

MZA2010D241C

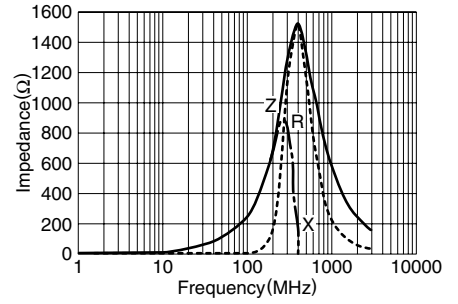

MZA2010F330C

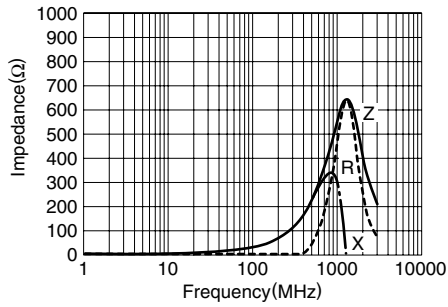

MZA2010F470C

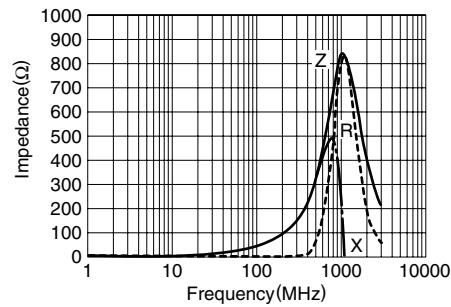

MZA2010F560C

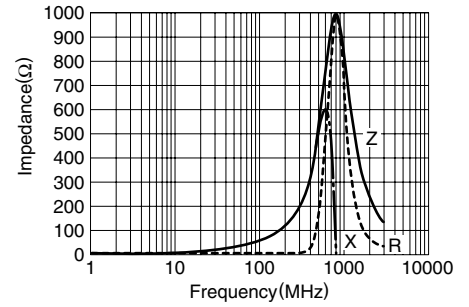

PACKAGING STYLES

REEL DIMENSIONS

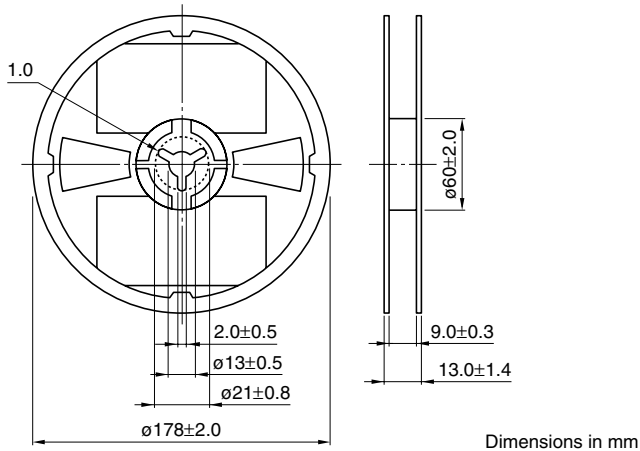

Dimensions in mm

TAPE DIMENSIONS

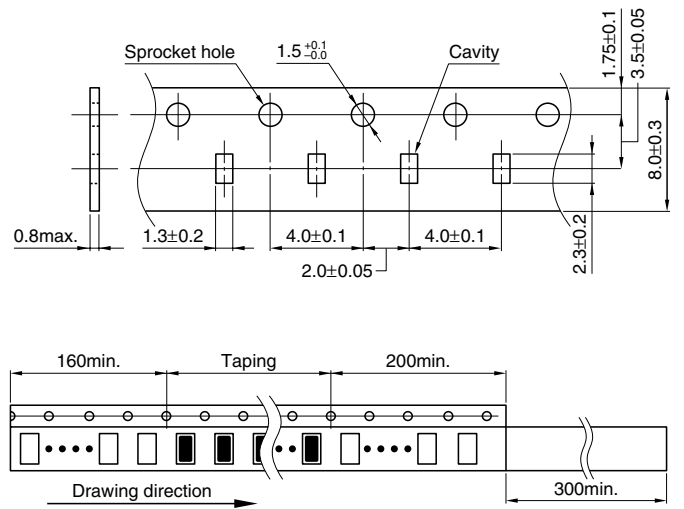

Dimensions in mm

• All specifications are subject to change without notice.