

Standard Recovery Diodes (Stud Version), 12 A



DO-203AA (DO-4)

FEATURES

- High surge current capability
- Stud cathode and stud anode version
- Wide current range
- Types up to 1200 V V_{RRM}
- RoHS compliant
- Designed and qualified for industrial and consumer level

RoHS
COMPLIANT

TYPICAL APPLICATIONS

- Battery charges
- Converters
- Power supplies
- Machine tool controls

PRODUCT SUMMARY

$I_{F(AV)}$	12 A
-------------	------

MAJOR RATINGS AND CHARACTERISTICS

PARAMETER	TEST CONDITIONS	VALUES	UNITS
$I_{F(AV)}$		12	A
	T_C	144	°C
$I_{F(RMS)}$		19	A
I_{FSM}	50 Hz	265	A
	60 Hz	280	
I^2t	50 Hz	351	A ² s
	60 Hz	320	
V_{RRM}	Range	100 to 1200	V
T_J		- 65 to 175	°C

ELECTRICAL SPECIFICATIONS

VOLTAGE RATINGS

TYPE NUMBER	VOLTAGE CODE	V_{RRM} , MAXIMUM REPETITIVE PEAK REVERSE VOLTAGE V	V_{RSM} , MAXIMUM NON-REPETITIVE PEAK VOLTAGE V	$V_{R(BR)}$, MINIMUM AVALANCHE VOLTAGE V ⁽¹⁾	I_{RRM} MAXIMUM AT $T_J = 175$ °C mA
12F(R)	10	100	150	-	12
	20	200	275	-	
	40	400	500	500	
	60	600	725	750	
	80	800	950	950	
	100	1000	1200	1150	
	120	1200	1400	1350	

Note

⁽¹⁾ Avalanche version only available from V_{RRM} 400 V to 1200 V



FORWARD CONDUCTION					
PARAMETER	SYMBOL	TEST CONDITIONS		VALUES	UNITS
Maximum average forward current at case temperature	$I_{F(AV)}$	180° conduction, half sine wave		12	A
				144	°C
Maximum RMS forward current	$I_{F(RMS)}$			19	A
Maximum on-repetitive peak reverse power	$P_R^{(1)}$	10 μ s square pulse, $T_J = T_J$ maximum		7	K/W
Maximum peak, one-cycle forward, non-repetitive surge current	I_{FSM}	t = 10 ms	No voltage reappplied	Sinusoidal half wave, initial $T_J = T_J$ maximum	A
		t = 8.3 ms			
		t = 10 ms	100 % V_{RRM} reappplied		
		t = 8.3 ms			
Maximum I^2t for fusing	I^2t	t = 10 ms	No voltage reappplied		A ² s
		t = 8.3 ms			
		t = 10 ms	100 % V_{RRM} reappplied		
		t = 8.3 ms			
Maximum $I^2\sqrt{t}$ for fusing	$I^2\sqrt{t}$	t = 0.1 to 10 ms, no voltage reappplied		3510	A ² \sqrt{s}
Low level value of threshold voltage	$V_{F(TO)1}$	$(16.7\% \times \pi \times I_{F(AV)}) < I < \pi \times I_{F(AV)}$, $T_J = T_J$ maximum		0.77	V
High level value of threshold voltage	$V_{F(TO)2}$	$I > \pi \times I_{F(AV)}$, $T_J = T_J$ maximum		0.97	
Low level value of forward slope resistance	r_{f1}	$(16.7\% \times \pi \times I_{F(AV)}) < I < \pi \times I_{F(AV)}$, $T_J = T_J$ maximum		10.70	m Ω
High level value of forward slope resistance	r_{f2}	$I > \pi \times I_{F(AV)}$, $T_J = T_J$ maximum		6.20	
Maximum forward voltage drop	V_{FM}	$I_{pk} = 38$ A, $T_J = 25$ °C, $t_p = 400$ μ s rectangular wave		1.26	V

Note

(1) Available only for avalanche version, all other parameters the same as 12F

THERMAL AND MECHANICAL SPECIFICATIONS					
PARAMETER	SYMBOL	TEST CONDITIONS		VALUES	UNITS
Maximum junction operating temperature range	T_J			- 65 to 175	°C
Maximum storage temperature range	T_{Stg}			- 65 to 200	
Maximum thermal resistance, junction to case	R_{thJC}	DC operation		2	K/W
Maximum thermal resistance, case to heatsink	R_{thCS}	Mounting surface, smooth, flat and greased		0.5	
Allowable mounting torque		Not lubricated threads		1.5 + 0 - 10 %	N · m
				13	lbf · in
		Lubricated threads		1.2 + 0 - 10 %	N · m
				10	lbf · in
Approximate weight				7	g
				0.25	oz.
Case style		See dimensions - link at the end of datasheet		DO-203AA (DO-4)	



ΔR_{thJC} CONDUCTION				
CONDUCTION ANGLE	SINUSOIDAL CONDUCTION	RECTANGULAR CONDUCTION	TEST CONDITIONS	UNITS
180°	0.33	0.26	T _J = T _J maximum	K/W
120°	0.41	0.44		
90°	0.53	0.58		
60°	0.78	0.81		
30°	1.28	1.29		

Note

- The table above shows the increment of thermal resistance R_{thJC} when devices operate at different conduction angles than DC

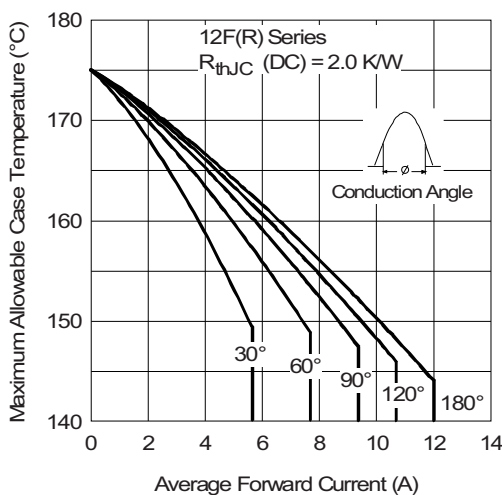

Fig. 1 - Current Ratings Characteristics

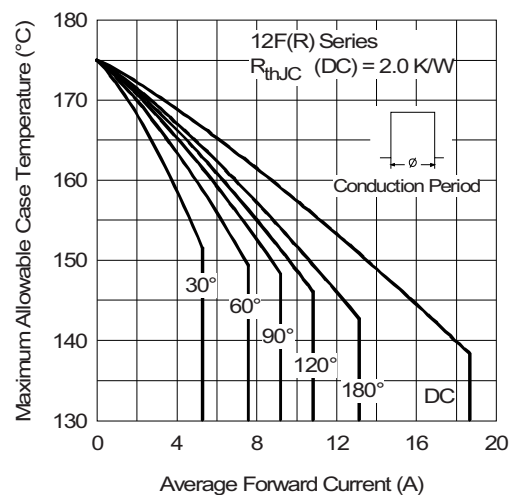

Fig. 2 - Current Ratings Characteristics

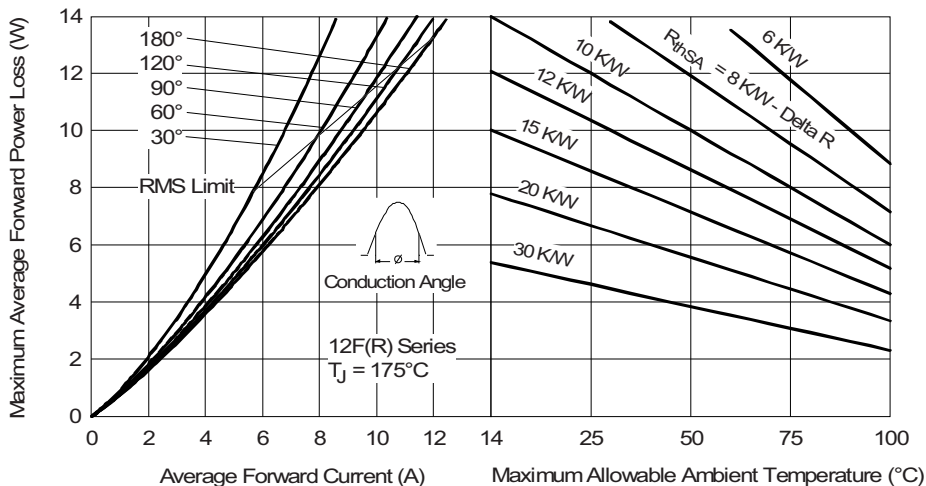

Fig. 3 - Forward Power Loss Characteristics

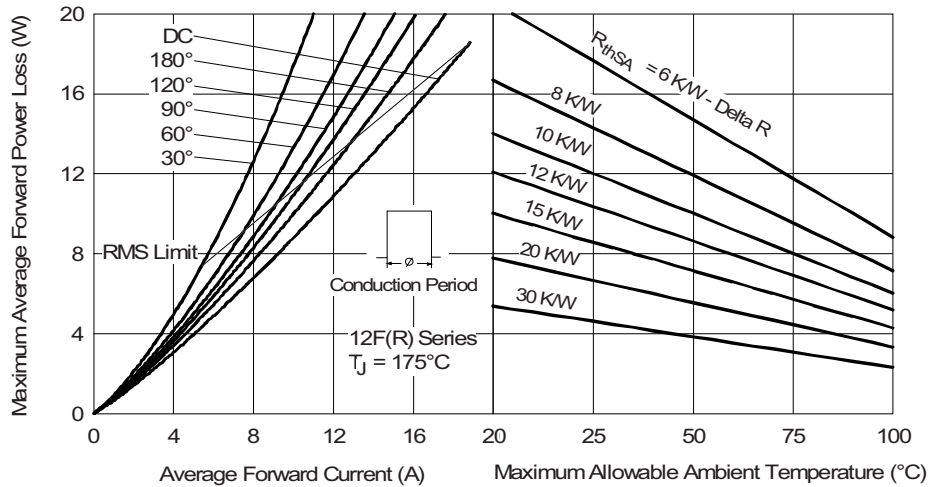

Fig. 4 - Forward Power Loss Characteristics

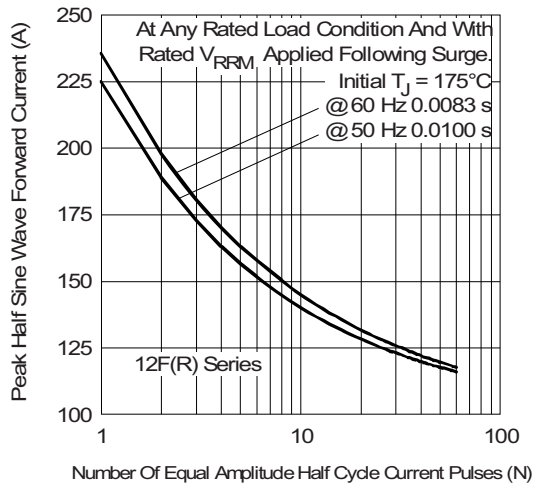

Fig. 5 - Maximum Non-Repetitive Surge Current

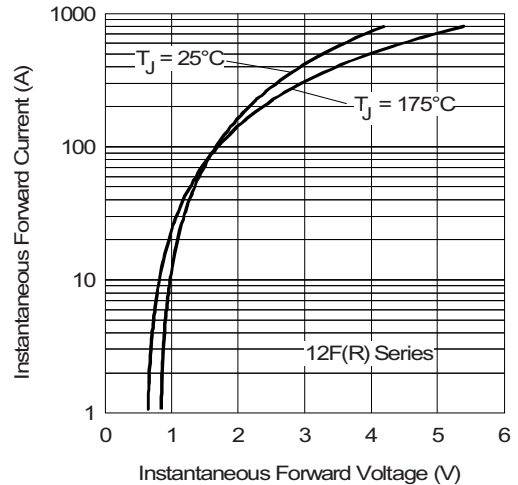

Fig. 7 - Forward Voltage Drop Characteristics

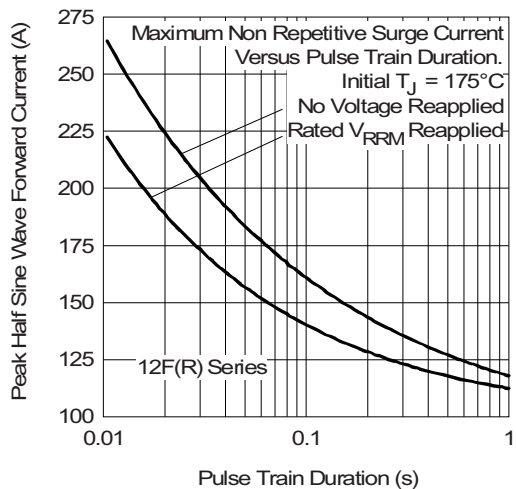

Fig. 6 - Maximum Non-Repetitive Surge Current

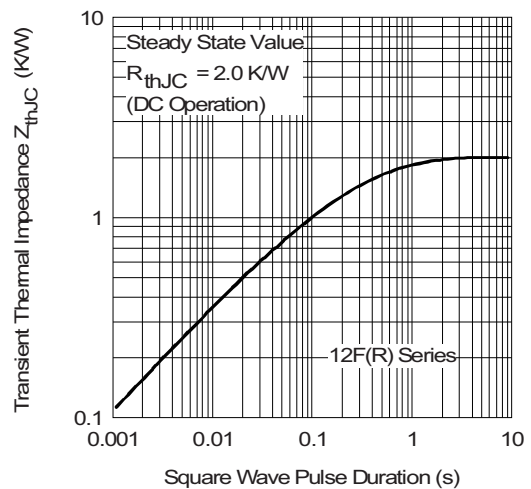
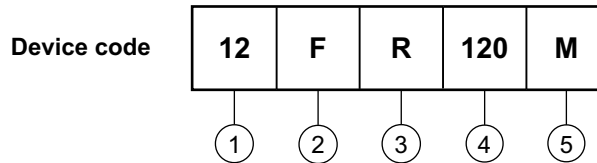

Fig. 8 - Thermal Impedance Z_{thJC} Characteristics



ORDERING INFORMATION TABLE



- 1** - Current rating: Code = $I_{F(AV)}$
- 2** - F = Standard device
- 3** - None = Stud normal polarity (cathode to stud)
R = Stud reverse polarity (anode to stud)
- 4** - Voltage code x 10 = V_{RRM} (see Voltage Ratings table)
- 5** - None = Stud base DO-203AA (DO-4) 10-32UNF-2A
M = Stud base DO-203AA (DO-4) M5 x 0.8
(not available for avalanche diodes)

LINKS TO RELATED DOCUMENTS	
Dimensions	http://www.vishay.com/doc?95311

DO-203AA (DO-4)

DIMENSIONS in millimeters (inches)

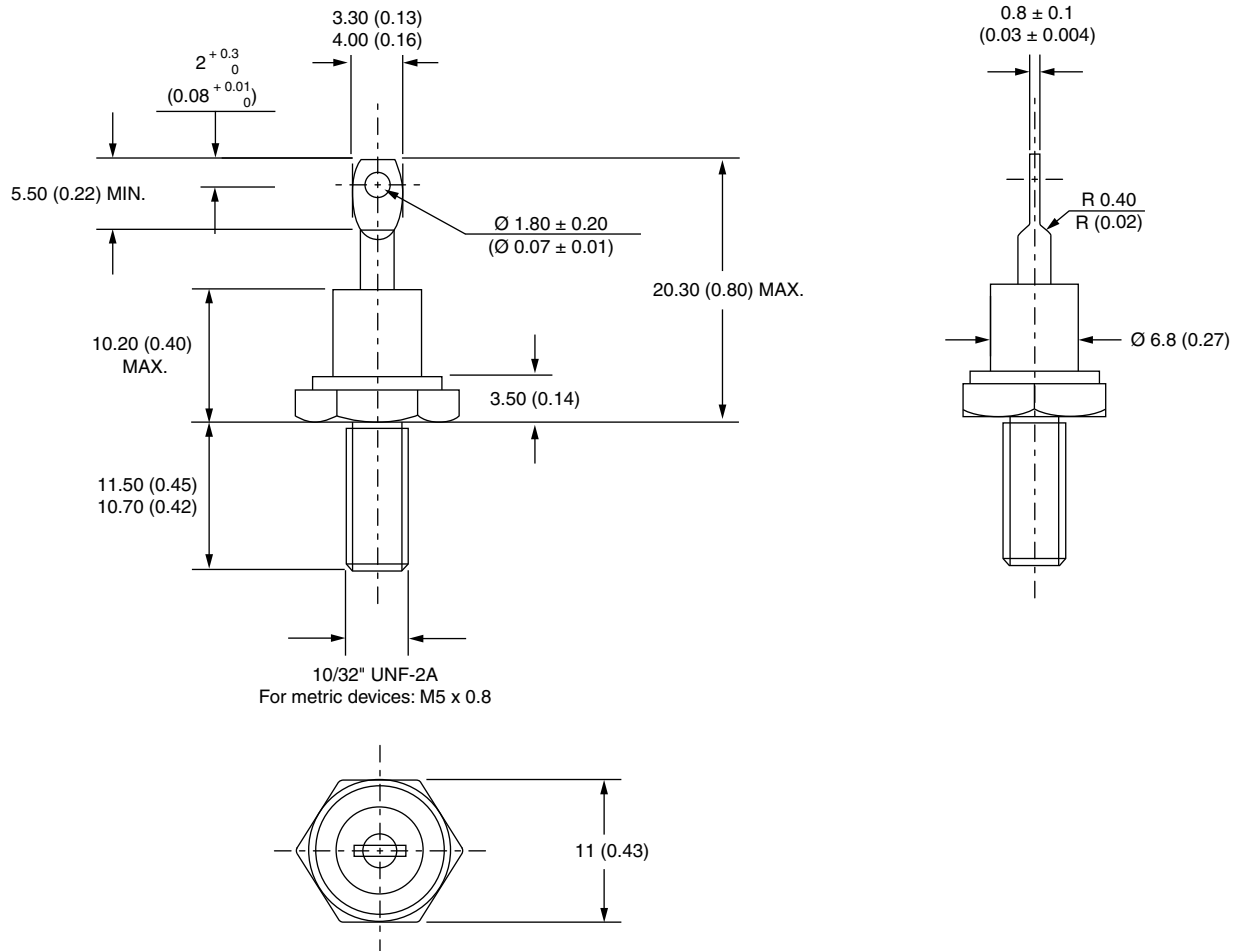



Disclaimer

ALL PRODUCT, PRODUCT SPECIFICATIONS AND DATA ARE SUBJECT TO CHANGE WITHOUT NOTICE TO IMPROVE RELIABILITY, FUNCTION OR DESIGN OR OTHERWISE.

Vishay Intertechnology, Inc., its affiliates, agents, and employees, and all persons acting on its or their behalf (collectively, "Vishay"), disclaim any and all liability for any errors, inaccuracies or incompleteness contained in any datasheet or in any other disclosure relating to any product.

Vishay makes no warranty, representation or guarantee regarding the suitability of the products for any particular purpose or the continuing production of any product. To the maximum extent permitted by applicable law, Vishay disclaims (i) any and all liability arising out of the application or use of any product, (ii) any and all liability, including without limitation special, consequential or incidental damages, and (iii) any and all implied warranties, including warranties of fitness for particular purpose, non-infringement and merchantability.

Statements regarding the suitability of products for certain types of applications are based on Vishay's knowledge of typical requirements that are often placed on Vishay products in generic applications. Such statements are not binding statements about the suitability of products for a particular application. It is the customer's responsibility to validate that a particular product with the properties described in the product specification is suitable for use in a particular application. Parameters provided in datasheets and/or specifications may vary in different applications and performance may vary over time. All operating parameters, including typical parameters, must be validated for each customer application by the customer's technical experts. Product specifications do not expand or otherwise modify Vishay's terms and conditions of purchase, including but not limited to the warranty expressed therein.

Except as expressly indicated in writing, Vishay products are not designed for use in medical, life-saving, or life-sustaining applications or for any other application in which the failure of the Vishay product could result in personal injury or death. Customers using or selling Vishay products not expressly indicated for use in such applications do so at their own risk. Please contact authorized Vishay personnel to obtain written terms and conditions regarding products designed for such applications.

No license, express or implied, by estoppel or otherwise, to any intellectual property rights is granted by this document or by any conduct of Vishay. Product names and markings noted herein may be trademarks of their respective owners.

Material Category Policy

Vishay Intertechnology, Inc. hereby certifies that all its products that are identified as RoHS-Compliant fulfill the definitions and restrictions defined under Directive 2011/65/EU of The European Parliament and of the Council of June 8, 2011 on the restriction of the use of certain hazardous substances in electrical and electronic equipment (EEE) - recast, unless otherwise specified as non-compliant.

Please note that some Vishay documentation may still make reference to RoHS Directive 2002/95/EC. We confirm that all the products identified as being compliant to Directive 2002/95/EC conform to Directive 2011/65/EU.

Vishay Intertechnology, Inc. hereby certifies that all its products that are identified as Halogen-Free follow Halogen-Free requirements as per JEDEC JS709A standards. Please note that some Vishay documentation may still make reference to the IEC 61249-2-21 definition. We confirm that all the products identified as being compliant to IEC 61249-2-21 conform to JEDEC JS709A standards.



Поставка электронных компонентов

Юридический адрес организации:
198099, г. Санкт-Петербург, ул. Калинина, дом 2, кор. 4, лит А.
Фактический адрес организации:
198099, г. Санкт-Петербург, ул. Калинина, дом 2, кор. 4, лит А.
ИНН 780277764
КПП 780501001
Р/С 40702810422510004035 ФАКБ "АБСОЛЮТ БАНК" (ЗАО) в Санкт-Петербурге К/С 30101810900000000703
БИК 044030703
Телефон: 8 (812) 309-44-11 (многоканальный)
Факс: 8 (812) 309-44-11
Электронная почта: sales@timechips.ru
Сайт: timechips.ru

Информационное письмо

Компания «ТаймЧипс» - одна из наиболее динамично развивающихся компаний в сфере поставок электронных компонентов. Мы поставляем широкую номенклатуру электронных компонентов отечественных и импортных производителей, как напрямую, так и с крупных мировых складов, позволяющих охватить выборочную номенклатуру более 300 брендов, а также специализируемся на поставках дисплеев и является официальным дистрибьютором компании Shenzhen Startek Electronic Technology Co, на территории Российской Федерации.

Наличие собственной логистики позволяет в кратчайшие сроки доставлять товар нашим клиентам. В нашей компании имеется Конструкторский отдел, где наши специалисты проводят технические консультации клиентов, квалифицированную поддержку и помощь российским разработчикам. Осуществляем Поставки импортной продукции под контролем ВП МО РФ, на предприятия Оборонно-промышленного комплекса России. Система менеджмента качества компании соответствует требованиям ГОСТ ISO 9001-2011.

Благодаря нацеленности на результат, мы уверенно занимаем новые позиции на рынке, заинтересовывая Клиента не только актуальными ценами и гибким подходом, но и постоянным вниманием.

Миссия – обеспечение долгосрочного и взаимовыгодного партнерства с клиентами.

Наша цель – Обеспечение клиентам самого широкого ассортимента электронных компонентов и бесперебойности поставок.

Мы - это развитие! Мы задаем темп! Мы разные, но вместе! Мы работаем для вас!

Так же имеем прямые поставки от производителей:

TAI-SAW Пав-компоненты (www.taisaw.com)

TRANSCOM СВЧ-компоненты (www.transcominc.com.tw)

Mini Circuits ВЧ-СВЧ-компоненты (minicircuits.com)

SAMTEC- разъемы (www.samtec.com)

4Star Разъемы РЧ (Даташиты по продукции 4Star, которые Вы сможете загрузить по этой ссылке: <https://yadi.sk/i/tPjnmGGrpmbYj>)

ULNION Преобразователи напряжения (converterdc.com/)

Отличные рекомендации на рынке, уверенность в качестве поставляемой продукции делают нас надежными партнерами для наших клиентов.

«ТаймЧипс» - это:

- Гарантия качества поставляемой продукции;
- Широкий ассортимент;
- Минимальные сроки поставок;
- Техническая поддержка;
- Подбор комплектации;
- Индивидуальный подход;
- Гибкие цены.

Модули, микросхемы, пассивные компоненты, Xilinx (XC), Altera (EP,EPF, EPM) и силовая электроника – это наши ведущие позиции, на поставку которых мы гарантированно дадим Вам самые выгодные предложения!

В структуру компании так же входит конструкторский отдел, который помогает разработчикам и конструкторам в решении следующих задач:

- Оценка стоимости проекта по компонентам;
- Подбор оптимального решения при выборе компонента;
- Подбор аналогов;
- Техническая поддержка;
- Консультации у производителей;
- Поставка прототипов;

С Уважением, Чернов Павел.

Руководитель отдела продаж ООО "ТАЙМЧИПС"

Официальный дистрибьютор Shenzhen Startek Electronic Technology Co.,Ltd в России (USB Display Modules , LED Displays, Serial Modules).

<http://www.timechips.ru/>

<http://lcd-timechips.ru/>

Телефон: +7 (812) 309-44-11 доб. 141

Факс: +7 (812) 309-44-11 доб. 152

Моб. Тел. +7 (905) 232-40-65

Skype: time.chips5

Электронная почта: manager1@timechips.ru
