

# POLYSWITCH RESETTABLE DEVICES

## Strap Battery Devices

Littelfuse PolySwitch, a pioneer of polymeric positive temperature coefficient (PPTC) resettable devices, offers several material platforms to help protect battery applications. Each of these material platforms offers different performance characteristics that allow the engineer greater design flexibility. PolySwitch devices for battery protection include SRP, LR4, VTP, VLP, VLR, MXP and MGP series, disc and special application strap devices.

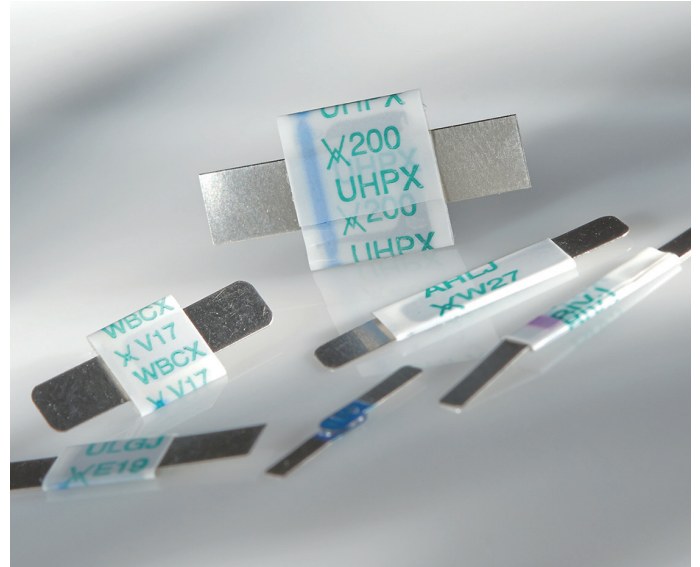

### BENEFITS

- Many material platforms and device form factors help provide engineers more design flexibility
- Compatible with high-volume electronics assembly
- Assists in meeting regulatory requirements
- Low-resistance devices increase battery operating time

### FEATURES

- RoHS compliant
- Lead-free versions of all devices are available
- Broad range of resettable devices available
- Current ratings from 1.1A to 13A
- Voltage ratings from 6V to 30V
- Agency recognition: UL, CSA, TÜV
- Fast time-to-trip
- Low resistance

### APPLICATIONS

- Mobile phone and smart phone battery packs
- Tablet PC battery packs
- Mobile radio battery packs
- Computer battery packs
- Digital camera battery packs
- Portable media player battery packs
- Power tools (charge line)

# PolySwitch Resettable Devices

## Strap Battery Devices

### Application Selection Guide

The guide below lists PolySwitch strap battery devices which are typically used in applications.

The following pages contain the specifications for the part numbers recommended below.

Once a device is selected, the user should evaluate and test each product for its intended application.

Protection Application	Additional Comments	PolySwitch Resettable Devices — Key Device Selection Criteria		
		Installation Method	Lowest Resistance	Lowest Thermal Cut-off
Mobile Phone Battery Packs	Li-ion	Surface-mount	Refer to Surface-mount Section of this Catalog	
		Prismatic	MXP370BD	VLR175F
Cordless Phone Battery Packs	NiMH	Cylindrical	VLP210F	—
			SRP175F	
Mobile Radio Battery Packs	NiMH	Cylindrical	LR4-380F	—
			SRP350F	
Computer Battery Packs	NiMH	Cylindrical	LR4-900F	—
	Li-ion	Cylindrical	LR4-1300SSF	—
		Prismatic	Consult Local Rep	Consult Local Rep
Camcorder Battery Packs	NiMH or Li-ion	Prismatic	VLP270F	VTP210GF
			LR4-380F	—
PDA Battery Packs	Li-ion	Prismatic	VLP220F	VLR175F
Power Tools (Charge Line)	NiCd, NiMH or Li-ion	Cylindrical	Custom LR4	Custom VTP

**Table B1 — Product Series - Current Rating, Voltage Rating /Typical Resistance**

Hold Current (A)	VLR	VLP	VTP	MXP	SRP	LR4
	Typical Activation Temperature					
	85°C	90°C	90°C	120°C	125°C	125°C
1.10	—	—	16V/0.054Ω	—	—	—
1.20	—	16V/0.053Ω	—	—	15V/0.123Ω	—
1.70	12V/0.025Ω	—	16V/0.041Ω	—	—	—
1.75	12V/0.024Ω	16V/0.032Ω	16V/0.040Ω	—	15V/0.070Ω	—
1.80	—	—	—	6V/0.0105Ω	—	—
1.90	—	—	—	6V/0.011Ω	—	15V/0.056Ω
2.00	—	—	—	—	30V/0.045Ω	—
2.10	—	16V/0.024Ω	16V/0.024Ω	—	—	—
2.20	—	16V/0.023Ω	—	—	—	—
2.30	12V/0.015Ω	—	—	—	—	—
2.50	—	—	—	6V/0.011Ω	—	—
2.60	—	—	—	—	—	15V/0.031Ω
2.70	—	16V/0.015Ω	—	6V/0.0105Ω	—	—
3.10	—	—	—	6V/0.0075Ω	—	—
3.50	—	—	—	—	30V/0.024Ω	—
3.70	—	—	—	6V/0.007Ω	—	—
3.80	—	—	—	—	—	15V/0.020Ω
4.20	—	—	—	—	30V/0.018Ω	—
4.50	—	—	—	—	—	20V/0.016Ω
5.50	—	—	—	—	—	20V/0.013Ω
6.00	—	—	—	—	—	20V/0.011Ω
7.30	—	—	—	—	—	20V/0.009Ω
9.00	—	—	—	—	—	20V/0.008Ω
13.00	—	—	—	—	—	20V/0.006Ω

# PolySwitch Resettable Devices

## Strap Battery Devices

Table B2 – Thermal Derating [Hold Current (A) at Ambient Temperature (°C)]

Part Number	Maximum Ambient Temperature												
	-40°C A	-20°C	0°C	20°C	25°C	40°C	50°C	60°C	70°C	80°C	85°C		
<b>85°C Typical Activation</b>													
<b>VLR*</b>													
VLR170F	3.5	2.9	2.4	1.84	1.70	1.2	1.0	0.7	0.3	—	—		
VLR175F	3.5	2.9	2.4	1.87	1.75	1.3	1.0	0.8	0.3	—	—		
VLR175LF	3.5	2.9	2.4	1.87	1.75	1.3	1.0	0.8	0.3	—	—		
VLR230F	5.0	4.2	3.4	2.52	2.30	1.7	1.3	0.9	0.4	—	—		
<b>90°C Typical Activation</b>													
<b>VLP*</b>													
VLP120UF	2.4	2.1	1.8	1.30	1.20	1.0	0.7	0.6	0.3	0.2	0.1		
VLP175UAF	3.2	2.7	2.3	1.70	1.75	1.2	1.0	0.9	0.5	0.2	0.1		
VLP210F	4.3	3.6	2.9	2.31	2.10	1.6	1.3	1.0	0.6	0.3	0.1		
VLP220F	4.5	3.8	3.0	2.45	2.20	1.7	1.4	1.1	0.7	0.3	0.1		
VLP270F	5.6	4.7	4.0	3.05	2.70	2.2	1.7	1.4	0.9	0.4	0.1		
<b>VTP*</b>													
VTP110F	2.0	1.7	1.4	1.12	1.10	0.85	0.75	0.7	0.4	0.2	0.1		
VTP170F	3.2	2.7	2.2	1.80	1.70	1.3	1.0	0.8	0.5	0.3	0.1		
VTP170XSF	3.2	2.7	2.2	1.80	1.70	1.3	1.0	0.8	0.5	0.3	0.1		
VTP175F	3.2	2.7	2.2	1.84	1.75	1.3	1.0	0.8	0.5	0.3	0.1		
VTP175LF	3.2	2.7	2.2	1.84	1.75	1.3	1.0	0.8	0.5	0.3	0.1		
VTP210GF	4.1	3.5	2.9	2.26	2.10	1.6	1.3	1.0	0.7	0.4	0.1		
VTP210SF	4.1	3.5	2.9	2.26	2.10	1.6	1.3	1.0	0.7	0.4	0.1		
Part Number	Maximum Ambient Temperature												
	-40°C A	-20°C	0°C	20°C	25°C	40°C	50°C	60°C	70°C	75°C	80°C	85°C	90°C
<b>120°C Typical Activation</b>													
<b>MXP*</b>													
MXP180	—	—	2.45	—	1.8	—	—	0.80	—	—	—	—	—
MXP190BB	—	—	2.6	—	1.9	—	—	0.85	—	—	—	—	—
MXP250K	—	—	3.6	—	2.5	—	—	1.3	—	—	—	—	—
MXP270	—	—	3.8	—	2.7	—	—	1.4	—	—	—	—	0.3
MXP310	—	—	5.0	—	3.1	—	—	1.9	—	1.0	—	—	—
MXP370BD	—	—	5.0	—	3.7	—	—	1.9	—	—	—	—	—
<b>120°C Typical Activation</b>													
<b>MGP</b>													
MGP450	—	—	—	—	4.5	—	—	2.6	—	—	—	—	—
MGP500	—	—	—	—	5.0	—	—	3.0	2.0	—	—	—	—
Part Number	Maximum Ambient Temperature												
	-40°C A	-20°C	0°C	20°C	25°C	40°C	50°C	60°C	70°C	80°C	85°C		
<b>125°C Typical Activation</b>													
<b>SRP</b>													
SRP120F	1.9	1.7	1.5	1.20	1.17	1.0	0.9	0.8	0.6	0.5	0.4		
SRP175F	2.5	2.2	2.0	1.75	1.68	1.4	1.3	1.2	1.0	0.9	0.8		
SRP200F	3.1	2.8	2.5	2.00	1.97	1.7	1.5	1.4	1.2	1.0	0.9		
SRP350F	5.3	4.8	4.3	3.50	3.44	3.0	2.7	2.5	2.1	1.8	1.7		
SRP420F	6.3	5.7	5.1	4.20	4.11	3.6	3.3	3.0	2.6	2.2	2.1		
<b>LR4</b>													
LR4-190F	2.8	2.5	2.3	1.9	1.86	1.6	1.5	1.4	1.2	1.1	1.0		
LR4-260F	3.8	3.4	3.1	2.6	2.54	2.2	2.0	1.9	1.7	1.4	1.3		
LR4-380F	5.4	4.9	4.4	3.8	3.64	3.3	3.0	2.8	2.5	2.3	2.1		
LR4-380XF	5.4	4.9	4.4	3.8	3.64	3.3	3.0	2.8	2.5	2.3	2.1		
LR4-450F	6.5	5.8	5.3	4.5	4.38	3.9	3.6	3.3	2.9	2.6	2.4		
LR4-550F	7.6	6.9	6.2	5.5	5.32	4.7	4.3	4.0	3.6	3.2	3.0		
LR4-600F	8.7	7.8	7.1	6.0	5.86	5.2	4.7	4.4	3.9	3.4	3.2		
LR4-600XF	8.7	7.8	7.1	6.0	5.86	5.2	4.7	4.4	3.9	3.4	3.2		
LR4-730F	10.5	9.5	8.6	7.3	7.13	6.3	5.7	5.4	4.7	4.2	4.0		
LR4-900F	12.7	11.4	10.0	9.0	8.50	7.5	6.8	6.2	5.5	4.9	4.5		
LR4-1300SSF	17.9	16.2	14.5	13.0	12.40	11.1	10.3	9.5	8.6	7.7	7.2		

\* Product electrical characteristics determined at 25°C.

# PolySwitch Resettable Devices

## Strap Battery Devices

Figure B1 – Thermal Derating Curve

- A = LR4
- B = SRP
- C = VTP, VLP, MXP
- D = MGP
- E = VLR
- F = RSD

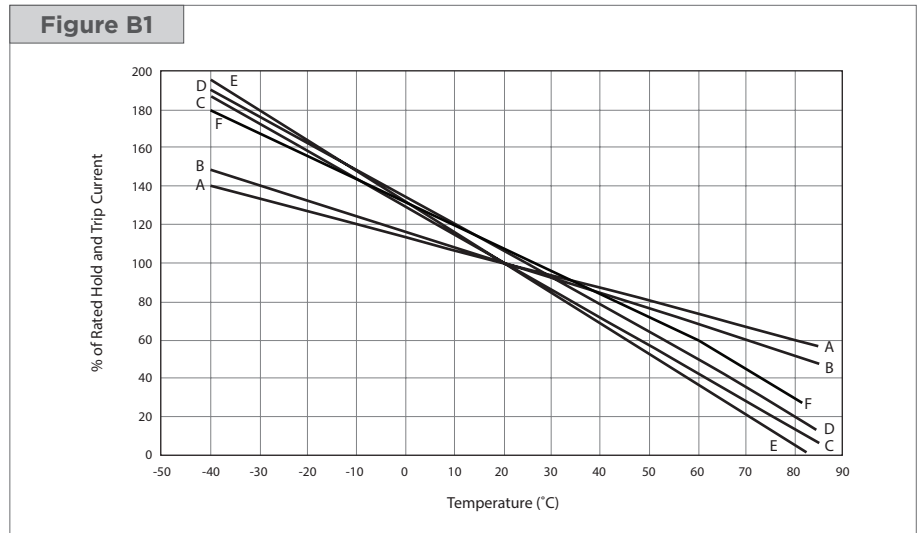

Table B3 – Electrical Characteristics

Part Number	I <sub>H</sub> (A)	I <sub>T</sub> (A)	V <sub>MAX</sub> (V <sub>DC</sub> )	I <sub>MAX</sub> (A)	P <sub>D MAX</sub> (W)	Max Time-to-trip		R <sub>MIN</sub> (Ω)	R <sub>MAX</sub> (Ω)	R <sub>1MAX</sub> (Ω)	Figure for Dimension
						(A)	(s)				
<b>85°C Typical Activation</b>											
<b>VLR*</b>											
VLR170F	1.70	4.1	12	100	1.4	8.50	5.0	0.018	0.032	0.064	B3
VLR175F	1.75	4.2	12	100	1.4	8.75	5.0	0.017	0.031	0.062	B3
VLR175LF	1.75	4.2	12	100	1.4	8.75	5.0	0.017	0.031	0.062	B3
VLR230F	2.30	5.0	12	100	2.5	10.00	5.0	0.012	0.018	0.036	B3
<b>90°C Typical Activation</b>											
<b>VLP*</b>											
VLP120UF	1.20	3.6	16	60	1.6	7.00	5.0	0.039	0.067	0.134	B5
VLP175UAF	1.75	3.9	16	60	1.8	8.75	5.0	0.023	0.041	0.082	B5
VLP210F	2.10	5.0	16	60	1.8	10.50	5.0	0.018	0.030	0.060	B2
VLP220F	2.20	5.3	16	60	1.8	11.00	5.0	0.017	0.029	0.058	B3
VLP270F	2.70	6.5	16	60	2.5	13.50	5.0	0.012	0.018	0.036	B3
<b>VTP*</b>											
VTP110F	1.10	2.7	16	100	1.3	5.50	5.0	0.038	0.070	0.140	B5
VTP170F	1.70	3.4	16	100	1.4	8.50	5.0	0.030	0.052	0.105	B2
VTP170XSF	1.70	3.4	16	100	1.4	8.50	5.0	0.030	0.052	0.105	B4
VTP175F	1.75	3.6	16	100	1.4	8.75	5.0	0.029	0.051	0.102	B3
VTP175LF	1.75	3.6	16	100	1.4	8.75	5.0	0.029	0.051	0.102	B3
VTP210GF	2.10	4.7	16	100	1.5	10.00	5.0	0.018	0.030	0.060	B3
VTP210SF	2.10	4.7	16	100	1.5	10.00	5.0	0.018	0.030	0.060	B4
<b>120°C Typical Activation</b>											
<b>MXP*</b>											
MXP180	1.80	5.2	6	50	1.0	9.00	5.0	0.007	0.014	0.024	B10
MXP190BB	1.90	4.9	6	50	1.0	9.50	2.0	0.007	0.015	0.024	B9
MXP250K	2.50	6.2	6	50	1.0	13.50	2.0	0.006	0.016	0.028	B10
MXP270	2.70	6.2	6	50	1.0	13.50	2.0	0.006	0.015	0.026	B10
MXP310	3.10	9.0	6	50	1.3	17.50	5.0	0.003	0.012	0.018	B10
MXP370BD	3.70	9.0	6	50	1.3	18.50	5.0	0.004	0.010	0.016	B10

\* Product electrical characteristics determined at 25°C.

# PolySwitch Resettable Devices

## Strap Battery Devices

Table B3 – Electrical Characteristics

(Cont'd)

Part Number	$I_H$ (A)	$I_T$ (A)	$V_{MAX}$ (V <sub>DC</sub> )	$I_{MAX}$ (A)	$P_{D MAX}$ (W)	Max Time-to-trip		$R_{MIN}$ ( $\Omega$ )	$R_{MAX}$ ( $\Omega$ )	$R_{1MAX}$ ( $\Omega$ )	Figure for Dimension
						(A)	(s)				
<b>120°C Typical Activation</b>											
<b>MGP</b>											
MGP450	4.50	9.2	6	50	1.5	25.00	5.0	0.0025	0.007	0.013	B11
MGP500	5.00	9.2	6	50	1.5	25.00	5.0	0.0025	0.0065	0.013	B12
<b>125°C Typical Activation</b>											
<b>SRP</b>											
SRP120F	1.20	2.7	15	100	1.2	6.00	5.0	0.085	0.160	0.220	B6
SRP175F	1.75	3.8	15	100	1.5	8.75	5.0	0.050	0.090	0.120	B6
SRP200F	2.00	4.4	30	100	1.9	10.00	4.0	0.030	0.060	0.100	B6
SRP350F	3.50	6.3	30	100	2.5	20.00	3.0	0.017	0.031	0.050	B6
SRP420F	4.20	7.6	30	100	2.9	20.00	6.0	0.012	0.024	0.040	B6
<b>LR4</b>											
LR4-190F	1.90	3.9	15	100	1.2	9.5	5.0	0.0390	0.0720	0.102	B7
LR4-260F	2.60	5.8	15	100	2.5	13.0	5.0	0.0200	0.0420	0.063	B7
LR4-380F	3.80	8.3	15	100	2.5	19.0	5.0	0.0130	0.0260	0.037	B7
LR4-380XF	3.80	8.3	15	100	2.5	19.0	5.0	0.0130	0.0260	0.037	B7
LR4-450F	4.50	8.9	20	100	2.3	22.5	5.0	0.0110	0.0200	0.028	B7
LR4-550F	5.50	10.5	20	100	2.8	27.5	5.0	0.0090	0.0160	0.022	B7
LR4-600F	6.00	11.7	20	100	2.8	30.0	5.0	0.0070	0.0140	0.019	B7
LR4-600XF	6.00	11.7	20	100	2.8	30.0	5.0	0.0075	0.0140	0.019	B7
LR4-730F	7.30	14.1	20	100	3.3	30.0	5.0	0.0060	0.0120	0.015	B7
LR4-900F	9.00	16.7	20	100	3.8	45.0	5.0	0.0060	0.0100	0.014	B7
LR4-1300SSF	13.00	21.2	20	100	4.5	50.0	10.0	0.0035	0.0065	0.009	B8

\* Product electrical characteristics determined at 25°C.

**Notes**

- $I_H$  : Hold current: maximum current device will pass without interruption in 20°C still air unless otherwise specified.
- $I_T$  : Trip current: minimum current that will switch the device from low-resistance to high-resistance in 20°C still air unless otherwise specified.
- $V_{MAX}$  : Maximum voltage device can withstand without damage at rated current.
- $I_{MAX}$  : Maximum fault current device can withstand without damage at rated voltage.
- $P_D$  : Power dissipated from device when in the tripped state in 20°C still air unless otherwise specified.
- $R_{MIN}$  : Minimum resistance of device as supplied at 20°C unless otherwise specified.
- $R_{MAX}$  : Maximum resistance of device as supplied at 20°C unless otherwise specified.
- $R_{1MAX}$  : Maximum resistance, measured at 20°C unless otherwise specified, of device one hour after being tripped the first time.

### Figures B2-B12 – Dimension Figures

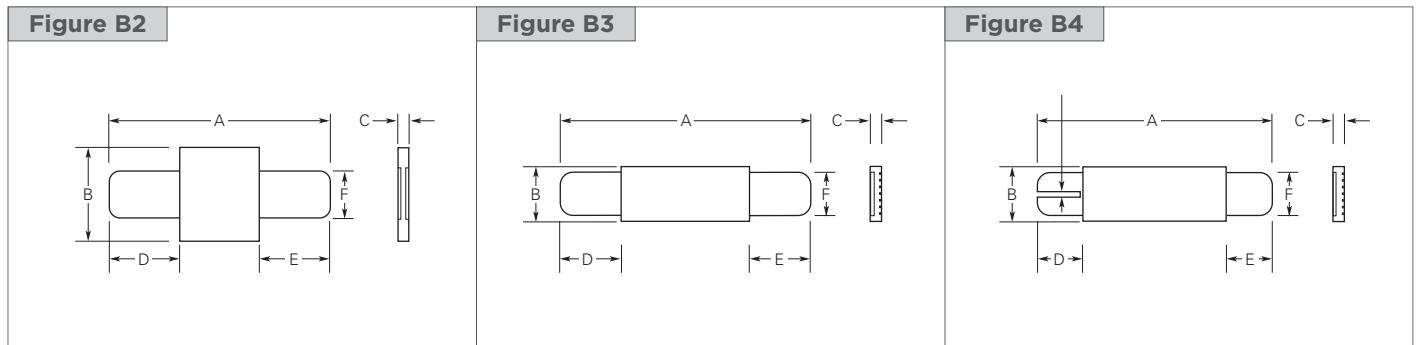

# PolySwitch Resettable Devices

## Strap Battery Devices

### Figures B2-B12 – Dimension Figures

(Cont'd)

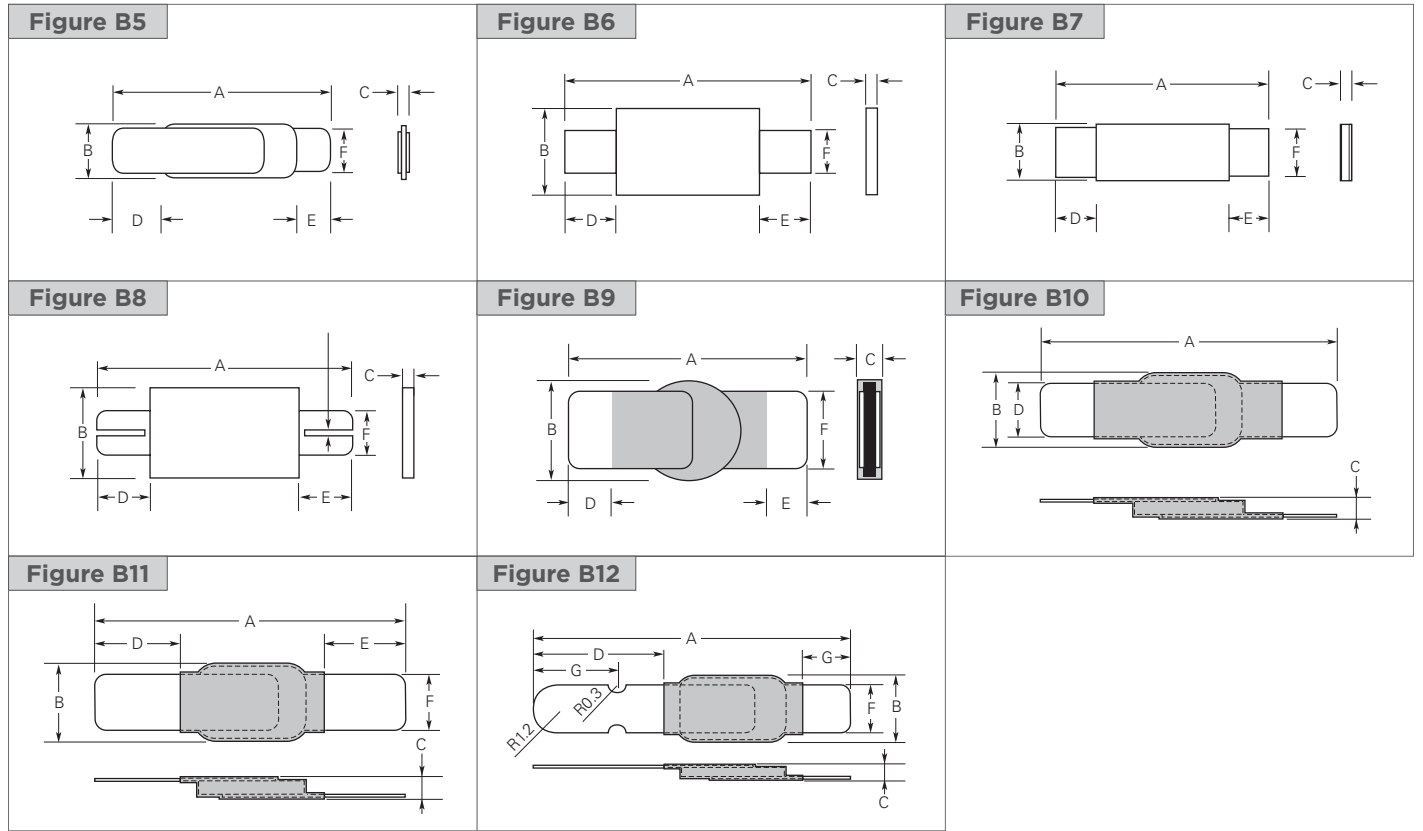

Table B4 – Dimensions in Millimeters (Inches)

Part Number	A		B		C		D		E		F		G		Figure
	Min	Max	Min	Max	Min	Max	Min	Max	Min	Max	Min	Max	Min	Max	
<b>85°C Typical Activation</b>															
<b>VLR</b>															
VLR170F	20.8 (0.832)	23.2 (0.928)	3.5 (0.140)	3.9 (0.156)	—	0.8 (0.032)	4.5 (0.180)	6.5 (0.260)	4.5 (0.180)	6.5 (0.260)	2.4 (0.096)	2.6 (0.104)	—	—	B3
VLR175F	23.0 (0.920)	24.5 (0.980)	2.9 (0.116)	3.3 (0.132)	0.5 (0.020)	0.8 (0.032)	4.7 (0.188)	7.2 (0.288)	3.8 (0.152)	5.4 (0.216)	2.4 (0.096)	2.6 (0.104)	—	—	B3
VLR175LF	29.3 (1.172)	31.7 (1.268)	2.9 (0.116)	3.3 (0.132)	—	0.8 (0.032)	5.2 (0.208)	6.8 (0.272)	10 (0.400)	12.5 (0.500)	2.4 (0.096)	2.6 (0.104)	—	—	B3
VLR230F	20.9 (0.836)	23.1 (0.924)	4.9 (0.196)	5.3 (0.212)	—	0.8 (0.032)	4.1 (0.164)	5.8 (0.232)	4.1 (0.164)	5.8 (0.232)	3.9 (0.156)	4.1 (0.164)	—	—	B3
<b>90°C Typical Activation</b>															
<b>VLP</b>															
VLP120UF	10.9 (0.430)	11.8 (0.460)	4.4 (0.170)	4.6 (0.180)	—	0.7 (0.028)	5.5 (0.220)	6.5 (0.260)	1.65 (0.065)	1.9 (0.075)	2.3 (0.091)	2.5 (0.098)	—	—	B5
VLP175UAF	23.6 (0.944)	25.6 (1.024)	2.7 (0.108)	2.9 (0.116)	—	0.7 (0.028)	7.0 (0.280)	8.0 (0.320)	7.0 (0.280)	8.0 (0.320)	2.3 (0.092)	2.5 (0.100)	—	—	B5
VLP210F	15.4 (0.616)	17.5 (0.700)	6.9 (0.276)	7.3 (0.292)	0.6 (0.024)	0.8 (0.032)	4.0 (0.160)	6.2 (0.248)	4.0 (0.160)	6.2 (0.248)	3.9 (0.156)	4.1 (0.164)	—	—	B2
VLP220F	21.1 (0.844)	23.3 (0.932)	3.5 (0.140)	3.9 (0.156)	0.6 (0.024)	0.8 (0.032)	5.1 (0.204)	6.8 (0.272)	5.1 (0.204)	6.8 (0.272)	2.9 (0.116)	3.1 (0.124)	—	—	B3
VLP270F	20.9 (0.836)	23.1 (0.924)	4.9 (0.196)	5.3 (0.212)	0.6 (0.024)	0.8 (0.032)	4.1 (0.164)	5.8 (0.232)	4.1 (0.164)	5.8 (0.232)	3.9 (0.156)	4.1 (0.164)	—	—	B3

# PolySwitch Resettable Devices

## Strap Battery Devices

Table B4 – Dimensions in Millimeters (Inches)

(Cont'd)

Part Number	A		B		C		D		E		F		G		Figure
	Min	Max	Min	Max	Min	Max	Min	Max	Min	Max	Min	Max	Min	Max	
<b>VTP</b>															
VTP110F	23.6 (0.944)	25.6 (1.024)	2.7 (0.108)	2.9 (0.116)	— (0.028)	0.7 (0.028)	7.0 (0.280)	8.0 (0.320)	7.0 (0.280)	8.0 (0.320)	2.3 (0.092)	2.5 (0.100)	— (0.000)	— (0.000)	B5
VTP170F	15.4 (0.616)	17.5 (0.700)	7.0 (0.280)	7.4 (0.296)	0.5 (0.020)	0.8 (0.032)	4.0 (0.160)	6.2 (0.248)	4.0 (0.160)	6.2 (0.248)	3.9 (0.156)	4.1 (0.164)	— (0.000)	— (0.000)	B2
VTP170XSF	20.9 (0.836)	22.9 (0.916)	4.9 (0.196)	5.3 (0.212)	0.5 (0.020)	0.8 (0.032)	6.0 (0.240)	8.6 (0.344)	6.0 (0.240)	8.6 (0.344)	3.9 (0.156)	4.1 (0.164)	— (0.000)	— (0.000)	B4
VTP175F	21.2 (0.848)	23.2 (0.928)	3.5 (0.140)	3.9 (0.156)	— (0.032)	0.8 (0.032)	4.6 (0.184)	6.6 (0.264)	4.6 (0.184)	6.6 (0.264)	2.9 (0.116)	3.1 (0.124)	— (0.000)	— (0.000)	B3
VTP175LF	25.8 (1.032)	28.2 (1.128)	3.5 (0.140)	3.9 (0.156)	— (0.032)	0.8 (0.032)	5.7 (0.228)	7.3 (0.292)	8.7 (0.348)	10.3 (0.412)	2.4 (0.096)	2.6 (0.104)	— (0.000)	— (0.000)	B3
VTP210GF	20.9 (0.836)	23.1 (0.924)	4.9 (0.196)	5.3 (0.212)	— (0.032)	0.8 (0.032)	4.1 (0.164)	5.8 (0.232)	4.1 (0.164)	5.8 (0.232)	3.9 (0.156)	4.1 (0.164)	— (0.000)	— (0.000)	B3
VTP210SF	20.9 (0.836)	23.1 (0.924)	4.9 (0.196)	5.3 (0.212)	0.6 (0.024)	0.8 (0.032)	4.1 (0.164)	5.8 (0.232)	4.1 (0.164)	5.8 (0.232)	3.9 (0.156)	4.1 (0.164)	— (0.000)	— (0.000)	B4
<b>120°C Typical Activation</b>															
<b>MXP</b>															
MXP180	9.4 (0.37)	10.0 (0.39)	2.3 (0.09)	2.6 (0.10)	0.7 (0.02)	1.1 (0.04)	1.9 (0.07)	2.1 (0.08)	— (0.000)	— (0.000)	— (0.000)	— (0.000)	— (0.000)	— (0.000)	B10
MXP190BB	9.2 (0.36)	10.8 (0.43)	2.96 (0.12)	3.26 (0.13)	0.7 (0.03)	1.1 (0.04)	1.6 (0.06)	3.1 (0.12)	1.6 (0.06)	3.1 (0.12)	2.2 (0.09)	2.4 (0.10)	— (0.000)	— (0.000)	B9
MXP250K	11.75 (0.46)	12.35 (0.49)	2.3 (0.09)	2.7 (0.11)	0.7 (0.03)	1.1 (0.04)	2.4 (0.09)	2.6 (0.10)	— (0.000)	— (0.000)	— (0.000)	— (0.000)	— (0.000)	— (0.000)	B10
MXP270	10.3 (0.40)	11.5 (0.45)	2.3 (0.09)	2.7 (0.10)	0.7 (0.02)	1.1 (0.04)	2.1 (0.08)	— (0.000)	2.1 (0.08)	— (0.000)	1.9 (0.07)	2.1 (0.08)	— (0.000)	— (0.000)	B9
MXP310	14.5 (0.57)	16.5 (0.65)	2.96 (0.11)	3.26 (0.13)	0.65 (0.03)	0.95 (0.04)	4.6 (0.18)	— (0.000)	4.6 (0.18)	— (0.000)	2.2 (0.09)	2.4 (0.10)	— (0.000)	— (0.000)	B9
MXP370BD	10.5 (0.41)	11.3 (0.44)	2.96 (0.11)	3.26 (0.12)	0.7 (0.02)	1.1 (0.04)	2.0 (0.07)	— (0.000)	2.0 (0.07)	— (0.000)	2.2 (0.08)	2.4 (0.09)	— (0.000)	— (0.000)	B9
<b>120°C Typical Activation</b>															
<b>MGP</b>															
MGP450	13.0 (0.51)	14.0 (0.55)	2.96 (0.12)	3.26 (0.13)	— (0.000)	0.95 (0.04)	3.0 (0.12)	— (0.000)	3.0 (0.12)	— (0.000)	2.2 (0.09)	2.4 (0.09)	— (0.000)	— (0.000)	B11
MGP500	14.5 (0.57)	15.5 (0.61)	2.96 (0.12)	3.26 (0.13)	— (0.000)	0.95 (0.04)	5.5 (0.22)	7.0 (0.28)	2.0 (0.08)	— (0.000)	2.3 (0.09)	2.5 (0.10)	3.95 (0.16)	4.05 (0.16)	B12
<b>125°C Typical Activation</b>															
<b>SRP</b>															
SRP120F	19.9 (0.796)	22.1 (0.884)	4.9 (0.196)	5.2 (0.208)	0.6 (0.024)	1.0 (0.040)	5.5 (0.220)	7.5 (0.300)	5.5 (0.220)	7.5 (0.300)	3.9 (0.156)	4.1 (0.164)	— (0.000)	— (0.000)	B6
SRP175F	20.9 (0.836)	23.1 (0.924)	4.9 (0.196)	5.2 (0.208)	0.6 (0.024)	1.0 (0.040)	4.1 (0.164)	5.5 (0.220)	4.1 (0.164)	5.5 (0.220)	3.9 (0.156)	4.1 (0.164)	— (0.000)	— (0.000)	B6
SRP200F	21.3 (0.852)	23.4 (0.936)	10.2 (0.408)	11.0 (0.440)	0.5 (0.020)	1.1 (0.044)	5.0 (0.200)	7.6 (0.304)	5.0 (0.200)	7.6 (0.304)	4.8 (0.192)	5.4 (0.216)	— (0.000)	— (0.000)	B6
SRP350F	28.4 (1.136)	31.8 (1.272)	13.0 (0.520)	13.5 (0.540)	0.5 (0.020)	1.1 (0.044)	6.3 (0.252)	8.9 (0.356)	6.3 (0.252)	8.9 (0.356)	6.0 (0.240)	6.6 (0.264)	— (0.000)	— (0.000)	B6
SRP420F	30.6 (1.224)	32.4 (1.296)	12.9 (0.516)	13.6 (0.544)	0.5 (0.020)	1.1 (0.044)	5.0 (0.200)	7.5 (0.300)	5.0 (0.200)	7.5 (0.300)	6.0 (0.240)	6.7 (0.268)	— (0.000)	— (0.000)	B6

# PolySwitch Resettable Devices

## Strap Battery Devices

Table B4 – Dimensions in Millimeters (Inches)

(Cont'd)

Part Number	A		B		C		D		E		F		G		Figure
	Min	Max	Min	Max	Min	Max	Min	Max	Min	Max	Min	Max	Min	Max	
<b>LR4</b>															
LR4-190F	19.9 (0.796)	22.1 (0.884)	4.9 (0.196)	5.5 (0.220)	0.6 (0.024)	1.0 (0.040)	5.5 (0.220)	7.5 (0.300)	5.5 (0.220)	7.5 (0.300)	3.9 (0.156)	4.1 (0.164)	—	—	B7
LR4-260F	20.9 (0.836)	23.1 (0.924)	4.9 (0.196)	5.5 (0.220)	0.6 (0.024)	1.0 (0.040)	4.1 (0.164)	5.5 (0.220)	4.1 (0.164)	5.5 (0.220)	3.9 (0.156)	4.1 (0.164)	—	—	B7
LR4-380F	24.0 (0.960)	26.0 (1.040)	6.9 (0.276)	7.5 (0.300)	0.6 (0.024)	1.0 (0.040)	4.1 (0.164)	5.5 (0.220)	4.1 (0.164)	5.5 (0.220)	4.9 (0.196)	5.1 (0.204)	—	—	B7
LR4-380XF	32.2 (1.288)	35.8 (1.432)	4.9 (0.196)	5.5 (0.220)	0.6 (0.024)	1.0 (0.040)	5.5 (0.220)	7.5 (0.300)	5.5 (0.220)	7.5 (0.300)	3.9 (0.156)	4.1 (0.164)	—	—	B7
LR4-450F	24.0 (0.960)	26 (1.040)	9.9 (0.396)	10.5 (0.420)	0.6 (0.024)	1.0 (0.040)	5.3 (0.212)	6.7 (0.268)	5.3 (0.212)	6.7 (0.268)	5.9 (0.236)	6.1 (0.244)	—	—	B7
LR4-550F	35.0 (1.400)	37.0 (1.480)	6.9 (0.276)	7.5 (0.300)	0.6 (0.024)	1.0 (0.040)	5.3 (0.212)	6.7 (0.268)	5.3 (0.212)	6.7 (0.268)	4.9 (0.196)	5.1 (0.204)	—	—	B7
LR4-600F	24.0 (0.960)	26.0 (1.040)	13.9 (0.556)	14.5 (0.580)	0.6 (0.024)	1.0 (0.040)	4.1 (0.164)	5.5 (0.220)	4.1 (0.164)	5.5 (0.220)	5.9 (0.236)	6.1 (0.244)	—	—	B7
LR4-600XF	40.5 (1.620)	42.7 (1.708)	6.9 (0.276)	7.5 (0.300)	0.6 (0.024)	1.0 (0.040)	5.2 (0.208)	6.8 (0.272)	5.2 (0.208)	6.8 (0.272)	4.9 (0.196)	5.1 (0.204)	—	—	B7
LR4-730F	27.1 (1.084)	29.1 (1.164)	13.9 (0.556)	14.5 (0.580)	0.6 (0.024)	1.0 (0.040)	4.1 (0.164)	5.5 (0.220)	4.1 (0.164)	5.5 (0.220)	5.9 (0.236)	6.1 (0.244)	—	—	B7
LR4-900F	45.4 (1.816)	47.6 (1.904)	7.9 (0.316)	8.5 (0.340)	0.9 (0.036)	1.3 (0.052)	4.6 (0.184)	6.2 (0.248)	4.6 (0.184)	6.2 (0.248)	5.9 (0.236)	6.1 (0.244)	—	—	B7
LR4-1300SSF	61.5 (2.460)	66.5 (2.660)	9.4 (0.376)	10.0 (0.400)	0.9 (0.036)	1.3 (0.052)	5.0 (0.200)	7.5 (0.300)	5.0 (0.200)	7.5 (0.300)	5.9 (0.236)	6.1 (0.244)	—	—	B8

Figures B13-B19 – Typical Time-to-Trip Curve at 20°C

**VLR (data at 25°C)**

- A = VLR170F
- B = VLR175F
- C = VLR230F

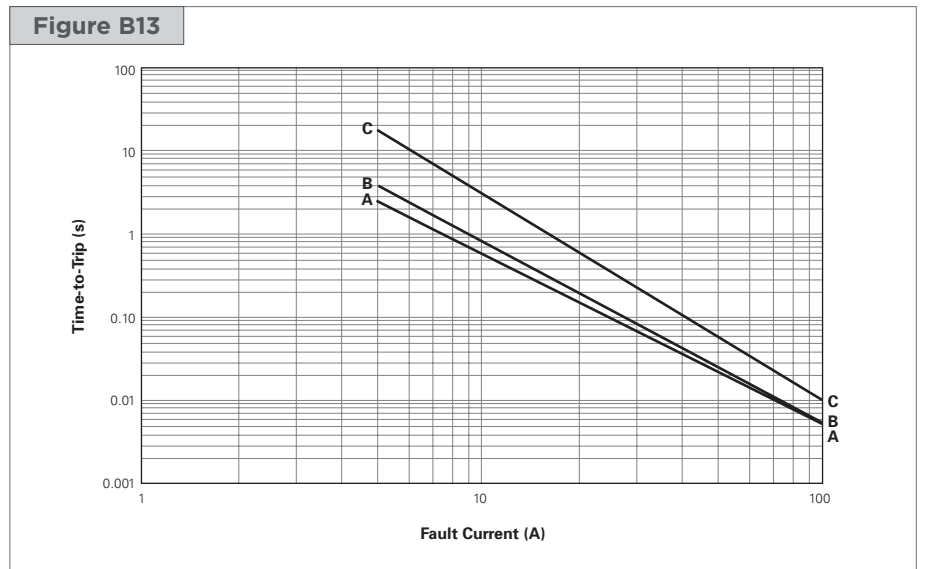



# PolySwitch Resettable Devices

## Strap Battery Devices

### Figures B13-B19 – Typical Time-to-Trip Curve at 20°C

(Cont'd)

#### VLP (data at 25°C)

- A = VLP120UF
- B = VLP175UAF
- C = VLP210F
- D = VLP220F
- E = VLP270F

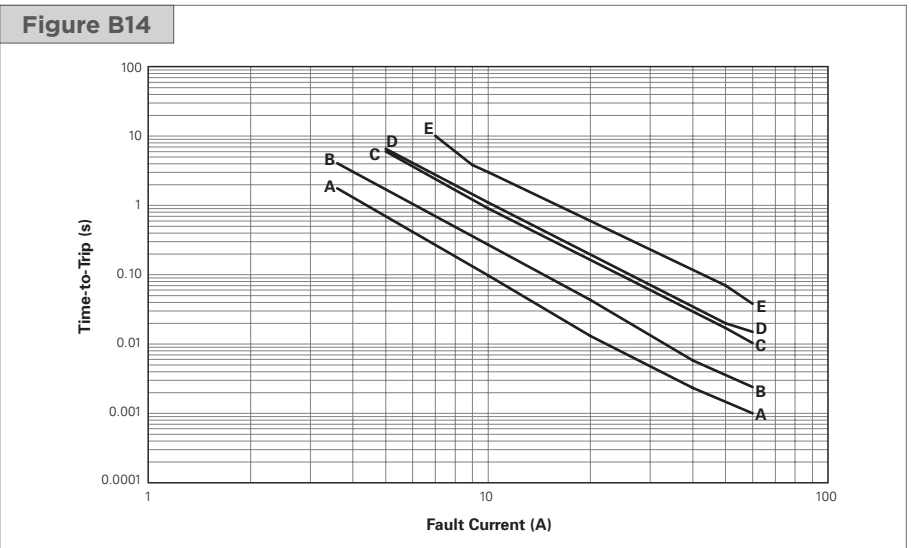

#### VTP (data at 25°C)

- A = VTP110F
- B = VTP170F
- C = VTP175F
- D = VTP210GF

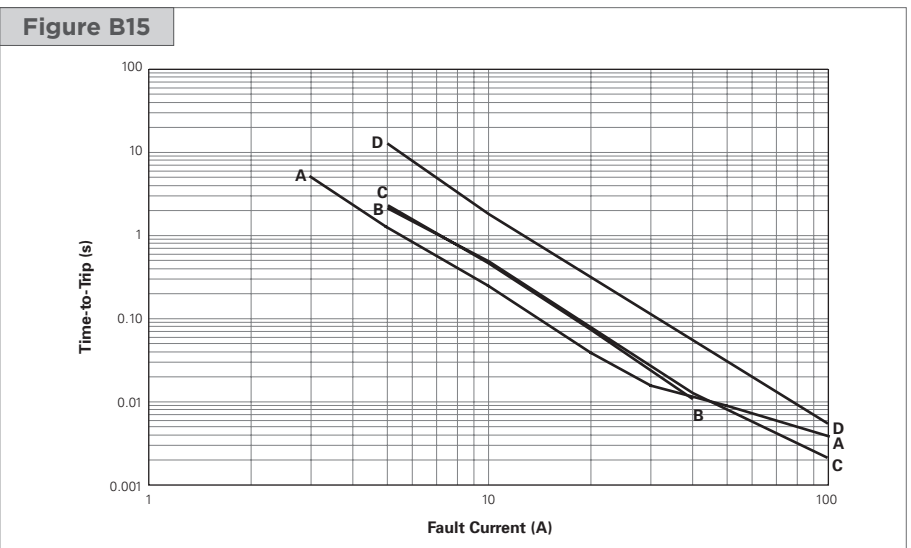

#### MXP (data at 25°C)

- A = MXP180
- B = MXP190BB
- C = MXP250K
- D = MXP270
- E = MXP310
- F = MXP370BD

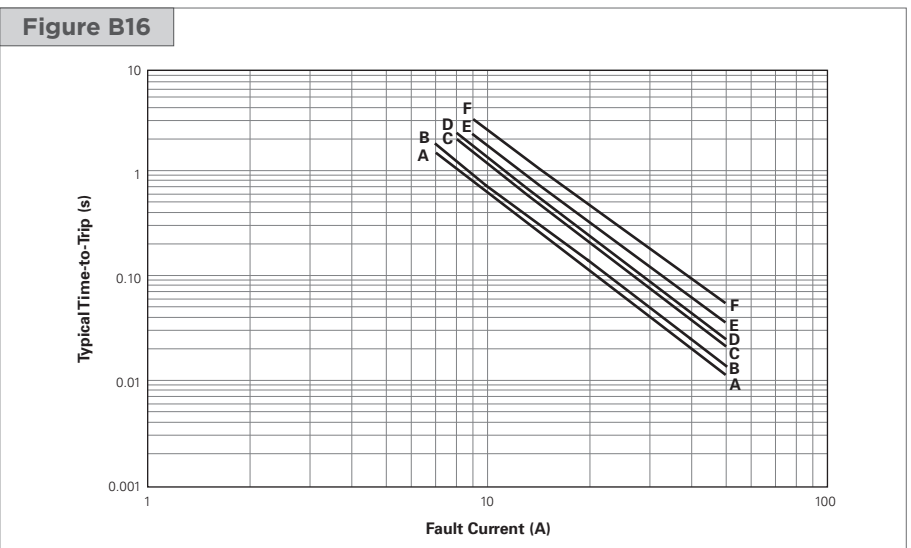

# PolySwitch Resettable Devices

## Strap Battery Devices

### Figures B13-B19 – Typical Time-to-Trip Curve at 20°C

(Cont'd)

#### MGP

- A = MGP450
- B = MGP500

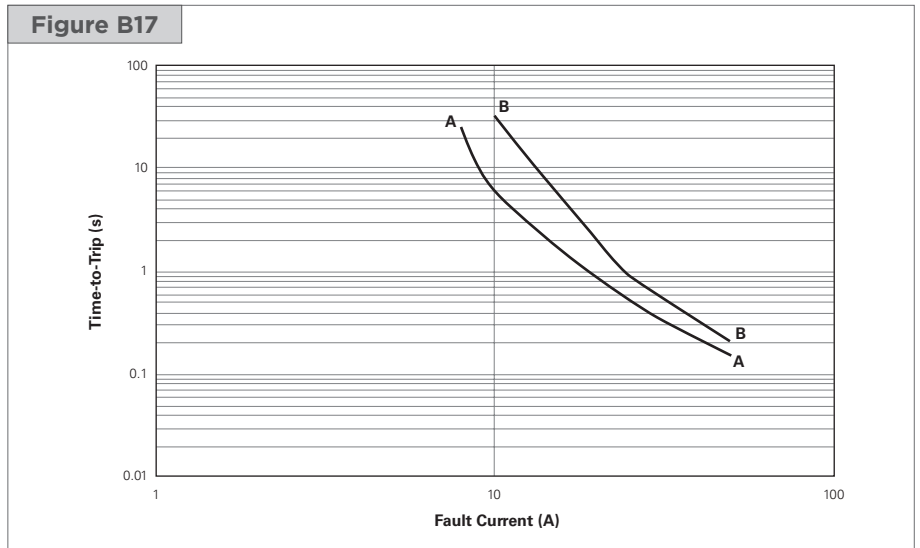

#### SRP

- A = SRP120F
- B = SRP175F
- C = SRP200F
- D = SRP350F
- E = SRP420F

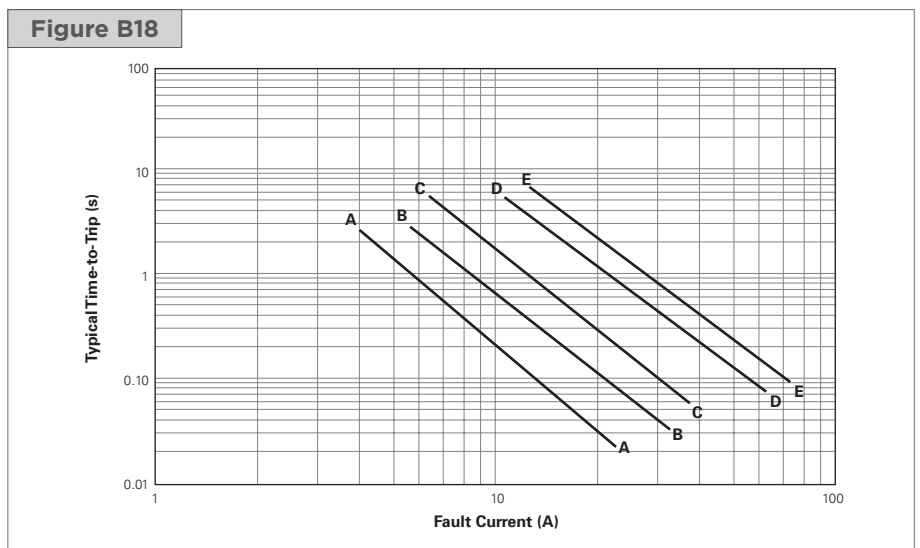

#### LR4

- A = LR4-190F
- B = LR4-260F
- C = LR4-380F
- D = LR4-450F
- E = LR4-550F
- F = LR4-600F
- G = LR4-730F
- H = LR4-900F
- I = LR4-1300SSF

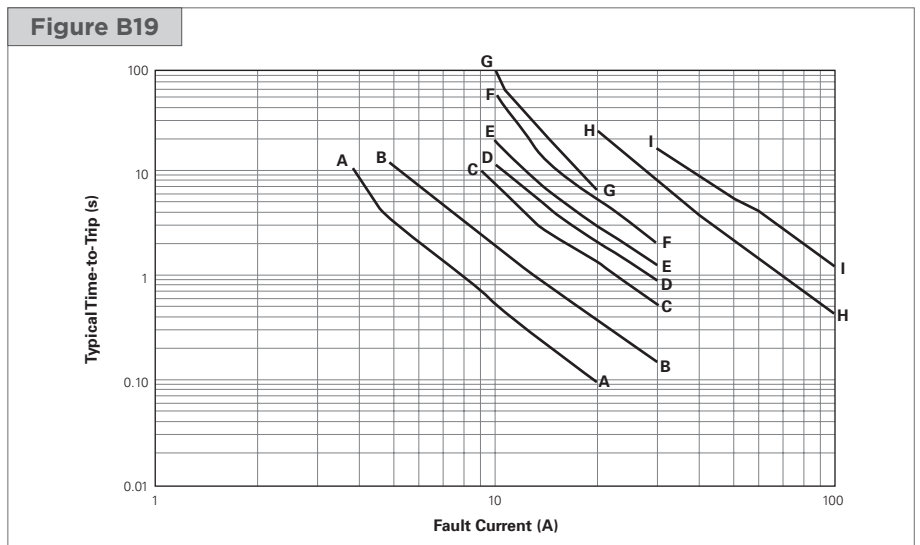

# PolySwitch Resettable Devices

## Strap Battery Devices

Table B5 – Physical Characteristics and Environmental Specifications

VLR		
Physical Characteristics		
Lead Material	0.125mm Nominal Thickness, Quarter-hard Nickel	
Tape Material	Polyester	
Environmental Specifications		
Test	Conditions	Resistance Change
Passive Aging	-40°C, 1000 hrs	±5% typ
	60°C, 1000 hrs	±20% typ
Humidity Aging	60°C/95% RH, 1000 hrs	±30% typ
Thermal Shock	85°C, -40°C (10 Times)	±5% typ
Vibration	MIL-STD-883D, Method 2026	No Change
VLP and VTP		
Physical Characteristics		
Lead Material	0.125mm Nominal Thickness, Quarter-hard Nickel	
Tape Material	Polyester	
Environmental Specifications		
Test	Conditions	Resistance Change
Passive Aging	-40°C, 1000 hrs	±5% typ
	60°C, 1000 hrs	±10% typ
Humidity Aging	60°C/95% RH, 1000 hrs	±10% typ
Thermal Shock	85°C, -40°C (10 Times)	±5% typ
Vibration	MIL-STD-883D, Method 2026	No Change
MXP and MGP		
Physical Characteristics		
Lead Material	0.1mm Nominal Thickness, Half-hard Nickel	
Coating Material	Epoxy	
Environmental Specifications		
Test	Conditions	Resistance Change
Passive Aging	-40°C, 1000 hrs	±5% typ
	60°C, 1000 hrs	±20% typ
Humidity Aging	60°C/95% RH, 1000 hrs	±30% typ
Thermal Shock	85°C, -40°C (10 Times)	±5% typ
Vibration	MIL-STD-883D, Method 2026	No Change
SRP		
Physical Characteristics		
Lead Material	0.125mm Nominal Thickness, Quarter-hard Nickel	
Tape Material	Polyester	
Environmental Specifications		
Test	Conditions	Resistance Change
Passive Aging	70°C, 1000 hrs	±10% typ
Humidity Aging	85°C/85% RH, 7 Days	±5% typ
Vibration	MIL-STD-883C, Test Condition A	No Change

**Note:** Storage conditions: 40°C max., 70% RH max.; devices should remain in original sealed bags prior to use. Devices may not meet specified values if these storage conditions are exceeded.

# PolySwitch Resettable Devices

## Strap Battery Devices

Table B5 — Physical Characteristics and Environmental Specifications

(Cont'd)

LR4		
Physical Characteristics		
Lead Material	0.125mm Nominal Thickness, Quarter-hard Nickel	
Tape Material	Polyester	
Environmental Specifications		
Test	Conditions	Resistance Change
Passive Aging	70°C, 1000 hrs	±10% typ
Humidity Aging	85°C/85% RH, 7 Days	±5% typ
Vibration	MIL-STD-883D, Method 2026	No Change

**Note:** Storage conditions: 40°C max., 70% RH max.; devices should remain in original sealed bags prior to use. Devices may not meet specified values if these storage conditions are exceeded.

Table B6 — Packaging and Marking Information/Agency Recognition

Part Number	Bag Quantity	Tape and Reel Quantity	Standard Package Quantity	Part Marking	Agency Recognition
<b>85°C Typical Activation</b>					
<b>VLR</b>					
VLR170F	1,000	—	10,000	R17	UL, CSA, TÜV
VLR175F	1,000	—	10,000	R1X	UL, CSA, TÜV
VLR175LF	1,000	—	10,000	R1X	UL, CSA, TÜV
VLR230F	1,000	—	10,000	R23	UL, CSA, TÜV
<b>90°C Typical Activation</b>					
<b>VLP</b>					
VLP120UF	1,000	—	10,000	—	UL, CSA, TÜV
VLP175UAF	1,000	—	10,000	—	UL, CSA, TÜV
VLP210F	1,000	—	10,000	W21	UL, CSA, TÜV
VLP220F	1,000	—	10,000	W22	UL, CSA, TÜV
VLP270F	1,000	—	10,000	W27	UL, CSA, TÜV
<b>VTP</b>					
VTP110F	1,000	—	10,000	—	UL, CSA, TÜV
VTP170F	1,000	—	10,000	V17	UL, CSA, TÜV
VTP170XSF	1,000	—	10,000	V17	UL, CSA, TÜV
VTP175F	1,000	—	10,000	V1X	UL, CSA, TÜV
VTP175LF	1,000	—	10,000	V1X	UL, CSA, TÜV
VTP210GF	1,000	—	10,000	V21	UL, CSA, TÜV
VTP210SF	1,000	—	10,000	V21	UL, CSA, TÜV
<b>120°C Typical Activation</b>					
<b>MXP</b>					
MXP180	2,000	—	48,000	—	UL, CSA, TÜV
MXP190BB	2,000	—	48,000	—	UL, CSA, TÜV
MXP250K	2,000	—	48,000	—	UL, CSA, TÜV
MXP270	2,000	—	48,000	—	UL
MXP310	2,000	—	48,000	—	UL
MXP370BD	2,000	—	48,000	—	UL, CSA, TÜV
<b>120°C Typical Activation</b>					
<b>MGP</b>					
MGP450	2,000	—	48,000	—	—
MGP500	2,000	—	48,000	—	UL, TÜV

# PolySwitch Resettable Devices

## Strap Battery Devices

Table B6 — Packaging and Marking Information/Agency Recognition

(Cont'd)

Part Number	Bag Quantity	Tape and Reel Quantity	Standard Package Quantity	Part Marking	Agency Recognition
<b>125°C Typical Activation SRP</b>					
SRP120F	1,000	—	10,000	120	UL, CSA, TÜV
SRP175F	2,000	—	10,000	175	UL, CSA, TÜV
SRP200F	1,000	—	10,000	200	UL, CSA, TÜV
SRP350F	500	—	10,000	350	UL, CSA, TÜV
SRP420F	500	—	10,000	420	UL, CSA, TÜV
<b>LR4</b>					
LR4-190F	2,000	—	10,000	E19	UL, CSA, TÜV
LR4-260F	1,000	—	10,000	E26	UL, CSA, TÜV
LR4-380F	1,000	—	10,000	E38	UL, CSA, TÜV
LR4-380XF	1,000	—	10,000	E38	UL, CSA, TÜV
LR4-450F	1,000	—	10,000	E45	UL, CSA, TÜV
LR4-550F	1,000	—	10,000	E55	UL, CSA, TÜV
LR4-600F	1,000	—	10,000	E60	UL, CSA, TÜV
LR4-600XF	1,000	—	10,000	E60	UL, CSA, TÜV
LR4-730F	1,000	—	10,000	E73	UL, CSA, TÜV
LR4-900F	500	—	10,000	E90	UL, CSA, TÜV
LR4-1300SSF	250	—	10,000	EX3	UL, CSA, TÜV

## Agency Recognition

UL	File # E74889
CSA	File # 78165C
TÜV	Certificate Number Available on Request

## Installation Guidelines for the Strap Family

- PPTC devices operate by thermal expansion of the conductive polymer. If devices are placed under pressure or installed in spaces that would prevent thermal expansion, they may not properly protect against damage caused by fault conditions. Designs must be selected in such a manner that adequate space is maintained over the life of the product.
- Twisting, bending, or placing the PPTC device in tension will decrease the ability of the device to protect against damage caused by electrical faults. No residual force should remain on device after installation. Mechanical damage to the PPTC device may affect device performance and should be avoided.
- Chemical contamination of PPTC devices should be avoided. Certain greases, solvents, hydraulic fluids, fuels, industrial cleaning agents, volatile components of adhesives, silicones, and electrolytes can have an adverse effect on device performance.
- PPTC strap devices are intended to be resistance welded to battery cells or to pack interconnect straps, yet some precautions must be taken when doing so. In order for the PPTC device to exhibit its specified performance, weld placement should be a minimum of 2mm from the edge of the PPTC device, weld splatter must not touch the PPTC device, and welding conditions must not heat the PPTC device above its maximum operating temperature.
- PPTC strap devices are not intended for applications where reflow onto flex circuits or rigid circuit boards is required.
- The polyester tape on PPTC strap devices is intended for marking and identification purposes only, not for electrical insulation.
- The coating on MXP and MGP devices is intended to prevent oxidization/aging of the devices. Damaging the coating or causing the coating to delaminate can have negative effects on device performance and should be avoided.
- MXP and MGP devices have a small PPTC chip size and therefore have weaker peel strength between the polymer and Ni-foil of the chip. Excessive mechanical force to the device may cause delamination of Ni-foil from the polymer.

# PolySwitch Resettable Devices

## Strap Battery Devices

### Part Numbering System

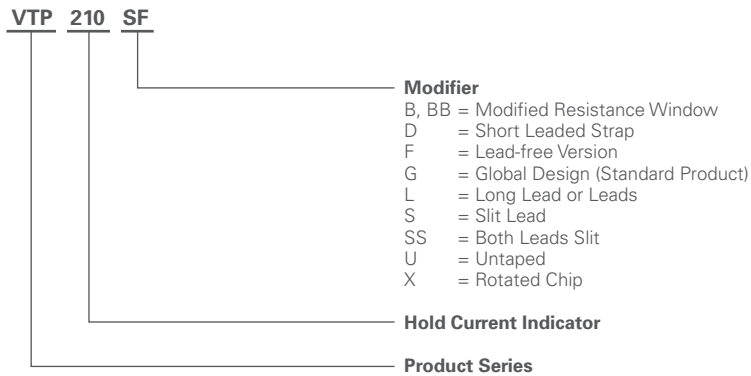

#### **Warning :**

- Users should independently evaluate the suitability of and test each product selected for their own application.
- Operation beyond the maximum ratings or improper use may result in device damage and possible electrical arcing and flame.
- These devices are intended for protection against damage caused by occasional overcurrent or overtemperature fault conditions and should not be used when repeated fault conditions or prolonged trip events are anticipated.
- Contamination of the PPTC material with certain silicone-based oils or some aggressive solvents can adversely impact the performance of the devices.
- Device performance can be impacted negatively if devices are handled in a manner inconsistent with recommended electronic, thermal, and mechanical procedures for electronic components.
- PPTC devices are not recommended for installation in applications where the device is constrained such that its PTC properties are inhibited, for example in rigid potting materials or in rigid housings, which lack adequate clearance to accommodate device expansion.
- Operation in circuits with a large inductance can generate a circuit voltage ( $Ldi/dt$ ) above the rated voltage of the device.

#### **Notice:**

Information furnished is believed to be accurate and reliable. However, users should independently evaluate the suitability of and test each product selected for their own applications. Littelfuse products are not designed for, and shall not be used for, any purpose (including, without limitation, military, aerospace, medical, life-saving, life-sustaining or nuclear facility applications, devices intended for surgical implant into the body, or any other application in which the failure or lack of desired operation of the product may result in personal injury, death, or property damage) other than those expressly set forth in applicable Littelfuse product documentation. Warranties granted by Littelfuse shall be deemed void for products used for any purpose not expressly set forth in applicable Littelfuse documentation. Littelfuse shall not be liable for any claims or damages arising out of products used in applications not expressly intended by Littelfuse as set forth in applicable Littelfuse documentation. The sale and use of Littelfuse products is subject to Littelfuse Terms and Conditions of Sale, unless otherwise agreed by Littelfuse.