



# Dual Temperature-Controlled Resistors with Three Monitors

DS1858

## General Description

The DS1858 dual temperature-controlled nonvolatile (NV) variable resistors with three monitors consists of two 50kΩ 256-position linear variable resistors, three analog monitor inputs (MON1, MON2, MON3), and a direct-to-digital temperature sensor. The device provides an ideal method for setting and temperature-compensating bias voltages and currents in control applications using minimal circuitry. The variable resistor settings are stored in EEPROM memory and can be accessed over the 2-wire serial bus.

## Applications

- Optical Transceivers
- Optical Transponders
- Instrumentation and Industrial Controls
- RF Power Amps
- Diagnostic Monitoring

## Features

- ◆ Five Total Monitored Channels (Temperature, VCC, MON1, MON2, MON3)
- ◆ Three External Analog Inputs (MON1, MON2, MON3)
- ◆ Internal Direct-to-Digital Temperature Sensor
- ◆ Two 50kΩ, Linear, 256-Position, Nonvolatile Temperature-Controlled Variable Resistors
- ◆ Resistor Settings Changeable Every 2°C
- ◆ Access to Monitoring and ID Information Configurable with Separate Device Addresses
- ◆ 2-Wire Serial Interface
- ◆ Two Buffers with TTL/CMOS-Compatible Inputs and Open-Drain Outputs
- ◆ Operates from a 3.3V or 5V Supply
- ◆ SFF-8472 Compatible

## Typical Operating Circuit

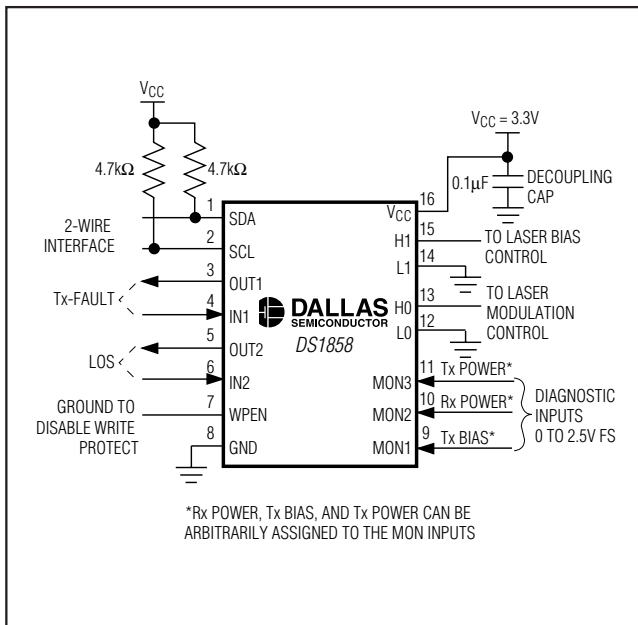

## Ordering Information

PART	TEMP RANGE	PIN-PACKAGE
DS1858E-050	-40°C to +95°C	16 TSSOP
DS1858E-050+	-40°C to +95°C	16 TSSOP
DS1858E-050/T&R	-40°C to +95°C	16 TSSOP (Tape-and-Reel)
DS1858B-050	-40°C to +95°C	16-Ball CSBGA

+Denotes lead-free package.

## Pin Configurations

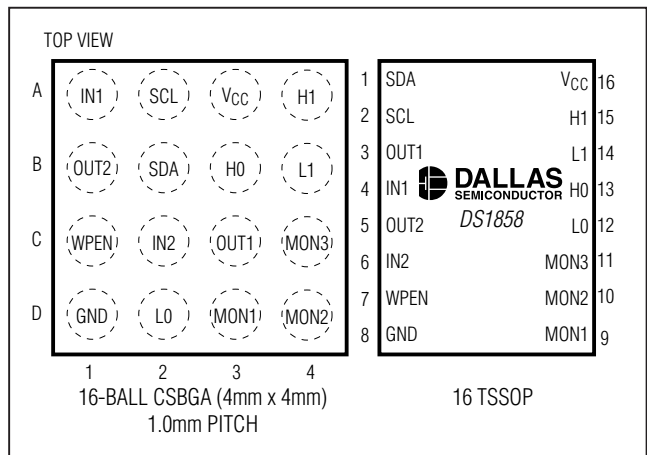

# Dual Temperature-Controlled Resistors with Three Monitors

DS1020

## ABSOLUTE MAXIMUM RATINGS

Voltage on V<sub>CC</sub> Relative to Ground.....-0.5V to +6.0V  
 Voltage on Inputs Relative to Ground\* .....-0.5V to V<sub>CC</sub> + 0.5V  
 Voltage on Resistor Inputs Relative to Ground\* .....-0.5V to V<sub>CC</sub> + 0.5V

Current into Resistors.....5mA  
 Operating Temperature Range .....-40°C to +95°C  
 Programming Temperature Range .....0°C to +70°C  
 Storage Temperature Range .....-55°C to +125°C  
 Soldering Temperature .....See IPC/JEDEC

\*Not to exceed 6.0V.

Stresses beyond those listed under "Absolute Maximum Ratings" may cause permanent damage to the device. These are stress ratings only, and functional operation of the device at these or any other conditions beyond those indicated in the operational sections of the specifications is not implied. Exposure to absolute maximum rating conditions for extended periods may affect device reliability.

## RECOMMENDED DC OPERATING CONDITIONS

(T<sub>A</sub> = -40°C to +95°C, unless otherwise noted.)

PARAMETER	SYMBOL	CONDITIONS	MIN	TYP	MAX	UNITS
Supply Voltage	V <sub>CC</sub>	(Note 1)	3.0		5.5	V
Input Logic 1 (SDA, SCL, WPEN)	V <sub>IH</sub>	(Note 2)	0.7 x V <sub>CC</sub>		V <sub>CC</sub> + 0.3	V
Input Logic 0 (SDA, SCL, WPEN)	V <sub>IL</sub>	(Note 2)	-0.3		0.3 x V <sub>CC</sub>	V
Resistor Inputs (L0, L1, H0, H1)			-0.3		V <sub>CC</sub> + 0.3	V
Resistor Current	I <sub>RES</sub>		-3		+3	mA
Input Logic Levels (IN1, IN2)	V <sub>IH</sub>	Input logic 1	1.5			V
	V <sub>IL</sub>	Input logic 0			0.9	

## DC ELECTRICAL CHARACTERISTICS

(V<sub>CC</sub> = 3.0V to 5.5V, T<sub>A</sub> = -40°C to +95°C, unless otherwise noted.)

PARAMETER	SYMBOL	CONDITIONS	MIN	TYP	MAX	UNITS
Supply Current	I <sub>CC</sub>	(Note 3)		1	2	mA
Input Leakage	I <sub>IL</sub>		-1		+1	μA
Input Current each I/O Pin		0.4 x V <sub>CC</sub> < V <sub>I/O</sub> < 0.9 x V <sub>CC</sub>	-10		+10	μA
Low-Level Output Voltage (SDA)	V <sub>OL1</sub>	3mA sink current	0		0.4	V
	V <sub>OL2</sub>	6mA sink current	0		0.6	
Full-Scale Input (MON1, MON2, MON3)		(Note 4)	2.4875	2.5	2.5125	V
Full-Scale V <sub>CC</sub> Monitor		(Note 5)	6.5208	6.5536	6.5864	V
I/O Capacitance	C <sub>I/O</sub>				10	pF
WPEN Pullup	R <sub>WPEN</sub>		40	65	100	kΩ
OUT1, OUT2 Voltage	V <sub>OL1</sub>	3mA sink current	0		0.4	V
	V <sub>OL2</sub>	6mA sink current	0		0.6	
Digital Power-On Reset	POD		1.0		2.2	V
Analog Power-On Reset	POA		2.0		2.6	V

# Dual Temperature-Controlled Resistors with Three Monitors

DS1858

## ANALOG RESISTOR CHARACTERISTICS

(V<sub>CC</sub> = 3.0V to 5.5V, T<sub>A</sub> = -40°C to +95°C, unless otherwise noted.)

PARAMETER	SYMBOL	CONDITIONS	MIN	TYP	MAX	UNITS
Position 00h Resistance		T <sub>A</sub> = +25°C	0.7	1.0	1.25	kΩ
Position FFh Resistance		T <sub>A</sub> = +25°C	40	50	60	kΩ
Absolute Linearity		(Note 6)	-2		+2	LSB
Relative Linearity		(Note 7)	-1		+1	LSB
Temperature Coefficient		(Note 8)		50		ppm/°C

## ANALOG VOLTAGE MONITORING

(V<sub>CC</sub> = 3.0V to 5.5V, T<sub>A</sub> = -40°C to +95°C, unless otherwise noted.)

PARAMETER	SYMBOL	CONDITIONS	MIN	TYP	MAX	UNITS
Input Resolution	ΔVMON			610		μV
Supply Resolution	ΔV <sub>CC</sub>			1.6		mV
Input/Supply Accuracy	Acc			0.25	0.5	% FS (full scale)
Update Rate for MON1, MON2, MON3, Temp, or V <sub>CC</sub>	t <sub>frame</sub>			25	36	ms

## DIGITAL THERMOMETER

(V<sub>CC</sub> = 3.0V to 5.5V, T<sub>A</sub> = -40°C to +95°C, unless otherwise noted.)

PARAMETER	SYMBOL	CONDITIONS	TYP	MAX	UNITS
Thermometer Error	T <sub>ERR</sub>	-40°C to +95°C		±3.0	°C

# Dual Temperature-Controlled Resistors with Three Monitors

DS90C03

## AC ELECTRICAL CHARACTERISTICS

( $V_{CC} = 3.0V$  to  $5.5V$ ,  $T_A = -40^{\circ}C$  to  $+95^{\circ}C$ , unless otherwise noted.)

PARAMETER	SYMBOL	CONDITIONS	MIN	TYP	MAX	UNITS
SCL Clock Frequency	$f_{SCL}$	Fast mode (Note 9)	0		400	kHz
		Standard mode (Note 9)	0		100	
Bus Free Time Between STOP and START Condition	$t_{BUF}$	Fast mode (Note 9)	1.3			$\mu s$
		Standard mode (Note 9)	4.7			
Hold Time (Repeated) START Condition	$t_{HD:STA}$	Fast mode (Notes 9, 10)	0.6			$\mu s$
		Standard mode (Notes 9, 10)	4.0			
Low Period of SCL Clock	$t_{LOW}$	Fast mode (Note 9)	1.3			$\mu s$
		Standard mode (Note 9)	4.7			
High Period of SCL Clock	$t_{HIGH}$	Fast mode (Note 9)	0.6			$\mu s$
		Standard mode (Note 9)	4.0			
Data Hold Time	$t_{HD:DAT}$	Fast mode (Notes 9, 11, 12)	0		0.9	$\mu s$
		Standard mode (Notes 9, 11, 12)	0			
Data Setup Time	$t_{SU:DAT}$	Fast mode (Note 9)	100			ns
		Standard mode (Note 9)	250			
Start Setup Time	$t_{SU:STA}$	Fast mode (Note 9)	0.6			$\mu s$
		Standard mode (Note 9)	4.7			
Rise Time of Both SDA and SCL Signals	$t_R$	Fast mode (Note 13)	$20 + 0.1C_B$		300	ns
		Standard mode (Note 13)	$20 + 0.1C_B$		1000	
Fall Time of Both SDA and SCL Signals	$t_F$	Fast mode (Note 13)	$20 + 0.1C_B$		300	ns
		Standard mode (Note 13)	$20 + 0.1C_B$		300	
Setup Time for STOP Condition	$t_{SU:STO}$	Fast mode	0.6			$\mu s$
		Standard mode	4.0			
Capacitive Load for Each Bus Line	$C_B$	(Note 13)			400	pF
EEPROM Write Time	$t_W$	(Note 14)		10		ms

**Note 1:** All voltages are referenced to ground.

**Note 2:** I/O pins of fast-mode devices must not obstruct the SDA and SCL lines if  $V_{CC}$  is switched off.

**Note 3:** SDA and SCL are connected to  $V_{CC}$  and all other input signals are connected to well-defined logic levels.

**Note 4:** The maximum voltage the MON inputs will read is approximately 2.5V, even if the voltage on the inputs is greater than 2.5V.

**Note 5:** This voltage is defining the maximum range of the analog-to-digital converter voltage and not the maximum  $V_{CC}$  voltage.

**Note 6:** Absolute linearity is the difference of measured value from expected value at DAC position. The expected value is a straight line from measured minimum position to measured maximum position.

**Note 7:** Relative linearity is the deviation of an LSB DAC setting change vs. the expected LSB change. The expected LSB change is the slope of the straight line from measured minimum position to measured maximum position.

**Note 8:** See the *Typical Operating Characteristics*.

**Note 9:** A fast-mode device can be used in a standard-mode system, but the requirement  $t_{SU:DAT} > 250ns$  must then be met. This is automatically the case if the device does not stretch the LOW period of the SCL signal. If such a device does stretch the LOW period of the SCL signal, it must output the next data bit to the SDA line  $t_{RMAX} + t_{SU:DAT} = 1000ns + 250ns = 1250ns$  before the SCL line is released.

# Dual Temperature-Controlled Resistors with Three Monitors

## AC ELECTRICAL CHARACTERISTICS (continued)

( $V_{CC} = 3.0V$  to  $5.5V$ ,  $T_A = -40^{\circ}C$  to  $+95^{\circ}C$ , unless otherwise noted.)

**Note 10:** After this period, the first clock pulse is generated.

**Note 11:** The maximum  $t_{HD:DAT}$  only has to be met if the device does not stretch the LOW period ( $t_{LOW}$ ) of the SCL signal.

**Note 12:** A device must internally provide a hold time of at least 300ns for the SDA signal (see the  $V_{IH\ MIN}$  of the SCL signal) in order to bridge the undefined region of the falling edge of SCL.

**Note 13:**  $C_B$ —total capacitance of one bus line, timing referenced to  $0.9 \times V_{CC}$  and  $0.1 \times V_{CC}$ .

**Note 14:** EEPROM write begins after a STOP condition occurs.

## Typical Operating Characteristics

( $V_{CC} = 5.0V$ ,  $T_A = +25^{\circ}C$ , unless otherwise noted.)

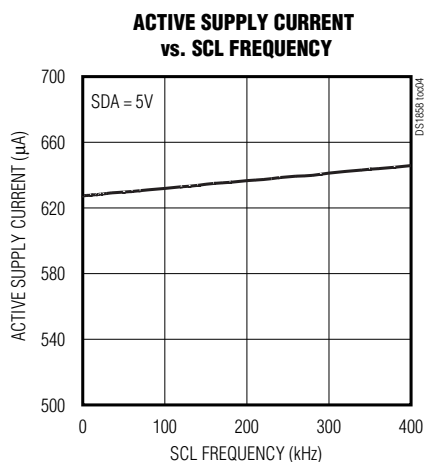
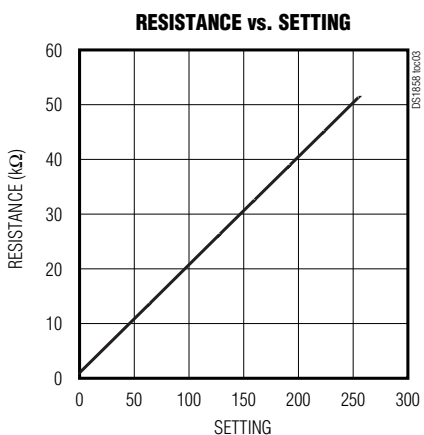
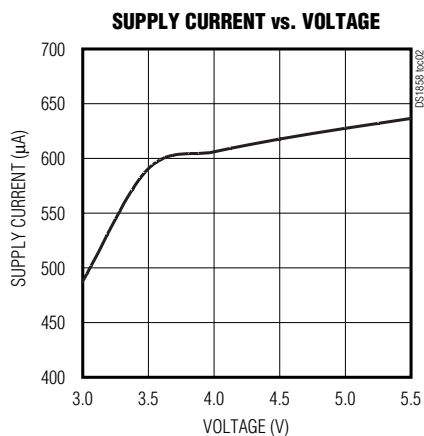
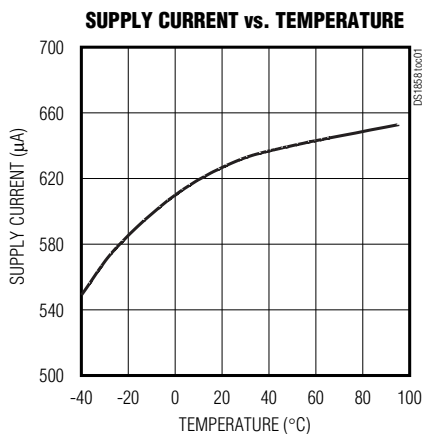

# Dual Temperature-Controlled Resistors with Three Monitors

## Typical Operating Characteristics (continued)

( $V_{CC} = 5.0V$ ,  $T_A = +25^\circ C$ , unless otherwise noted.)

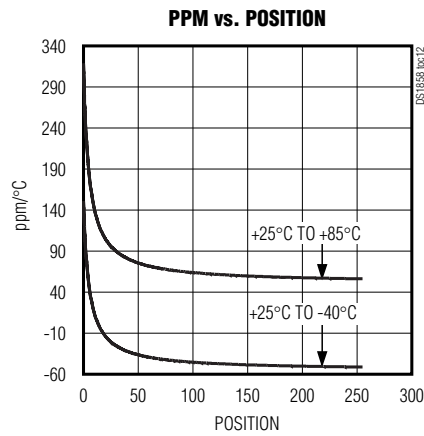
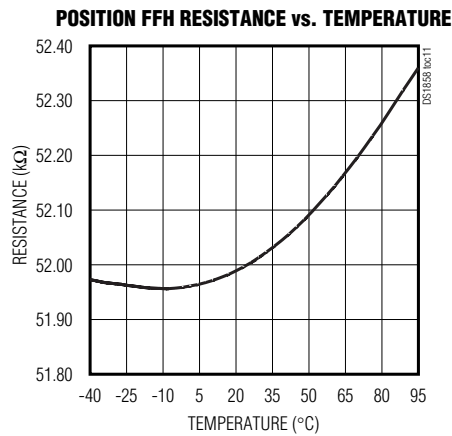
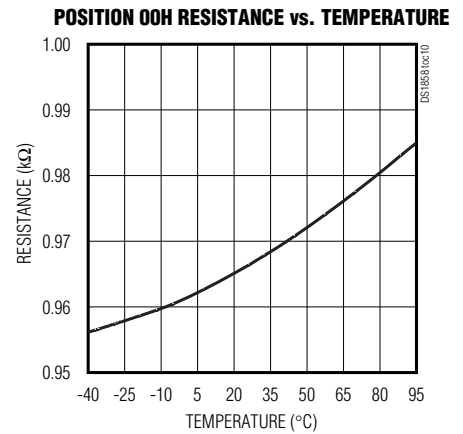
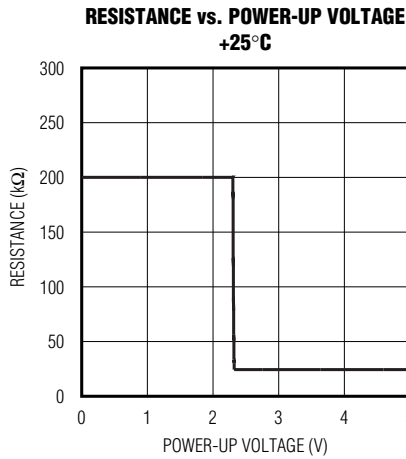
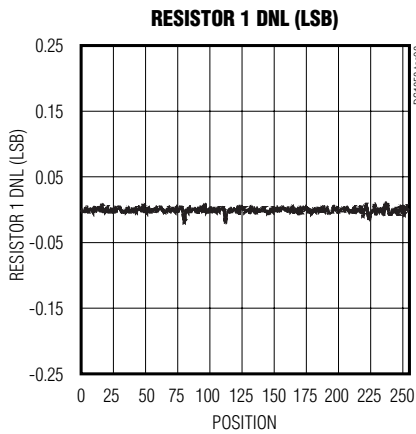
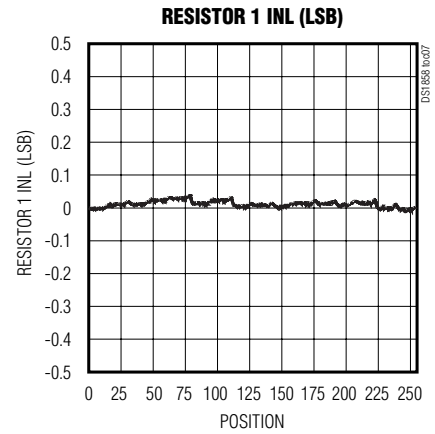
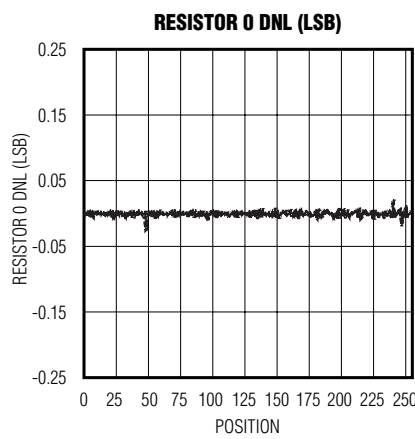
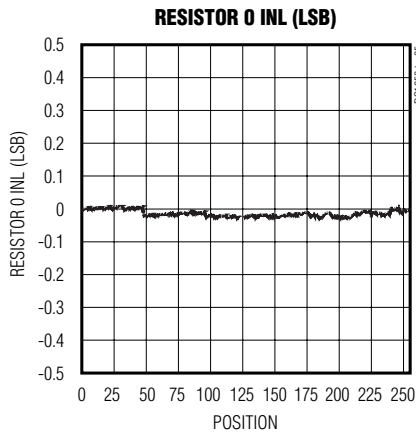

# Dual Temperature-Controlled Resistors with Three Monitors

## Pin Descriptions

**DS1858**

PIN	BALL	NAME	FUNCTION
1	B2	SDA	2-Wire Serial Data I/O Pin. This pin is for serial data transfer to and from the device.
2	A2	SCL	2-Wire Serial Clock Input. The serial clock input is used to clock data into and out of the device.
3	C3	OUT1	Open-Drain Buffer Output
4	A1	IN1	TTL/CMOS-Compatible Input to Buffer
5	B1	OUT2	Open-Drain Buffer Output
6	C2	IN2	TTL/CMOS-Compatible Input to Buffer
7	C1	WPEN	Write Protect Enable. The device is not write protected if WPEN is connected to ground. This pin has an internal pullup (R <sub>WPEN</sub> ). See Table 6.
8	D1	GND	Ground
9	D3	MON1	External Analog Input
10	D4	MON2	External Analog Input
11	C4	MON3	External Analog Input
12	D2	L0	Low-End Resistor 0 Terminal. It is not required that the low-end terminals be connected to a potential less than the high-end terminals of the corresponding resistor. Voltage applied to any of the resistor terminals cannot exceed the power-supply voltage, V <sub>CC</sub> , or go below ground.
13	B3	H0	High-End Resistor 0 Terminal. It is not required that the high-end terminals be connected to a potential greater than the low-end terminals of the corresponding resistor. Voltage applied to any of the resistor terminals cannot exceed the power-supply voltage, V <sub>CC</sub> , or go below ground.
14	B4	L1	Low-End Resistor 1 Terminal
15	A4	H1	High-End Resistor 1 Terminal
16	A3	V <sub>CC</sub>	Supply Voltage

### Detailed Description

The user can read the registers that monitor the V<sub>CC</sub>, MON1, MON2, MON3, and temperature analog signals. After each signal conversion, a corresponding bit is set that can be monitored to verify that a conversion has occurred. The signals also have alarm flags that notify the user when the signals go above or below the user-defined value. Interrupts can also be set for each signal.

The position values of each resistor can be independently programmed. The user can assign a unique value to each resistor for every 2°C increment over the -40°C to +102°C range.

Two buffers are provided to convert logic-level inputs into open-drain outputs. Typically these buffers are used to implement transmit (Tx) fault and loss-of-signal (LOS) functionality. Additionally, OUT1 can be asserted in the event that one or more of the monitored values go beyond user-defined limits.

# Dual Temperature-Controlled Resistors with Three Monitors

DS18B20

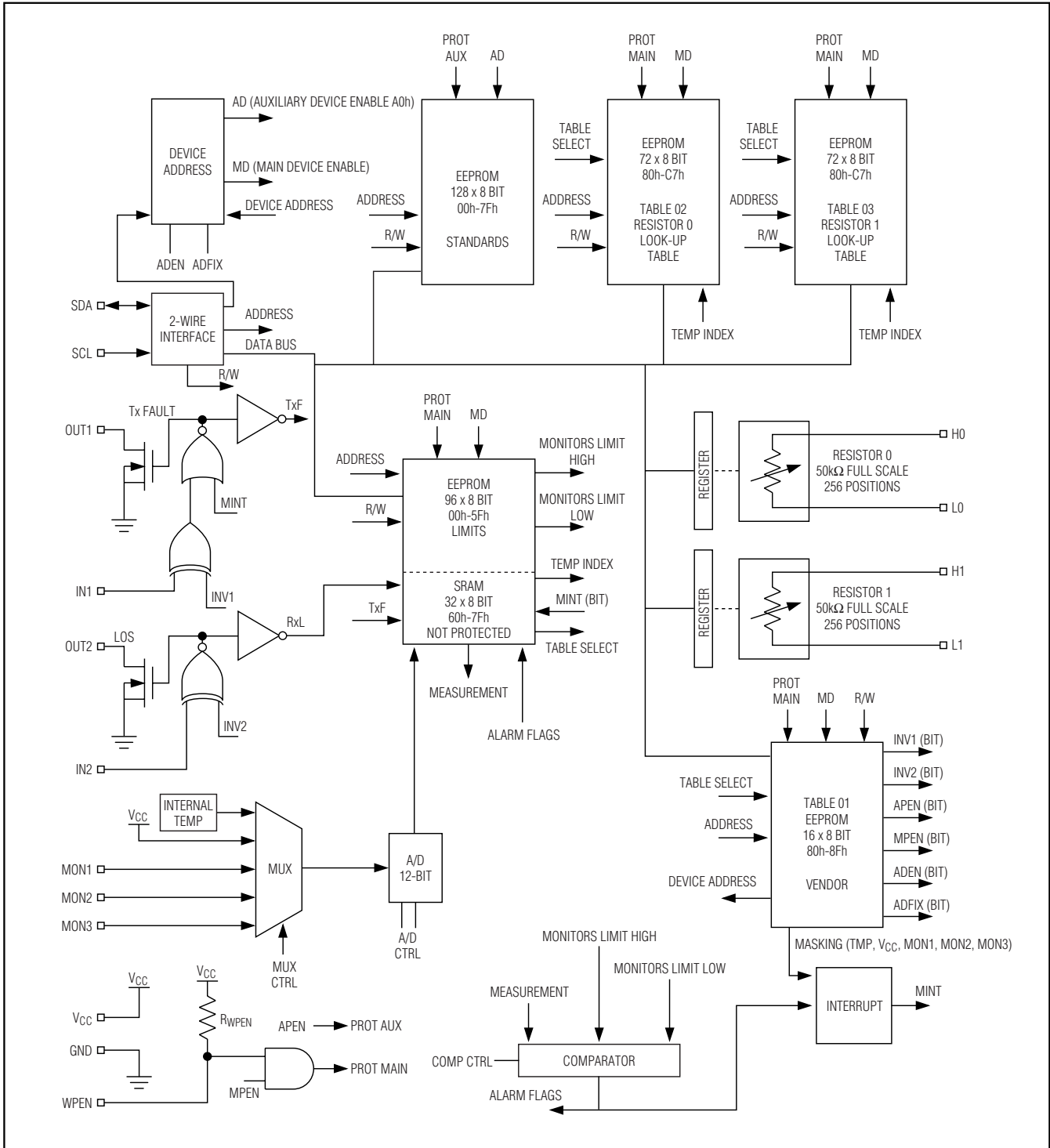

Figure 1. DS18B20 Block Diagram



# Dual Temperature-Controlled Resistors with Three Monitors

**Table 1. Scales for Monitor Channels**

SIGNAL	+FS SIGNAL	+FS (hex)	-FS SIGNAL	-FS (hex)
Temperature	127.996°C	7FFF	-128°C	8000
V <sub>CC</sub>	6.55V	FFFF	0V	0000
MON1	2.5V	FFFF	0V	0000
MON2	2.5V	FFFF	0V	0000
MON3	2.5V	FFFF	0V	0000

**Table 2. Signal Comparison**

SIGNAL	FORMAT
V <sub>CC</sub>	Unsigned
MON1	Unsigned
MON2	Unsigned
MON3	Unsigned
Temperature	Two's complement

### Monitored Signals

Each signal (V<sub>CC</sub>, MON1, MON2, MON3, and temperature) is available as a 16-bit value with 12-bit accuracy (left-justified) over the serial bus. See Table 1 for signal scales and Table 2 for signal format. The four LSBs should be masked when calculating the value.

The signals are updated every frame rate (t<sub>frame</sub>) in a round-robin fashion.

The comparison of all five signals with the high and low user-defined values are done automatically. The corresponding flags are set to 1 within a specified time of the occurrence of an out-of-limit condition.

### Calculating Signal Values

The LSB = 100μV for V<sub>CC</sub>, and the LSB = 38.147μV for the MON signals.

### Monitor/V<sub>CC</sub> Bit Weights

MSB	2 <sup>15</sup>	2 <sup>14</sup>	2 <sup>13</sup>	2 <sup>12</sup>	2 <sup>11</sup>	2 <sup>10</sup>	2 <sup>9</sup>	2 <sup>8</sup>
LSB	2 <sup>7</sup>	2 <sup>6</sup>	2 <sup>5</sup>	2 <sup>4</sup>	2 <sup>3</sup>	2 <sup>2</sup>	2 <sup>1</sup>	2 <sup>0</sup>

To calculate the value of V<sub>CC</sub>, convert the unsigned 16-bit value to decimal and multiply by 100μV.

### V<sub>CC</sub> Conversion Examples

MSB (BIN)	LSB (BIN)	VOLTAGE (V)
10000000	10000000	3.29
11000000	11111000	4.94

**Table 3. Look-up Table Address for Corresponding Temperature Values**

TEMPERATURE	CORRESPONDING LOOK-UP TABLE ADDRESS
<-40°C	80h
-40°C	80h
-38°C	81h
-36°C	82h
-34°C	83h
—	—
+98°C	C5h
+100°C	C6h
+102°C	C7h
>+102°C	C7h

### Monitor Conversion Example

MSB (BIN)	LSB (BIN)	VOLTAGE (V)
11000000	00000000	1.875
10000000	10000000	1.255

To calculate the value of MON1, MON2, or MON3 convert the unsigned 16-bit value to decimal and multiply by 38.147μV.

To calculate the value of the temperature, treat the two's complement value binary number as an unsigned binary number, then convert to decimal and divide by 256. If the result is greater than or equal to 128, then subtract 256 from the result.

Temperature: high byte: -128°C to +127°C signed; low byte: 1/256°C.

### Temperature Bit Weights

S	2 <sup>6</sup>	2 <sup>5</sup>	2 <sup>4</sup>	2 <sup>3</sup>	2 <sup>2</sup>	2 <sup>1</sup>	2 <sup>0</sup>
2 <sup>-1</sup>	2 <sup>-2</sup>	2 <sup>-3</sup>	2 <sup>-4</sup>	2 <sup>-5</sup>	2 <sup>-6</sup>	2 <sup>-7</sup>	2 <sup>-8</sup>

### Temperature Conversion Examples

MSB (BIN)	LSB (BIN)	TEMPERATURE (°C)
01000000	00000000	64
01000000	00001111	64.059
01011111	00000000	95
11110110	00000000	-10
11011000	00000000	-40

# Dual Temperature-Controlled Resistors with Three Monitors

DS10C020

**Table 4. ADEN Address Configuration**

ADEN (ADDRESS ENABLE)	NO. OF SEPARATE DEVICE ADDRESSES	ADDITIONAL INFORMATION
0	2	See Figure 2
1	1 (Main Device only)	See Figure 3

**Table 5. ADEN and ADFIX Bits**

ADEN	ADFIX	AUXILIARY ADDRESS	MAIN ADDRESS
0	0	A0h	A2h
0	1	A0h	EEPROM (Table 01, 8Ch)
1	0	N/A	A2h
1	1	N/A	EEPROM (Table 01, 8Ch)

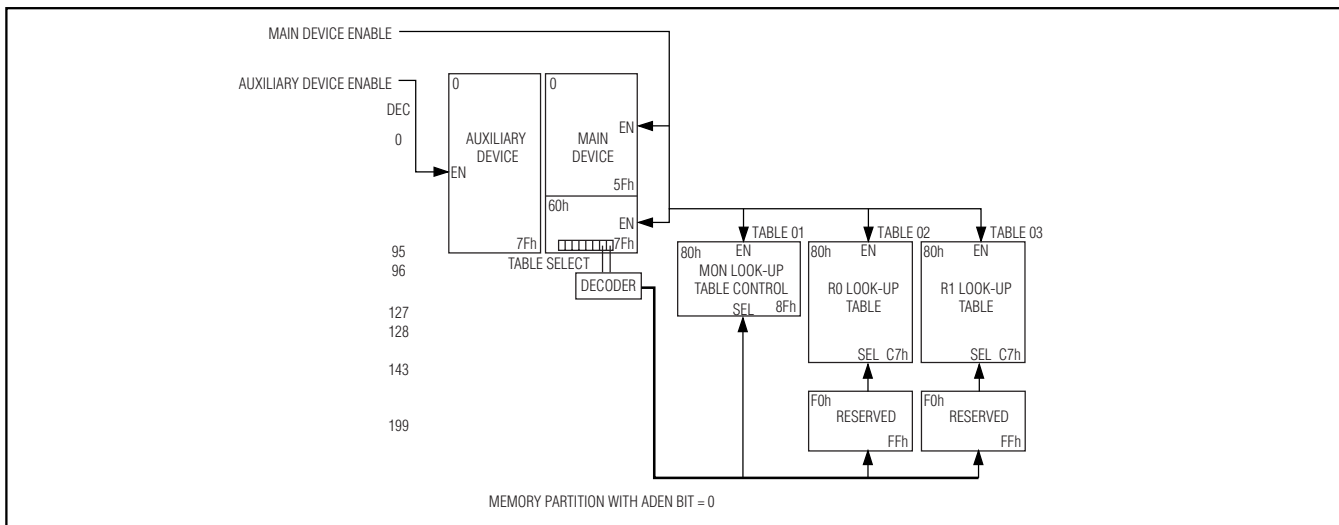

Figure 2. Memory Organization, ADEN = 0

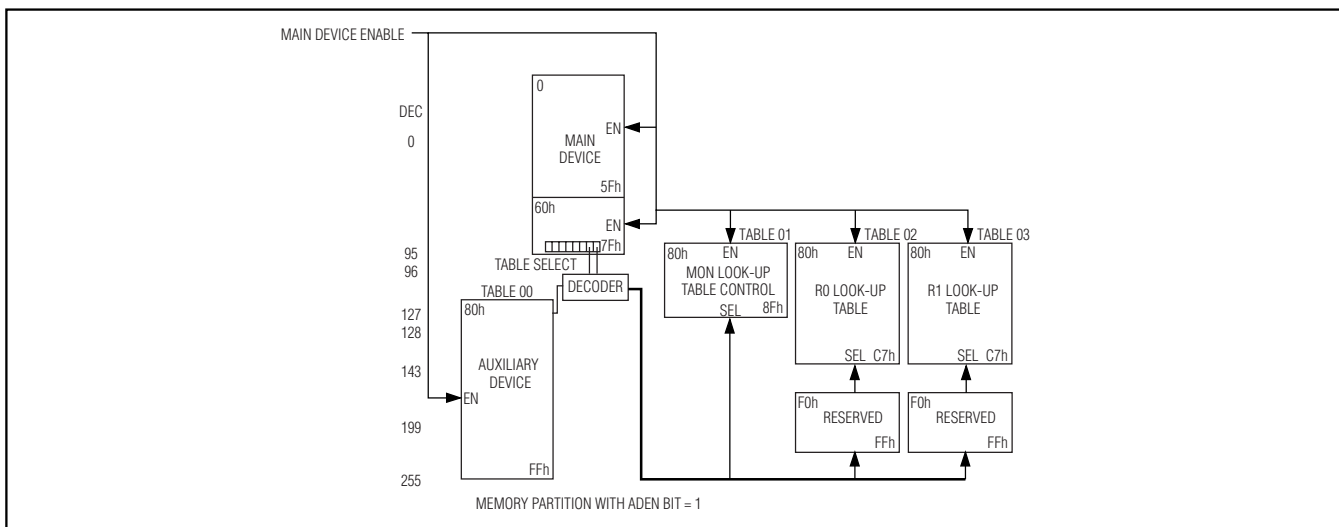

Figure 3. Memory Organization, ADEN = 1

# Dual Temperature-Controlled Resistors with Three Monitors

## Variable Resistors

The value of each variable resistor is determined by a temperature-addressed look-up table, which can assign a unique value (00h to FFh) to each resistor for every 2°C increment over the -40°C to +102°C range (see Table 3). See the *Temperature Conversion* section for more information.

The variable resistors can also be used in manual mode. If the TEN bit equals 0, then the resistors are in manual mode and the temperature indexing is disabled. The user sets the resistors in manual mode by writing to addresses 82h and 83h in Table 01 to control resistors 0 and 1, respectively.

## Memory Description

Main and auxiliary memories can be accessed by two separate device addresses. The Main Device address is A2h (or value in Table 01 byte 8Ch, when ADFIX = 1) and the Auxiliary Device address is A0h. A user option is provided to respond to one or two device addresses. This feature can be used to save component count in SFF applications (Main Device address can be used) or other applications where both GBIC (Auxiliary Device address can be used) and monitoring functions are implemented and two device addresses are needed. The memory blocks are enabled with the corresponding device address. Memory space from 80h and up is accessible only through the Main Device address. This memory is organized as three tables; the desired table can be selected by the contents of memory location 7Fh, Main Device. The Auxiliary Device address has no access to the tables, but the Auxiliary Device address can be mapped into the Main Device's memory space as a fourth table. Device addresses are programmable with two control bits in EEPROM.

ADEN configures memory access to respond to different device addresses (see Tables 4 and 5).

The default device address for EEPROM-generated addresses is A2h.

If the ADEN bit is 1, additional 128 bytes of EEPROM are accessible through the Main Device, selected as Table 00 (see Figure 3). In this configuration, the Auxiliary Device is not accessible. APEN controls the protection of Table 00 regardless of the setting of ADEN.

ADFIX (address fixed) determines whether the Main Device address is determined by an EEPROM byte (Table 01, byte 8Ch, when ADFIX = 1). There can be up to 128 devices sharing a common 2-wire bus, with each device having its own unique device address.

## Memory Protection

Memory access from either device address can be either read/write or read only. Write protection is accomplished by a combination of control bits in EEPROM (APEN and MPEN in configuration register 89h) and a write-protect enable (WPEN) pin. Since the WPEN pin is often not accessible from outside the module, this scheme effectively allows the module to be locked by the manufacturer to prevent accidental writes by the end user.

Separate write protection is provided for the Auxiliary and Main Device address through distinct bits APEN and MPEN. APEN and MPEN are bits from configuration register 89h, Table 01. Due to the location, the APEN and MPEN bits can only be written through the Main Device address. The control of write privileges through the Auxiliary Device address is dependent on the value of APEN. Care should be taken with the setting of MPEN, once set to a 1, assuming WPEN is high, access through the Main Device is thereafter denied unless WPEN is taken to a low level. By this means inadvertent end-user write access can be denied.

Main Device address space 60h to 7Fh is SRAM and is not write protected by APEN, MPEN, or WPEN. For example, the user may reset flags set by the device. Bytes designated as "Reserved" may be used as scratchpad, but they will not be stored in a power cycle because of their volatility. These bytes are reserved for added functionality in future versions of this device. Note that in single device mode (ADEN bit = 1), APEN determines the protection level of Table 00, independent of WPEN.

The write-protect operation, for both Main and Auxiliary Devices, is summarized in Tables 6 and 7.

**Table 6. Main Device**

WPEN	MPEN	PROTECT MAIN
0	X	No
X	0	No
1	1	Yes

**Table 7. Auxiliary Device**

APEN	WPEN	PROTECT AUXILIARY
0	X	No
1	X	Yes

# Dual Temperature-Controlled Resistors with Three Monitors

## Register Map

A description of the registers is below. The registers are read only (R) or read/write (R/W). The R/W registers are writable only if write protect has not been asserted (see the *Memory Description* section).

### Auxiliary Device

MEMORY LOCATION (hex)	EEPROM/SRAM	R/W	DEFAULT SETTING (hex)	NAME OF LOCATION	FUNCTION
00 to 7F	EEPROM	R/W	00	Standards Data	—

### Main Device

MEMORY LOCATION (hex)	EEPROM/SRAM	R/W	DEFAULT SETTING (hex)	NAME OF LOCATION	FUNCTION
00 to 01	EEPROM	R/W	00	TMPlimhi (MSB to LSB)	Contains upper limit settings for temperature. If the limit is violated, a flag in Main Device byte 70h is set.
02 to 03	EEPROM	R/W	00	TMPlimlo (MSB to LSB)	Contains lower limit settings for temperature. If the limit is violated, a flag in Main Device byte 70h is set.
04 to 07	EEPROM	R	00	Reserved	—
08 to 09	EEPROM	R/W	00	VCClimhi (MSB to LSB)	Contains upper limit settings for V <sub>CC</sub> . If the limit is violated, a flag in Main Device byte 70h is set.
0A to 0B	EEPROM	R/W	00	VCClimlo (MSB to LSB)	Contains lower limit settings for V <sub>CC</sub> . If the limit is violated, a flag in Main Device byte 70h is set.
0C to 0F	EEPROM	—	00	Reserved	—
10 to 11	EEPROM	R/W	00	MON1limhi (MSB to LSB)	Contains upper limit settings for MON1. If the limit is violated, a flag in Main Device byte 70h is set.
12 to 13	EEPROM	R/W	00	MON1limlo (MSB to LSB)	Contains lower limit settings for MON1. If the limit is violated, a flag in Main Device byte 70h is set.
14 to 17	EEPROM	—	00	Reserved	—
18 to 19	EEPROM	R/W	00	MON2limhi (MSB to LSB)	Contains upper limit settings for MON2. If the limit is violated, a flag in Main Device byte 70h is set.
1A to 1B	EEPROM	R/W	00	MON2limlo (MSB to LSB)	Contains lower limit settings for MON2. If the limit is violated, a flag in Main Device byte 70h is set.
1C to 1F	EEPROM	—	00	Reserved	—

**Note:** SRAM defaults are power-on defaults. EEPROM defaults are factory defaults.

# Dual Temperature-Controlled Resistors with Three Monitors

**DS1858**

## Main Device (continued)

MEMORY LOCATION (hex)	EEPROM/ SRAM	R/W	DEFAULT SETTING (hex)	NAME OF LOCATION	FUNCTION
20 to 21	EEPROM	R/W	00	MON3limhi (MSB to LSB)	Contains upper limit settings for MON3. If the limit is violated, a flag in Main Device byte 71h is set.
22 to 23	EEPROM	R/W	00	MON3limhi (MSB to LSB)	Contains lower limit settings for MON3. If the limit is violated, a flag in Main Device byte 71h is set.
24 to 5F	EEPROM	—	00	Reserved	—
60 to 61	SRAM	R	—	Measured TMP (MSB to LSB)	Digitized measured value for temperature. See Table 1.
62 to 63	SRAM	R	—	Measured V <sub>CC</sub> (MSB to LSB)	Digitized measured value for V <sub>CC</sub> . See Table 1.
64 to 65	SRAM	R	—	Measured MON1 (MSB to LSB)	Digitized measured value for MON1. See Table 1.
66 to 67	SRAM	R	—	Measured MON2 (MSB to LSB)	Digitized measured value for MON2. See Table 1.
68 to 69	SRAM	R	—	Measured MON3 (MSB to LSB)	Digitized measured value for MON3. See Table 1.
6A to 6D	SRAM	R	—	Reserved	—
6E	SRAM	—	—	Logic states	—
Bit 7	—	R	X	HIZSTA	Resistor status bit. A high indicates that both resistors are in high-impedance mode. A low indicates that both resistors are operating normally.
6	—	R/W	0	HIZCO	Resistor control bit. Setting this bit high causes both resistors to go into a high-impedance state.
5	—	—	X	X	—
4	—	—	X	X	—
2	—	R	X	TXF	This status bit is high when OUT1 is high assuming there is an external pullup resistor on OUT1.
3	—	—	X	X	—
1	—	R	X	RXL	This status bit is high when OUT2 is high assuming there is an external pullup resistor on OUT2.
0	—	R	X	RDYB	This status bit goes high when V <sub>CC</sub> has fallen below the POA level.

# Dual Temperature-Controlled Resistors with Three Monitors

DS10C030

## Main Device (continued)

MEMORY LOCATION (hex)	EEPROM/ SRAM	R/W	DEFAULT SETTING (hex)	NAME OF LOCATION	FUNCTION
6F	SRAM	—	—	Conversion updates	—
Bit 7	—	R/W	0	TAU	This bit goes high after a temperature and address update has occurred for the corresponding measurement in bytes 60h to 61h. This bit can be written to a 0 by the user and monitored to verify that a conversion has occurred.
6	—	R/W	0	V <sub>CC</sub> U	This bit goes high after a V <sub>CC</sub> update has occurred for the corresponding measurement in bytes 62h to 63h. This bit can be written to a 0 by the user and monitored to verify that a conversion has occurred.
5	—	R/W	0	MON1U	This bit goes high after a MON1 update has occurred for the corresponding measurement in bytes 64h to 65h. This bit can be written to a 0 by the user and monitored to verify that a conversion has occurred.
4	—	R/W	0	MON2U	This bit goes high after a MON2 update has occurred for the corresponding measurement in bytes 66h to 67h. This bit can be written to a 0 by the user and monitored to verify that a conversion has occurred.
3	—	—	0	MON3U	This bit goes high after a MON3 update has occurred for the corresponding measurement in bytes 68h to 69h. This bit can be written to a 0 by the user and monitored to verify that a conversion has occurred.
2	—	—	0	0	—
1	—	—	0	X	—
0	—	—	0	X	—
70	SRAM	R	—	Alarm flags	—
Bit 7	—	—	—	TMP <sub>hi</sub>	This alarm flag goes high when the upper limit of the temperature setting is violated.
6	—	—	—	TMP <sub>lo</sub>	This alarm flag goes high when the lower limit of the temperature setting is violated.
5	—	—	—	V <sub>CC</sub> hi	This alarm flag goes high when the upper limit of the V <sub>CC</sub> setting is violated.

# Dual Temperature-Controlled Resistors with Three Monitors

**DS1858**

## Main Device (continued)

MEMORY LOCATION (hex)	EEPROM/ SRAM	R/W	DEFAULT SETTING (hex)	NAME OF LOCATION	FUNCTION
4	—	—	—	V <sub>CClo</sub>	This alarm flag goes high when the lower limit of the V <sub>CC</sub> setting is violated.
3	—	—	—	MON1hi	This alarm flag goes high when the upper limit of the MON1 setting is violated.
2	—	—	—	MON1lo	This alarm flag goes high when the lower limit of the MON1 setting is violated.
1	—	—	—	MON2hi	This alarm flag goes high when the upper limit of the MON2 setting is violated.
0	—	—	—	MON2lo	This alarm flag goes high when the lower limit of the MON2 setting is violated.
71	SRAM	R	—	Alarm flags	—
Bit 7	—	—	—	MON3hi	This alarm flag goes high when the upper limit of the MON3 setting is violated.
6	—	—	—	MON3lo	This alarm flag goes high when the lower limit of the MON3 setting is violated.
5	—	—	—	X	—
4	—	—	—	X	—
3	—	—	—	X	—
2	—	—	—	X	—
1	—	—	—	X	—
0	—	—	—	MINT	A mask of all flags located in Table 01 byte 88h determines the value of MINT. MINT is maskable to 0 if no interrupt is desired by setting Table 01 byte 88h to 0.
72 to 7E	SRAM	R	00	Reserved	—
7F	SRAM	R/W	—	Table select	—
Bit 7	—	—	0	X	—
6	—	—	0	X	—
5	—	—	0	X	—
4	—	—	0	X	—
3	—	—	0	X	—
2	—	—	0	X	—
1	—	—	0	Table select bits	Set bits = 00 to select Table 00, set bits = 01 to select Table 01, set bits = 10 to select Table 02, set bits = 11 to select Table 03.
0	—	—	0		

# Dual Temperature-Controlled Resistors with Three Monitors

0201020

Table 01h

MEMORY LOCATION (hex)	EEPROM/ SRAM	R/W	DEFAULT SETTING (hex)	NAME OF LOCATION	FUNCTION
80	SRAM	R/W		Mode	—
Bit 7	—	—	0	X	—
6	—	—	0	X	—
5	—	—	0	X	—
4	—	—	0	X	—
3	—	—	0	X	—
2	—	—	0	X	—
1	—	—	1	TEN	If TEN = 0, the temperature conversions update and the resistors can be controlled manually. The user sets the resistor in manual mode by writing to addresses 82h and 83h in Table 01 to control resistors 0 and 1, respectively.
0	—	—	1	AEN	AEN = 0 provides manual control of the temperature index.
81	SRAM	R	—	Temp index	This byte is the temperature-calculated index used to select the address of resistor settings in the look-up tables.
82	SRAM	R/W	00	Resistor 0	Resistor 0 position values from 00h to FFh.
83	SRAM	R/W	00	Resistor 1	Resistor 1 position values from 00h to FFh.
84 to 87	SRAM	—	00	Reserved	—
88	EEPROM	R/W		Interrupt enable	This byte configures a maskable interrupt, determining which event asserts a buffer 1 output (MINT set to 1, see register 89h in Table 01). If any combination of temperature, V <sub>CC</sub> , MON1, MON2, or MON3 is desired to generate an interrupt, the corresponding bits are set to 1. If interrupt generation is not desired, set all bits to 0.
Bit 7	—	—	1	TMP	—
6	—	—	1	V <sub>CC</sub>	—
5	—	—	1	MON1	—
4	—	—	1	MON2	—
3	—	—	1	MON3	—
2	—	—	0	X	—
1	—	—	0	X	—
0	—	—	0	X	—
89	EEPROM	R/W		Configuration	—
Bit 7	—	—	0	X	—
6	—	—	0	X	—



# Dual Temperature-Controlled Resistors with Three Monitors

DS1858

**Table 01h (continued)**

MEMORY LOCATION (hex)	EEPROM/ SRAM	R/W	DEFAULT SETTING (hex)	NAME OF LOCATION	FUNCTION
5	—	—	0	ADEN	Controls if the device responds to one or two device addresses (see the <i>Memory Description</i> section and Table 5).
4	—	—	0	ADFIX	Controls the means by which Main and Auxiliary Device addresses are set (see the <i>Memory Description</i> section and Table 5).
3	—	—	0	APEN	Controls auxiliary write protect. See the <i>Memory Description</i> section.
2	—	—	0	MPEN	Controls main write protect. See the <i>Memory Description</i> section.
1	—	—	0	INV1	Configures buffer 1 with $OUT1 = MINT + (INV1 [XOR] IN1)$ .
0	—	—	0	INV2	Configures buffer 2 with $OUT2 = INV2 [XOR] IN2$ .
8A to 8B	EEPROM	—	00	Reserved	
8C	EEPROM	R/W	A2	Device address	Contains Main Device address if the bit ADFIX = 1. If ADFIX = 0, then address A2h is used.
8D to 8F	EEPROM	—	—	Reserved	—

**Table 02h**

MEMORY LOCATION (hex)	EEPROM/ SRAM	R/W	DEFAULT SETTING (hex)	NAME OF LOCATION	FUNCTION
80 to C7	EEPROM	R/W	FF	Resistor 0 Temp LUT	Look-up table for Resistor 0.
F0 to FF	EEPROM	R	FF	Reserved	—

**Table 03h**

MEMORY LOCATION (hex)	EEPROM/ SRAM	R/W	DEFAULT SETTING (hex)	NAME OF LOCATION	FUNCTION
80 to C7	EEPROM	R/W	FF	Resistor 1 Temp LUT	Look-up table for Resistor 1.
F0 to FF	EEPROM	R	FF	Reserved	

# Dual Temperature-Controlled Resistors with Three Monitors

## Temperature Conversion

The direct-to-digital temperature sensor measures temperature through the use of an on-chip temperature measurement technique with an operating range from  $-40^{\circ}\text{C}$  to  $+102^{\circ}\text{C}$ . Temperature conversions are initiated upon power-up, and the most recent conversion is stored in memory locations 60h and 61h of the Main Device, which are updated every  $t_{\text{frame}}$ . Temperature conversions do not occur during an active read or write to memory.

The value of each resistor is determined by the temperature-addressed look-up table. The look-up table assigns a unique value to each resistor for every  $2^{\circ}\text{C}$  increment with a  $1^{\circ}\text{C}$  hysteresis at a temperature transition over the operating temperature range (see Figure 4).

## Power-Up and Low-Voltage Operation

During power-up, the device is inactive until  $V_{\text{CC}}$  exceeds the digital power-on-reset voltage (POD). At this voltage, the digital circuitry, which includes the 2-wire interface, becomes functional. However, EEPROM backed registers/settings cannot be internally read (recalled into shadow SRAM) until  $V_{\text{CC}}$  exceeds the analog power-on-reset voltage (POA) at which time the remainder of the device becomes fully functional. Once  $V_{\text{CC}}$  exceeds POA, the RDYB bit in byte 6Eh of the Main Device memory is timed to go from a 1 to a 0 and indicates when analog to digital conversions begin. If  $V_{\text{CC}}$  ever dips below POA, the RDYB bit will read as a 1 again. Once a device exceeds POA and the EEPROM is recalled, the values remain active (recalled) until  $V_{\text{CC}}$  falls below POD.

For 2-wire device addresses sourced from EEPROM (ADFIX = 1), the device address defaults to A2h until  $V_{\text{CC}}$  exceeds POA and the EEPROM values are recalled. The Auxiliary Device (A0h) is always available within this voltage window (between POD and the EEPROM recall) regardless of the programmed state of ADEN.

Furthermore, as the device powers-up, the  $V_{\text{CCLO}}$  alarm flag (bit 4 of 70h in Main Device) will default to a 1 until the first  $V_{\text{CC}}$  analog-to-digital conversion occurs and sets or clears the flag accordingly.

## 2-Wire Operation

**Clock and Data Transitions:** The SDA pin is normally pulled high with an external resistor or device. Data on the SDA pin may only change during SCL-low time periods. Data changes during SCL-high periods will indicate a start or stop condition depending on the conditions discussed below. See the timing diagrams in Figures 5 and 6 for further details.

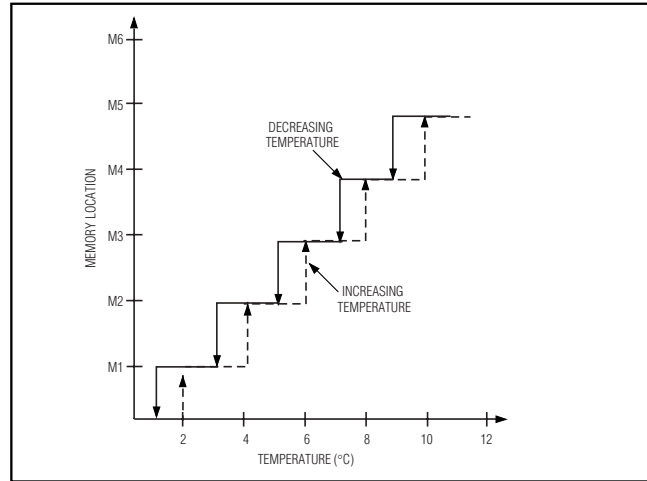

Figure 4. Look-Up Table Hysteresis

**Start Condition:** A high-to-low transition of SDA with SCL high is a start condition, which must precede any other command. See the timing diagrams in Figures 5 and 6 for further details.

**Stop Condition:** A low-to-high transition of SDA with SCL high is a stop condition. After a read or write sequence, the stop command places the DS1858 into a low-power mode. See the timing diagrams in Figures 5 and 6 for further details.

**Acknowledge:** All address and data bytes are transmitted through a serial protocol. The DS1858 pulls the SDA line low during the ninth clock pulse to acknowledge that it has received each word.

**Standby Mode:** The DS1858 features a low-power mode that is automatically enabled after power-on, after a stop command, and after the completion of all internal operations.

**Device Addressing:** The DS1858 must receive an 8-bit device address word following a start condition to enable a specific device for a read or write operation. The address word is clocked into this part's MSB to LSB. The address byte consists of Ah (1010) followed by either A2h or the value in Table 01 8Ch for the Main Device or A0h for the Auxiliary Device then the R/W bit. This byte must match the address programmed into Table 01 8Ch or A0h (for the Auxiliary Device). If a device address match occurs, this part will output a zero for one clock cycle as an acknowledge and the corresponding block of memory is enabled (see the *Memory Organization* section). If the R/W bit is high, a read operation is initiated. If the R/W is low, a write operation is initiated (see the *Memory Organization*

# Dual Temperature-Controlled Resistors with Three Monitors

section). If the address does not match, this part returns to a low-power mode.

## Write Operations

After receiving a matching address byte with the R/W bit set low, provided there is no write protect, the device goes into the write mode of operation (see the *Memory Organization* section). The master must transmit an 8-bit EEPROM memory address to the device to define the address where the data is to be written. After the byte has been received, the DS1858 transmits a zero for one clock cycle to acknowledge the address has been received. The master must then transmit an 8-bit data word to be written into this address. The DS1858 again transmits a zero for one clock cycle to acknowledge the receipt of the data. At this point, the master must terminate the write operation with a stop condition. The DS1858 then enters an internally timed write process  $t_w$  to the EEPROM memory. All inputs are disabled during this byte write cycle.

## Page Write

The DS1858 is capable of an 8-byte page write. A page is any 8-byte block of memory starting with an address evenly divisible by eight and ending with the starting address plus seven. For example, addresses 00h through 07h constitute one page. Other pages would be addresses 08h through 0Fh, 10h through 17h, 18h through 1Fh, etc.

A page write is initiated the same way as a byte write, but the master does not send a STOP condition after the first byte. Instead, after the slave acknowledges the data byte has been received, the master can send up to seven more bytes using the same nine-clock sequence. The master must terminate the write cycle with a STOP condition or the data clocked into the DS1858 will not be latched into permanent memory.

The address counter rolls on a page during a write. The counter does not count through the entire address space as during a read. For example, if the starting address is 06h and 4 bytes are written, the first byte goes into address 06h. The second goes into address 07h. The third goes into address 00h (not 08h). The fourth goes into address 01h. If more than 9 bytes or more are written before a STOP condition is sent, the first bytes sent are overwritten. Only the last 8 bytes of data are written to the page.

**Acknowledge Polling:** Once the internally timed write has started and the DS1858 inputs are disabled, acknowledge polling can be initiated. The process involves transmitting a start condition followed by the device address. The R/W bit signifies the type of operation that is desired. The read or write sequence will only

be allowed to proceed if the internal write cycle has completed and the DS1858 responds with a zero.

## Read Operations

After receiving a matching address byte with the R/W bit set high, the device goes into the read mode of operation. There are three read operations: current address read, random read, and sequential address read.

### Current Address Read

The DS1858 has an internal address register that maintains the address used during the last read or write operation, incremented by one. This data is maintained as long as  $V_{CC}$  is valid. If the most recent address was the last byte in memory, then the register resets to the first address.

Once the device address is clocked in and acknowledged by the DS1858 with the R/W bit set to high, the current address data word is clocked out. The master does not respond with a zero, but does generate a stop condition afterwards.

### Single Read

A random read requires a dummy byte write sequence to load in the data byte address. Once the device and data address bytes are clocked in by the master, and acknowledged by the DS1858, the master must generate another start condition. The master now initiates a current address read by sending the device address with the R/W bit set high. The DS1858 acknowledges the device address and serially clocks out the data byte.

### Sequential Address Read

Sequential reads are initiated by either a current address read or a random address read. After the master receives the first data byte, the master responds with an acknowledge. As long as the DS1858 receives this acknowledge after a byte is read, the master can clock out additional data words from the DS1858. After reaching address FFh, it resets to address 00h.

The sequential read operation is terminated when the master initiates a stop condition. The master does not respond with a zero.

For a more detailed description of 2-wire theory of operation, see the following section.

## 2-Wire Serial Port Operation

The 2-wire serial port interface supports a bidirectional data transmission protocol with device addressing. A device that sends data on the bus is defined as a transmitter, and a device receiving data as a receiver. The device that controls the message is called a master. The devices that are controlled by the master are

# Dual Temperature-Controlled Resistors with Three Monitors

slaves. The bus must be controlled by a master device that generates the serial clock (SCL), controls the bus access, and generates the start and stop conditions. The DS1858 operates as a slave on the 2-wire bus. Connections to the bus are made through the open-drain I/O lines SDA and SCL. The following I/O terminals control the 2-wire serial port: SDA, SCL. Timing diagrams for the 2-wire serial port can be found in Figures 5 and 6. Timing information for the 2-wire serial port is provided in the *AC Electrical Characteristics* table for 2-wire serial communications.

The following bus protocol has been defined:

- Data transfer may be initiated only when the bus is not busy.
- During data transfer, the data line must remain stable whenever the clock line is high. Changes in the data line while the clock line is high will be interpreted as control signals.

Accordingly, the following bus conditions have been defined:

**Bus not busy:** Both data and clock lines remain high.

**Start data transfer:** A change in the state of the data line from high to low while the clock is high defines a start condition.

**Stop data transfer:** A change in the state of the data line from low to high while the clock line is high defines the stop condition.

**Data valid:** The state of the data line represents valid data when, after a start condition, the data line is stable for the duration of the high period of the clock signal. The data on the line can be changed during the low period of the clock signal. There is one clock pulse per bit of data. Figures 5 and 6 detail how data transfer is accomplished on the 2-wire bus. Depending upon the state of the R/W bit, two types of data transfer are possible.

Each data transfer is initiated with a start condition and terminated with a stop condition. The number of data bytes transferred between start and stop conditions is not limited and is determined by the master device. The information is transferred byte-wise and each receiver acknowledges with a ninth bit.

Within the bus specifications a regular mode (100kHz clock rate) and a fast mode (400kHz clock rate) are defined. The DS1858 works in both modes.

**Acknowledge:** Each receiving device, when addressed, is obliged to generate an acknowledge after the byte has been received. The master device must generate an extra clock pulse, which is associated with this acknowledge bit.

A device that acknowledges must pull down the SDA line during the acknowledge clock pulse in such a way that the SDA line is a stable low during the high period of the acknowledge-related clock pulse. Setup and hold times must be taken into account. A master must signal an end of data to the slave by not generating an acknowledge bit on the last byte that has been clocked out of the slave. In this case, the slave must leave the data line high to enable the master to generate the stop condition.

- 1) Data transfer from a master transmitter to a slave receiver. The first byte transmitted by the master is the command/control byte. Next follows a number of data bytes. The slave returns an acknowledge bit after each received byte.
- 2) Data transfer from a slave transmitter to a master receiver. The master transmits the first byte (the command/control byte) to the slave. The slave then returns an acknowledge bit. Next follows a number of data bytes transmitted by the slave to the master. The master returns an acknowledge bit after all received bytes other than the last byte. At the end of the last received byte, a not acknowledge can be returned.

The master device generates all serial clock pulses and the start and stop conditions. A transfer is ended with a stop condition or with a repeated start condition. Since a repeated start condition is also the beginning of the next serial transfer, the bus will not be released.

The DS1858 can operate in the following three modes:

- 1) **Slave Receiver Mode:** Serial data and clock are received through SDA and SCL, respectively. After each byte is received, an acknowledge bit is transmitted. Start and stop conditions are recognized as the beginning and end of a serial transfer. Address recognition is performed by hardware after the slave (device) address and direction bit have been received.
- 2) **Slave Transmitter Mode:** The first byte is received and handled as in the slave receiver mode. However, in this mode the direction bit indicates that the transfer direction is reversed. Serial data is transmitted on SDA by the DS1858, while the serial clock is input on SCL. Start and stop conditions are recognized as the beginning and end of a serial transfer.
- 3) **Slave Address:** Command/control byte is the first byte received following the start condition from the master device. The command/control byte consists of 4-bit control code. They are used by the master device to select which of eight possible

# Dual Temperature-Controlled Resistors with Three Monitors

devices on the bus is to be accessed. When reading or writing the DS1858, the device-select bits must match one of two valid device addresses, 00h or the address registered in Table 01 location 8Ch. The last bit of the command/control byte (R/W) defines the operation to be performed. When set to a '1' a read operation is selected, and when set to a '0' a write operation is selected. The slave address can be set by the EEPROM.

Following the start condition, the DS1858 monitors the SDA bus checking the device type identifier being transmitted. Upon receiving the 1010 control code, the appropriate device address bits, and the read/write bit, the slave device outputs an acknowledge signal on the SDA line.

## Chip Topology

TRANSISTOR COUNT: 44149

SUBSTRATE CONNECTED TO GROUND

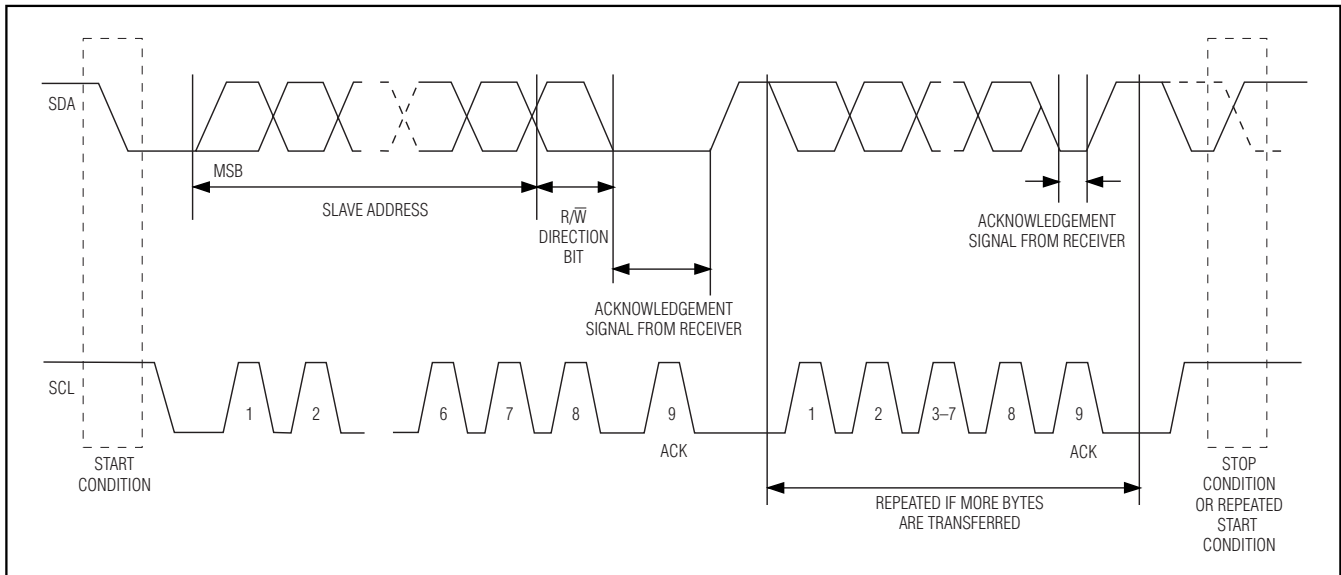

Figure 5. 2-Wire Data Transfer Protocol

# Dual Temperature-Controlled Resistors with Three Monitors

DS1020

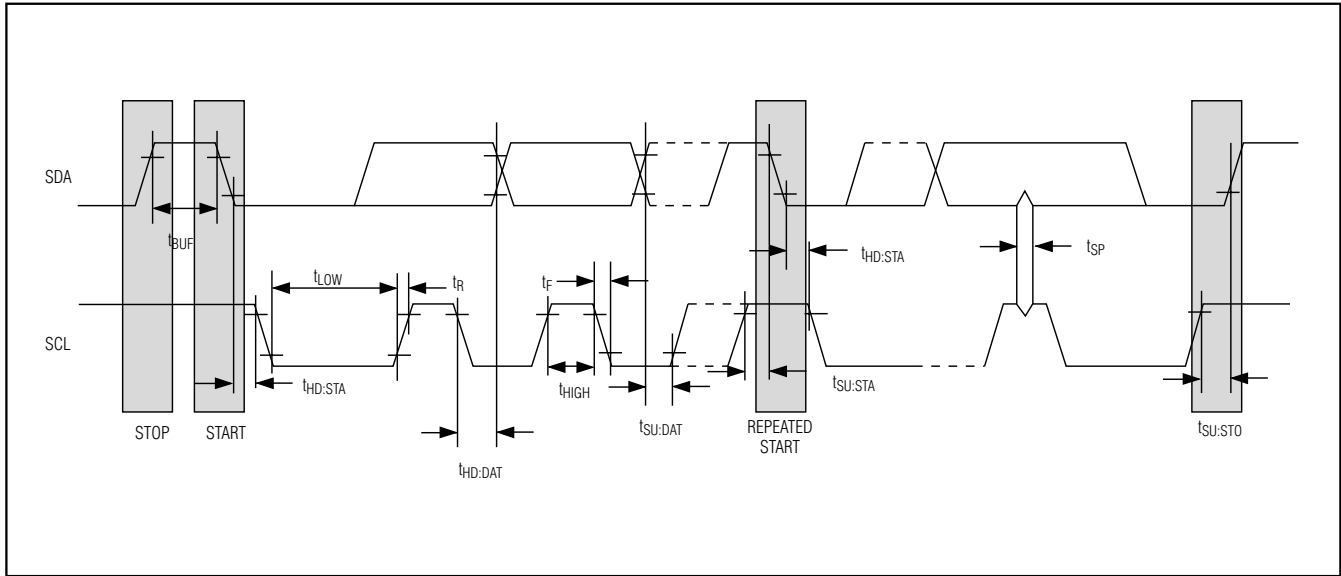

Figure 6. 2-Wire AC Characteristics

Maxim cannot assume responsibility for use of any circuitry other than circuitry entirely embodied in a Maxim product. No circuit patent licenses are implied. Maxim reserves the right to change the circuitry and specifications without notice at any time.

Maxim Integrated Products, 120 San Gabriel Drive, Sunnyvale, CA 94086 408-737-7600 \_\_\_\_\_ 22