

General Description

The QPL9095 is a high-linearity, ultra-low noise gain block amplifier with a bypass mode functionality integrated in the product. At 900MHz, the amplifier typically provides 22 dB gain, +33 dBm OIP3, and 0.6 dB noise figure while drawing 50 mA current from a +4.2 V supply.

The QPL9095 is internally matched using a high performance E-PHEMT process and only requires four external components for operation from a single positive supply: an external RF choke and blocking/bypass capacitors. This low noise amplifier contains an internal active bias to maintain high performance over temperature.

The QPL9095 is optimized for the 500MHz–1000MHz frequency band and is targeted for wireless infrastructure. The QPL9095 is packaged in a 2 x 2 mm DFN.



8 Pin 2X2 mm DFN Package

Product Features

- 500MHz – 1000MHz Operational bandwidth
- LNA with integrated bypass mode
- Ability to turn LNA and bypass mode OFF
- Ultra low noise, 0.6 dB at 900MHz
- 22 dB Gain at 900MHz
- +33 dBm Output IP3 in LNA Mode
- +35 dBm Output IP3 in Bypass Mode
- Internally matched
- Positive supply only, +3.3 to +5 V
- 2x2 mm 8-pin DFN plastic package

Functional Block Diagram



Top View

Applications

- Base-station Receivers
- Repeaters / DAS
- Tower Mounted Amplifiers
- Mobile Infrastructure
- General Purpose Wireless
- TDD or FDD systems

Ordering Information

Part No.	Description
QPL9095SR	100 pcs on 7" reel
QPL9095TR7	2500 pcs on 7" reel
QPL9095EV01	Evaluation Board

Absolute Maximum Ratings

Parameter	Rating
Storage Temperature	-65 to 150°C
Supply Voltage (V _{DD})	+7 V
RF Input Power, CW, 50Ω, T=25°C	+30 dBm

Operation of this device outside the parameter ranges given above may cause permanent damage.

Recommended Operating Conditions

Parameter	Min	Typ	Max	Units
Supply Voltage (V _{DD})	3.0	4.2	5.25	V
T _{CASE}	-40		+105	°C
T _j at T _{CASE} = 125°C			+142	°C

Electrical specifications are measured at specified test conditions. Specifications are not guaranteed over all recommended operating conditions.

Electrical Specifications

Test conditions unless otherwise noted: V_{DD} = +4.2 V, Temp.=+25°C.

Parameter	Conditions	Min	Typ	Max	Units
Operational Frequency Range		500		1000	MHz
Test Frequency			900		MHz
Gain	LNA ON, Bypass OFF	20.5	22	23.5	dB
Input Return Loss	LNA ON, Bypass OFF		8.5		dB
Output Return Loss	LNA ON, Bypass OFF		11		dB
Noise Figure ⁽²⁾	LNA ON, Bypass OFF		0.6	0.9	dB
Output P1dB ⁽¹⁾	LNA ON, Bypass OFF	+18.5	+20		dBm
Output IP3	LNA ON, Bypass OFF, P _{out} =+2 dBm/tone, Δf=1 MHz	+30	+33		dBm
Insertion Loss	LNA OFF, Bypass ON		1.2	2.5	dB
Return Loss	LNA OFF, Bypass ON		12		dB
Isolation ⁽¹⁾	LNA OFF, Bypass OFF	15	18		dB
Output IP3	LNA OFF, Bypass ON Pin=+2 dBm/tone, Δf=1 MHz	+30	+35		dBm
Control Voltage, V ₁ , V ₂	V _{IH}	1.17		V _{DD}	V
	V _{IL}	0		0.63	V
Current, I _D	Bypass OFF	40	53	75	mA
	Bypass ON		5		mA
Switching Speed	LNA-Bypass (50% V _{ctrl} to 10% RF)		40		ns
	Bypass-LNA(50% V _{ctrl} to 90% RF)		185		ns
	LNA-OFF(50% V _{ctrl} to 10% RF)		40		ns
	OFF-LNA(50% V _{ctrl} to 90% RF)		65		ns
Thermal Resistance, θ _{jc}	Channel to case		44		°C/W

1. Minimum specification listed is guaranteed by design. Not tested in production.
2. Input trace loss de-embedded from Noise Figure data.

Control Truth Table

V _{BYP}	V _{SD}	State
0	0	LNA ON, Bypass OFF
0	1	LNA OFF, Bypass OFF
1	x	LNA OFF, Bypass ON

Performance Plots

Test conditions unless otherwise noted: $V_{DD} = +4.2\text{ V}$, Temp. = $+25\text{ }^\circ\text{C}$

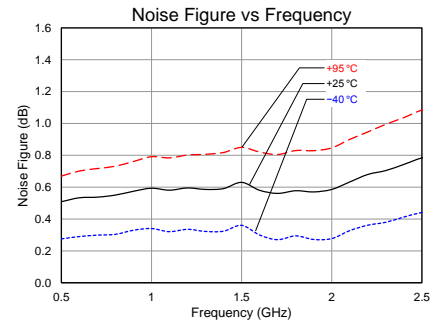
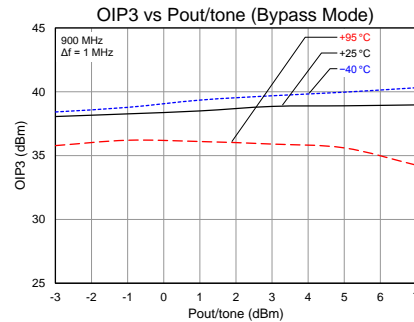
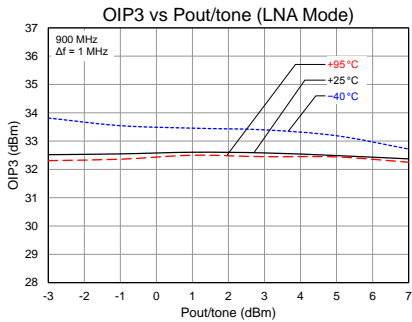
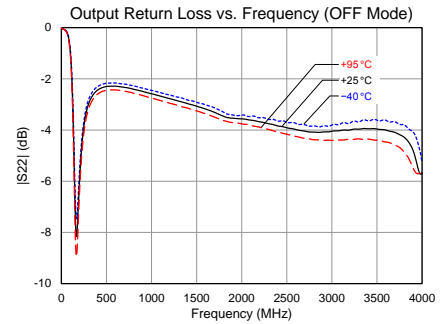
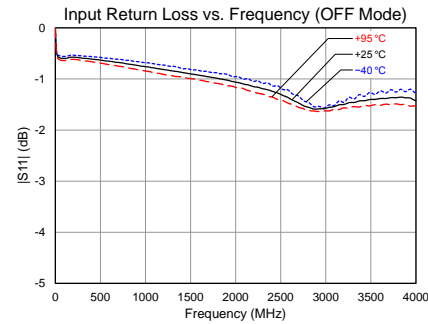
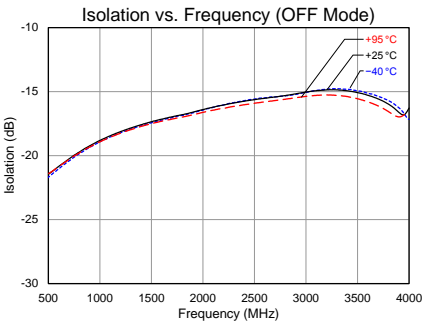
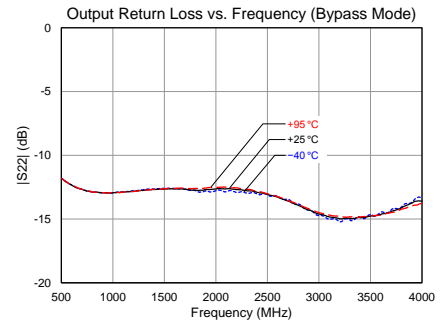
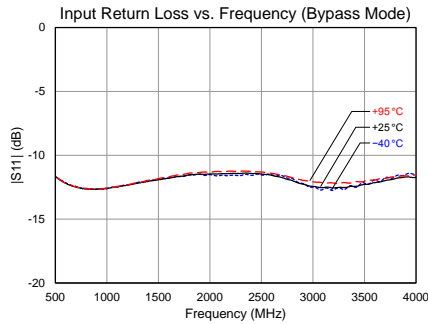
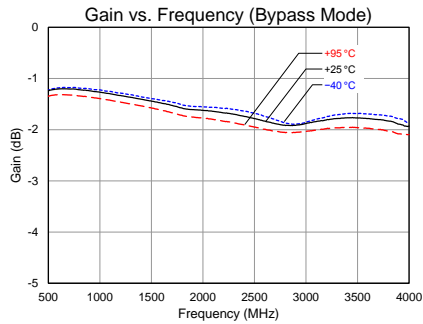
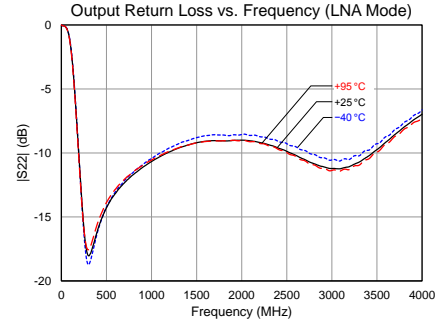
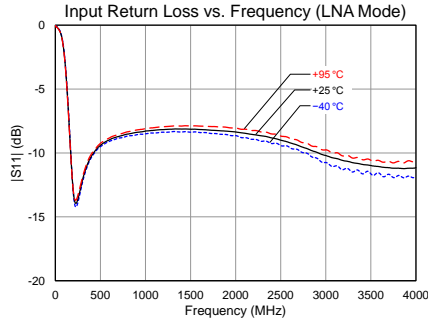
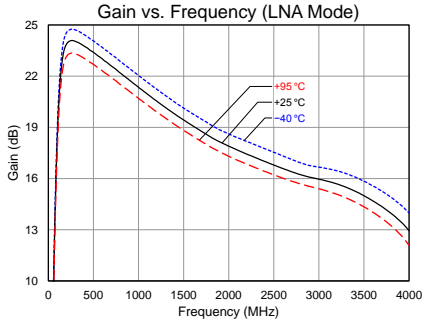

QPL9095 Improved Return Loss Tune

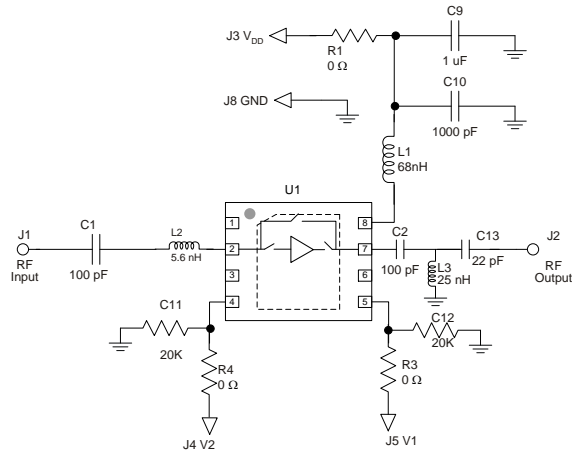
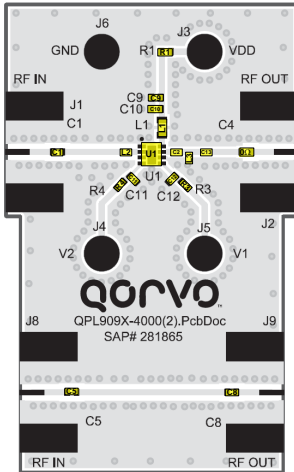

Performance Plots

Test conditions unless otherwise noted: $V_{DD} = +4.2\text{ V}$, $\text{Temp.} = +25\text{ }^\circ\text{C}$

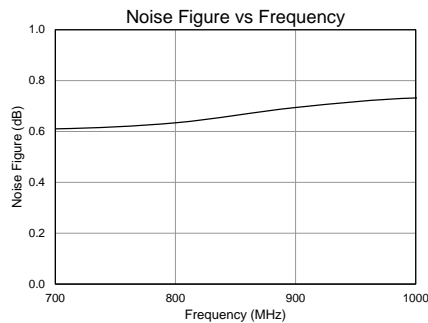
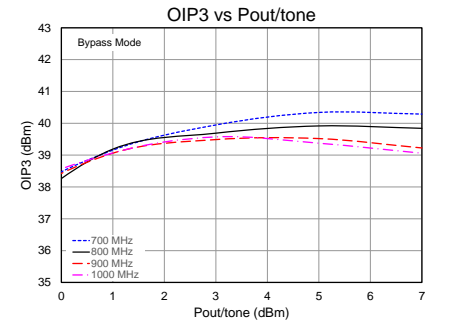
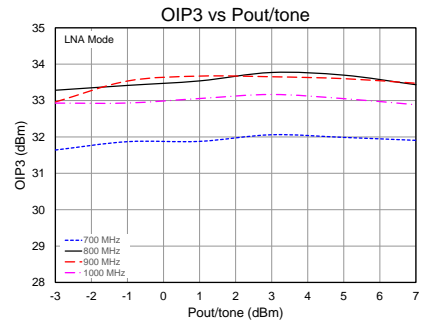
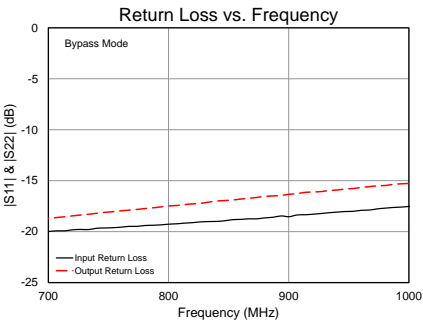
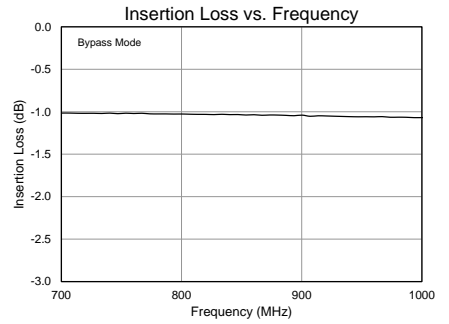
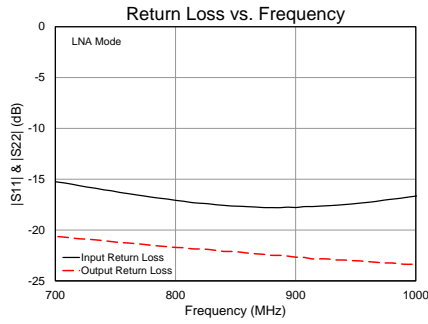
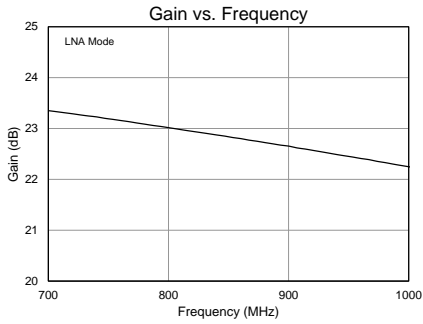

Pin Configuration and Description

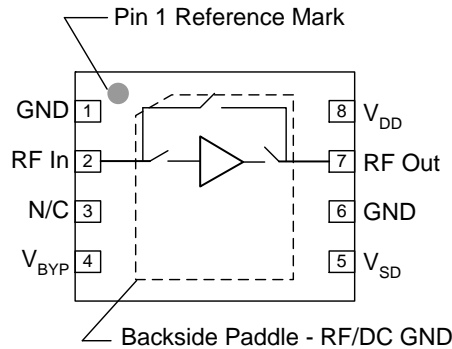

Pin No.	Label	Description
1, 6	GND	RF/DC Ground pin.
2	RFin	RF input pin. DC block required.
3	N/C	No internal connection. Provide grounded PCB land pads for mounting integrity.
4	V _{BYP}	Control pin for bypass mode. The LNA is automatically turned off when the bypass mode is activated. Refer to truth table on pg 2.
5	V _{SD}	Control pin to disable the LNA. Refer to truth table on pg. 2.
7	RFout	RF output pin. DC block required.
8	V _{DD}	Supply voltage pin. External choke and bypass capacitors needed.
Backside Paddle	RF/DC GND	RF/DC Ground. Follow recommended via pattern and ensure good solder attach for best thermal and electrical performance.

Evaluation Board PCB Information

Qorvo PCB 281865 Material and Stack-up

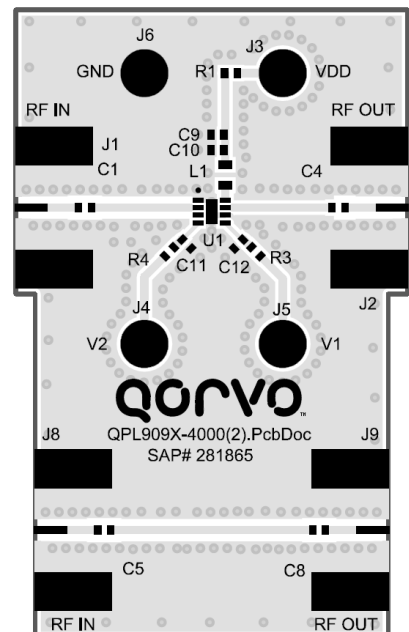
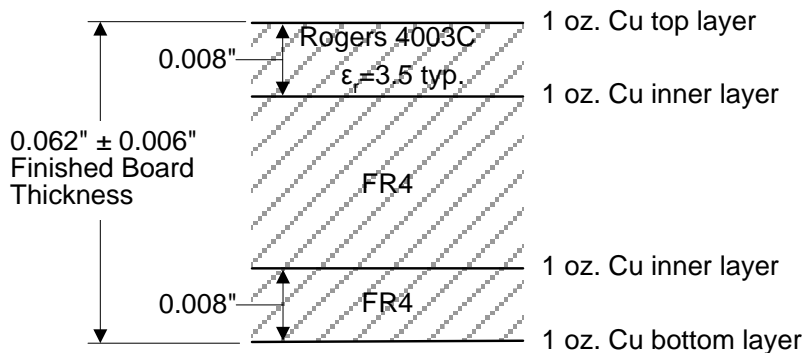

Mechanical Information

Package Marking and Dimensions

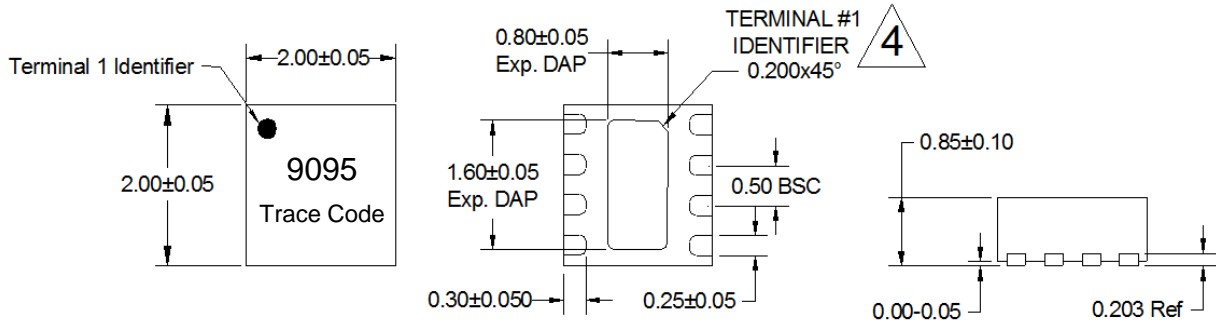

Notes:

1. All dimensions are in millimeters. Angles are in degrees.
2. Except where noted, this part outline conforms to JEDEC standard MO-220, Issue E (Variation VGGC) for thermally enhanced plastic very thin fine pitch quad flat no lead package (QFN).
3. Dimension and tolerance formats conform to ASME Y14.4M-1994.
4. The terminal #1 identifier and terminal numbering conform to JESD 95-1 SPP-012.

PCB Mounting Pattern

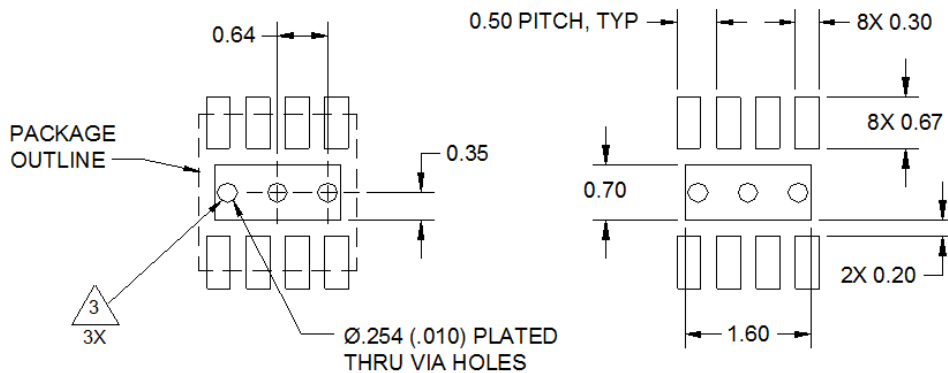

Notes:

1. All dimensions are in millimeters. Angles are in degrees.
2. Use 1 oz. copper minimum for top and bottom layer metal.
3. Vias are required under the backside paddle of this device for proper RF/DC grounding and thermal dissipation. We recommend a 0.35 mm ($\#80/.0135$ ") diameter bit for drilling via holes and a final plated thru diameter of 0.25 mm (0.10 ").
4. Ensure good package backside paddle solder attach for reliable operation and best electrical performance.

Handling Precautions

Parameter	Rating	Standard
ESD – Human Body Model (HBM)	Class 1B	ESDA / JEDEC JS-001-2014
ESD – Charged Device Model (CDM)	Class C3	ESDA / JEDEC JS-002-2014
MSL – Moisture Sensitivity Level	1	IPC/JEDEC J-STD-020



Caution!
ESD-Sensitive Device

Solderability

Compatible with lead-free (260°C max. reflow temp.) soldering process.
Solder profiles available upon request.

Contact plating: NiPdAu

RoHS Compliance

This part is compliant with 2011/65/EU RoHS directive (Restrictions on the Use of Certain Hazardous Substances in Electrical and Electronic Equipment) as amended by Directive 2015/863/EU.

This product also has the following attributes:

- Lead Free
- Halogen Free (Chlorine, Bromine)
- Antimony Free
- TBBP-A (C₁₅H₁₂Br₄O₂) Free
- PFOS Free
- SVHC Free



Contact Information

For the latest specifications, additional product information, worldwide sales and distribution locations:

Web: www.qorvo.com

Tel: 1-844-890-8163

Email: customer.support@qorvo.com

For technical questions and application information: **Email:** appsupport@qorvo.com

Important Notice

The information contained herein is believed to be reliable; however, Qorvo makes no warranties regarding the information contained herein and assumes no responsibility or liability whatsoever for the use of the information contained herein. All information contained herein is subject to change without notice. Customers should obtain and verify the latest relevant information before placing orders for Qorvo products. The information contained herein or any use of such information does not grant, explicitly or implicitly, to any party any patent rights, licenses, or any other intellectual property rights, whether with regard to such information itself or anything described by such information. **THIS INFORMATION DOES NOT CONSTITUTE A WARRANTY WITH RESPECT TO THE PRODUCTS DESCRIBED HEREIN, AND QORVO HEREBY DISCLAIMS ANY AND ALL WARRANTIES WITH RESPECT TO SUCH PRODUCTS WHETHER EXPRESS OR IMPLIED BY LAW, COURSE OF DEALING, COURSE OF PERFORMANCE, USAGE OF TRADE OR OTHERWISE, INCLUDING THE IMPLIED WARRANTIES OF MERCHANTABILITY AND FITNESS FOR A PARTICULAR PURPOSE.**

Without limiting the generality of the foregoing, Qorvo products are not warranted or authorized for use as critical components in medical, life-saving, or life-sustaining applications, or other applications where a failure would reasonably be expected to cause severe personal injury or death.

Copyright 2016 © Qorvo, Inc. | Qorvo is a registered trademark of Qorvo, Inc.