

DE10-Pro

for Intel® FPGA University Program
USER MANUAL

FPGA

Contents

Chapter 1	Overview	6
1.1	General Description	6
1.2	Key Features.....	7
1.3.	Block Diagram.....	8
1.4.	Board Power On.....	11
Chapter 2	Board Component	12
2.1	Board Overview.....	12
2.2	Configuration, Status and Setup	13
2.3	General User Input/Output	17
2.4	Temperature Sensor and Fan Control	19
2.5	Power Monitor	21
2.6	Clock Circuit	22
2.7	FLASH Memory.....	25
2.8	DDR4 SO-DIMM	27
2.9	QSPF28 Ports.....	52
2.10	PCI Express	60



Chapter 3	<i>System Builder</i>	68
3.1	Introduction	68
3.2	General Design Flow.....	69
3.3	Using System Builder.....	70
Chapter 4	<i>CFI-Flash Programming</i>	79
4.1	FPGA Configure Operation	79
4.2	CFI Flash Memory Map.....	80
4.3	Flash Example Designs	82
4.4	Flash_Programming Example.....	83
4.5	Flash_Factory Example	84
4.6	Flash_User Example.....	85
4.7	Flash_Tool Example.....	86
4.8	Programming Batch File.....	86
4.9	Restore Factory Settings.....	87
Chapter 5	<i>Peripheral Reference Design</i>	89
5.1	Configure Si5340A in RTL.....	89
5.2	Nios II control for SI5340/ Temperature/ Power/Fan	96
5.3	Fan Speed Control	104

Chapter 6	<i>Memory Reference Design</i>	108
6.1	DDR4 SDRAM Test.....	108
6.2	DDR4 SDRAM Test by Nios II.....	110
6.3	QDRII+ SRAM Test.....	116
Chapter 7	<i>PCI Express Reference Design for Windows</i>	120
7.1	PCI Express System Infrastructure.....	120
7.2	PC PCI Express Software SDK.....	121
7.3	PCI Express Software Stack.....	122
7.4	PCI Express Library API.....	127
7.5	PCIe Reference Design -Fundamental.....	133
7.6	PCIe Reference Design - DDR4.....	141
Chapter 8	<i>PCI Express Reference Design for Linux</i>	150
8.1	PCI Express System Infrastructure.....	150
8.2	PC PCI Express Software SDK.....	151
8.3	PCI Express Software Stack.....	152
8.4	PCI Express Library API.....	154
8.5	PCIe Reference Design -Fundamental.....	155
8.6	PCIe Reference Design - DDR4.....	161

Chapter 9	<i>Transceiver Verification</i>	169
9.1	Transceiver Test Code	169
9.2	Loopback Fixture.....	169
9.3	Testing by Transceiver Test Code	170
9.4	100G Ethernet Example (H-Tile FPGA)	173
9.5	40G Ethernet Example (L-Tile FPGA)	177
Chapter 10	<i>Additional Information</i>	182
10.1	Getting Help	182

Chapter 1

Overview

This chapter provides an overview of the DE10-Pro Development Board and installation guide.

1.1 General Description

The Terasic DE10-Pro Stratix® 10 GX/SX FPGA Development Kit provides the ideal hardware solution for designs that demand high capacity and bandwidth memory interfacing, ultra-low latency communication, and power efficiency. With a full-height, 3/4-length form-factor package, the DE10-Pro is designed for the most demanding high-end applications, empowered with the top-of-the-line Intel Stratix® 10 GX/SX, delivering the best system-level integration and flexibility in the industry.

The Stratix® 10 GX/SX FPGA features integrated transceivers that transfer at a maximum of 28.3 Gbps, allowing the DE10-Pro to be fully compliant with version 3.0 of the PCI Express standard, as well as allowing an ultra low-latency, straight connections to four external 100G QSFP28 modules. Not relying on an external PHY will accelerate mainstream development of network applications enabling customers to deploy designs for a broad range of high-speed connectivity applications. For designs that demand high capacity and high speed for memory and storage, the DE10-Pro delivers with high-speed parallel flash memory and four SO-DIMM sockets that support DDR4 SDRAM, QDR-IV and QDRII+ options to provide flexible memory configuration. The feature-set of the DE10-Pro fully supports all high-intensity applications such as low-latency trading, cloud computing, high-performance computing, data acquisition, network processing, and signal processing.

1.2 Key Features

The following hardware is implemented on the DE10-Pro board:

■ FPGA

- Intel Stratix ® 10 FPGA
 - DE10-Pro-GH2E2-280: 1SG280HU2F50E2VG
 - DE10-Pro-GH2E2-165: 1SG165HU2F50E2VG

■ FPGA Configuration

- On-Board USB Blaster II or JTAG header for FPGA programming
- Avalon-ST x8 configuration via MAX V CPLD and flash memory
- AS x4 configuration via EPCQ-L configuration device (DNI)

■ General user input/output

- 4 LEDs
- 2 push-buttons
- 2 dip switches

■ Clock System

- 50MHz and 100MHz Oscillators
- Programmable clock generators Si5340A
- Two UFL connectors for external clock inputs
- One 2x5 GPIO timing expansion header

■ Memory

- Four SO-DIMM Sockets, support DDR4 SDRAM, QDR-IV and QDRII+ memory modules
- 128M Parallel FLASH

■ Communication Ports

- Four QSFP28 connectors
- PCI Express (PCIe) x16 edge connector

■ System Monitor and Control

- Temperature sensor
- Fan control
- Power monitor

■ Power

- One PCI Express 8-pin power connector, 12V DC Input
- PCI Express edge connector power

■ Mechanical Specification

- PCI Express full-height and 3/4-length

1.3. Block Diagram

Figure 1-1 shows the block diagram of the DE10-Pro board. To provide maximum flexibility for the users, all key components are connected to the Stratix®10 GX/SX FPGA device. Thus, users can configure the FPGA to implement any system design.

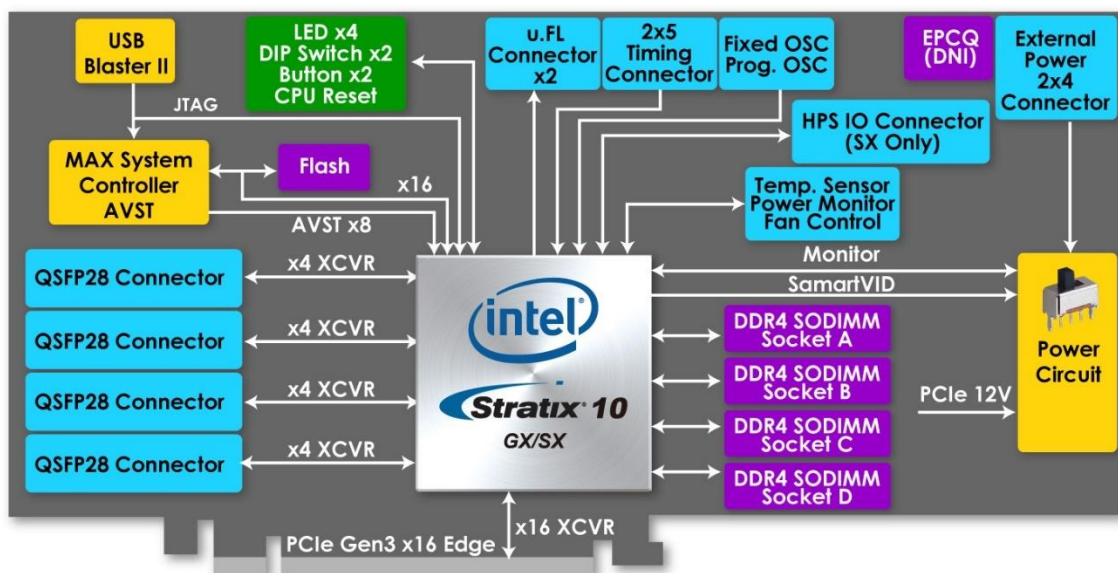

Figure 1-1 Block diagram of the DE10-Pro board

Below is more detailed information regarding the blocks in Figure 1-1.

■ Stratix 10 GX/SX FPGA

- GX/SX 2800
 - 2,800K logic elements (LEs)
 - 229 Mbits embedded memory(M20K)
 - 96 transceivers (up to 28.3Gbps)
 - 11,520 18-bit x 19-bit multipliers
 - 5,760 Variable-precision DSP blocks
 - 4 PCI Express hard IP blocks
 - 704 user I/Os
 - 576 LVDS channels
 - 56 phase locked loops (PLLs)

- GX 1650
 - 1,650K logic elements (LEs)
 - 114 Mbits embedded memory(M20K)
 - 96 transceivers (up to 28.3Gbps)
 - 6,290 18-bit x 19-bit multipliers
 - 3,145 Variable-precision DSP blocks
 - 4 PCI Express hard IP blocks
 - 704 user I/Os
 - 336 LVDS channels
 - 46 phase locked loops (PLLs)

■ JTAG Header and FPGA Configuration

- On-board USB Blaster II or JTAG header for use with the Quartus Prime Programmer
- MAX V CPLD 5M2210 System Controller and Avalon-ST x8 configuration
- AS x4 configuration via EPCQ-L configuration device (DNI)

■ Memory devices

- 4 SO-DIMM sockets, each supports up to 8GB ECC DDR4 SDRAM or 16MB QDR-IV SRAM or 16MB QDRII+ SRAM
- 128MB FLASH

■ General user I/O

- 4 user controllable LEDs
- 2 user push buttons
- 2 user dip switches
- One 2x5 GPIO timing expansion header

■ On-Board Clock

- 50MHz and 100MHz Oscillators
- Programming PLL providing clock for 40G/100G QSFP28 transceiver
- Programming PLL providing clocks for DDR4 SDRAM, QDR-IV SRAM and QDRII+ SRAM

■ Four QSFP28 ports

- Four QSFP28 connector (40/100 Gbps+)

■ PCI Express x16 edge connector

- Support for PCIe x16 Gen1/2/3
- Edge connector for PC motherboard with x16 PCI Express slot

■ Power Source

- PCI Express 8-pin DC 12V power
- PCI Express edge connector power

1.4. Board Power On

There are two switches SW1 and SW2 on the board which can control the board power supply status, as shown in **Figure 1-2**.

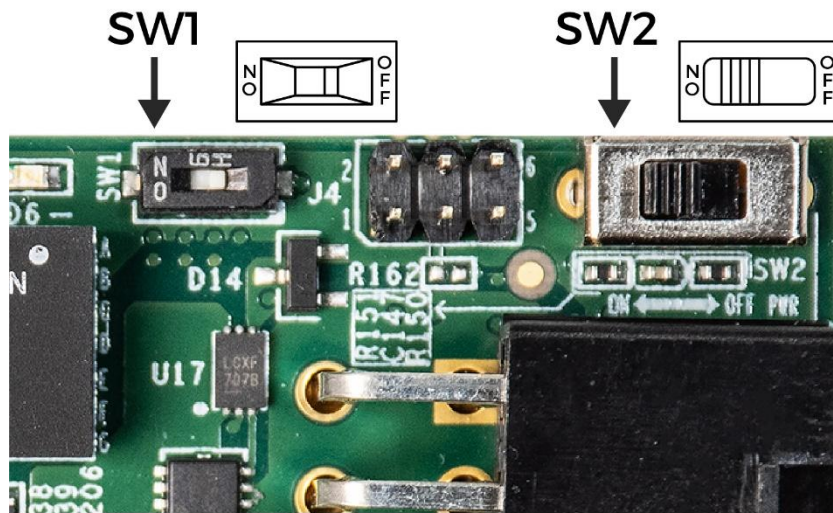

Figure 1-2 Board Power Control Switches

The SW1 is default set as ON. When install the board on the PC, users must connect the 2x4 pin 12V DC external power connector to the board, otherwise the board will not be power on. This restriction is designed to avoid FPGA damage due to insufficient power. Users can set it as OFF if the FPGA utilization rate is low and PCIe edge power source is sufficient.

The SW2 is the external power ON/OFF switch for the board, it is available for Standalone mode and will be noneffective when the PCIe external power is connected.

Chapter 2

Board Component

This chapter introduces all the important components on the DE10-Pro.

2.1 Board Overview

Figure 2-1 and Figure 2-2 is the top and bottom view of the DE10-Pro development board. It depicts the layout of the board and indicates the location of the connectors and key components. Users can refer to this figure for relative location of the connectors and key components.

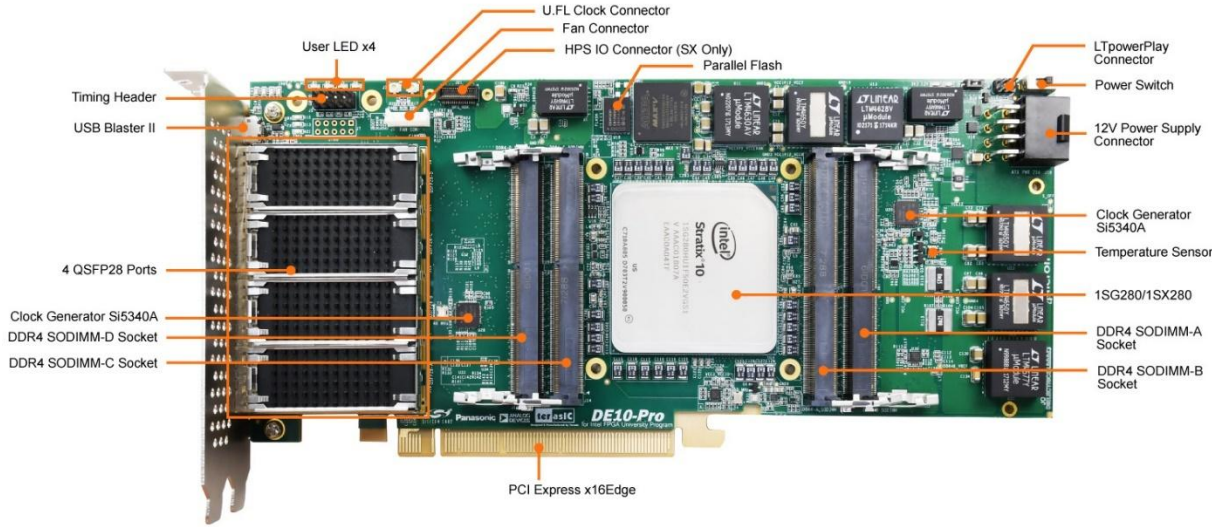

Figure 2-1 FPGA Board (Top)

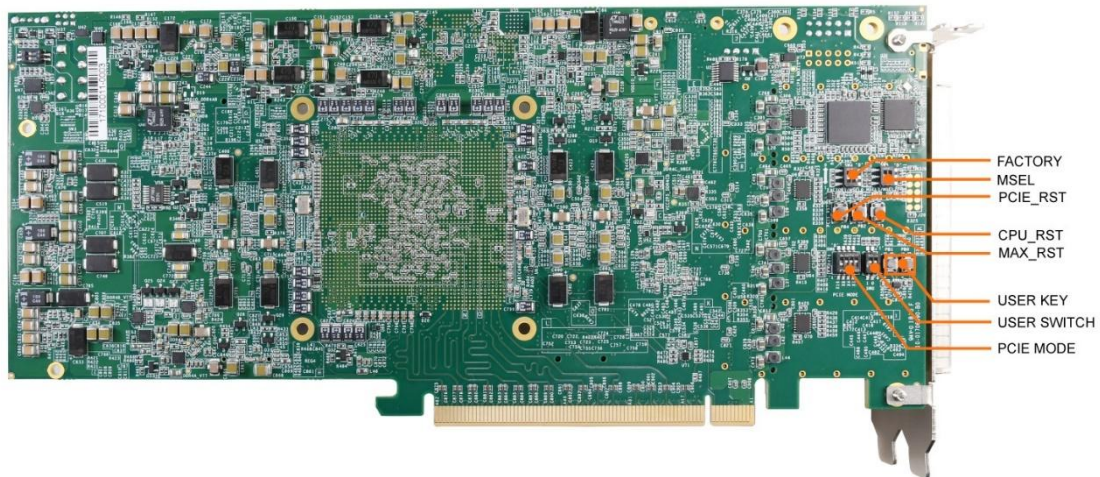

Figure 2-2 FPGA Board (Bottom)

2.2 Configuration, Status and Setup

■ Configure

The FPGA board supports two configuration methods for the Stratix 10 GX/SX FPGA:

- Configure the FPGA using the on-board USB-Blaster II.
- Flash memory configuration of the FPGA using stored images from the flash memory on power-up.

For programming by on-board USB-Blaster II, the following procedures show how to download a configuration bit stream into the Stratix 10 GX/SX FPGA:

- Make sure that power is provided to the FPGA board
- Connect your PC to the FPGA board using a micro-USB cable and make sure the USB-Blaster II driver is installed on PC.
- Launch Quartus Prime programmer and make sure the USB-Blaster II is detected.
- In Quartus Prime Programmer, add the configuration bit stream file (.sof), check the associated “Program/Configure” item, and click “Start” to start FPGA programming.

■ Status LED

The FPGA Board development board includes board-specific status LEDs to indicate board status. Please refer to **Table 2-1** for the description of the LED indicator.

Table 2-1 Status LED

Board Reference	LED Name	Description
D6	12-V Power	Illuminates when 12-V power is active.
D5	3.3-V Power	Illuminates when 3.3-V power is active.
D4	CONF DONE	Illuminates when the FPGA is successfully configured. Driven by the MAX V CPLD 5M2210 System Controller.
D3	Loading	Illuminates when the MAX V CPLD 5M2210 System Controller is actively configuring the FPGA. Driven by the MAX 10 CPLD 10M04SCU169 System Controller with the Embedded Blaster CPLD.
D2	Error	Illuminates when the MAX 10 CPLD 10M04SCU169 System Controller fails to configure the FPGA. Driven by the MAX 10 CPLD 10M04SCU169 System Controller.
D1	PAGE	Illuminates when FPGA is configured by the factory configuration bit stream.

■ Setup PCI Express Control DIP switch

The PCI Express Control DIP switch (SW6) is provided to enable or disable different configurations of the PCIe Connector. **Table 2-2** lists the switch controls and description.

Table 2-2 SW6 PCIe Control DIP Switch

Board Reference	Signal Name	Description	Default
SW6.1	PCIE_PRSENT2n_x1	On : Enable x1 presence detect Off: Disable x1 presence detect	Off

SW6.2	PCIE_PRSENT2n_x4	On : Enable x4 presence detect Off: Disable x4 presence detect	Off
SW6.3	PCIE_PRSENT2n_x8	On : Enable x8 presence detect Off: Disable x8 presence detect	Off
SW6.4	PCIE_PRSENT2n_x16	On : Enable x16 presence detect Off: Disable x16 presence detect	On

■ Setup Configure Mode

The SW4 and SW5 slide switches are used to specify the configuration mode of the FPGA. As currently only Avalon-ST x8 mode is supported, please set MSEL[2:0] to 110 positions as shown in **Figure 2-3**.

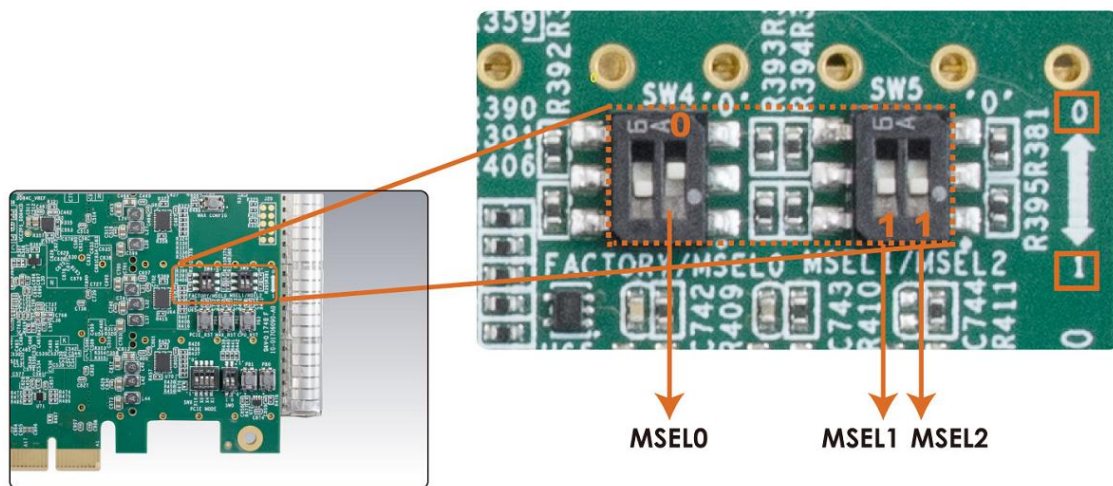
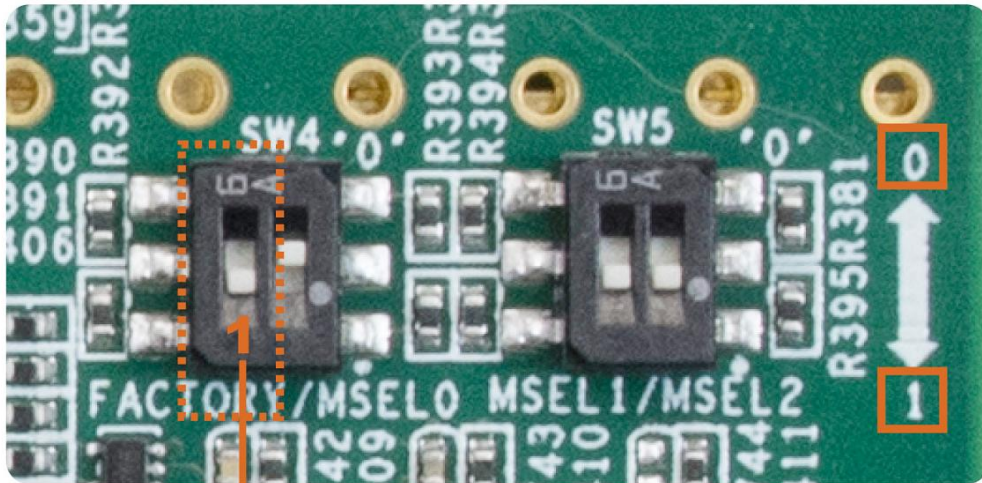

Figure 2-3 Position of slide switches SW4 and SW5 for Configuration Mode

■ Select Flash Image for Configuration

The one position of slide switch SW4 is used to specify the image for configuration of the FPGA. Setting Position FACTORY of SW4 to “1” (down position) specifies the default factory image to be loaded, as shown in **Figure 2-4**. Setting Position FACTORY of SW4 to “0” (up position) specifies the DE10-Pro to load a user-defined image, as shown in **Figure 2-5**.



FACTORY

Figure 2-4 FACTORY position of slide switch SW4 for Image Select – Factory Image Load

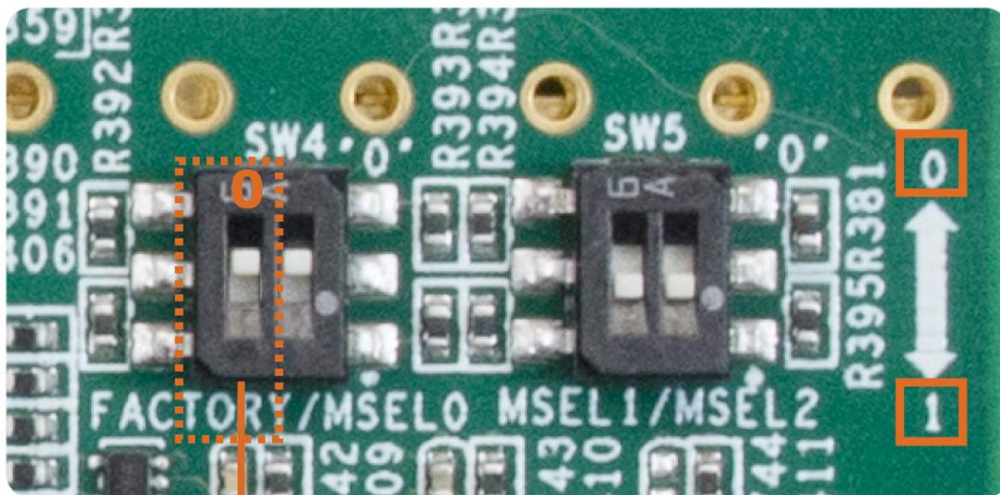

FACTORY

Figure 2-5 FACTORY position of slide switch SW4 for Image Select – User Image Load

2.3 General User Input/Output

This section describes the user I/O interface of the FPGA.

■ User Defined Push-buttons

The FPGA board includes two user defined push-buttons that allow users to interact with the Stratix 10 GX/SX device. Each push-button provides a high logic level or a low logic level when it is not pressed or pressed, respectively. **Table 2-3** lists the board references, signal names and their corresponding Stratix 10 GX/SX device pin numbers.

Table 2-3 Push-button Pin Assignments, Schematic Signal Names, and Functions

Board Reference	Schematic Signal Name	Description	I/O Standard	Stratix 10 GX/SX Pin Number
PB0	BUTTON0	High Logic Level when the button is not pressed	1.8-V	PIN_D24
PB1	BUTTON1		1.8-V	PIN_D23

■ User-Defined Dip Switch

There are two positions dip switch (SW0) on the FPGA board to provide additional FPGA input control. When a position of dip switch is in the DOWN position or the UPPER position, it provides a low logic level or a high logic level to the Stratix 10 GX/SX FPGA, respectively, as shown in **Figure 2-6**.

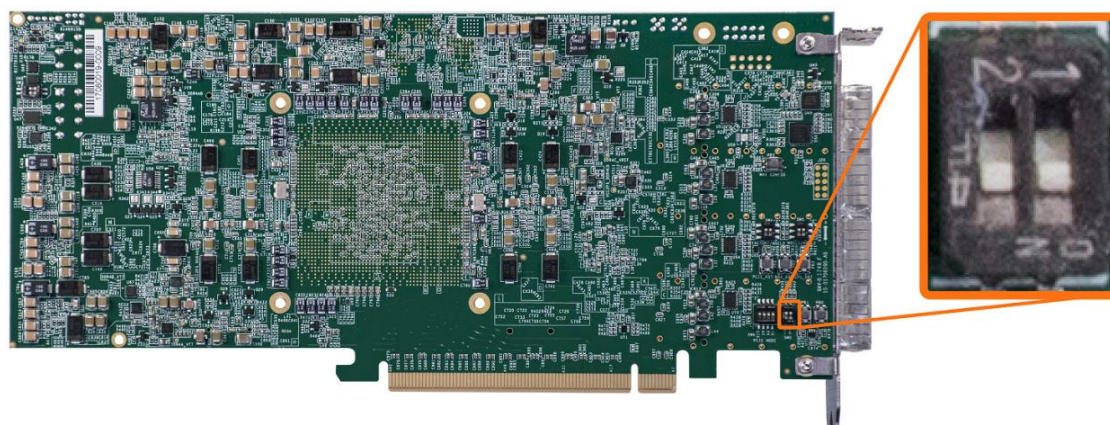

Figure 2-6 One Dip switch

Table 2-4 lists the signal names and their corresponding Stratix 10 GX/SX device pin numbers.

Table 2-4 Dip Switch Pin Assignments, Schematic Signal Names, and Functions

Board Reference	Schematic Signal Name	Description	I/O Standard	Stratix 10 GX/SX Pin Number
SW0	SW0	High logic level when SW in the UPPER position.	1.8-V	PIN_C23
SW1	SW1		1.8-V	PIN_B23

■ User-Defined LEDs

The FPGA board consists of 4 user-controllable LEDs to allow status and debugging signals to be driven to the LEDs from the designs loaded into the Stratix 10 GX/SX device. Each LED is driven directly by the Stratix 10 GX/SX FPGA. The LED is turned on or off when the associated pins are driven to a low or high logic level, respectively. A list of the pin names on the FPGA that are connected to the LEDs is given in **Table 2-5**.

Table 2-5 User LEDs Pin Assignments, Schematic Signal Names, and Functions

Board Reference	Schematic Signal Name	Description	I/O Standard	Stratix 10 GX/SX Pin Number
LED0	LED0	Driving a logic 0 on the I/O port turns the LED ON.	1.8-V	PIN_B24
LED1	LED1		1.8-V	PIN_A24
LED2	LED2	Driving a logic 1 on the I/O port turns the LED OFF.	1.8-V	PIN_A25
LED3	LED3		1.8-V	PIN_A26

■ 2x5 GPIO Header (Timing Expansion Header)

The FPGA board has one 2x5 GPIO header J5 for expansion function. The pin-out of J5 is shown in **Figure 2-7**. GPIO_P0 ~ GPIO_P3 are bi-direction 1.8V GPIO.

GPIO_CLK0 and GPIO_CLK1 are connected to FPGA dedicated clock input and can be configured as two single-ended clock signals. Users can use Terasic defined RS422-RJ45 board and TUB (Timing and UART Board) for RS422 and external clock inputs/UART applications.

Table 2-6 shows the mapping of the FPGA pin assignments to the 2x5 GPIO header.

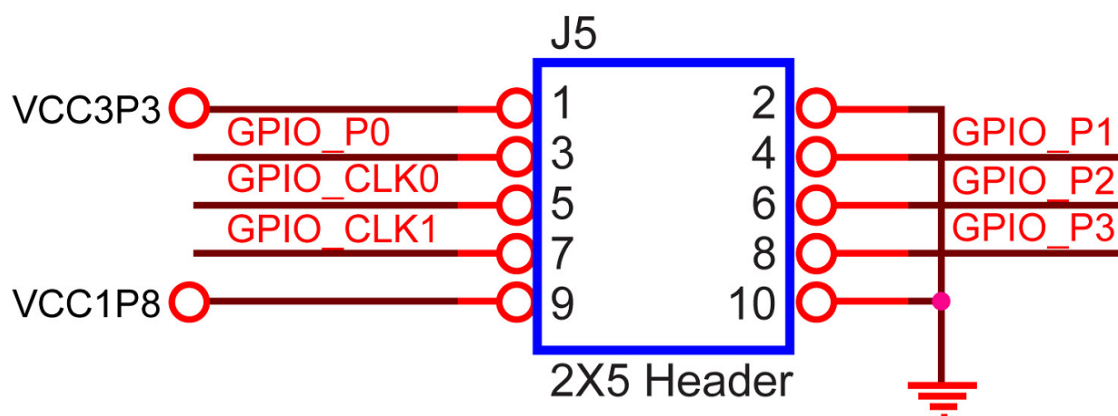

Figure 2-7 Pin-out of 2x5 expansion header J5

Table 2-6 2x5 GPIO Header Pin Assignments, Schematic Signal Names, and Functions

Schematic Signal Name	Description	I/O Standard	Stratix 10 GX/SX Pin Number
GPIO_P0	Bi-direction 1.8V GPIO	1.8-V	PIN_BB25
GPIO_P1	Bi-direction 1.8V GPIO	1.8-V	PIN_BC26
GPIO_P2	Bi-direction 1.8V GPIO	1.8-V	PIN_BC25
GPIO_P3	Bi-direction 1.8V GPIO	1.8-V	PIN_BA25
GPIO_CLK0	FPGA dedicated clock input or Bi-direction 1.8V GPIO	1.8-V	PIN_BA27
GPIO_CLK1	FPGA dedicated clock input or Bi-direction 1.8V GPIO	1.8-V	PIN_BA26

2.4 Temperature Sensor and Fan Control

The FPGA board is equipped with a temperature sensor, TMP441AIDCNT, which provides temperature sensing. These functions are accomplished by connecting the

temperature sensor to the internal temperature sensing diode of the Stratix 10 GX/SX device. The temperature status registers of the temperature sensor can be programmed by a two-wire I2C bus, which is connected to the Stratix 10 GX/SX FPGA. In addition, the 7-bit slave address for this sensor is set to '0011100b'. **Figure 2-8** shows the connection between the temperature sensor and the Stratix 10 GX/SX FPGA.

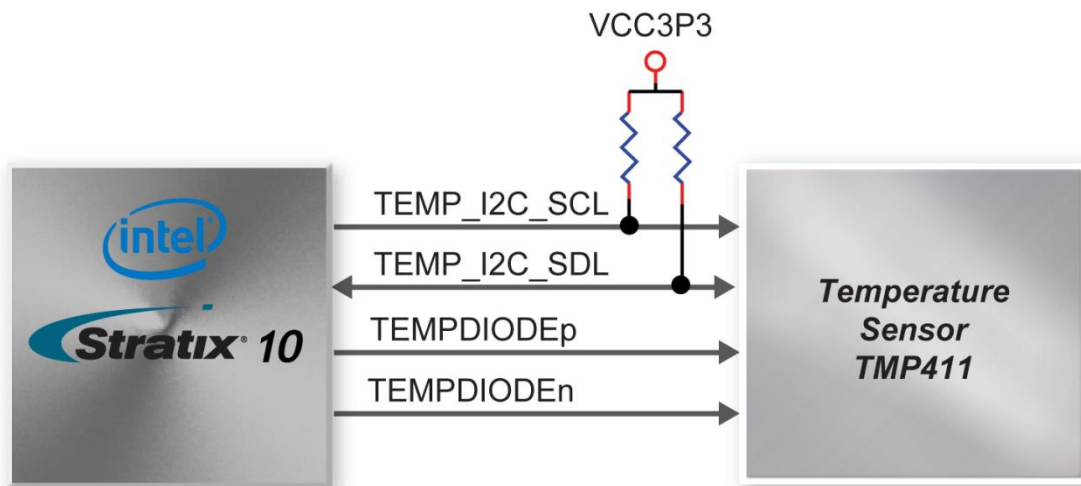

Figure 2-8 Connections between the temperature sensor and FPGA

An optional 4-pin +12V air cooler located on J1 of the FPGA board is intended to reduce the temperature of the FPGA. The board is equipped with a Fan-Speed regulator and monitor, MAX6651, through an I2C interface; users regulate and monitor the speed of the fan depending on the measured system temperature. **Figure 2-9** shows the connection between the Fan-Speed Regulator and Monitor and the Stratix 10 GX/SX FPGA.

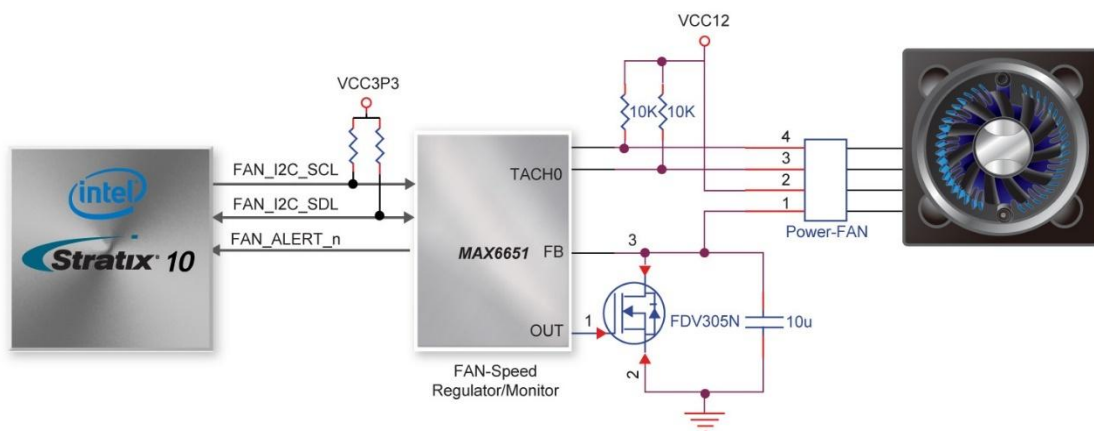

Figure 2-9 Connections between the Fan-Speed Regulator/ Monitor and the Stratix 10 GX/SX FPGA

The pin assignments for the associated interface are listed in [Table 2-7](#).

Table 2-7 Temperature Sensor and Fan Speed Control Pin Assignments, Schematic Signal Names, and Functions

Schematic Signal Name	Description	I/O Standard	Stratix 10 GX/SX Pin Number
TEMPDIODEp0	Positive pin of temperature diode in Stratix 10	-	PIN_BJ24
TEMPDIODEn0	Negative pin of temperature diode in Stratix 10	-	PIN_BG24
TEMP_I2C_SCL	2-Wire Serial Clock	1.8-V	PIN_E22
TEMP_I2C_SDA	2-Wire Serial-Data	1.8-V	PIN_E23
FAN_I2C_SCL	2-Wire Serial Clock	1.8-V	PIN_BD26
FAN_I2C_SDA	2-Wire Serial-Data	1.8-V	PIN_BE27
FAN_ALERT_n	Active-low ALERT input	1.8-V	PIN_BE26

2.5 Power Monitor

The DE10-Pro has implemented two power monitor chips to monitor both board input power and FPGA core power voltage and current. [Figure 2-10](#) shows the connection between the power monitor chip and the Stratix 10 GX/SX FPGA. The two different LTC2945 power monitor chips share the same I2C bus with different I2C address. The power monitor chips monitor both shunt voltage drops and input power voltage allows user to monitor the total board power and FPGA core power consumption. Programmable calibration value, conversion times, and averaging, combined with an internal multiplier, enable direct readouts of current in amperes and power in watts. [Table 2-8](#) shows the pin assignment of the power monitor I2C bus.

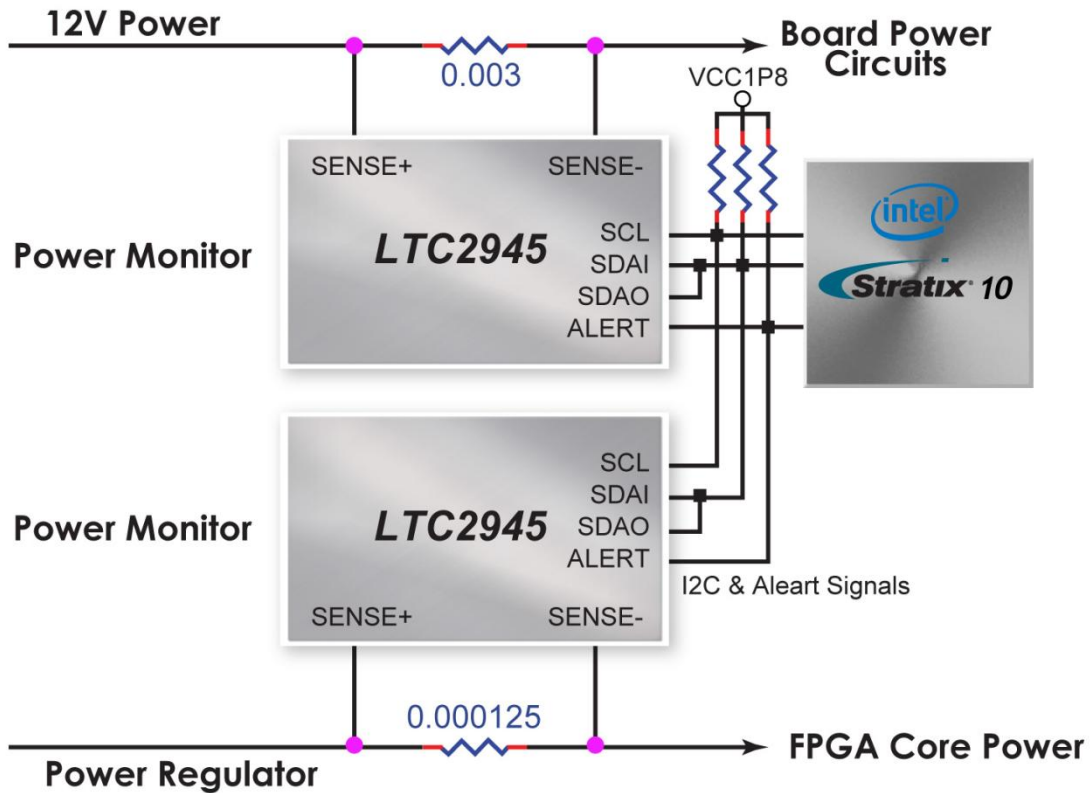

Figure 2-10 Connections between the Power Monitors and FPGA

Table 2-8 Pin Assignment of Power Monitor I2C bus

Schematic Signal Name	Description	I/O Standard	Stratix 10 GX/SX Pin Number
POWER_MONITOR_I2C_SCL	Power Monitor SCL	1.8V	PIN_F24
POWER_MONITOR_I2C_SDA	Power Monitor SDA	1.8V	PIN_F22
POWER_MONITOR_ALERT_n	Power Monitor ALERT	1.8V	PIN_E24

2.6 Clock Circuit

The development board includes one 50 MHz and two programmable clock generators. **Figure 2-11** shows the default frequencies of on-board all external clocks going to the Stratix 10 GX/SX FPGA.

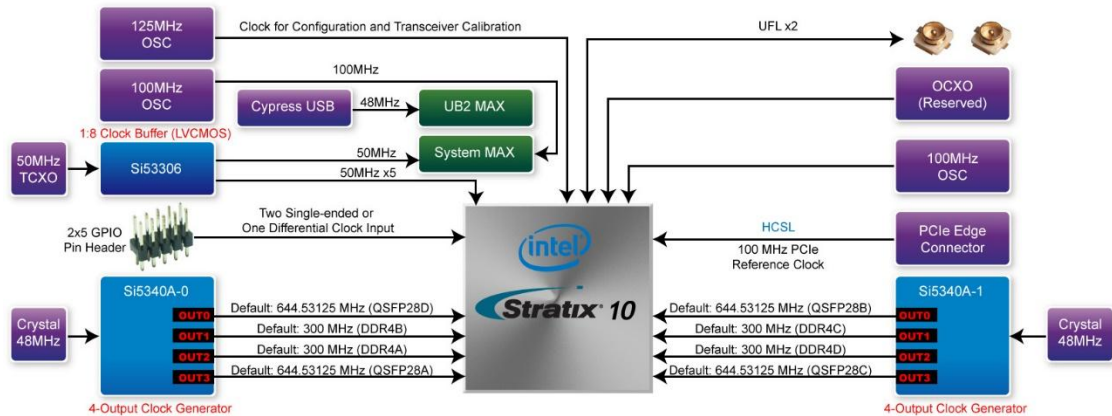

Figure 2-11 Clock circuit of the FPGA Board

A clock buffer is used to duplicate the 50 MHz TCXO output clock, so there are five 50MHz clocks fed into different five FPGA banks. The two programming clock generators with low-jitter clock outputs which are used to provide special and high-quality clock signals for high-speed transceivers and high bandwidth memory. Through I2C serial interface, the clock generator controllers in the Stratix 10 GX/SX FPGA can be used to program these two Si5340As to generate 100G Ethernet QSFP28 and high bandwidth memory reference clocks respectively. Two UFL connectors provide two external single-ended clock inputs or one external differential clock inputs. One oscillator provides a 125 MHz clock used as configuration clock or used as the clock for transceiver calibration. Besides, there is one 100 MHz clock source to use as the FPGA input clock.

Table 2-9 lists the clock source, signal names, default frequency and their corresponding Stratix 10 GX/SX device pin numbers.

Table 2-9 Clock Source, Signal Name, Default Frequency, Pin Assignments and Functions

Source	Schematic Signal Name	Default Frequency	I/O Standard	Stratix 10 GX/SX Pin Number	Application
Y4	CLK_50_B2C	50.0 MHz	1.2V	PIN_AW38	
	CLK_50_B2L		1.2V	PIN_J25	
	CLK_50_B3C		1.2V	PIN_BF21	
	CLK_50_B3L		1.2V	PIN_J20	

	CLK_50_B3I		1.8V	PIN_M24	
Y6	CLK_100_B3I	100.0MHz	1.8V	PIN_U24	
J3	UFL_CLKIN_p	User Defined	1.8V	PIN_AN27	External Clock Input
J2	UFL_CLKIN_n	User Defined	1.8V	PIN_AN28	External Clock Input
U20	QSFP28A_REFCLK_p	644.53125 MHz	LVDS	PIN_T41	100G QSFP28 A port
	QSFP28D_REFCLK_p	644.53125 MHz	LVDS	PIN_T9	100G QSFP28 D port
	DDR4A_REFCLK_p	300 MHz	LVDS	PIN_M35	DDR4 reference clock for A port
	DDR4B_REFCLK_p	300 MHz	LVDS	PIN_J16	DDR4 reference clock for B port
U28	QSFP28B_REFCLK_p	644.53125 MHz	LVDS	PIN_AM38	100G QSFP28 B port
	QSFP28C_REFCLK_p	644.53125 MHz	LVDS	PIN_AM12	100G QSFP28 C port
	DDR4C_REFCLK_p	300 MHz	LVDS	PIN_BH33	DDR4 reference clock for C port
	DDR4D_REFCLK_p	300 MHz	LVDS	PIN_AT17	QDRII+ reference clock for D port

Table 2-10 lists the programmable oscillator control pins, signal names, I/O standard and their corresponding Stratix 10 GX/SX device pin numbers.

Table 2-10 Programmable clock generator control pin, Signal Name, I/O standard, Pin Assignments and Descriptions

Programmable clock generator	Schematic Signal Name	I/O Standard	Stratix 10 GX/SX Pin Number	Description
Si5340A (U20)	Si5340A0_I2C_SCL	1.8-V	PIN_BJ25	I2C bus, connected with Si5340A
	Si5340A0_I2C_SDA	1.8-V	PIN_BJ26	
	Si5340A0_RST_n	1.8-V	PIN_BH27	Si5340A reset signal
	Si5340A0_INTR	1.8-V	PIN_BH26	Si5340A interrupt

				signal
	Si5340A0_OE_n	1.8-V	PIN_BH25	Si5340A output enable signal
Si5340A (U28)	Si5340A1_I2C_SCL	1.8-V	PIN_G22	I2C bus, connected with Si5340A
	Si5340A1_I2C_SDA	1.8-V	PIN_H22	
	Si5340A1_RST_n	1.8-V	PIN_G24	Si5340A reset signal
	Si5340A1_INTR	1.8-V	PIN_H23	Si5340A interrupt signal
	Si5340A1_OE_n	1.8-V	PIN_G23	Si5340A output enable signal

2.7 FLASH Memory

The development board has one 1Gb CFI-compatible synchronous flash devices for non-volatile storage of FPGA configuration data, user application data, and user code space.

The flash has a 16-bit data bus allowing for Avalon-ST x8 configuration. This device is part of the shared flash and MAX (FM) bus, which connects to the flash memory and MAX V CPLD (5M2210) System Controller. **Figure 2-12** shows the connections between the Flash, MAX and Stratix 10 GX/SX FPGA.

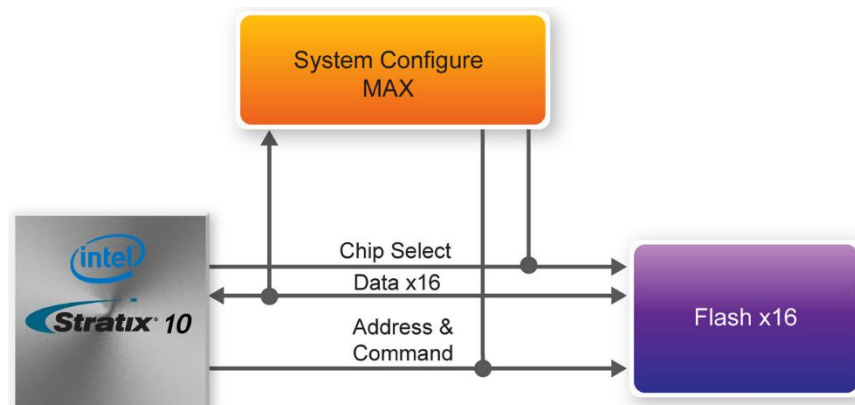

Figure 2-12 Connection between the Flash, Max and Stratix 10 GX/SX FPGA

Table 2-11 lists the flash pin assignments, signal names, and functions.

Table 2-11 Flash Memory Pin Assignments, Schematic Signal Names, and Functions

Schematic Signal Name	Description	I/O Standard	Stratix 10 GX/SX Pin Number
FLASH_A1	Address bus	1.8-V	PIN_V22
FLASH_A2	Address bus	1.8-V	PIN_P23
FLASH_A3	Address bus	1.8-V	PIN_K22
FLASH_A4	Address bus	1.8-V	PIN_R21
FLASH_A5	Address bus	1.8-V	PIN_K24
FLASH_A6	Address bus	1.8-V	PIN_K23
FLASH_A7	Address bus	1.8-V	PIN_R24
FLASH_A8	Address bus	1.8-V	PIN_AR28
FLASH_A9	Address bus	1.8-V	PIN_AR27
FLASH_A10	Address bus	1.8-V	PIN_AN26
FLASH_A11	Address bus	1.8-V	PIN_AP26
FLASH_A12	Address bus	1.8-V	PIN_AN25
FLASH_A13	Address bus	1.8-V	PIN_AU27
FLASH_A14	Address bus	1.8-V	PIN_AP28
FLASH_A15	Address bus	1.8-V	PIN_AT27
FLASH_A16	Address bus	1.8-V	PIN_AY28
FLASH_A17	Address bus	1.8-V	PIN_AY26
FLASH_A18	Address bus	1.8-V	PIN_AP30
FLASH_A19	Address bus	1.8-V	PIN_AW25
FLASH_A20	Address bus	1.8-V	PIN_BB27
FLASH_A21	Address bus	1.8-V	PIN_AT26
FLASH_A22	Address bus	1.8-V	PIN_AP31
FLASH_A23	Address bus	1.8-V	PIN_P24
FLASH_A24	Address bus	1.8-V	PIN_AV26
FLASH_A25	Address bus	1.8-V	PIN_AV27
FLASH_A26	Address bus	1.8-V	PIN_AP29
FLASH_A27	Address bus	1.8-V	PIN_N22
FLASH_D0	Data bus	1.8-V	PIN_N23

FLASH_D1	Data bus	1.8-V	PIN_R22
FLASH_D2	Data bus	1.8-V	PIN_U20
FLASH_D3	Data bus	1.8-V	PIN_L22
FLASH_D4	Data bus	1.8-V	PIN_J23
FLASH_D5	Data bus	1.8-V	PIN_U22
FLASH_D6	Data bus	1.8-V	PIN_V23
FLASH_D7	Data bus	1.8-V	PIN_V21
FLASH_D8	Data bus	1.8-V	PIN_M23
FLASH_D9	Data bus	1.8-V	PIN_R23
FLASH_D10	Data bus	1.8-V	PIN_T20
FLASH_D11	Data bus	1.8-V	PIN_V24
FLASH_D12	Data bus	1.8-V	PIN_M22
FLASH_D13	Data bus	1.8-V	PIN_T22
FLASH_D14	Data bus	1.8-V	PIN_T21
FLASH_D15	Data bus	1.8-V	PIN_J24
FLASH_CLK	Clock	1.8-V	PIN_U23
FLASH_RESET_n	Reset	1.8-V	PIN_AP25
FLASH_CE_n	Chip enable	1.8-V	PIN_AR26
FLASH_OE_n	Output enable	1.8-V	PIN_AV25
FLASH_WE_n	Write enable	1.8-V	PIN_AT25
FLASH_ADV_n	Address valid	1.8-V	PIN_AU25
FLASH_RDY_BSY_n	Ready of flash-0	1.8-V	PIN_AW26

2.8 DDR4 SO-DIMM

The development board supports four independent banks of DDR4 SDRAM SO-DIMM. Each DDR4 SODIMM socket is wired to support a maximum capacity of 8GB with ECC. Using differential DQS signaling for the DDR4 SDRAM interfaces, it is capable of running at up to 1333MHz memory clock for a maximum theoretical bandwidth up to 153.6Gbps. The memory clock of DDR4 SDRAM is up to 1333MHz while the FPGA fabric speed grade is 1, and the memory clock is up to 1200MHz while the FPGA fabric speed grade is 2. **Figure 2-13** shows the connections between the DDR4 SDRAM SO-DIMMs and Stratix 10 GX/SX FPGA.

For better flexibility in use, these four DDR4 SO-DIMM sockets also support QDRII+ SRAM and QDR-IV SRAM module designed by Terasic. By using two ID pins on DDR4, QDRII+ and QDR-IV modules, the DE10-Pro will automatically identify the memory module type and set proper VDD and VDDQ voltage for normal operation of memory. Each QDRII+ SO-DIMM module supports up to 576Mbits with 36-bit data width and 550 MHz clock frequency. Each QDR-IV supports up to 144Mbits with 36-bit data width and 1066 MHz clock frequency. The four DDR4 SO-DIMM sockets are divided into right and left groups. The two SO-DIMM sockets in the same group must be inserted with the same memory to prevent dysfunction on memory module that requires higher voltage. Two different memory modules can be inserted separately in right & left groups. For example, users can insert two DDR4 modules on the right side and two QDRII+ SRAM modules (or two QDR-IV SRAM modules) on the left side as shown in **Figure 2-14**.

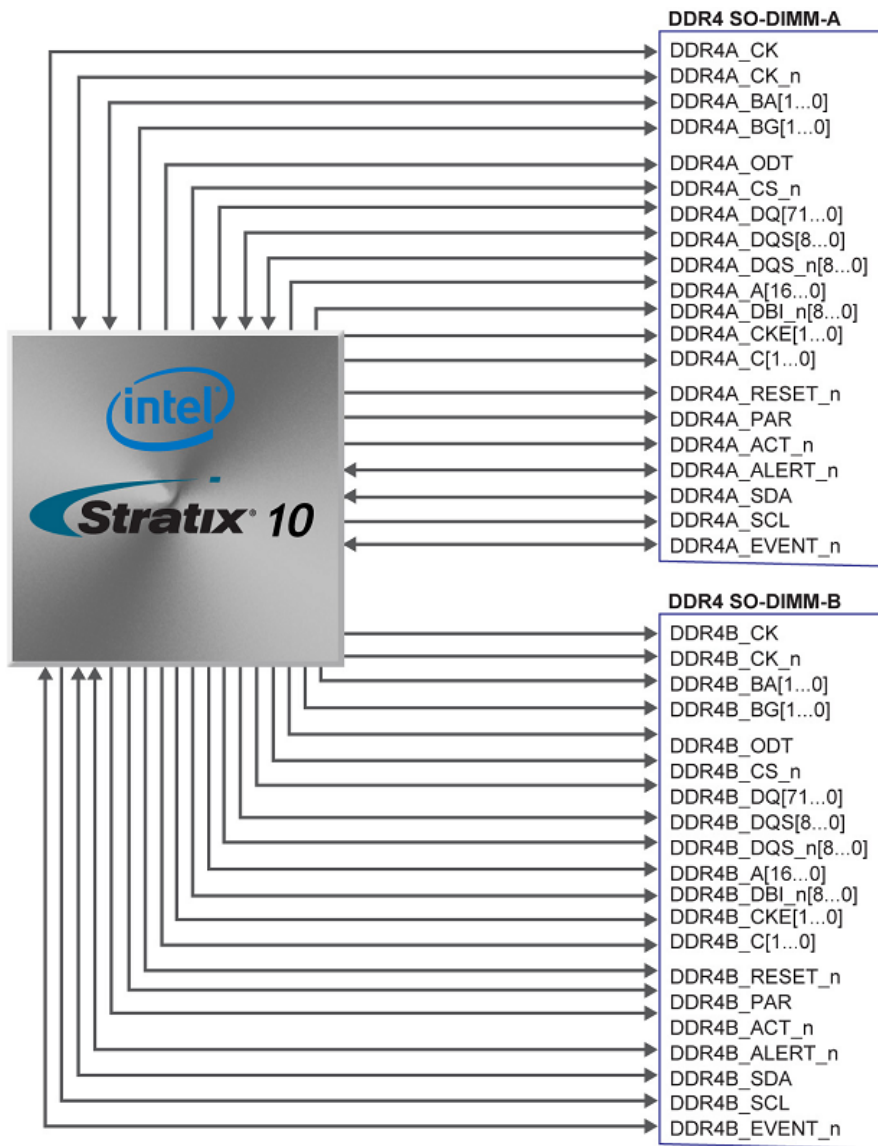
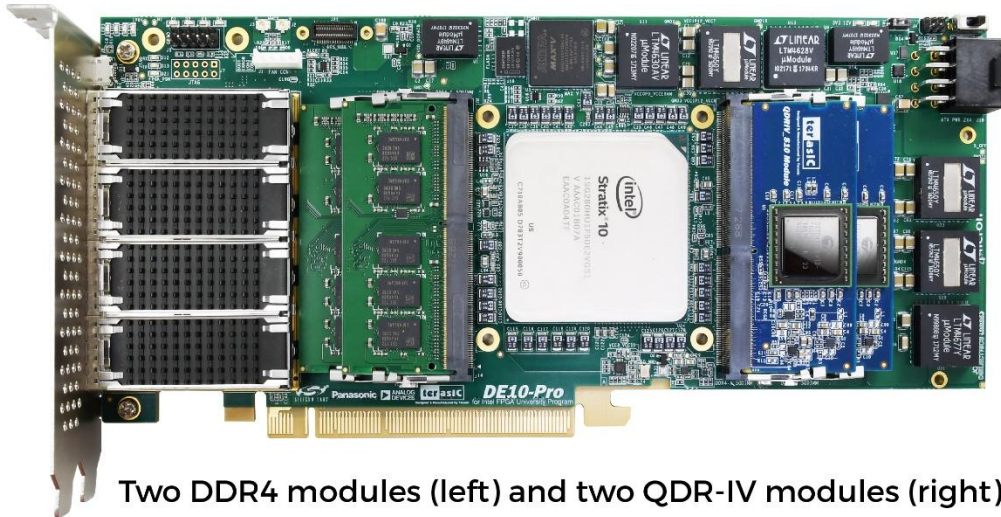
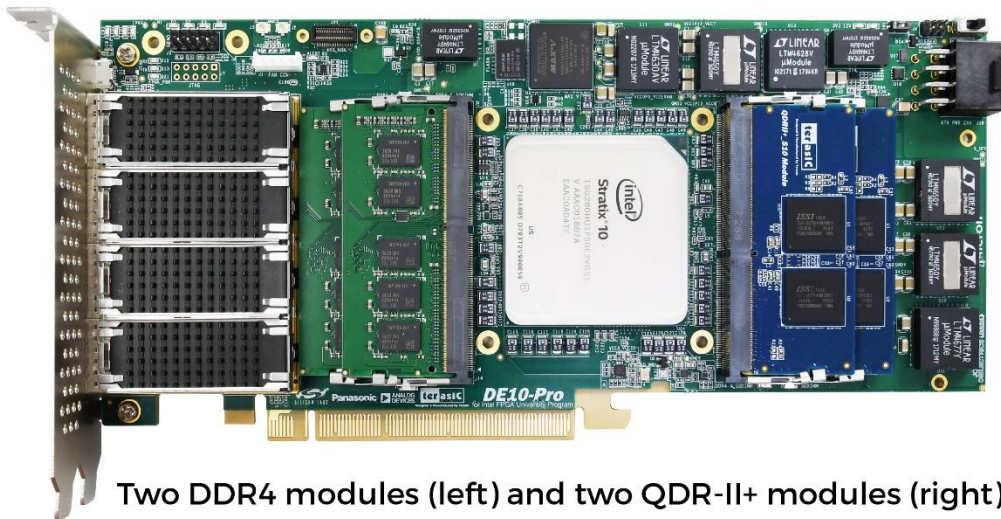

Figure 2-13 Connection between the DDR4 and Stratix 10 GX/SX FPGA



Two DDR4 modules (left) and two QDR-IV modules (right)



Two DDR4 modules (left) and two QDR-II+ modules (right)

Figure 2-14 Two memory module insertion examples

The pin assignments for DDR4 SDRAM SO-DIMM Bank-A, Bank-B, Bank-C and Bank-D are listed in [Table 2-12](#), [Table 2-13](#), [Table 2-14](#) and [Table 2-15](#) respectively. For QDRII+ and QDR-IV SO-DIMM module applications please refer to our example codes in DE10-Pro CD-ROM.

Table 2-12 DDR4-A Bank Pin Assignments, Schematic Signal Names, and Functions

Schematic Signal Name	Description	I/O Standard	Stratix 10 GX/SX Pin Number
DDR4A_DQ0	Data [0]	1.2-V POD	PIN_A37

DDR4A_DQ1	Data [1]	1.2-V POD	PIN_B37
DDR4A_DQ2	Data [2]	1.2-V POD	PIN_B35
DDR4A_DQ3	Data [3]	1.2-V POD	PIN_C37
DDR4A_DQ4	Data [4]	1.2-V POD	PIN_B38
DDR4A_DQ5	Data [5]	1.2-V POD	PIN_C38
DDR4A_DQ6	Data [6]	1.2-V POD	PIN_C35
DDR4A_DQ7	Data [7]	1.2-V POD	PIN_D36
DDR4A_DQ8	Data [8]	1.2-V POD	PIN_H37
DDR4A_DQ9	Data [9]	1.2-V POD	PIN_E39
DDR4A_DQ10	Data [10]	1.2-V POD	PIN_E37
DDR4A_DQ11	Data [11]	1.2-V POD	PIN_D35
DDR4A_DQ12	Data [12]	1.2-V POD	PIN_E38
DDR4A_DQ13	Data [13]	1.2-V POD	PIN_D38
DDR4A_DQ14	Data [14]	1.2-V POD	PIN_D34
DDR4A_DQ15	Data [15]	1.2-V POD	PIN_F37
DDR4A_DQ16	Data [16]	1.2-V POD	PIN_F35
DDR4A_DQ17	Data [17]	1.2-V POD	PIN_J36
DDR4A_DQ18	Data [18]	1.2-V POD	PIN_J35
DDR4A_DQ19	Data [19]	1.2-V POD	PIN_E34
DDR4A_DQ20	Data [20]	1.2-V POD	PIN_G35
DDR4A_DQ21	Data [21]	1.2-V POD	PIN_H36
DDR4A_DQ22	Data [22]	1.2-V POD	PIN_H35
DDR4A_DQ23	Data [23]	1.2-V POD	PIN_H33
DDR4A_DQ24	Data [24]	1.2-V POD	PIN_N32
DDR4A_DQ25	Data [25]	1.2-V POD	PIN_M33
DDR4A_DQ26	Data [26]	1.2-V POD	PIN_K34
DDR4A_DQ27	Data [27]	1.2-V POD	PIN_M34
DDR4A_DQ28	Data [28]	1.2-V POD	PIN_N33
DDR4A_DQ29	Data [29]	1.2-V POD	PIN_N31
DDR4A_DQ30	Data [30]	1.2-V POD	PIN_K33
DDR4A_DQ31	Data [31]	1.2-V POD	PIN_K32
DDR4A_DQ32	Data [32]	1.2-V POD	PIN_M25
DDR4A_DQ33	Data [33]	1.2-V POD	PIN_P25
DDR4A_DQ34	Data [34]	1.2-V POD	PIN_T25

DDR4A_DQ35	Data [35]	1.2-V POD	PIN_R26
DDR4A_DQ36	Data [36]	1.2-V POD	PIN_L25
DDR4A_DQ37	Data [37]	1.2-V POD	PIN_N27
DDR4A_DQ38	Data [38]	1.2-V POD	PIN_U25
DDR4A_DQ39	Data [39]	1.2-V POD	PIN_P26
DDR4A_DQ40	Data [40]	1.2-V POD	PIN_U27
DDR4A_DQ41	Data [41]	1.2-V POD	PIN_T29
DDR4A_DQ42	Data [42]	1.2-V POD	PIN_V25
DDR4A_DQ43	Data [43]	1.2-V POD	PIN_U29
DDR4A_DQ44	Data [44]	1.2-V POD	PIN_U28
DDR4A_DQ45	Data [45]	1.2-V POD	PIN_T30
DDR4A_DQ46	Data [46]	1.2-V POD	PIN_V26
DDR4A_DQ47	Data [47]	1.2-V POD	PIN_U30
DDR4A_DQ48	Data [48]	1.2-V POD	PIN_F25
DDR4A_DQ49	Data [49]	1.2-V POD	PIN_K27
DDR4A_DQ50	Data [50]	1.2-V POD	PIN_L27
DDR4A_DQ51	Data [51]	1.2-V POD	PIN_H26
DDR4A_DQ52	Data [52]	1.2-V POD	PIN_H25
DDR4A_DQ53	Data [53]	1.2-V POD	PIN_H27
DDR4A_DQ54	Data [54]	1.2-V POD	PIN_M27
DDR4A_DQ55	Data [55]	1.2-V POD	PIN_G25
DDR4A_DQ56	Data [56]	1.2-V POD	PIN_D26
DDR4A_DQ57	Data [57]	1.2-V POD	PIN_B27
DDR4A_DQ58	Data [58]	1.2-V POD	PIN_G27
DDR4A_DQ59	Data [59]	1.2-V POD	PIN_B25
DDR4A_DQ60	Data [60]	1.2-V POD	PIN_C27
DDR4A_DQ61	Data [61]	1.2-V POD	PIN_C26
DDR4A_DQ62	Data [62]	1.2-V POD	PIN_F27
DDR4A_DQ63	Data [63]	1.2-V POD	PIN_D25
DDR4A_DQ64	Data [64]	1.2-V POD	PIN_R31
DDR4A_DQ65	Data [65]	1.2-V POD	PIN_T34
DDR4A_DQ66	Data [66]	1.2-V POD	PIN_R34
DDR4A_DQ67	Data [67]	1.2-V POD	PIN_P33
DDR4A_DQ68	Data [68]	1.2-V POD	PIN_T31

DDR4A_DQ69	Data [69]	1.2-V POD	PIN_U33
DDR4A_DQ70	Data [70]	1.2-V POD	PIN_V32
DDR4A_DQ71	Data [71]	1.2-V POD	PIN_U32
DDR4A_DQS0	Data Strobe p[0]	DIFFERENTIAL 1.2-V POD	PIN_A36
DDR4A_DQS_n0	Data Strobe n[0]	DIFFERENTIAL 1.2-V POD	PIN_A35
DDR4A_DQS1	Data Strobe p[1]	DIFFERENTIAL 1.2-V POD	PIN_E36
DDR4A_DQS_n1	Data Strobe n[1]	DIFFERENTIAL 1.2-V POD	PIN_F36
DDR4A_DQS2	Data Strobe p[2]	DIFFERENTIAL 1.2-V POD	PIN_G33
DDR4A_DQS_n2	Data Strobe n[2]	DIFFERENTIAL 1.2-V POD	PIN_G34
DDR4A_DQS3	Data Strobe p[3]	DIFFERENTIAL 1.2-V POD	PIN_L32
DDR4A_DQS_n3	Data Strobe n[3]	DIFFERENTIAL 1.2-V POD	PIN_L31
DDR4A_DQS4	Data Strobe p[4]	DIFFERENTIAL 1.2-V POD	PIN_T26
DDR4A_DQS_n4	Data Strobe n[4]	DIFFERENTIAL 1.2-V POD	PIN_R27
DDR4A_DQS5	Data Strobe p[5]	DIFFERENTIAL 1.2-V POD	PIN_V28
DDR4A_DQS_n5	Data Strobe n[5]	DIFFERENTIAL 1.2-V POD	PIN_V27
DDR4A_DQS6	Data Strobe p[6]	DIFFERENTIAL 1.2-V POD	PIN_J26
DDR4A_DQS_n6	Data Strobe n[6]	DIFFERENTIAL 1.2-V POD	PIN_K26
DDR4A_DQS7	Data Strobe p[7]	DIFFERENTIAL 1.2-V POD	PIN_E26
DDR4A_DQS_n7	Data Strobe n[7]	DIFFERENTIAL 1.2-V POD	PIN_F26

DDR4A_DQS8	Data Strobe p[8]	DIFFERENTIAL 1.2-V POD	PIN_R32
DDR4A_DQS_n8	Data Strobe n[8]	DIFFERENTIAL 1.2-V POD	PIN_T32
DDR4A_DBI_n0	Data Bus Inversion [0]	1.2-V POD	PIN_C36
DDR4A_DBI_n1	Data Bus Inversion [1]	1.2-V POD	PIN_D39
DDR4A_DBI_n2	Data Bus Inversion [2]	1.2-V POD	PIN_F34
DDR4A_DBI_n3	Data Bus Inversion [3]	1.2-V POD	PIN_J34
DDR4A_DBI_n4	Data Bus Inversion [4]	1.2-V POD	PIN_N25
DDR4A_DBI_n5	Data Bus Inversion [5]	1.2-V POD	PIN_V30
DDR4A_DBI_n6	Data Bus Inversion [6]	1.2-V POD	PIN_L26
DDR4A_DBI_n7	Data Bus Inversion [7]	1.2-V POD	PIN_E27
DDR4A_DBI_n8	Data Bus Inversion [8]	1.2-V POD	PIN_U34
DDR4A_A0	Address [0]	SSTL-12	PIN_K38
DDR4A_A1	Address [1]	SSTL-12	PIN_L37
DDR4A_A2	Address [2]	SSTL-12	PIN_M37
DDR4A_A3	Address [3]	SSTL-12	PIN_M38
DDR4A_A4	Address [4]	SSTL-12	PIN_J39
DDR4A_A5	Address [5]	SSTL-12	PIN_J38
DDR4A_A6	Address [6]	SSTL-12	PIN_K39
DDR4A_A7	Address [7]	SSTL-12	PIN_L39
DDR4A_A8	Address [8]	SSTL-12	PIN_P37
DDR4A_A9	Address [9]	SSTL-12	PIN_R37
DDR4A_A10	Address [10]	SSTL-12	PIN_N37
DDR4A_A11	Address [11]	SSTL-12	PIN_P38

DDR4A_A12	Address [12]	SSTL-12	PIN_P35
DDR4A_A13	Address [13]	SSTL-12	PIN_K36
DDR4A_A14	Address [14]/ WE_n	SSTL-12	PIN_K37
DDR4A_A15	Address [15]/ CAS_n	SSTL-12	PIN_N36
DDR4A_A16	Address [16]/ RAS_n	SSTL-12	PIN_P36
DDR4A_BA0	Bank Select [0]	SSTL-12	PIN_L36
DDR4A_BA1	Bank Select [1]	SSTL-12	PIN_T35
DDR4A_BG0	Bank Group Select [0]	SSTL-12	PIN_R36
DDR4A_BG1	Bank Group Select [1]	SSTL-12	PIN_D40
DDR4A_C0	Chip ID 0	SSTL-12	PIN_F40
DDR4A_C1	Chip ID 1	SSTL-12	PIN_K40
DDR4A_CK	Clock p	DIFFERENTIAL 1.2-V SSTL	PIN_F39
DDR4A_CK_n	Clock n	DIFFERENTIAL 1.2-V SSTL	PIN_G39
DDR4A_CKE	Clock Enable pin	SSTL-12	PIN_L40
DDR4A_ODT	On Die Termination	SSTL-12	PIN_G40
DDR4A_CS_n	Chip Select	SSTL-12	PIN_G38
DDR4A_PAR	Command and Address Parity Input	SSTL-12	PIN_H40
DDR4A_ALERT_n	Register ALERT_n output	1.2 V	PIN_A38
DDR4A_ACT_n	Activation Command Input	SSTL-12	PIN_H38
DDR4A_RESET_n	Chip Reset	1.2 V	PIN_E40
DDR4A_EVENT_n	Chip Temperature Event	1.2 V	PIN_J33
DDR4A_SDA	Chip I2C Serial	1.2 V	PIN_T24

	Data Bus		
DDR4A_SCL	Chip I2C Serial Clock	1.2 V	PIN_L24
DDR4A_REFCLK_p	DDR4 A port Reference Clock p	LVDS	PIN_M35
DDR4A_REFCLK_n	DDR4 A port Reference Clock n	LVDS	PIN_N35

Table 2-13 DDR4-B Pin Assignments, Schematic Signal Names, and Functions

Schematic Signal Name	Description	I/O Standard	Stratix 10 GX/SX Pin Number
DDR4B_DQ0	Data [0]	1.2-V POD	PIN_T16
DDR4B_DQ1	Data [1]	1.2-V POD	PIN_V18
DDR4B_DQ2	Data [2]	1.2-V POD	PIN_R19
DDR4B_DQ3	Data [3]	1.2-V POD	PIN_U18
DDR4B_DQ4	Data [4]	1.2-V POD	PIN_U19
DDR4B_DQ5	Data [5]	1.2-V POD	PIN_W18
DDR4B_DQ6	Data [6]	1.2-V POD	PIN_R18
DDR4B_DQ7	Data [7]	1.2-V POD	PIN_V17
DDR4B_DQ8	Data [8]	1.2-V POD	PIN_P16
DDR4B_DQ9	Data [9]	1.2-V POD	PIN_P14
DDR4B_DQ10	Data [10]	1.2-V POD	PIN_P15
DDR4B_DQ11	Data [11]	1.2-V POD	PIN_R13
DDR4B_DQ12	Data [12]	1.2-V POD	PIN_R17
DDR4B_DQ13	Data [13]	1.2-V POD	PIN_N13
DDR4B_DQ14	Data [14]	1.2-V POD	PIN_R14
DDR4B_DQ15	Data [15]	1.2-V POD	PIN_M13
DDR4B_DQ16	Data [16]	1.2-V POD	PIN_J11
DDR4B_DQ17	Data [17]	1.2-V POD	PIN_K10
DDR4B_DQ18	Data [18]	1.2-V POD	PIN_K11
DDR4B_DQ19	Data [19]	1.2-V POD	PIN_J13
DDR4B_DQ20	Data [20]	1.2-V POD	PIN_K13
DDR4B_DQ21	Data [21]	1.2-V POD	PIN_L10

DDR4B_DQ22	Data [22]	1.2-V POD	PIN_K12
DDR4B_DQ23	Data [23]	1.2-V POD	PIN_H11
DDR4B_DQ24	Data [24]	1.2-V POD	PIN_F10
DDR4B_DQ25	Data [25]	1.2-V POD	PIN_E10
DDR4B_DQ26	Data [26]	1.2-V POD	PIN_H10
DDR4B_DQ27	Data [27]	1.2-V POD	PIN_F12
DDR4B_DQ28	Data [28]	1.2-V POD	PIN_G10
DDR4B_DQ29	Data [29]	1.2-V POD	PIN_F11
DDR4B_DQ30	Data [30]	1.2-V POD	PIN_E11
DDR4B_DQ31	Data [31]	1.2-V POD	PIN_E12
DDR4B_DQ32	Data [32]	1.2-V POD	PIN_N20
DDR4B_DQ33	Data [33]	1.2-V POD	PIN_H21
DDR4B_DQ34	Data [34]	1.2-V POD	PIN_P21
DDR4B_DQ35	Data [35]	1.2-V POD	PIN_K19
DDR4B_DQ36	Data [36]	1.2-V POD	PIN_K21
DDR4B_DQ37	Data [37]	1.2-V POD	PIN_J21
DDR4B_DQ38	Data [38]	1.2-V POD	PIN_N21
DDR4B_DQ39	Data [39]	1.2-V POD	PIN_L19
DDR4B_DQ40	Data [40]	1.2-V POD	PIN_H18
DDR4B_DQ41	Data [41]	1.2-V POD	PIN_G19
DDR4B_DQ42	Data [42]	1.2-V POD	PIN_J18
DDR4B_DQ43	Data [43]	1.2-V POD	PIN_G20
DDR4B_DQ44	Data [44]	1.2-V POD	PIN_G18
DDR4B_DQ45	Data [45]	1.2-V POD	PIN_F19
DDR4B_DQ46	Data [46]	1.2-V POD	PIN_K18
DDR4B_DQ47	Data [47]	1.2-V POD	PIN_H20
DDR4B_DQ48	Data [48]	1.2-V POD	PIN_E17
DDR4B_DQ49	Data [49]	1.2-V POD	PIN_D21
DDR4B_DQ50	Data [50]	1.2-V POD	PIN_E18
DDR4B_DQ51	Data [51]	1.2-V POD	PIN_C22
DDR4B_DQ52	Data [52]	1.2-V POD	PIN_D19
DDR4B_DQ53	Data [53]	1.2-V POD	PIN_F17
DDR4B_DQ54	Data [54]	1.2-V POD	PIN_D18
DDR4B_DQ55	Data [55]	1.2-V POD	PIN_C21

DDR4B_DQ56	Data [56]	1.2-V POD	PIN_B20
DDR4B_DQ57	Data [57]	1.2-V POD	PIN_B18
DDR4B_DQ58	Data [58]	1.2-V POD	PIN_B22
DDR4B_DQ59	Data [59]	1.2-V POD	PIN_A17
DDR4B_DQ60	Data [60]	1.2-V POD	PIN_B19
DDR4B_DQ61	Data [61]	1.2-V POD	PIN_A20
DDR4B_DQ62	Data [62]	1.2-V POD	PIN_A22
DDR4B_DQ63	Data [63]	1.2-V POD	PIN_A19
DDR4B_DQ64	Data [64]	1.2-V POD	PIN_P18
DDR4B_DQ65	Data [65]	1.2-V POD	PIN_K16
DDR4B_DQ66	Data [66]	1.2-V POD	PIN_M15
DDR4B_DQ67	Data [67]	1.2-V POD	PIN_M18
DDR4B_DQ68	Data [68]	1.2-V POD	PIN_N16
DDR4B_DQ69	Data [69]	1.2-V POD	PIN_L16
DDR4B_DQ70	Data [70]	1.2-V POD	PIN_N18
DDR4B_DQ71	Data [71]	1.2-V POD	PIN_M17
DDR4B_DQS0	Data Strobe p[0]	DIFFERENTIAL 1.2-V POD	PIN_U17
DDR4B_DQS_n0	Data Strobe n[0]	DIFFERENTIAL 1.2-V POD	PIN_T17
DDR4B_DQS1	Data Strobe p[1]	DIFFERENTIAL 1.2-V POD	PIN_P12
DDR4B_DQS_n1	Data Strobe n[1]	DIFFERENTIAL 1.2-V POD	PIN_P13
DDR4B_DQS2	Data Strobe p[2]	DIFFERENTIAL 1.2-V POD	PIN_L12
DDR4B_DQS_n2	Data Strobe n[2]	DIFFERENTIAL 1.2-V POD	PIN_M12
DDR4B_DQS3	Data Strobe p[3]	DIFFERENTIAL 1.2-V POD	PIN_H12
DDR4B_DQS_n3	Data Strobe n[3]	DIFFERENTIAL 1.2-V POD	PIN_G12
DDR4B_DQS4	Data Strobe p[4]	DIFFERENTIAL 1.2-V POD	PIN_M20

DDR4B_DQS_n4	Data Strobe n[4]	DIFFERENTIAL 1.2-V POD	PIN_L20
DDR4B_DQS5	Data Strobe p[5]	DIFFERENTIAL 1.2-V POD	PIN_F20
DDR4B_DQS_n5	Data Strobe n[5]	DIFFERENTIAL 1.2-V POD	PIN_F21
DDR4B_DQS6	Data Strobe p[6]	DIFFERENTIAL 1.2-V POD	PIN_D20
DDR4B_DQS_n6	Data Strobe n[6]	DIFFERENTIAL 1.2-V POD	PIN_C20
DDR4B_DQS7	Data Strobe p[7]	DIFFERENTIAL 1.2-V POD	PIN_C17
DDR4B_DQS_n7	Data Strobe n[7]	DIFFERENTIAL 1.2-V POD	PIN_C18
DDR4B_DQS8	Data Strobe p[8]	DIFFERENTIAL 1.2-V POD	PIN_L17
DDR4B_DQS_n8	Data Strobe n[8]	DIFFERENTIAL 1.2-V POD	PIN_K17
DDR4B_DBI_n0	Data Bus Inversion [0]	1.2-V POD	PIN_T19
DDR4B_DBI_n1	Data Bus Inversion [1]	1.2-V POD	PIN_M14
DDR4B_DBI_n2	Data Bus Inversion [2]	1.2-V POD	PIN_J10
DDR4B_DBI_n3	Data Bus Inversion [3]	1.2-V POD	PIN_D11
DDR4B_DBI_n4	Data Bus Inversion [4]	1.2-V POD	PIN_L21
DDR4B_DBI_n5	Data Bus Inversion [5]	1.2-V POD	PIN_J19
DDR4B_DBI_n6	Data Bus Inversion [6]	1.2-V POD	PIN_E19
DDR4B_DBI_n7	Data Bus Inversion [7]	1.2-V POD	PIN_A21
DDR4B_DBI_n8	Data Bus Inversion	1.2-V POD	PIN_N15

	[8]		
DDR4B_A0	Address [0]	SSTL-12	PIN_C16
DDR4B_A1	Address [1]	SSTL-12	PIN_D16
DDR4B_A2	Address [2]	SSTL-12	PIN_A14
DDR4B_A3	Address [3]	SSTL-12	PIN_A15
DDR4B_A4	Address [4]	SSTL-12	PIN_B14
DDR4B_A5	Address [5]	SSTL-12	PIN_B13
DDR4B_A6	Address [6]	SSTL-12	PIN_A16
DDR4B_A7	Address [7]	SSTL-12	PIN_B15
DDR4B_A8	Address [8]	SSTL-12	PIN_C15
DDR4B_A9	Address [9]	SSTL-12	PIN_D15
DDR4B_A10	Address [10]	SSTL-12	PIN_E16
DDR4B_A11	Address [11]	SSTL-12	PIN_F16
DDR4B_A12	Address [12]	SSTL-12	PIN_L14
DDR4B_A13	Address [13]	SSTL-12	PIN_H15
DDR4B_A14	Address [14]/ WE_n	SSTL-12	PIN_J15
DDR4B_A15	Address [15]/ CAS_n	SSTL-12	PIN_G15
DDR4B_A16	Address [16]/ RAS_n	SSTL-12	PIN_F15
DDR4B_BA0	Bank Select [0]	SSTL-12	PIN_H17
DDR4B_BA1	Bank Select [1]	SSTL-12	PIN_K14
DDR4B_BG0	Bank Group Select [0]	SSTL-12	PIN_J14
DDR4B_BG1	Bank Group Select [1]	SSTL-12	PIN_G13
DDR4B_C0	Chip ID 0	SSTL-12	PIN_F14
DDR4B_C1	Chip ID 1	SSTL-12	PIN_C12
DDR4B_CK	Clock p	DIFFERENTIAL 1.2-V SSTL	PIN_E14
DDR4B_CK_n	Clock n	DIFFERENTIAL 1.2-V SSTL	PIN_D14
DDR4B_CKE	Clock Enable pin	SSTL-12	PIN_C13

DDR4B_ODT	On Die Termination	SSTL-12	PIN_G14
DDR4B_CS_n	Chip Select	SSTL-12	PIN_E13
DDR4B_PAR	Command and Address Parity Input	SSTL-12	PIN_A12
DDR4B_ALERT_n	Register ALERT_n output	1.2 V	PIN_T15
DDR4B_ACT_n	Activation Command Input	SSTL-12	PIN_D13
DDR4B_RESET_n	Chip Reset	1.2 V	PIN_H13
DDR4B_EVENT_n	Chip Temperature Event	1.2 V	PIN_L11
DDR4B_SDA	Chip I2C Serial Data Bus	1.2 V	PIN_P20
DDR4B_SCL	Chip I2C Serial Clock	1.2 V	PIN_D10
DDR4B_REFCLK_p	DDR4 B port Reference Clock p	LVDS	PIN_J16
DDR4B_REFCLK_n	DDR4 B port Reference Clock n	LVDS	PIN_H16

Table 2-14 DDR4-C Pin Assignments, Schematic Signal Names, and Functions

Schematic Signal Name	Description	I/O Standard	Stratix 10 GX/SX Pin Number
DDR4C_DQ0	Data [0]	1.2-V POD	PIN_AP35
DDR4C_DQ1	Data [1]	1.2-V POD	PIN_AT38
DDR4C_DQ2	Data [2]	1.2-V POD	PIN_AP36
DDR4C_DQ3	Data [3]	1.2-V POD	PIN_AR33
DDR4C_DQ4	Data [4]	1.2-V POD	PIN_AN33
DDR4C_DQ5	Data [5]	1.2-V POD	PIN_AR37
DDR4C_DQ6	Data [6]	1.2-V POD	PIN_AR36
DDR4C_DQ7	Data [7]	1.2-V POD	PIN_AR34
DDR4C_DQ8	Data [8]	1.2-V POD	PIN_AU38

DDR4C_DQ9	Data [9]	1.2-V POD	PIN_AV40
DDR4C_DQ10	Data [10]	1.2-V POD	PIN_AW40
DDR4C_DQ11	Data [11]	1.2-V POD	PIN_AV37
DDR4C_DQ12	Data [12]	1.2-V POD	PIN_AU37
DDR4C_DQ13	Data [13]	1.2-V POD	PIN_AW39
DDR4C_DQ14	Data [14]	1.2-V POD	PIN_AV38
DDR4C_DQ15	Data [15]	1.2-V POD	PIN_BA37
DDR4C_DQ16	Data [16]	1.2-V POD	PIN_BD40
DDR4C_DQ17	Data [17]	1.2-V POD	PIN_BF39
DDR4C_DQ18	Data [18]	1.2-V POD	PIN_BG38
DDR4C_DQ19	Data [19]	1.2-V POD	PIN_BH36
DDR4C_DQ20	Data [20]	1.2-V POD	PIN_BE38
DDR4C_DQ21	Data [21]	1.2-V POD	PIN_BE39
DDR4C_DQ22	Data [22]	1.2-V POD	PIN_BG37
DDR4C_DQ23	Data [23]	1.2-V POD	PIN_BH37
DDR4C_DQ24	Data [24]	1.2-V POD	PIN_BB38
DDR4C_DQ25	Data [25]	1.2-V POD	PIN_BB39
DDR4C_DQ26	Data [26]	1.2-V POD	PIN_BC38
DDR4C_DQ27	Data [27]	1.2-V POD	PIN_BC37
DDR4C_DQ28	Data [28]	1.2-V POD	PIN_BA40
DDR4C_DQ29	Data [29]	1.2-V POD	PIN_AY40
DDR4C_DQ30	Data [30]	1.2-V POD	PIN_BC40
DDR4C_DQ31	Data [31]	1.2-V POD	PIN_BB37
DDR4C_DQ32	Data [32]	1.2-V POD	PIN_BF29
DDR4C_DQ33	Data [33]	1.2-V POD	PIN_BE28
DDR4C_DQ34	Data [34]	1.2-V POD	PIN_BJ28
DDR4C_DQ35	Data [35]	1.2-V POD	PIN_BJ30
DDR4C_DQ36	Data [36]	1.2-V POD	PIN_BE32
DDR4C_DQ37	Data [37]	1.2-V POD	PIN_BG32
DDR4C_DQ38	Data [38]	1.2-V POD	PIN_BH28
DDR4C_DQ39	Data [39]	1.2-V POD	PIN_BJ29
DDR4C_DQ40	Data [40]	1.2-V POD	PIN_BE31
DDR4C_DQ41	Data [41]	1.2-V POD	PIN_BD29
DDR4C_DQ42	Data [42]	1.2-V POD	PIN_BF31

DDR4C_DQ43	Data [43]	1.2-V POD	PIN_BG30
DDR4C_DQ44	Data [44]	1.2-V POD	PIN_BF30
DDR4C_DQ45	Data [45]	1.2-V POD	PIN_BE29
DDR4C_DQ46	Data [46]	1.2-V POD	PIN_BG29
DDR4C_DQ47	Data [47]	1.2-V POD	PIN_BH30
DDR4C_DQ48	Data [48]	1.2-V POD	PIN_BA31
DDR4C_DQ49	Data [49]	1.2-V POD	PIN_BC32
DDR4C_DQ50	Data [50]	1.2-V POD	PIN_BB30
DDR4C_DQ51	Data [51]	1.2-V POD	PIN_AW31
DDR4C_DQ52	Data [52]	1.2-V POD	PIN_BC31
DDR4C_DQ53	Data [53]	1.2-V POD	PIN_AY32
DDR4C_DQ54	Data [54]	1.2-V POD	PIN_BB29
DDR4C_DQ55	Data [55]	1.2-V POD	PIN_BA30
DDR4C_DQ56	Data [56]	1.2-V POD	PIN_AU28
DDR4C_DQ57	Data [57]	1.2-V POD	PIN_AT29
DDR4C_DQ58	Data [58]	1.2-V POD	PIN_AW29
DDR4C_DQ59	Data [59]	1.2-V POD	PIN_AY29
DDR4C_DQ60	Data [60]	1.2-V POD	PIN_AT30
DDR4C_DQ61	Data [61]	1.2-V POD	PIN_AU29
DDR4C_DQ62	Data [62]	1.2-V POD	PIN_AU30
DDR4C_DQ63	Data [63]	1.2-V POD	PIN_BA29
DDR4C_DQ64	Data [64]	1.2-V POD	PIN_BD36
DDR4C_DQ65	Data [65]	1.2-V POD	PIN_BF35
DDR4C_DQ66	Data [66]	1.2-V POD	PIN_BC36
DDR4C_DQ67	Data [67]	1.2-V POD	PIN_BD33
DDR4C_DQ68	Data [68]	1.2-V POD	PIN_BE36
DDR4C_DQ69	Data [69]	1.2-V POD	PIN_BF36
DDR4C_DQ70	Data [70]	1.2-V POD	PIN_BB34
DDR4C_DQ71	Data [71]	1.2-V POD	PIN_BB33
DDR4C_DQS0	Data Strobe p[0]	DIFFERENTIAL 1.2-V POD	PIN_AT37
DDR4C_DQS_n0	Data Strobe n[0]	DIFFERENTIAL 1.2-V POD	PIN_AT36
DDR4C_DQS1	Data Strobe p[1]	DIFFERENTIAL 1.2-V	PIN_AY38

		POD	
DDR4C_DQS_n1	Data Strobe n[1]	DIFFERENTIAL 1.2-V POD	PIN_AY39
DDR4C_DQS2	Data Strobe p[2]	DIFFERENTIAL 1.2-V POD	PIN_BF37
DDR4C_DQS_n2	Data Strobe n[2]	DIFFERENTIAL 1.2-V POD	PIN_BE37
DDR4C_DQS3	Data Strobe p[3]	DIFFERENTIAL 1.2-V POD	PIN_BD39
DDR4C_DQS_n3	Data Strobe n[3]	DIFFERENTIAL 1.2-V POD	PIN_BD38
DDR4C_DQS4	Data Strobe p[3]	DIFFERENTIAL 1.2-V POD	PIN_BH31
DDR4C_DQS_n4	Data Strobe n[4]	DIFFERENTIAL 1.2-V POD	PIN_BJ31
DDR4C_DQS5	Data Strobe p[5]	DIFFERENTIAL 1.2-V POD	PIN_BC30
DDR4C_DQS_n5	Data Strobe n[5]	DIFFERENTIAL 1.2-V POD	PIN_BD30
DDR4C_DQS6	Data Strobe p[6]	DIFFERENTIAL 1.2-V POD	PIN_BA32
DDR4C_DQS_n6	Data Strobe n[6]	DIFFERENTIAL 1.2-V POD	PIN_BB32
DDR4C_DQS7	Data Strobe p[7]	DIFFERENTIAL 1.2-V POD	PIN_AW28
DDR4C_DQS_n7	Data Strobe n[7]	DIFFERENTIAL 1.2-V POD	PIN_AV28
DDR4C_DQS8	Data Strobe p[8]	DIFFERENTIAL 1.2-V POD	PIN_BD34
DDR4C_DQS_n8	Data Strobe n[8]	DIFFERENTIAL 1.2-V POD	PIN_BD35
DDR4C_DBI_n0	Data Bus Inversion [0]	1.2-V POD	PIN_AP33
DDR4C_DBI_n1	Data Bus Inversion [1]	1.2-V POD	PIN_AY37

DDR4C_DBI_n2	Data Bus Inversion [2]	1.2-V POD	PIN_BE40
DDR4C_DBI_n3	Data Bus Inversion [3]	1.2-V POD	PIN_BB40
DDR4C_DBI_n4	Data Bus Inversion [4]	1.2-V POD	PIN_BF32
DDR4C_DBI_n5	Data Bus Inversion [5]	1.2-V POD	PIN_BD31
DDR4C_DBI_n6	Data Bus Inversion [6]	1.2-V POD	PIN_AW30
DDR4C_DBI_n7	Data Bus Inversion [7]	1.2-V POD	PIN_AV30
DDR4C_DBI_n8	Data Bus Inversion [8]	1.2-V POD	PIN_BC35
DDR4C_A0	Address [0]	SSTL-12	PIN_AY34
DDR4C_A1	Address [1]	SSTL-12	PIN_BA34
DDR4C_A2	Address [2]	SSTL-12	PIN_BA36
DDR4C_A3	Address [3]	SSTL-12	PIN_AY36
DDR4C_A4	Address [4]	SSTL-12	PIN_AW34
DDR4C_A5	Address [5]	SSTL-12	PIN_AW35
DDR4C_A6	Address [6]	SSTL-12	PIN_BB35
DDR4C_A7	Address [7]	SSTL-12	PIN_BA35
DDR4C_A8	Address [8]	SSTL-12	PIN_AW33
DDR4C_A9	Address [9]	SSTL-12	PIN_AY33
DDR4C_A10	Address [10]	SSTL-12	PIN_AW36
DDR4C_A11	Address [11]	SSTL-12	PIN_AV36
DDR4C_A12	Address [12]	SSTL-12	PIN_BJ36
DDR4C_A13	Address [13]	SSTL-12	PIN_BE33
DDR4C_A14	Address [14]/ WE_n	SSTL-12	PIN_BE34
DDR4C_A15	Address [15]/ CAS_n	SSTL-12	PIN_BH35
DDR4C_A16	Address [16]/ RAS_n	SSTL-12	PIN_BG35

DDR4C_BA0	Bank Select [0]	SSTL-12	PIN_BJ34
DDR4C_BA1	Bank Select [1]	SSTL-12	PIN_BG34
DDR4C_BG0	Bank Group Select [0]	SSTL-12	PIN_BF34
DDR4C_BG1	Bank Group Select [1]	SSTL-12	PIN_AU34
DDR4C_C0	Chip ID 0	SSTL-12	PIN_AR31
DDR4C_C1	Chip ID 1	SSTL-12	PIN_AT34
DDR4C_CK	Clock p	DIFFERENTIAL 1.2-V SSTL	PIN_AV33
DDR4C_CK_n	Clock n	DIFFERENTIAL 1.2-V SSTL	PIN_AV32
DDR4C_CKE	Clock Enable pin	SSTL-12	PIN_AT35
DDR4C_ODT	On Die Termination	SSTL-12	PIN_AR32
DDR4C_CS_n	Chip Select	SSTL-12	PIN_AV35
DDR4C_PAR	Command and Address Parity Input	SSTL-12	PIN_AT32
DDR4C_ALERT_n	Register ALERT_n output	1.2 V	PIN_AP34
DDR4C_ACT_n	Activation Command Input	SSTL-12	PIN_AU35
DDR4C_RESET_n	Chip Reset	1.2 V	PIN_AU33
DDR4C_EVENT_n	Chip Temperature Event	1.2 V	PIN_AY31
DDR4C_SDA	Chip I2C Serial Data Bus	1.2 V	PIN_BH32
DDR4C_SCL	Chip I2C Serial Clock	1.2 V	PIN_BB28
DDR4C_REFCLK_p	DDR4 C port Reference Clock p	LVDS	PIN_BH33
DDR4C_REFCLK_n	DDR4 C port Reference Clock n	LVDS	PIN_BG33

Table 2-15 DDR4-D Pin Assignments, Schematic Signal Names, and Functions

Schematic Signal Name	Description	I/O Standard	Stratix 10 GX/SX Pin Number
DDR4D_DQ0	Data [0]	1.2-V POD	PIN_BF17
DDR4D_DQ1	Data [1]	1.2-V POD	PIN_BG19
DDR4D_DQ2	Data [2]	1.2-V POD	PIN_BH20
DDR4D_DQ3	Data [3]	1.2-V POD	PIN_BG17
DDR4D_DQ4	Data [4]	1.2-V POD	PIN_BG18
DDR4D_DQ5	Data [5]	1.2-V POD	PIN_BH21
DDR4D_DQ6	Data [6]	1.2-V POD	PIN_BG17
DDR4D_DQ7	Data [7]	1.2-V POD	PIN_BJ18
DDR4D_DQ8	Data [8]	1.2-V POD	PIN_BD20
DDR4D_DQ9	Data [9]	1.2-V POD	PIN_BB18
DDR4D_DQ10	Data [10]	1.2-V POD	PIN_BD19
DDR4D_DQ11	Data [11]	1.2-V POD	PIN_BE18
DDR4D_DQ12	Data [12]	1.2-V POD	PIN_BE21
DDR4D_DQ13	Data [13]	1.2-V POD	PIN_BC18
DDR4D_DQ14	Data [14]	1.2-V POD	PIN_BD18
DDR4D_DQ15	Data [15]	1.2-V POD	PIN_BG20
DDR4D_DQ16	Data [16]	1.2-V POD	PIN_AT19
DDR4D_DQ17	Data [17]	1.2-V POD	PIN_AR21
DDR4D_DQ18	Data [18]	1.2-V POD	PIN_AU20
DDR4D_DQ19	Data [19]	1.2-V POD	PIN_AV20
DDR4D_DQ20	Data [20]	1.2-V POD	PIN_AR19
DDR4D_DQ21	Data [21]	1.2-V POD	PIN_AT21
DDR4D_DQ22	Data [22]	1.2-V POD	PIN_AT20
DDR4D_DQ23	Data [23]	1.2-V POD	PIN_AP20
DDR4D_DQ24	Data [24]	1.2-V POD	PIN_BC20
DDR4D_DQ25	Data [25]	1.2-V POD	PIN_BD21
DDR4D_DQ26	Data [26]	1.2-V POD	PIN_BA21
DDR4D_DQ27	Data [27]	1.2-V POD	PIN_BA19
DDR4D_DQ28	Data [28]	1.2-V POD	PIN_AW19
DDR4D_DQ29	Data [29]	1.2-V POD	PIN_AW20

DDR4D_DQ30	Data [30]	1.2-V POD	PIN_BA20
DDR4D_DQ31	Data [31]	1.2-V POD	PIN_BB19
DDR4D_DQ32	Data [32]	1.2-V POD	PIN_AY16
DDR4D_DQ33	Data [33]	1.2-V POD	PIN_AV17
DDR4D_DQ34	Data [34]	1.2-V POD	PIN_BB17
DDR4D_DQ35	Data [35]	1.2-V POD	PIN_AY17
DDR4D_DQ36	Data [36]	1.2-V POD	PIN_AV16
DDR4D_DQ37	Data [37]	1.2-V POD	PIN_AW16
DDR4D_DQ38	Data [38]	1.2-V POD	PIN_BC17
DDR4D_DQ39	Data [39]	1.2-V POD	PIN_BA17
DDR4D_DQ40	Data [40]	1.2-V POD	PIN_BC15
DDR4D_DQ41	Data [41]	1.2-V POD	PIN_BA16
DDR4D_DQ42	Data [42]	1.2-V POD	PIN_AV15
DDR4D_DQ43	Data [43]	1.2-V POD	PIN_BC13
DDR4D_DQ44	Data [44]	1.2-V POD	PIN_AW14
DDR4D_DQ45	Data [45]	1.2-V POD	PIN_BA15
DDR4D_DQ46	Data [46]	1.2-V POD	PIN_AW15
DDR4D_DQ47	Data [47]	1.2-V POD	PIN_BB13
DDR4D_DQ48	Data [48]	1.2-V POD	PIN_BJ16
DDR4D_DQ49	Data [49]	1.2-V POD	PIN_BH12
DDR4D_DQ50	Data [50]	1.2-V POD	PIN_BJ14
DDR4D_DQ51	Data [51]	1.2-V POD	PIN_BF12
DDR4D_DQ52	Data [52]	1.2-V POD	PIN_BG13
DDR4D_DQ53	Data [53]	1.2-V POD	PIN_BH16
DDR4D_DQ54	Data [54]	1.2-V POD	PIN_BJ13
DDR4D_DQ55	Data [55]	1.2-V POD	PIN_BG12
DDR4D_DQ56	Data [56]	1.2-V POD	PIN_BF14
DDR4D_DQ57	Data [57]	1.2-V POD	PIN_BD15
DDR4D_DQ58	Data [58]	1.2-V POD	PIN_BD16
DDR4D_DQ59	Data [59]	1.2-V POD	PIN_BC16
DDR4D_DQ60	Data [60]	1.2-V POD	PIN_BD14
DDR4D_DQ61	Data [61]	1.2-V POD	PIN_BF15
DDR4D_DQ62	Data [62]	1.2-V POD	PIN_BE13
DDR4D_DQ63	Data [63]	1.2-V POD	PIN_BG15

DDR4D_DQ64	Data [64]	1.2-V POD	PIN_AT12
DDR4D_DQ65	Data [65]	1.2-V POD	PIN_AP15
DDR4D_DQ66	Data [66]	1.2-V POD	PIN_AT14
DDR4D_DQ67	Data [67]	1.2-V POD	PIN_AR14
DDR4D_DQ68	Data [68]	1.2-V POD	PIN_AP13
DDR4D_DQ69	Data [69]	1.2-V POD	PIN_AP16
DDR4D_DQ70	Data [70]	1.2-V POD	PIN_AU12
DDR4D_DQ71	Data [71]	1.2-V POD	PIN_AV13
DDR4D_DQS0	Data Strobe p[0]	DIFFERENTIAL 1.2-V POD	PIN_BJ19
DDR4D_DQS_n0	Data Strobe n[0]	DIFFERENTIAL 1.2-V POD	PIN_BJ20
DDR4D_DQS1	Data Strobe p[1]	DIFFERENTIAL 1.2-V POD	PIN_BE19
DDR4D_DQS_n1	Data Strobe n[1]	DIFFERENTIAL 1.2-V POD	PIN_BF19
DDR4D_DQS2	Data Strobe p[2]	DIFFERENTIAL 1.2-V POD	PIN_AN21
DDR4D_DQS_n2	Data Strobe n[2]	DIFFERENTIAL 1.2-V POD	PIN_AP21
DDR4D_DQS3	Data Strobe p[3]	DIFFERENTIAL 1.2-V POD	PIN_AW21
DDR4D_DQS_n3	Data Strobe n[3]	DIFFERENTIAL 1.2-V POD	PIN_AY21
DDR4D_DQS4	Data Strobe p[4]	DIFFERENTIAL 1.2-V POD	PIN_AW18
DDR4D_DQS_n4	Data Strobe n[4]	DIFFERENTIAL 1.2-V POD	PIN_AV18
DDR4D_DQS5	Data Strobe p[5]	DIFFERENTIAL 1.2-V POD	PIN_BA14
DDR4D_DQS_n5	Data Strobe n[5]	DIFFERENTIAL 1.2-V POD	PIN_BB14
DDR4D_DQS6	Data Strobe p[6]	DIFFERENTIAL 1.2-V POD	PIN_BJ15
DDR4D_DQS_n6	Data Strobe n[6]	DIFFERENTIAL 1.2-V	PIN_BH15

		POD	
DDR4D_DQS7	Data Strobe p[7]	DIFFERENTIAL 1.2-V POD	PIN_BF16
DDR4D_DQS_n7	Data Strobe n[7]	DIFFERENTIAL 1.2-V POD	PIN_BE16
DDR4D_DQS8	Data Strobe p[8]	DIFFERENTIAL 1.2-V POD	PIN_AP12
DDR4D_DQS_n8	Data Strobe n[8]	DIFFERENTIAL 1.2-V POD	PIN_AR13
DDR4D_DBI_n0	Data Bus Inversion [0]	1.2-V POD	PIN_BE17
DDR4D_DBI_n1	Data Bus Inversion [1]	1.2-V POD	PIN_BF20
DDR4D_DBI_n2	Data Bus Inversion [2]	1.2-V POD	PIN_AN20
DDR4D_DBI_n3	Data Bus Inversion [3]	1.2-V POD	PIN_BC21
DDR4D_DBI_n4	Data Bus Inversion [4]	1.2-V POD	PIN_AY18
DDR4D_DBI_n5	Data Bus Inversion [5]	1.2-V POD	PIN_AY14
DDR4D_DBI_n6	Data Bus Inversion [6]	1.2-V POD	PIN_BG14
DDR4D_DBI_n7	Data Bus Inversion [7]	1.2-V POD	PIN_BD13
DDR4D_DBI_n8	Data Bus Inversion [8]	1.2-V POD	PIN_AU13
DDR4D_A0	Address [0]	SSTL-12	PIN_AY11
DDR4D_A1	Address [1]	SSTL-12	PIN_AW11
DDR4D_A2	Address [2]	SSTL-12	PIN_BA10
DDR4D_A3	Address [3]	SSTL-12	PIN_BA11
DDR4D_A4	Address [4]	SSTL-12	PIN_BA12
DDR4D_A5	Address [5]	SSTL-12	PIN_AY12
DDR4D_A6	Address [6]	SSTL-12	PIN_AV11
DDR4D_A7	Address [7]	SSTL-12	PIN_AV12

DDR4D_A8	Address [8]	SSTL-12	PIN_AW13
DDR4D_A9	Address [9]	SSTL-12	PIN_AY13
DDR4D_A10	Address [10]	SSTL-12	PIN_AW10
DDR4D_A11	Address [11]	SSTL-12	PIN_AV10
DDR4D_A12	Address [12]	SSTL-12	PIN_AN18
DDR4D_A13	Address [13]	SSTL-12	PIN_AR17
DDR4D_A14	Address [14]/ WE_n	SSTL-12	PIN_AR16
DDR4D_A15	Address [15]/ CAS_n	SSTL-12	PIN_AT15
DDR4D_A16	Address [16]/ RAS_n	SSTL-12	PIN_AT16
DDR4D_BA0	Bank Select [0]	SSTL-12	PIN_AU14
DDR4D_BA1	Bank Select [1]	SSTL-12	PIN_AP18
DDR4D_BG0	Bank Group Select [0]	SSTL-12	PIN_AR18
DDR4D_BG1	Bank Group Select [1]	SSTL-12	PIN_BF11
DDR4D_C0	Chip ID 0	SSTL-12	PIN_BE11
DDR4D_C1	Chip ID 1	SSTL-12	PIN_BB10
DDR4D_CK	Clock p	DIFFERENTIAL 1.2-V SSTL	PIN_BC12
DDR4D_CK_n	Clock n	DIFFERENTIAL 1.2-V SSTL	PIN_BB12
DDR4D_CKE	Clock Enable pin	SSTL-12	PIN_BC10
DDR4D_ODT	On Die Termination	SSTL-12	PIN_BE12
DDR4D_CS_n	Chip Select	SSTL-12	PIN_BE10
DDR4D_PAR	Command and Address Parity Input	SSTL-12	PIN_BC11
DDR4D_ALERT_n	Register ALERT_n output	1.2 V	PIN_BH18
DDR4D_ACT_n	Activation Command Input	SSTL-12	PIN_BD10

DDR4D_RESET_n	Chip Reset	1.2 V	PIN_BF10
DDR4D_EVENT_n	Chip Temperature Event	1.2 V	PIN_BH13
DDR4D_SDA	Chip I2C Serial Data Bus	1.2 V	PIN_AY19
DDR4D_SCL	Chip I2C Serial Clock	1.2 V	PIN_BE14
DDR4D_REFCLK_p	DDR4 D port Reference Clock p	LVDS	PIN_AT17
DDR4D_REFCLK_n	DDR4 D port Reference Clock n	LVDS	PIN_AU17

2.9 QSPF28 Ports

The development board has four independent 100G QSFP28 connectors that use one transceiver channel each from the Stratix 10 GX/SX FPGA device. These modules take in serial data from the Stratix 10 GX/SX FPGA device and transform them to optical signals. The board includes cage assemblies for the QSFP+ connectors. **Figure 2-15** shows the connections between the QSFP28 and Stratix 10 GX/SX FPGA.

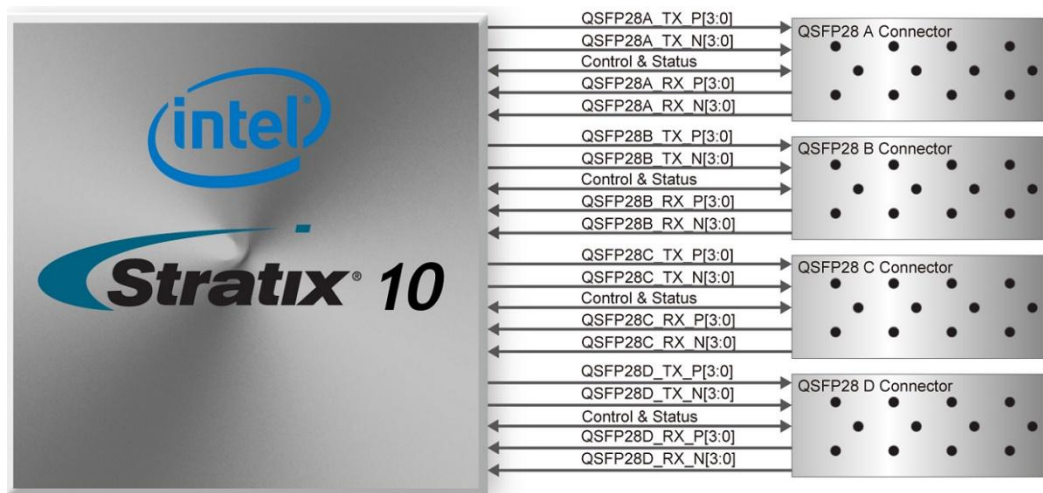

Figure 2-15 Connection between the QSFP28 and Stratix 10 GX/SX FPGA

Table 2-16, **Table 2-17**, **Table 2-18** and **Table 2-19** list the QSFP28 A, B, C and D pin assignments and signal names relative to the Stratix 10 GX/SX device.

Table 2-16 QSFP28 A Pin Assignments, Schematic Signal Names, and Functions

Schematic Signal Name	Description	I/O Standard	Stratix 10 GX/SX Pin Number
QSFP28A_TX_P0	Transmitter data of channel 0	HSSI DIFFERENTIAL I/O	PIN_F49
QSFP28A_TX_N0	Transmitter data of channel 0	HSSI DIFFERENTIAL I/O	PIN_F48
QSFP28A_RX_P0	Receiver data of channel 0	HSSI DIFFERENTIAL I/O	PIN_G43
QSFP28A_RX_N0	Receiver data of channel 0	HSSI DIFFERENTIAL I/O	PIN_G42
QSFP28A_TX_P1	Transmitter data of channel 1	HSSI DIFFERENTIAL I/O	PIN_G47
QSFP28A_TX_N1	Transmitter data of channel 1	HSSI DIFFERENTIAL I/O	PIN_G46
QSFP28A_RX_P1	Receiver data of channel 1	HSSI DIFFERENTIAL I/O	PIN_D45
QSFP28A_RX_N1	Receiver data of channel 1	HSSI DIFFERENTIAL I/O	PIN_D44
QSFP28A_TX_P2	Transmitter data of channel 2	HSSI DIFFERENTIAL I/O	PIN_E47
QSFP28A_TX_N2	Transmitter data of channel 2	HSSI DIFFERENTIAL I/O	PIN_E46

QSFP28A_RX_P2	Receiver data of channel 2	HSSI DIFFERENTIAL I/O	PIN_C43
QSFP28A_RX_N2	Receiver data of channel 2	HSSI DIFFERENTIAL I/O	PIN_C42
QSFP28A_TX_P3	Transmitter data of channel 3	HSSI DIFFERENTIAL I/O	PIN_C47
QSFP28A_TX_N3	Transmitter data of channel 3	HSSI DIFFERENTIAL I/O	PIN_C46
QSFP28A_RX_P3	Receiver data of channel 3	HSSI DIFFERENTIAL I/O	PIN_A43
QSFP28A_RX_N3	Receiver data of channel 3	HSSI DIFFERENTIAL I/O	PIN_A42
QSFP28A_REFCLK_p	QSFP28A transceiver reference clock p	LVDS	PIN_T41
QSFP28A_REFCLK_n	QSFP28A transceiver reference clock n	LVDS	PIN_T40
QSFP28A_MOD_SEL_n	Module Select	3.0-V LVTTTL	PIN_AD35
QSFP28A_RST_n	Module Reset	3.0-V LVTTTL	PIN_AC33
QSFP28A_SCL	2-wire serial interface clock	3.0-V LVTTTL	PIN_AC36
QSFP28A_SDA	2-wire serial interface data	3.0-V LVTTTL	PIN_AC35
QSFP28A_LP_MODE	Low Power Mode	3.0-V LVTTTL	PIN_AB36
QSFP28A_INTERRUPT_n	Interrupt	3.0-V LVTTTL	PIN_AB35
QSFP28A_MOD_PRS_n	Module Present	3.0-V LVTTTL	PIN_AB34

Table 2-17 QSFP28 B Pin Assignments, Schematic Signal Names, and Functions

Schematic Signal Name	Description	I/O Standard	Stratix 10 GX/SX Pin
--------------------------	-------------	--------------	-------------------------

			Number
QSFP28B_TX_P0	Transmitter data of channel 0	HSSI DIFFERENTIAL I/O	PIN_AK49
QSFP28B_TX_N0	Transmitter data of channel 0	HSSI DIFFERENTIAL I/O	PIN_AK48
QSFP28B_RX_P0	Receiver data of channel 0	HSSI DIFFERENTIAL I/O	PIN_AL43
QSFP28B_RX_N0	Receiver data of channel 0	HSSI DIFFERENTIAL I/O	PIN_AL42
QSFP28B_TX_P1	Transmitter data of channel 1	HSSI DIFFERENTIAL I/O	PIN_AL47
QSFP28B_TX_N1	Transmitter data of channel 1	HSSI DIFFERENTIAL I/O	PIN_AL46
QSFP28B_RX_P1	Receiver data of channel 1	HSSI DIFFERENTIAL I/O	PIN_AH45
QSFP28B_RX_N1	Receiver data of channel 1	HSSI DIFFERENTIAL I/O	PIN_AH44
QSFP28B_TX_P2	Transmitter data of channel 2	HSSI DIFFERENTIAL I/O	PIN_AJ47
QSFP28B_TX_N2	Transmitter data of channel 2	HSSI DIFFERENTIAL I/O	PIN_AJ46
QSFP28B_RX_P2	Receiver data of channel 2	HSSI DIFFERENTIAL I/O	PIN_AF45
QSFP28B_RX_N2	Receiver data of channel 2	HSSI	PIN_AF44

		DIFFERENTIAL I/O	
QSFP28B_TX_P3	Transmitter data of channel 3	HSSI DIFFERENTIAL I/O	PIN_AF49
QSFP28B_TX_N3	Transmitter data of channel 3	HSSI DIFFERENTIAL I/O	PIN_AF48
QSFP28B_RX_P3	Receiver data of channel 3	HSSI DIFFERENTIAL I/O	PIN_AG43
QSFP28B_RX_N3	Receiver data of channel 3	HSSI DIFFERENTIAL I/O	PIN_AG42
QSFP28B_REFCLK_p	QSFP28B transceiver reference clock p	LVDS	PIN_AM38
QSFP28B_REFCLK_n	QSFP28B transceiver reference clock n	LVDS	PIN_AM37
QSFP28B_MOD_SEL_n	Module Select	3.0-V LVTTTL	PIN_AJ33
QSFP28B_RST_n	Module Reset	3.0-V LVTTTL	PIN_AG34
QSFP28B_SCL	2-wire serial interface clock	3.0-V LVTTTL	PIN_AH32
QSFP28B_SDA	2-wire serial interface data	3.0-V LVTTTL	PIN_AE36
QSFP28B_LP_MODE	Low Power Mode	3.0-V LVTTTL	PIN_AF34
QSFP28B_INTERRUPT_n	Interrupt	3.0-V LVTTTL	PIN_AF17
QSFP28B_MOD_PRS_n	Module Present	3.0-V LVTTTL	PIN_AH17

Table 2-18 QSFP28 C Pin Assignments, Schematic Signal Names, and Functions

Schematic Signal Name	Description	I/O Standard	Stratix 10 GX/SX Pin Number
QSFP28C_TX_P0	Transmitter data of channel 0	HSSI DIFFERENTIAL I/O	PIN_AK1
QSFP28C_TX_N0	Transmitter data of channel 0	HSSI DIFFERENTIAL	PIN_AK2

		I/O	
QSFP28C_RX_P0	Receiver data of channel 0	HSSI DIFFERENTIAL I/O	PIN_AL7
QSFP28C_RX_N0	Receiver data of channel 0	HSSI DIFFERENTIAL I/O	PIN_AL8
QSFP28C_TX_P1	Transmitter data of channel 1	HSSI DIFFERENTIAL I/O	PIN_AL3
QSFP28C_TX_N1	Transmitter data of channel 1	HSSI DIFFERENTIAL I/O	PIN_AL4
QSFP28C_RX_P1	Receiver data of channel 1	HSSI DIFFERENTIAL I/O	PIN_AH5
QSFP28C_RX_N1	Receiver data of channel 1	HSSI DIFFERENTIAL I/O	PIN_AH6
QSFP28C_TX_P2	Transmitter data of channel 2	HSSI DIFFERENTIAL I/O	PIN_AJ3
QSFP28C_TX_N2	Transmitter data of channel 2	HSSI DIFFERENTIAL I/O	PIN_AJ4
QSFP28C_RX_P2	Receiver data of channel 2	HSSI DIFFERENTIAL I/O	PIN_AF5
QSFP28C_RX_N2	Receiver data of channel 2	HSSI DIFFERENTIAL I/O	PIN_AF6
QSFP28C_TX_P3	Transmitter data of channel 3	HSSI DIFFERENTIAL I/O	PIN_AF1
QSFP28C_TX_N3	Transmitter data of channel 3	HSSI	PIN_AF2

		DIFFERENTIAL I/O	
QSFP28C_RX_P3	Receiver data of channel 3	HSSI DIFFERENTIAL I/O	PIN_AG7
QSFP28C_RX_N3	Receiver data of channel 3	HSSI DIFFERENTIAL I/O	PIN_AG8
QSFP28C_REFCLK_p	QSFP28C transceiver reference clock p	LVDS	PIN_AM12
QSFP28C_REFCLK_n	QSFP28C transceiver reference clock n	LVDS	PIN_AM13
QSFP28C_MOD_SEL_n	Module Select	3.0-V LVTTTL	PIN_AE14
QSFP28C_RST_n	Module Reset	3.0-V LVTTTL	PIN_AD15
QSFP28C_SCL	2-wire serial interface clock	3.0-V LVTTTL	PIN_AD16
QSFP28C_SDA	2-wire serial interface data	3.0-V LVTTTL	PIN_AF15
QSFP28C_LP_MODE	Low Power Mode	3.0-V LVTTTL	PIN_AE16
QSFP28C_INTERRUPT_n	Interrupt	3.0-V LVTTTL	PIN_AF16
QSFP28C_MOD_PRS_n	Module Present	3.0-V LVTTTL	PIN_AH16

Table 2-19 QSFP+ D Pin Assignments, Schematic Signal Names, and Functions

Schematic Signal Name	Description	I/O Standard	Stratix 10 GX/SX Pin Number
QSFP28D_TX_P0	Transmitter data of channel 0	HSSI DIFFERENTIAL I/O	PIN_F1
QSFP28D_TX_N0	Transmitter data of channel 0	HSSI DIFFERENTIAL I/O	PIN_F2
QSFP28D_RX_P0	Receiver data of channel 0	HSSI DIFFERENTIAL I/O	PIN_G7
QSFP28D_RX_N0	Receiver data of channel 0	HSSI	PIN_G8

		DIFFERENTIAL I/O	
QSFP28D_TX_P1	Transmitter data of channel 1	HSSI DIFFERENTIAL I/O	PIN_G3
QSFP28D_TX_N1	Transmitter data of channel 1	HSSI DIFFERENTIAL I/O	PIN_G4
QSFP28D_RX_P1	Receiver data of channel 1	HSSI DIFFERENTIAL I/O	PIN_D5
QSFP28D_RX_N1	Receiver data of channel 1	HSSI DIFFERENTIAL I/O	PIN_D6
QSFP28D_TX_P2	Transmitter data of channel 2	HSSI DIFFERENTIAL I/O	PIN_E3
QSFP28D_TX_N2	Transmitter data of channel 2	HSSI DIFFERENTIAL I/O	PIN_E4
QSFP28D_RX_P2	Receiver data of channel 2	HSSI DIFFERENTIAL I/O	PIN_C7
QSFP28D_RX_N2	Receiver data of channel 2	HSSI DIFFERENTIAL I/O	PIN_C8
QSFP28D_TX_P3	Transmitter data of channel 3	HSSI DIFFERENTIAL I/O	PIN_C3
QSFP28D_TX_N3	Transmitter data of channel 3	HSSI DIFFERENTIAL I/O	PIN_C4
QSFP28D_RX_P3	Receiver data of channel 3	HSSI DIFFERENTIAL I/O	PIN_A7

QSFP28D_RX_N3	Receiver data of channel 3	HSSI DIFFERENTIAL I/O	PIN_A8
QSFP28D_REFCLK_p	QSFP28D transceiver reference clock p	LVDS	PIN_T9
QSFP28D_REFCLK_n	QSFP28D transceiver reference clock n	LVDS	PIN_T10
QSFP28D_MOD_SEL_n	Module Select	3.0-V LVTTTL	PIN_AB12
QSFP28D_RST_n	Module Reset	3.0-V LVTTTL	PIN_AB13
QSFP28D_SCL	2-wire serial interface clock	3.0-V LVTTTL	PIN_AB14
QSFP28D_SDA	2-wire serial interface data	3.0-V LVTTTL	PIN_AC14
QSFP28D_LP_MODE	Low Power Mode	3.0-V LVTTTL	PIN_AB15
QSFP28D_INTERRUPT_n	Interrupt	3.0-V LVTTTL	PIN_AD14
QSFP28D_MOD_PRS_n	Module Present	3.0-V LVTTTL	PIN_AC15

2.10 PCI Express

The FPGA development board is designed to fit entirely into a PC motherboard with x16 PCI Express slot. Utilizing built-in transceivers on a Stratix 10 GX/SX device, it is able to provide a fully integrated PCI Express-compliant solution for multi-lane (x1, x4, x8 and x16) applications. With the PCI Express hard IP block incorporated in the Stratix 10 GX/SX device, it will allow users to implement simple and fast protocol, as well as saving logic resources for logic application. **Figure 2-16** presents the pin connection established between the Stratix 10 GX/SX and PCI Express.

The PCI Express interface supports complete PCI Express Gen1 at 2.5Gbps/lane, Gen2 at 5.0Gbps/lane, and Gen3 at 8.0Gbps/lane protocol stack solution compliant to PCI Express base specification 3.0 that includes PHY-MAC, Data Link, and transaction layer circuitry embedded in PCI Express hard IP blocks.

Please note that it is a requirement that you connect the PCIe external power connector 8-pin 12V DC power connector in the FPGA to avoid FPGA damage due to insufficient power. The PCIE_REFCLK_p signal is a differential input that is driven from the PC motherboard on this board through the PCIe edge connector. A DIP switch (SW6) is connected to the PCI Express to allow different configurations to enable a x1,

x4, x8 or x16 PCIe.

Table 2-20 summarizes the PCI Express pin assignments of the signal names relative to the Stratix 10 GX/SX FPGA.

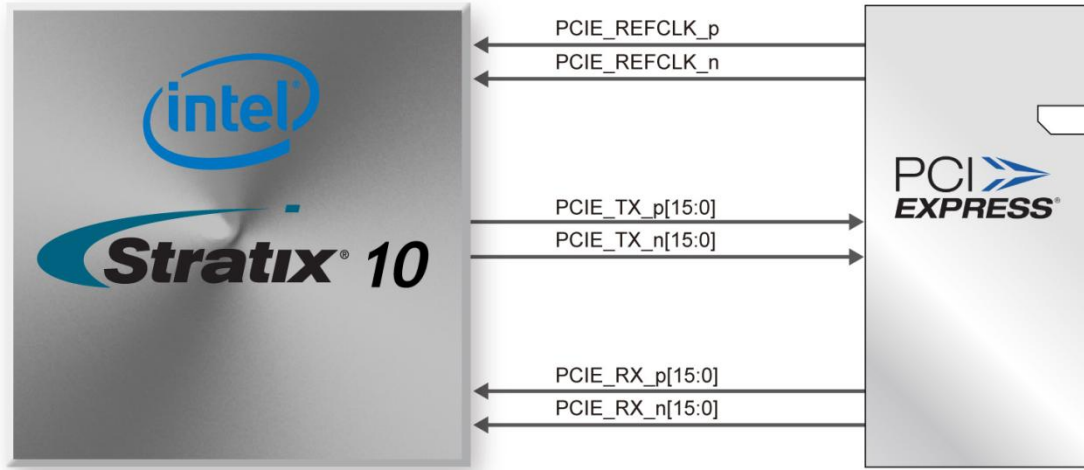

Figure 2-16 PCI Express pin connection

Table 2-20 PCI Express Pin Assignments, Schematic Signal Names, and Functions

Schematic Signal Name	Description	I/O Standard	Stratix 10 GX/SX Pin Number
PCIE_TX_p0	Add-in card transmit bus	HIGH SPEED DIFFERENTIAL I/O	PIN_BJ46
PCIE_TX_n0	Add-in card transmit bus	HIGH SPEED DIFFERENTIAL I/O	PIN_BJ45
PCIE_TX_p1	Add-in card transmit bus	HIGH SPEED DIFFERENTIAL I/O	PIN_BF45
PCIE_TX_n1	Add-in card transmit bus	HIGH SPEED DIFFERENTIAL I/O	PIN_BF44
PCIE_TX_p2	Add-in card transmit bus	HIGH SPEED	PIN_BG47

		DIFFERENTIAL I/O	
PCIE_TX_n2	Add-in card transmit bus	HIGH SPEED DIFFERENTIAL I/O	PIN_BG46
PCIE_TX_p3	Add-in card transmit bus	HIGH SPEED DIFFERENTIAL I/O	PIN_BE47
PCIE_TX_n3	Add-in card transmit bus	HIGH SPEED DIFFERENTIAL I/O	PIN_BE46
PCIE_TX_p4	Add-in card transmit bus	HIGH SPEED DIFFERENTIAL I/O	PIN_BF49
PCIE_TX_n4	Add-in card transmit bus	HIGH SPEED DIFFERENTIAL I/O	PIN_BF48
PCIE_TX_p5	Add-in card transmit bus	HIGH SPEED DIFFERENTIAL I/O	PIN_BC47
PCIE_TX_n5	Add-in card transmit bus	HIGH SPEED DIFFERENTIAL I/O	PIN_BC46
PCIE_TX_p6	Add-in card transmit bus	HIGH SPEED DIFFERENTIAL I/O	PIN_BD49
PCIE_TX_n6	Add-in card transmit bus	HIGH SPEED DIFFERENTIAL I/O	PIN_BD48
PCIE_TX_p7	Add-in card transmit bus	HIGH SPEED DIFFERENTIAL I/O	PIN_BA47
PCIE_TX_n7	Add-in card transmit bus	HIGH SPEED DIFFERENTIAL I/O	PIN_BA46

PCIE_TX_p8	Add-in card transmit bus	HIGH SPEED DIFFERENTIAL I/O	PIN_BB49
PCIE_TX_n8	Add-in card transmit bus	HIGH SPEED DIFFERENTIAL I/O	PIN_BB48
PCIE_TX_p9	Add-in card transmit bus	HIGH SPEED DIFFERENTIAL I/O	PIN_AW47
PCIE_TX_n9	Add-in card transmit bus	HIGH SPEED DIFFERENTIAL I/O	PIN_AW46
PCIE_TX_p10	Add-in card transmit bus	HIGH SPEED DIFFERENTIAL I/O	PIN_AY49
PCIE_TX_n10	Add-in card transmit bus	HIGH SPEED DIFFERENTIAL I/O	PIN_AY48
PCIE_TX_p11	Add-in card transmit bus	HIGH SPEED DIFFERENTIAL I/O	PIN_AU47
PCIE_TX_n11	Add-in card transmit bus	HIGH SPEED DIFFERENTIAL I/O	PIN_AU46
PCIE_TX_p12	Add-in card transmit bus	HIGH SPEED DIFFERENTIAL I/O	PIN_AV49
PCIE_TX_n12	Add-in card transmit bus	HIGH SPEED DIFFERENTIAL I/O	PIN_AV48
PCIE_TX_p13	Add-in card transmit bus	HIGH SPEED DIFFERENTIAL I/O	PIN_AR47
PCIE_TX_n13	Add-in card transmit bus	HIGH SPEED DIFFERENTIAL	PIN_AR46

		I/O	
PCIE_TX_p14	Add-in card transmit bus	HIGH SPEED DIFFERENTIAL I/O	PIN_AT49
PCIE_TX_n14	Add-in card transmit bus	HIGH SPEED DIFFERENTIAL I/O	PIN_AT48
PCIE_TX_p15	Add-in card transmit bus	HIGH SPEED DIFFERENTIAL I/O	PIN_AP49
PCIE_TX_n15	Add-in card transmit bus	HIGH SPEED DIFFERENTIAL I/O	PIN_AP48
PCIE_RX_p0	Add-in card receive bus	CURRENT MODE LOGIC (CML)	PIN_BH41
PCIE_RX_n0	Add-in card receive bus	CURRENT MODE LOGIC (CML)	PIN_BH40
PCIE_RX_p1	Add-in card receive bus	CURRENT MODE LOGIC (CML)	PIN_BJ43
PCIE_RX_n1	Add-in card receive bus	CURRENT MODE LOGIC (CML)	PIN_BJ42
PCIE_RX_p2	Add-in card receive bus	CURRENT MODE LOGIC (CML)	PIN_BG43
PCIE_RX_n2	Add-in card receive bus	CURRENT MODE LOGIC (CML)	PIN_BG42
PCIE_RX_p3	Add-in card receive bus	CURRENT MODE LOGIC (CML)	PIN_BE43
PCIE_RX_n3	Add-in card receive bus	CURRENT	PIN_BE42

		MODE LOGIC (CML)	
PCIE_RX_p4	Add-in card receive bus	CURRENT MODE LOGIC (CML)	PIN_BC43
PCIE_RX_n4	Add-in card receive bus	CURRENT MODE LOGIC (CML)	PIN_BC42
PCIE_RX_p5	Add-in card receive bus	CURRENT MODE LOGIC (CML)	PIN_BD45
PCIE_RX_n5	Add-in card receive bus	CURRENT MODE LOGIC (CML)	PIN_BD44
PCIE_RX_p6	Add-in card receive bus	CURRENT MODE LOGIC (CML)	PIN_BA43
PCIE_RX_n6	Add-in card receive bus	CURRENT MODE LOGIC (CML)	PIN_BA42
PCIE_RX_p7	Add-in card receive bus	CURRENT MODE LOGIC (CML)	PIN_BB45
PCIE_RX_n7	Add-in card receive bus	CURRENT MODE LOGIC (CML)	PIN_BB44
PCIE_RX_p8	Add-in card receive bus	CURRENT MODE LOGIC (CML)	PIN_AW43
PCIE_RX_n8	Add-in card receive bus	CURRENT MODE LOGIC (CML)	PIN_AW42
PCIE_RX_p9	Add-in card receive bus	CURRENT MODE LOGIC (CML)	PIN_AY45

PCIE_RX_n9	Add-in card receive bus	CURRENT MODE LOGIC (CML)	PIN_AY44
PCIE_RX_p10	Add-in card receive bus	CURRENT MODE LOGIC (CML)	PIN_AU43
PCIE_RX_n10	Add-in card receive bus	CURRENT MODE LOGIC (CML)	PIN_AU42
PCIE_RX_p11	Add-in card receive bus	CURRENT MODE LOGIC (CML)	PIN_AV45
PCIE_RX_n11	Add-in card receive bus	CURRENT MODE LOGIC (CML)	PIN_AV44
PCIE_RX_p12	Add-in card receive bus	CURRENT MODE LOGIC (CML)	PIN_AR43
PCIE_RX_n12	Add-in card receive bus	CURRENT MODE LOGIC (CML)	PIN_AR42
PCIE_RX_p13	Add-in card receive bus	CURRENT MODE LOGIC (CML)	PIN_AT45
PCIE_RX_n13	Add-in card receive bus	CURRENT MODE LOGIC (CML)	PIN_AT44
PCIE_RX_p14	Add-in card receive bus	CURRENT MODE LOGIC (CML)	PIN_AP45
PCIE_RX_n14	Add-in card receive bus	CURRENT MODE LOGIC (CML)	PIN_AP44
PCIE_RX_p15	Add-in card receive bus	CURRENT MODE LOGIC	PIN_AN43

		(CML)	
PCIE_RX_n15	Add-in card receive bus	CURRENT MODE LOGIC (CML)	PIN_AN42
PCIE_REFCLK_p	Motherboard reference clock	HCSL	PIN_AM41
PCIE_REFCLK_n	Motherboard reference clock	HCSL	PIN_AM40
PCIE_PERST_n	Reset	3.0-V LVTTTL	PIN_AJ34
PCIE_SMBCLK	SMB clock	1.2-V	PIN_BA39
PCIE_SMBDAT	SMB data	1.2-V	PIN_BF40
PCIE_WAKE_n	Wake signal	1.2-V	PIN_BC33
PCIE_PRSNT1n	Hot plug detect	-	-
PCIE_PRSNT2n_x1	Hot plug detect x1 PCIe slot enabled using SW6 dip switch	-	-
PCIE_PRSNT2n_x4	Hot plug detect x4 PCIe slot enabled using SW6 dip switch	-	-
PCIE_PRSNT2n_x8	Hot plug detect x8 PCIe slot enabled using SW6 dip switch	-	-
PCIE_PRSNT2n_x16	Hot plug detect x16 PCIe slot enabled using SW6 dip switch	-	-

Chapter 3

System Builder

This chapter describes how users can create a custom design project for the FPGA board from a software tool named System Builder.

3.1 Introduction

The System Builder is a Windows based software utility. It is designed to help users create a Quartus Prime project for the FPGA board within minutes. The Quartus Prime project files generated include:

- Quartus Prime Project File (.qpf)
- Quartus Prime Setting File (.qsf)
- Top-Level Design File (.v)
- External PLL Controller (.v)
- Synopsis Design Constraints file (.sdc)
- Pin Assignment Document (.htm)

The System Builder not only can generate the files above, but can also provide error-checking rules to handle situation that are prone to errors. The common mistakes that users encounter are the following:

- Board damaged for wrong pin/bank voltage assignment.
- Board malfunction caused by wrong device connections or missing pin counts for connected ends.
- Performance dropped because of improper pin assignments

3.2 General Design Flow

This section will introduce the general design flow to build a project for the FPGA board via the System Builder. The general design flow is illustrated in **Figure 3-1**.

Users should launch System Builder and create a new project according to their design requirements. When users complete the settings, the System Builder will generate two major files which include top-level design file (.v) and the Quartus Prime setting file (.qsf).

The top-level design file contains top-level Verilog wrapper for users to add their own design/logic. The Quartus Prime setting file contains information such as FPGA device type, top-level pin assignment, and I/O standard for each user-defined I/O pin.

Finally, the Quartus Prime programmer must be used to download SOF file to the FPGA board using JTAG interface.

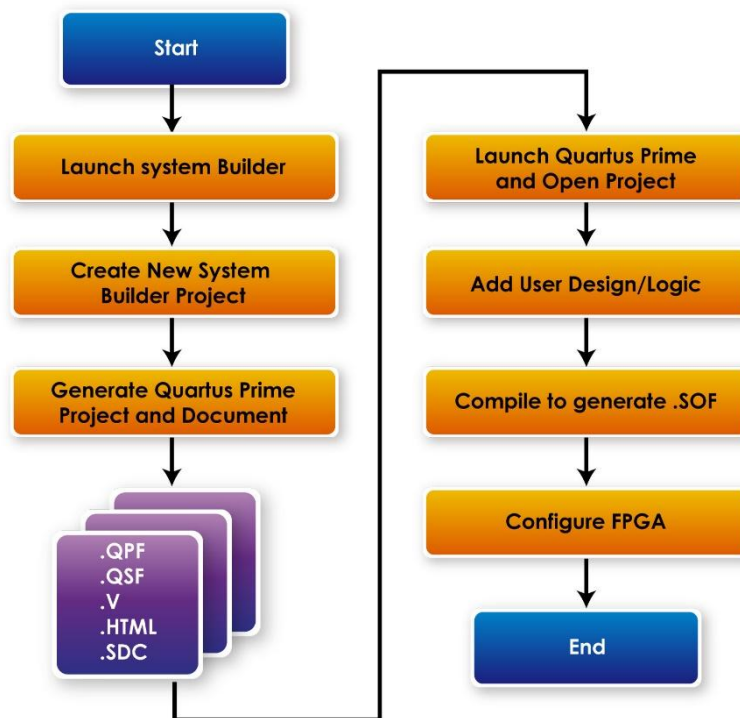

Figure 3-1 the general design flow of building a project

3.3 Using System Builder

This section provides detailed procedures on how the System Builder is used.

■ Install and Launch the System Builder

The System Builder is located under the directory: **"Tools\SystemBuilder"** in the System CD. Users can copy the entire folder to the host computer without installing the utility. Please execute the SystemBuilder.exe on the host computer, as shown in **Figure 3-2**.

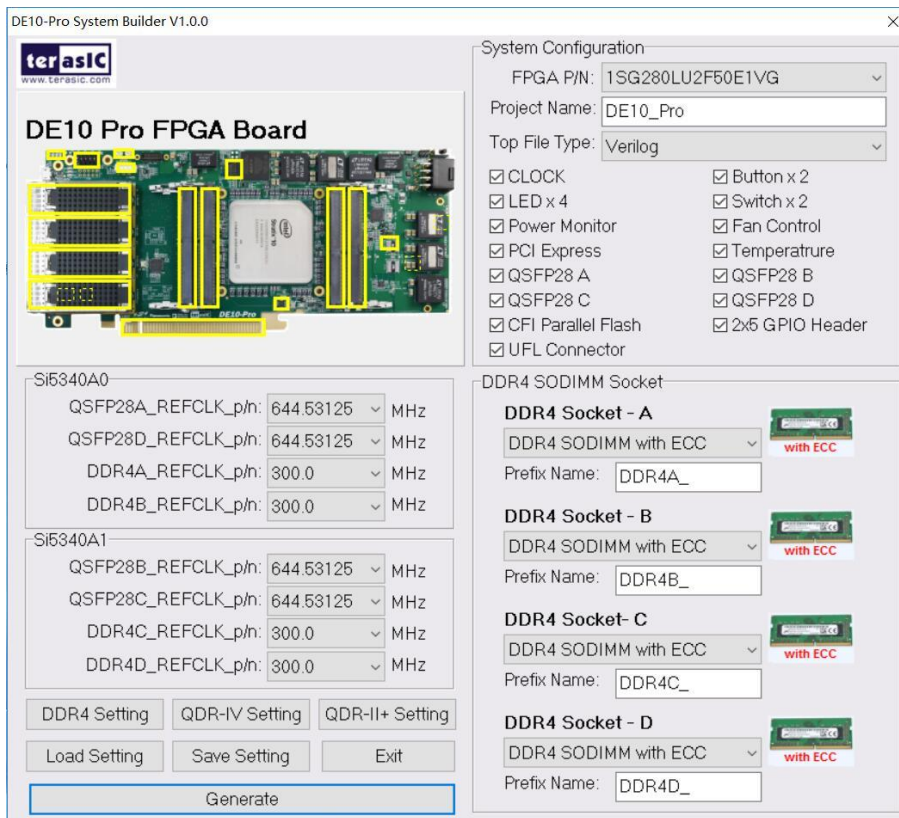

Figure 3-2 The System Builder window

■ Select FPGA

As described in section 1.2, DE10-Pro version B supports three types FPGA, users can select FPGA P/N in System Builder as shown in **Figure 3-3**.

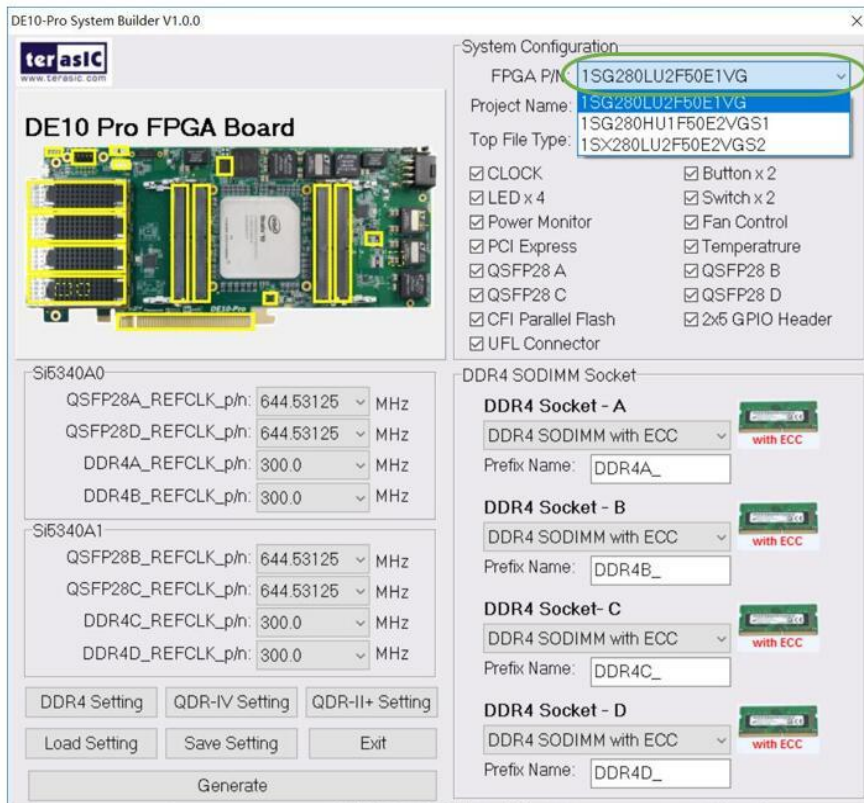

Figure 3-3 Select FPGA

■ Enter Project Name

The project name entered in the circled area as shown in [Figure 3-4](#), will be assigned automatically as the name of the top-level design entry.

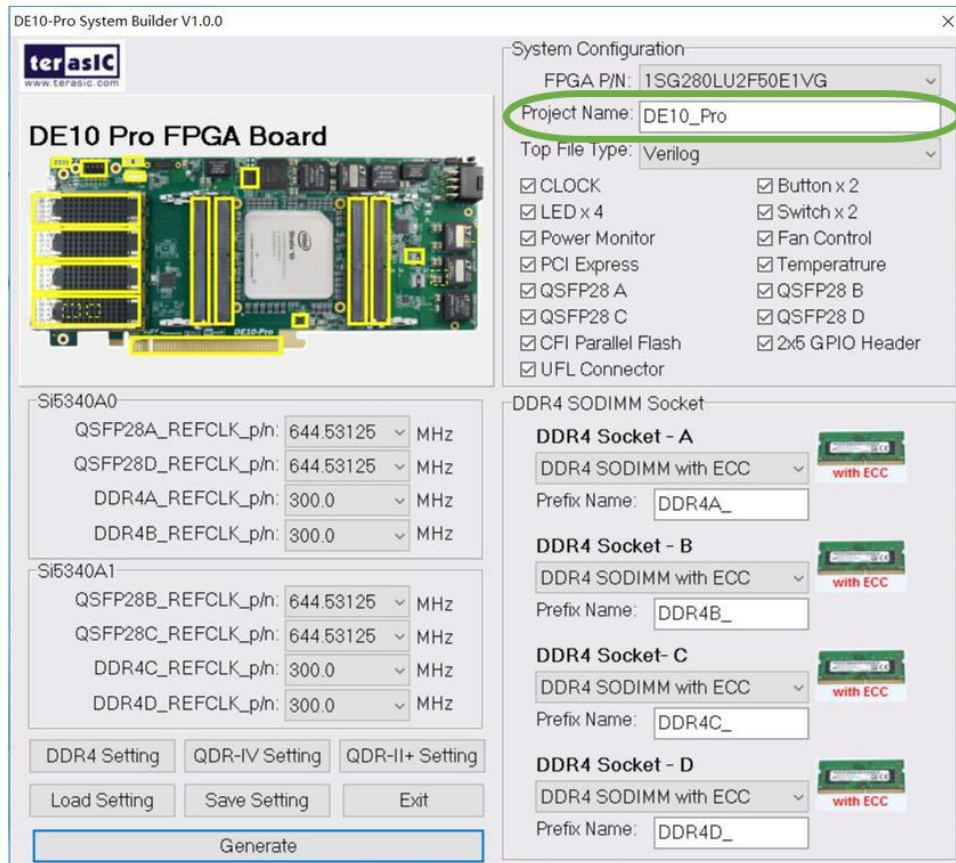

Figure 3-4 Project Name in the System Builder window

■ Select Top File Type

The system builder can generate Verilog or VHDL Quartus top file according to the users' requirements. Users can select their desired file type in the Top File Type list-box shown in [Figure 3-5](#).

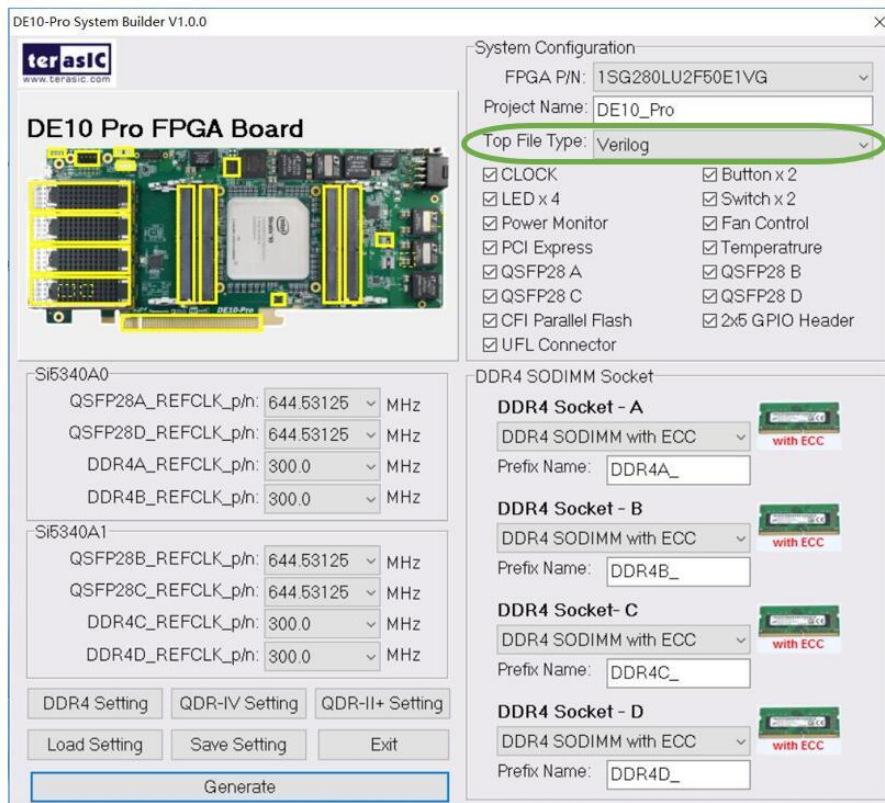

Figure 3-5 Top File Type in the System Builder window

■ System Configuration

Users are given the flexibility of enabling their choices of components connected to the FPGA under System Configuration, as shown in **Figure 3-6**. Each component of the FPGA board is listed to be enabled or disabled according to users' needs. If a component is enabled, the System Builder will automatically generate the associated pin assignments including its pin name, pin location, pin direction, and I/O standards.

Note: The pin assignments for some components (e.g. DDR4 and QSFP28) require associated controller codes in the Quartus project or it would result in compilation error. Hence please do not select them if they are not needed in the design. To use the DDR4 controller, please refer to the DDR4 SDRAM demonstration in Chapter 6.

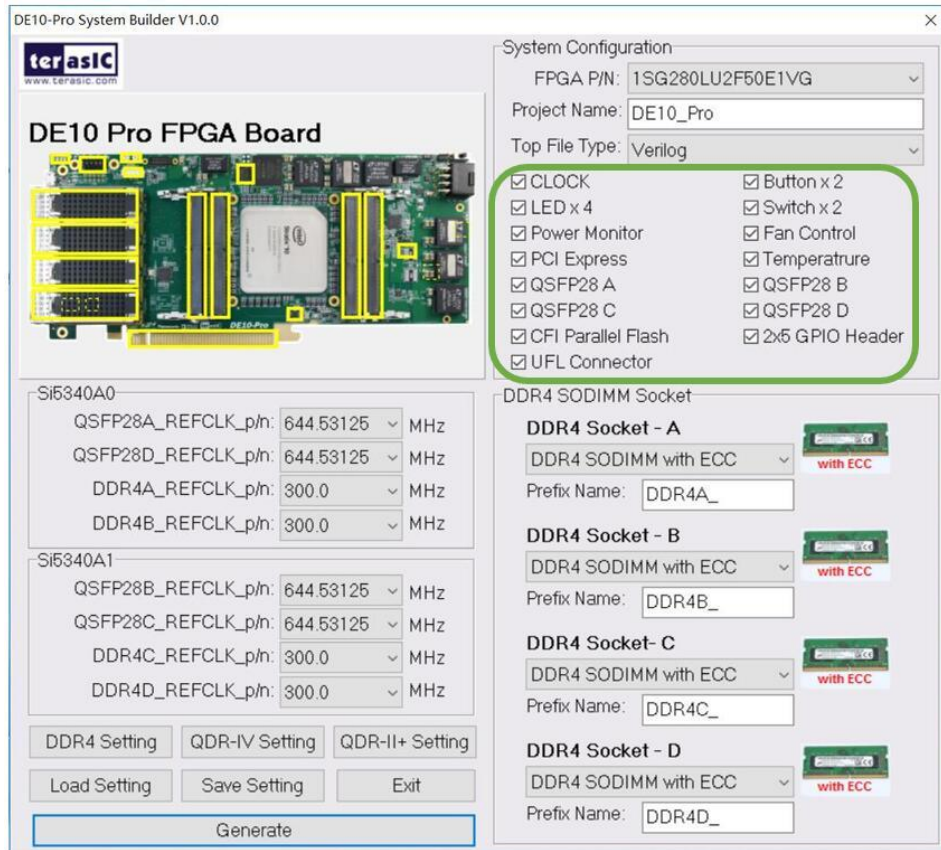

Figure 3-6 System Configuration Group

■ Programmable Clock Generator

There are two external clock generator Si5340A on-board that provide reference clocks for the following signals:

- QSFP28A_REFCLK
- QSFP28B_REFCLK
- QSFP28C_REFCLK
- QSFP28D_REFCLK
- DDR4A_REFCLK
- DDR4B_REFCLK
- DDR4C_REFCLK
- DDR4D_REFCLK

To use these clock, users can select the desired frequency on the Si5340A0 and Si5340A1 groups, as shown in **Figure 3-7**. DDR4 or QSFP28 must be checked before

users can start to specify the desired frequency in the programmable oscillators.

As the Quartus project is created, System Builder automatically generates the associated controller according to users' desired frequency in Verilog which facilitates users' implementation as no additional control code is required to configure the programmable oscillator.

Note: If users need to dynamically change the frequency, they would need to modify the generated control code themselves.

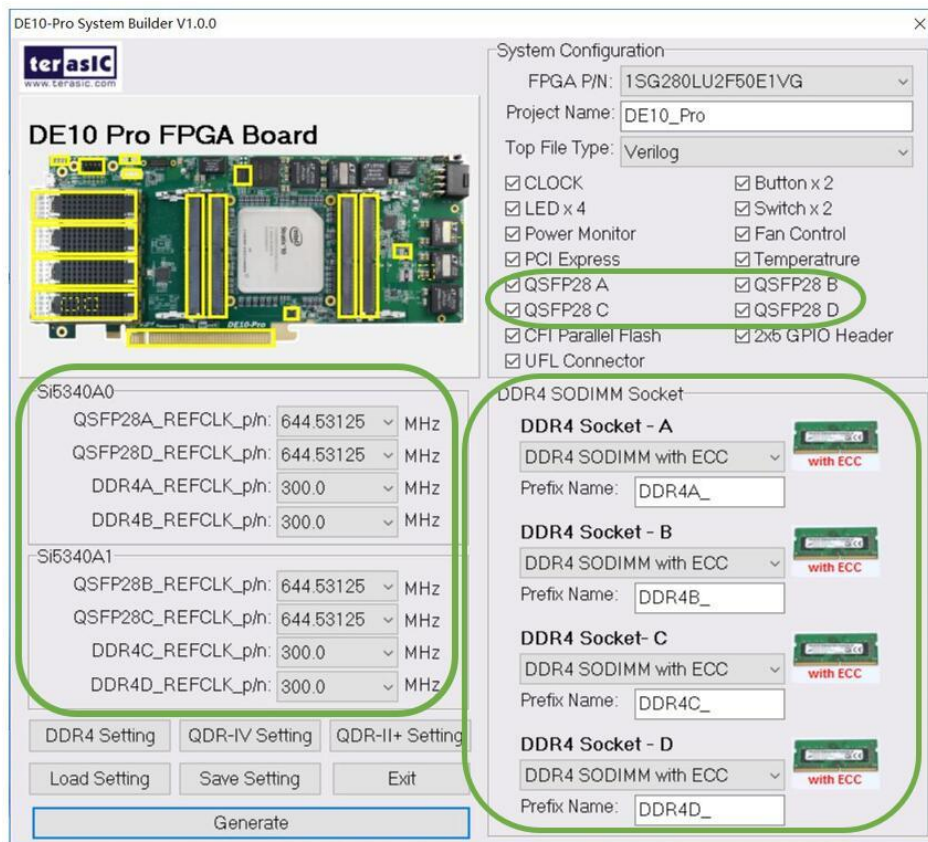

Figure 3-7 External programmable oscillators

■ Project Setting Management

The System Builder also provides functions to restore default DDR4/QDR-II+/QDR-IV setting, load a pre-saved setting, and save board configuration file, as shown in **Figure 3-8**. Users can save the current board configuration information into a .cfg file and load it into the System Builder later.

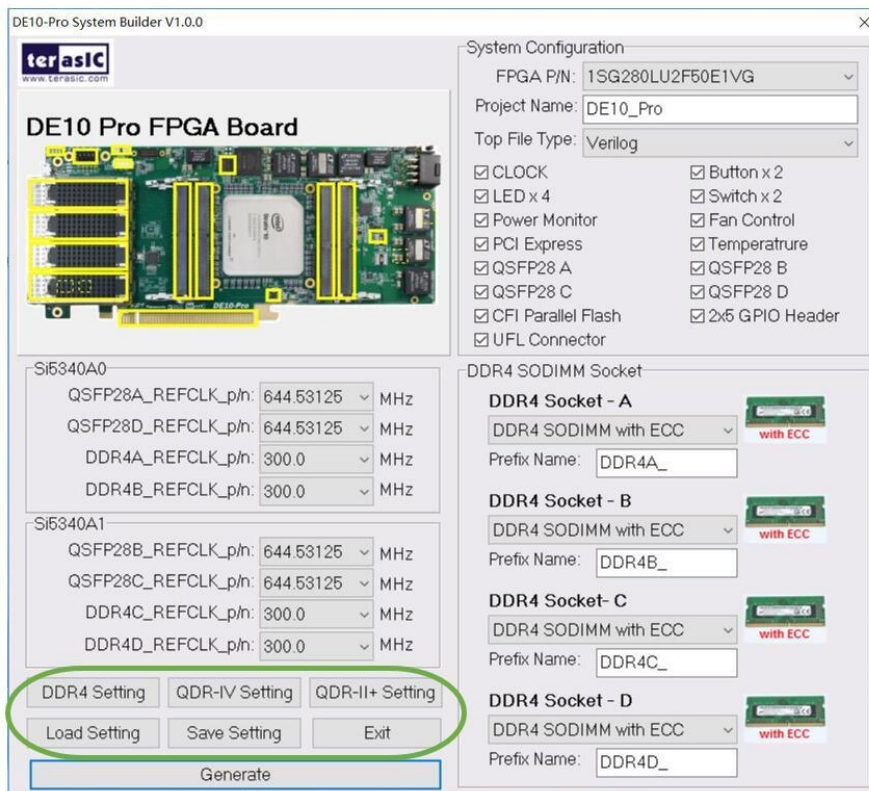

Figure 3-8 Project Settings

■ Project Generation

When users press the Generate button, the System Builder will generate the corresponding Quartus Prime files and documents as listed in the **Table 3-** directory specified by the user.

Table 3-1 Files generated by the System Builder

No.	Filename	Description
1	<Project name>.v or <Project name>.vhd	Top Level Verilog/VHDL File for Quartus Prime
2	si5340_controller (*)	Si5340A Clock Generator Controller IP
3	<Project name>.qpf	Quartus Prime Project File
4	<Project name>.qsf	Quartus Prime Setting File

5	<Project name>.sdc	Synopsis Design Constraints File for Quartus Prime
6	<Project name>.htm	Pin Assignment Document

(* The si5340_controller is a folder which contains the Verilog files for the configuration of Si5340A clock generator chips.

Users can add custom logic into the project and compile the project in Quartus Prime to generate the SRAM Object File (.sof).

The Si5340A controllers will be instantiated in the Quartus Prime top-level file, as listed below:

```

//=====
// Configure SI5340A
//=====
`define XCVR_REF_644M53125 4'h0
`define XCVR_REF_322M265625 4'h1
`define XCVR_REF_250M 4'h2
`define XCVR_REF_125M 4'h3
`define XCVR_REF_100M 4'h4

`define MEM_REF_300M 4'h0 // for DDR4 2400
`define MEM_REF_275M 4'h1 // for QDR11+ 550MHz
`define MEM_REF_266M667 4'h2 // for DDR4 2133 and QDR1V 1066Mhz
`define MEM_REF_233M333 4'h3 // for DDR4 1866
`define MEM_REF_166M667 4'h4 // for DDR4 2666

wire si5340a_controller_start;
assign si5340a_controller_start = ~BUTTON[0];

wire si5340a_config_done;
wire si5340a0_config_done;
wire si5340a1_config_done;
assign si5340a_config_done = si5340a0_config_done & si5340a1_config_done;

// Configure SI5340A0
DE10PRO_SI5340A_CONFIG si5340a0_controller(
.iCLK(CLK_50_B2C),
.iRST_n(CPU_RESET_n),
.iStart(si5340a_controller_start),
.iXCVR0_REFCLK(`XCVR_REF_644M53125),//QSFP28-D
.iXCVR1_REFCLK(`XCVR_REF_644M53125),//QSFP28-A
.iMEM0_REFCLK(`MEM_REF_300M),//DDR4-Socket-B
.iMEM1_REFCLK(`MEM_REF_300M),//DDR4-Socket-A
.I2C_CLK(SI5340A0_I2C_SCL),
.I2C_DATA(SI5340A0_I2C_SDA),
.oPLL_REG_CONFIG_DONE(si5340a0_config_done)
);

assign SI5340A0_OE_n = 1'b0;
assign SI5340A0_RST_n = CPU_RESET_n;

// Configure SI5340A1
DE10PRO_SI5340A_CONFIG si5340a1_controller(
.iCLK(CLK_50_B2C),
.iRST_n(CPU_RESET_n),
.iStart(si5340a_controller_start),
.iXCVR0_REFCLK(`XCVR_REF_644M53125),//QSFP28-B
.iXCVR1_REFCLK(`XCVR_REF_644M53125),//QSFP28-C
.iMEM0_REFCLK(`MEM_REF_300M),//DDR4-Socket-C
.iMEM1_REFCLK(`MEM_REF_300M),//DDR4-Socket-D
.I2C_CLK(SI5340A1_I2C_SCL),
.I2C_DATA(SI5340A1_I2C_SDA),
.oPLL_REG_CONFIG_DONE(si5340a1_config_done)
);

assign SI5340A1_OE_n = 1'b0;
assign SI5340A1_RST_n = CPU_RESET_n;

```

The following clock information also be automatically added in .sdc file.

```

create_clock -period "644.531250 MHz" [get_ports QSFP28A_REFCLK_p]
create_clock -period "644.531250 MHz" [get_ports QSFP28B_REFCLK_p]
create_clock -period "644.531250 MHz" [get_ports QSFP28C_REFCLK_p]
create_clock -period "644.531250 MHz" [get_ports QSFP28D_REFCLK_p]
create_clock -period "300.000000 MHz" [get_ports DDR4A_REFCLK_p]
create_clock -period "300.000000 MHz" [get_ports DDR4B_REFCLK_p]
create_clock -period "300.000000 MHz" [get_ports DDR4C_REFCLK_p]
create_clock -period "300.000000 MHz" [get_ports DDR4D_REFCLK_p]

```

If the dynamic configurations for the Si5340A clock generators are required, users need to modify the code according to users' desired behavior.

Chapter 4

CFI-Flash Programming

As you develop your own project using the Altera tools, you can program the flash memory device so that your own design loads from CFI flash memory into the FPGA on power up. This chapter will describe how to use Altera Quartus Prime Programmer Tool to program the common flash interface (CFI) flash memory device on the FPGA board.

The Stratix 10 GX/SX FPGA development board ships with the CFI flash device preprogrammed with two FPGA configurations. The two configuration images are called: **factory** image and **user** image, respectively.

4.1 FPGA Configure Operation

Below shows the procedure to enable the FPGA configuration from Flash. Users can select one boot image between factory image and user image.

1. Make sure the two default FPGA configurations data has been stored in the CFI flash.
2. Set the FPGA configuration mode to AVSTx8 mode by setting SW5/4 MSEL[2:0] as **110** as shown in **Figure 4-1**.
3. Specify the configuration of the FPGA using the default Factory Configuration Image or User Configuration Image by setting SW4 according to **Figure 4-2**. When the switch is in position “1”, the factory image is used when the system boots. When the switch is in position “0”, user image is used when the system boots.
4. Power on the FPGA board or press the MAX_RST button if board is already powered on,
5. When the configuration is completed, the green Configure Done LED will light. If there is an error, the red Configure Error LED will light.

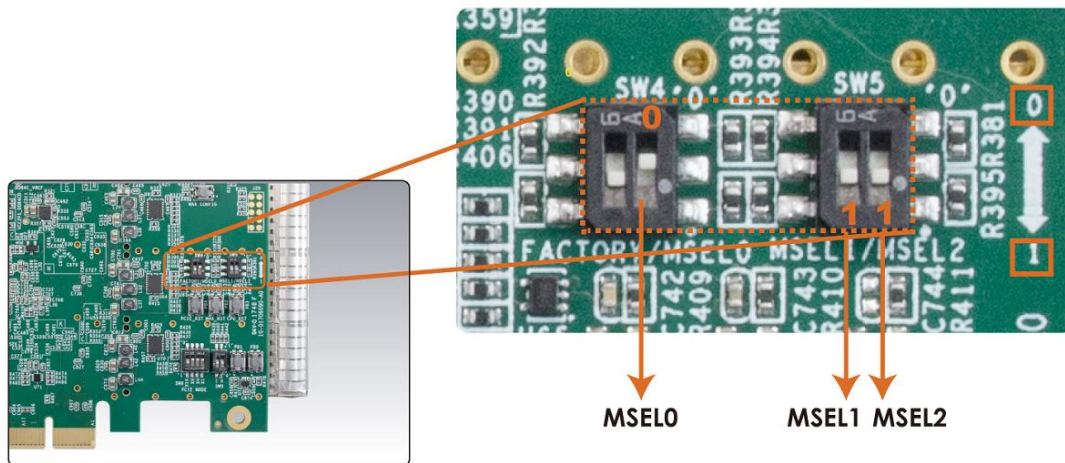
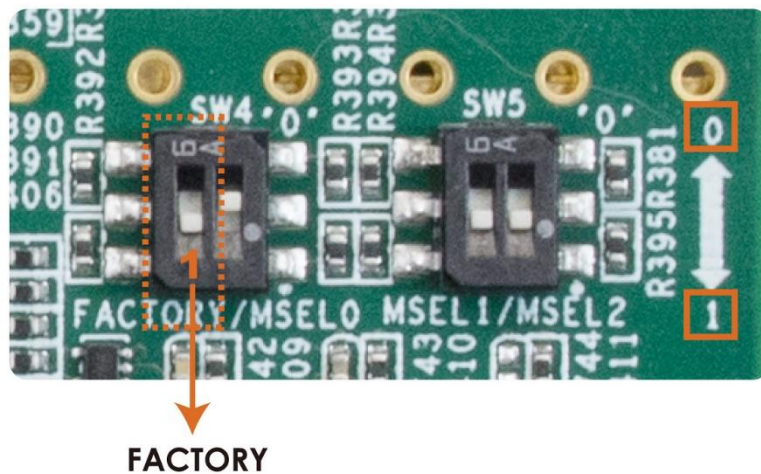

Figure 4-1 MSEL[2:0]=110



FACTORY
Figure 4-2 Configuration Image Selection

4.2 CFI Flash Memory Map

The DE10-Pro has one 1-Gbit, 16-bit data width, CFI compatible synchronous flash device for non-volatile storage of the FPGA configuration data, user Nios II code, and user data. Both MAX V CPLD and Stratix 10 GX/SX FPGA can access this Flash device.

MAX V CPLD accesses are for AVST x8 configuration of the FPGA at power-on and board reset events. It uses the PFL-II Mega function. Stratix 10 GX/SX FPGA access to the flash memory's user space is done by Nios II.

Table 4-1 shows the memory map for the on-board flash. This memory provides non-volatile storage for two FPGA bit-streams and Nios II Program, users data, as well as FPL option bits for PFL II configuration bits and board information. For the factory default code to run correctly and update designs in the user memory, this memory map address must not be altered.

Table 4-1 Flash Memory Map (Byte Address)

Block Description	Size(KB)	Address Range
Factory Board Information	128	0x00010000 – 0x0002FFFF
PFL option bits	64	0x00030000 – 0x0003FFFF
Factory hardware	44,032	0x00040000 – 0x02B3FFFF
User hardware	44,032	0x02B40000 – 0x0563FFFF
Factory software	8,192	0x05640000 – 0x05E3FFFF
User software and data	34,560	0x05E40000 – 0x07FFFFFF

The **Factory Board Information** stores the Manufacture Serial Number of the FPGA board. The Serial Number is a 13digital number with format mmmmmmmm-nnnn. Users can find the number on the serial number sticker on the FPGA board.

The **PFL option bits** contains the image location of the **Factory hardware** and **User hardware**, so the PLF II IP in the MAX can know where to find the FPGA configuration data. If developers erase all flash content, [please ensure that the PFL option is reprogrammed with the FPGA configuration data.](#)

For user's application, the **User hardware** must be stored with start address **0x02B40000**, and the user's software is suggested to be stored with start address **0x05E40000**. Users also can overwrite the Factory hardware and Factory software based on their application. **Factory hardware** must be stored with start address **0x00040000**, and the Factory software should be stored with start address **0x05640000**. We strongly recommend users to use the batch file in the **Flash_Restored** folder to write the hardware and software data into the CFI-Flash.

4.3 Flash Example Designs

There are four flash example designs and one programming batch folder in the Demonstration folder under the System CD as shown in **Table 4-2**.

Table 4-2 Flash Example Design

Example Folder	Description
Flash_Programming	This is the flash programming design. It is used to write data into FLASH by a Quartus Programmer.
Flash_Factory	A simple example design. Its FPGA configure data and Nios II codes are stored in the Factory Image Area.
Flash_User	A simple example design. Its FPGA configure data and Nios II codes are stored in the User Image Area.
Flash_Tool	A Nios II program shows how to access flash content.
Flash_Restored	A batch file used for to programming Flash_Factory and the Flash_User project into CFI Flash.

Figure 4-3 shows the relationship between the three examples – **Flash_Programming**, **Flash_Factory** and **Flash_User**. The **Flash_Programming** example is used to write data into the CFI Flash on the FPGA Board. The **Flash_Factory** and **Flash_User** are simple designs with Nios II processor. These two designed are written into CFI-Flash so they are selected to configure the FPGA when the FPGA is powered on.

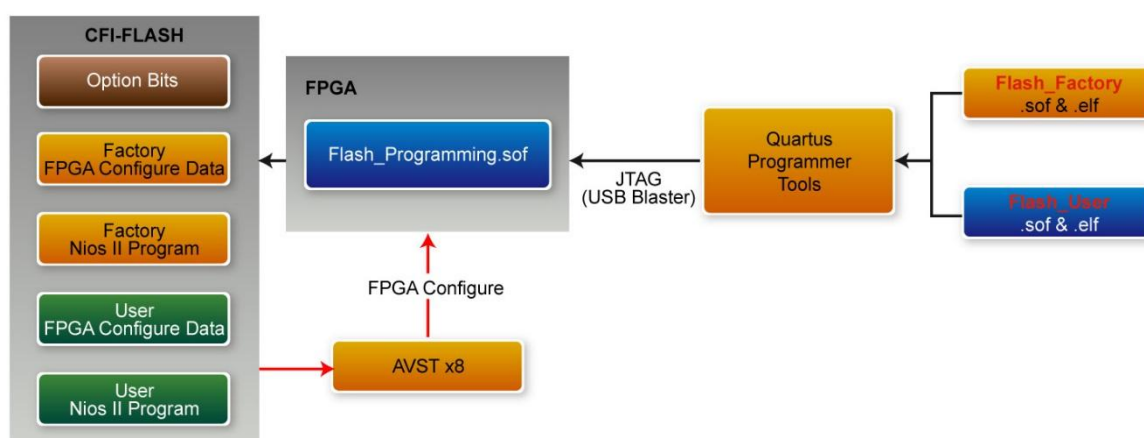

Figure 4-3 Relationship between three flash examples

The **Flash_Tool** is designed to show how to access flash via the Nios II processor. The design shows how to erase flash and read flash content.

4.4 Flash_Programming Example

The **Flash_Programing** project is designed to program CFI flash by a Quartus Programmer. In the project, Intel Parallel Flash Loader II IP is used to program the CFI-Flash. **Figure 4-4** shows the Generic Setting in the IP. “Flash Programming” operation mode is used, and “CFI Parallel Flash” is selected. **Figure 4-5** shows the Flash Interface Setting. “CFI 1 Gbit” is selected. The DE10-Pro.sof generated by this program is used in the flash programming batch files located in the **Flash_Restored** Folder.

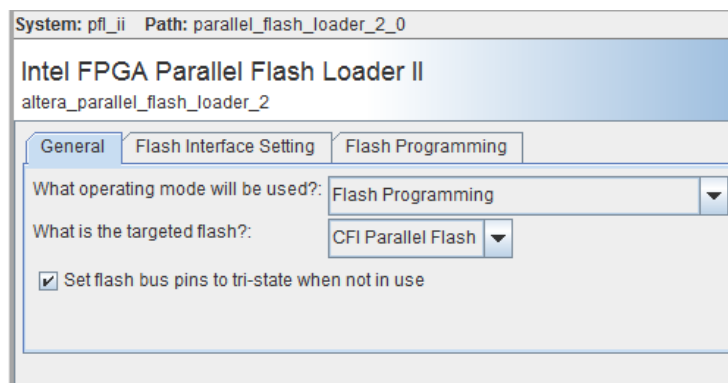

Figure 4-4 General Setting in PFL II IP

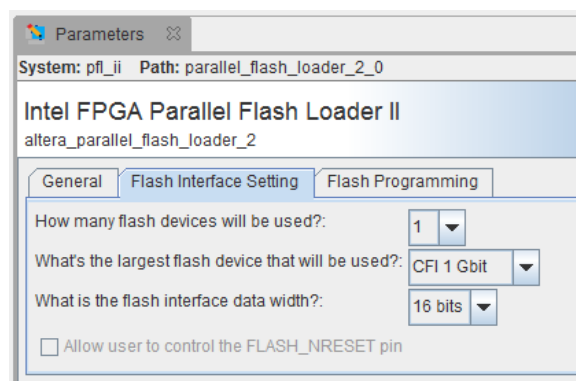

Figure 4-5 Flash Interface Setting in PFL II IP

4.5 Flash_Factory Example

The **Flash_Factory** is designed to show how to create a Nios II code which is booted from the Factory Software location in the CFI Flash when the board is powered on. This project's FPGA configuration data and Nios II code are stored in the Factory Hard area and Factory Software area of the CFI Flash when the FPGA board is shipped.

To develop this kind of boot code, first, developers need to include the Tri-State Conduit Bridge and the Generic Tri-State Controller in the **Platform Designer** (formerly Qsys) to implement the flash controller function, and connect the Nios II processor's data bus and instruction bus to the flash controller as shown in **Figure 4-6**. Then, specify the Factory Software Location **0x05640000** as Reset Vector in the Nios II Processor component as shown in **Figure 4-7**. Finally, developers need to uncheck the **allow_code_at_reset** and **enable_alt_load** options in the BSP editor under of Nios II IDE tool (Nios II Software Builder Tools for Eclipse) as shown in **Figure 4-8**.

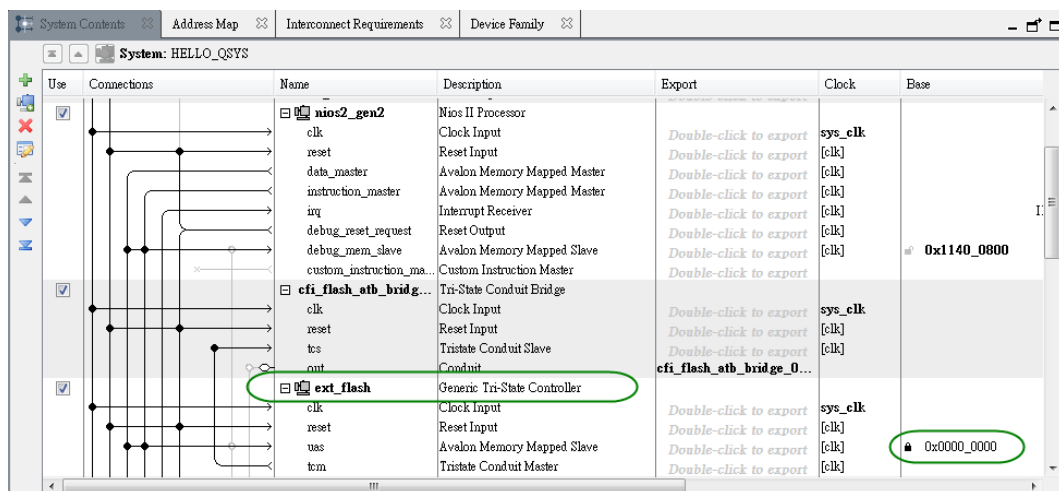

Figure 4-6 Flash Controller Settings in Platform Designer (formerly Qsys)

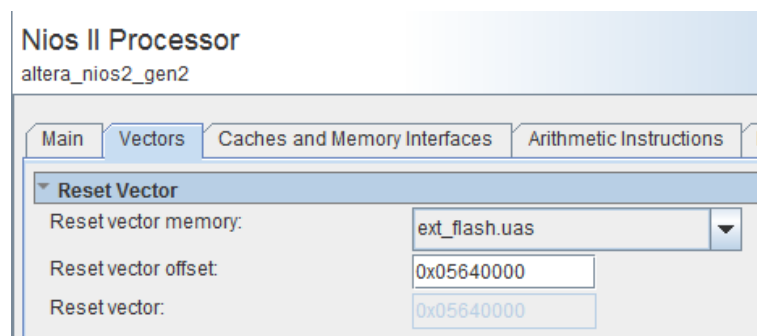

Figure 4-7 Factory Software Reset Vector Settings for NIOS II Processor

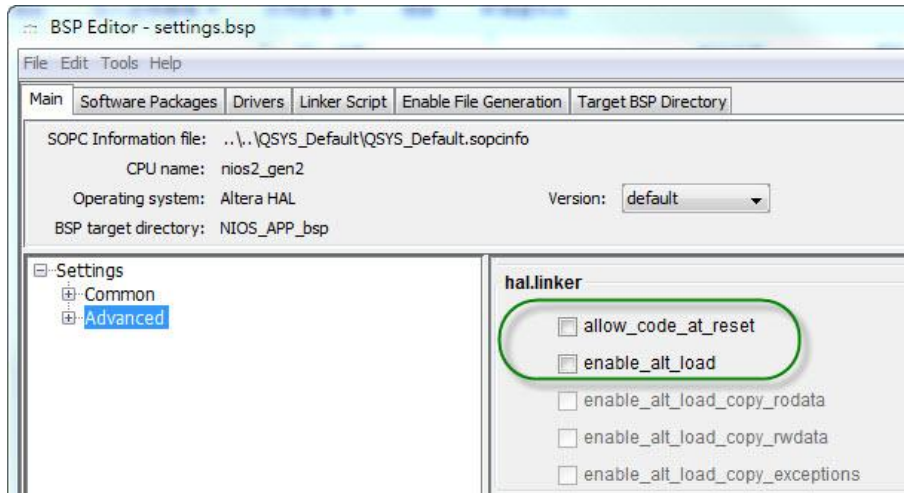

Figure 4-8 BSP Editor in Nios II IDE

4.6 Flash_User Example

The **Flash_User** project is similar with the above **Flash_Factory** example code. This project's FPGA configuration data and Nios II code are stored in the User Hard area and User Software area when the FPGA board is shipped.

The major difference between the **Flash_User** and **Flash_Factory** is the Reset Vector address in the Nios II processor component and the LED control code in Nios II program. The User Software Location **0x05E40000** is used as Reset Vector as shown in **Figure 4-9**.

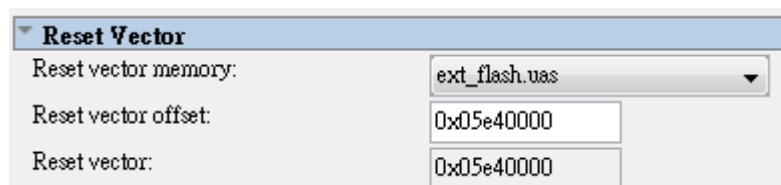
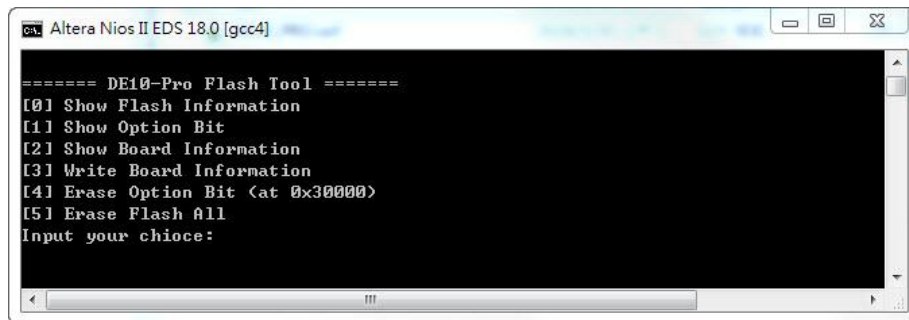

Figure 4-9 User Software Reset Vector Settings for NIOS II Processor

4.7 Flash_Tool Example

This example shows how the Nios II program accesses the FLASH. **Figure 4-10** shows a screenshot of the Flash_Tool menu shown under Nios II terminal.



```
==== DE10-Pro Flash Tool ====
[0] Show Flash Information
[1] Show Option Bit
[2] Show Board Information
[3] Write Board Information
[4] Erase Option Bit (at 0x30000)
[5] Erase Flash All
Input your choice:
```

Figure 4-10 Screenshot of Flash_Tool menu

The tools provide the following functions:

- Show CFI Flash Size
- Show Option bits used by AVST x8 Configuration
- Read Serial Number from the CFI Flash
- Erase Serial Number to the CFI flash
- Erase option bits used by AVST x8
- Erase whole flash

4.8 Programming Batch File

The **Flash_Restored** folder includes batch files to program the **Factory** image and **User** image into the CFI flash. **Figure 4-11** shows the contents of the **Flash_Restored** folder. The **factory** subfolder includes the .sof & .elf files generated by the **Flash_Factory** project. The **user** subfolder includes the .sof & .elf files generated by the **Flash_User** project. DE10_Pro.sof is generated by the **Flash_Programming** project.

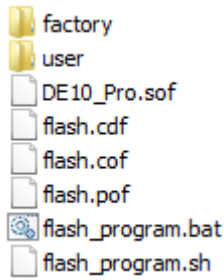

Figure 4-11 Flash_Restored folder content

The `flash_program.bat` is the top batch file for flash programming. The batch file will configure the FPGA with `DE10_Pro.sof` (Parallel Flash Loader II IP) and launch `flash_program.sh` Nios II command batch file to perform the following tasks:

1. Use Nios II utilities **elf2flash** and **nios2-elf-objcopy** to convert **Factory** Nios II code and **User** Nios II code to `factory_sw.hex` and `user_sw.hex`, respectively.
2. Use **quartus_cpf** utility according to a given configuration file **flash.cof** to merger all files (`factory_sw.hex`, `user_sw.hex`, `factory .sof` file, `user .sof` file, and option bit) into a single file **flash.pof**.
3. Use **jtagconfig** utility to adjust jtag speed.
4. Use **quartus_pgm** utility to program flash with `flash.pof`.

Developers can copy their `.sof` & `.elf` files into the `factory` folder or the `user` folder, and launch the `flash_program.bat` to program their code into the CFI-Flash.

4.9 Restore Factory Settings

This section describes how to restore the original **Factory** image and **User** image into the flash memory device on the FPGA development board. A programming batch file located in the **Flash_Restored** folder is used to restore the flash content. Performing the following instructions can restore the flash content:

1. Make sure the Nios II EDS and USB-Blaster II driver are installed.
2. Make sure the FPGA board and PC are connected with an USB Cable.
3. Power on the FPGA board.
4. Copy the "Demonstrations/Flash_Restored" folder under the CD to your PC's local drive.
5. Execute the batch file `flash_program.bat` to start flash programming.

After restoring the flash, perform the following procedures to test the restored boot code.

1. Power off the FPGA Board.
2. Set FPGA configuration mode as AVSTx8 Mode by setting SW4/5 MSEL[2:0] to **110**.
3. Specify configuration of the FPGA to Factory Hardware by setting the FACTORY_LOAD dip in SW4 to the '1' position.
4. Power on the FPGA Board, and the Configure Done LED should light up.

The batch file converts the **Factory** and **User** .sof/.elf and PFL option bit into a flash.pof file and use Quartus Programmer to program the CFI-Flash with the generated flash.pof. The **factory** subfolder includes DE10_Pro.sof and NIOS_APP.elf files generated by **Flash_Factory** project, and the **user** subfolder includes DE10_Pro.sof and HELLO_NIOS.elf files generated by **Flash_User** project. The DE10_Pro.sof under the **Flash_Restored** folder is used to program flash by Quartus Programmer.

Chapter 5

Peripheral Reference Design

This chapter introduces DE10-Pro peripheral interface reference designs. It mainly introduces Si5340A chip which is a programmable clock generator. We provide two ways (Pure RTL IP and Nios II System) respectively to show how to control Si5340A to output desired frequencies, as well as how to control the fan speed. The source codes and tools of these examples are all available in the System CD.

5.1 Configure Si5340A in RTL

There are two Silicon Labs Si5340A clock generators on DE10-Pro FPGA board can provide adjustable frequency reference clock (See **Figure 5-1**) for QSFP28 connectors and memory modules (DDR4, QDR-II+, QDR-IV). Each Si5340A clock generator can output four differential frequencies from 100Hz ~ 712.5Mhz though I2C interface configuration. This chapter will show you how to use FPGA RTL IP to configure each Si5340A PLL and generate users desired output frequency to each peripheral. In the following instruction, the two Si5340A chips will be named as Si5340A0 and Si5340A1 respectively.

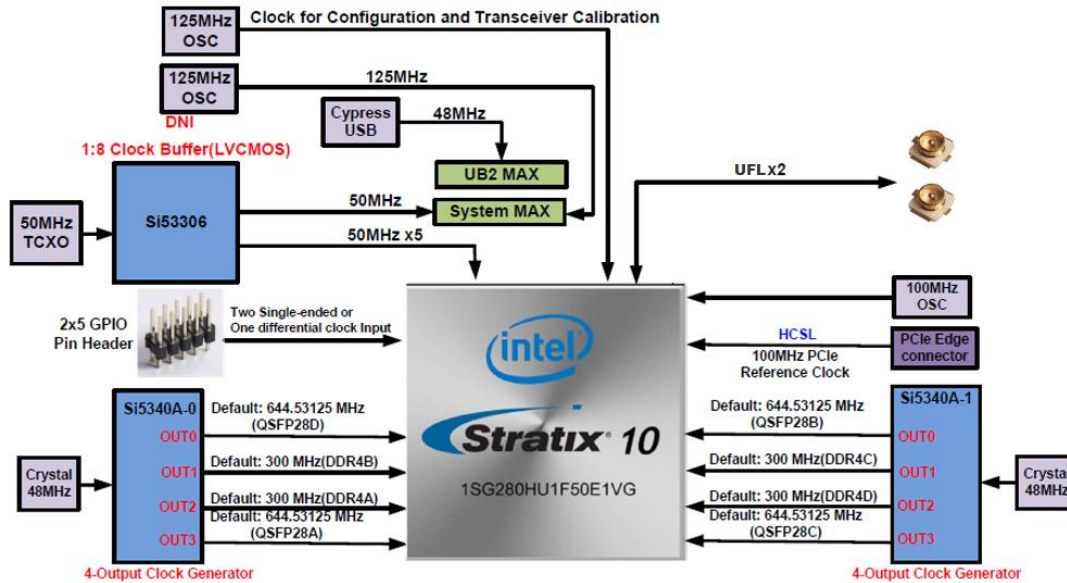

Figure 5-1 The clock tree of the DE10-Pro

■ Creating Si5340A Control IP

The Si5340A control IP is located in the folder: "\\Demonstrations\si5340_control_ip" in the System CD. Developers can use the IP directly in their Quartus top. Developers can refer to the example in Demonstrations/Clock_Controller folder. This example shows how to instantiate the IP in Quartus top project.

Also, System Builder tool (located in System CD) can be used to help developer to set Si5340A to output desired frequencies, and generate a Quartus project with control IP. In the System Builder window, users can select desired frequencies as shown in **Figure 5-2**. Developers can click the “DDR4 Setting”, “QDR-IV Setting”, or “QDR-II+ setting” to user pre-setting output frequency for various memory modules. Then, modify the output frequency by selecting a desired output frequency in the pull down menu. For details about the System Builder, please refer to Chapter 3 – System Builder.

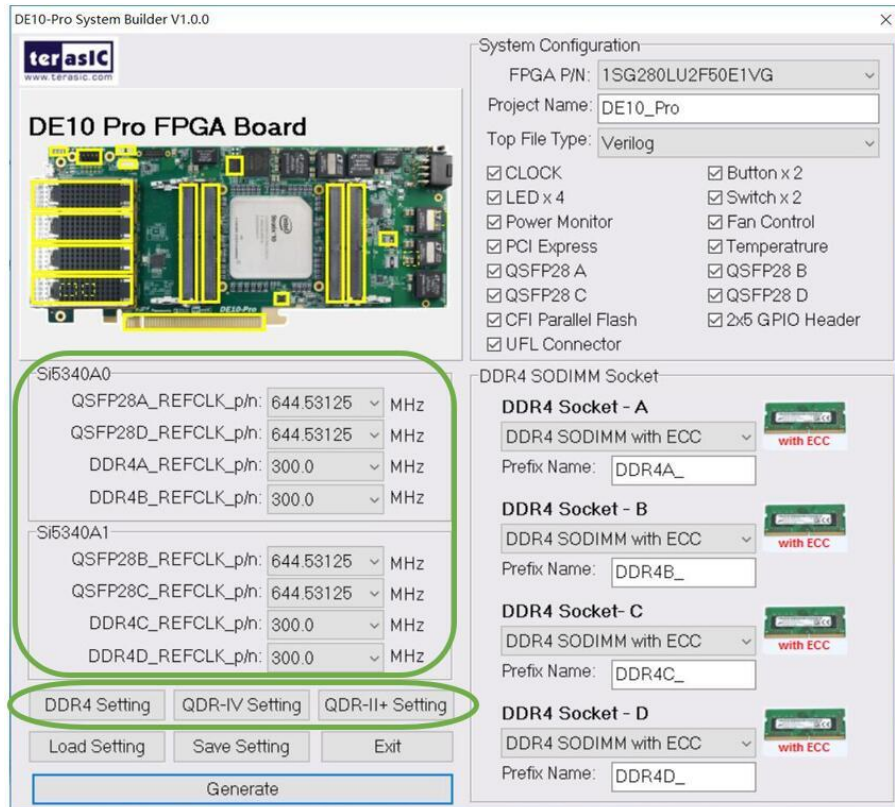

Figure 5-2 Select Desired Si5340A output frequency

■ Using Si5340 control IP

Table 5-1 lists the instruction ports of Si5340A Controller IP.

Table 5-1 Si5340A Controller Instruction Ports

Port	Direction	Description
iCLK	input	System Clock (50Mhz)
iRST_n	input	Synchronous Reset (0: Module Reset, 1: Normal)
iStart	input	Start to Configure (positive edge trigger)
iXCVR0_REFCLK iXCVR1_REFCLK iMEM0_REFCLK iMEM1_REFCLK	input	Setting Si5340A Output Channel Frequency Value
oPLL_REG_CONFIG_DONE	output	Si5340 Configuration status (0: Configuration in Progress, 1:

		Configuration Complete)
I2C_DATA	inout	I2C Serial Data to/from Si5340A
I2C_CLK	output	I2C Serial Clock to Si5340A

As shown in **Table 5-2** and **Table 5-3**, both two Si5340A control IPs have preset several output frequency parameters, if users want to change frequency, users can fill in the input ports " iXCVR0_REF_CLK", " iXCVR1_REF_CLK", " iMEM0_REF_CLK", and " iMEM1_REF_CLK" with desired frequency values and recompile the project. For example, in the components Si5340A0 and Si5340A1, change

```
.iXCVR0_REFCLK(`XCVR_REF_644M53125),  
to  
.iXCVR0_REFCLK(`XCVR_REF_322M265625),
```

Recompile project, the Si5340A0 OUT0 channel (for QSFP28D) output frequency will change from 644.53125Mhz to 322.26562Mhz.

Table 5-2 Si5340A Controller Reference Clock Frequency Setting for QSFP28

iXCVR0_REFCLK iXCVR1_REFCLK Input Setting	Si5340A Channel Clock Frequency(MHz)
4'h0	644.53125
4'h1	322.265625
4'h2	250
4'h3	125
4'h4	100

Table 5-3 Si5340A Controller Reference Clock Frequency Setting for Memory

iMEM0_REFCLK iMEM1_REFCLK Input Setting	Si5340A Channel Clock Frequency(MHz)
4'h0	300
4'h1	275
4'h2	266.667
4'h3	233.333

4'h4	166.667
------	---------

Users can also dynamically modify the input parameters, and input a positive edge trigger for “iStart”, then, Si5340A output frequency can be modified.

After the manually modifying, please remember to modify the corresponding frequency value in SDC file.

■ Modify Clock Parameter for Your Own Frequency

If the Si5340A control IP built-in frequencies are not users' desired, users can refer to the below steps to the modify control IP register parameter settings to modify the IP to output a desired frequency.

1. Firstly, download ClockBuilder Pro Software (See **Figure 5-3**), which is provided by Silicon Labs. This tool can help users to set the Si5340A's output frequency of each channel through the GUI interface, and it will automatically calculate the Register parameters required for each frequency. The tool download link:

<http://www.silabs.com/products/clocksoscillators/pages/timing-software-development-tools.aspx>

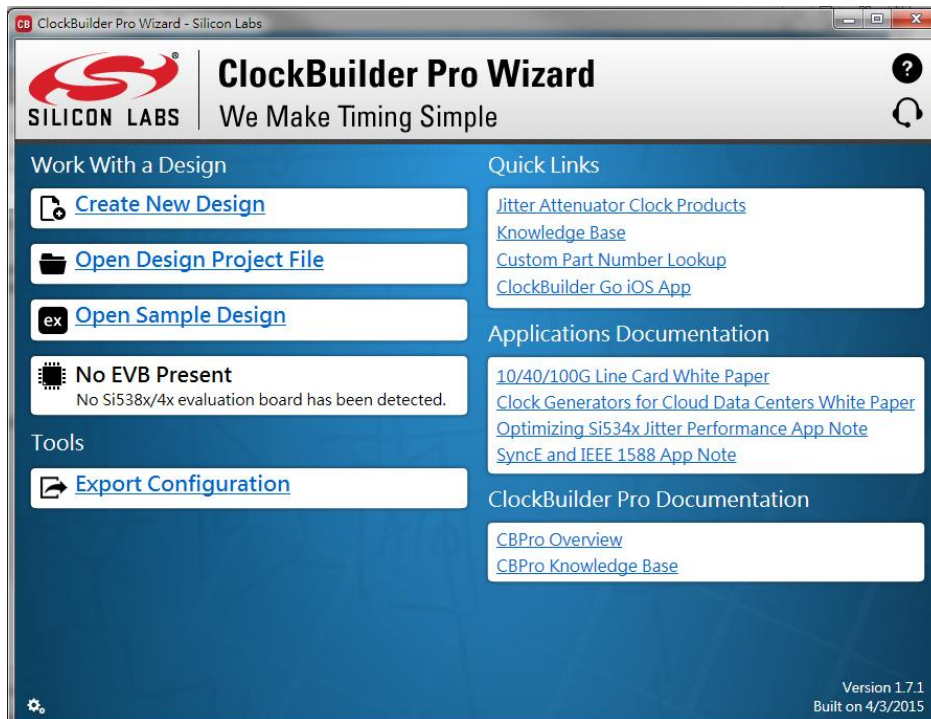

Figure 5-3 ClockBuilder Pro Wizard

2. After the installation, select Si5340, and configure the input frequency and output frequency as shown in Figure 5-4.

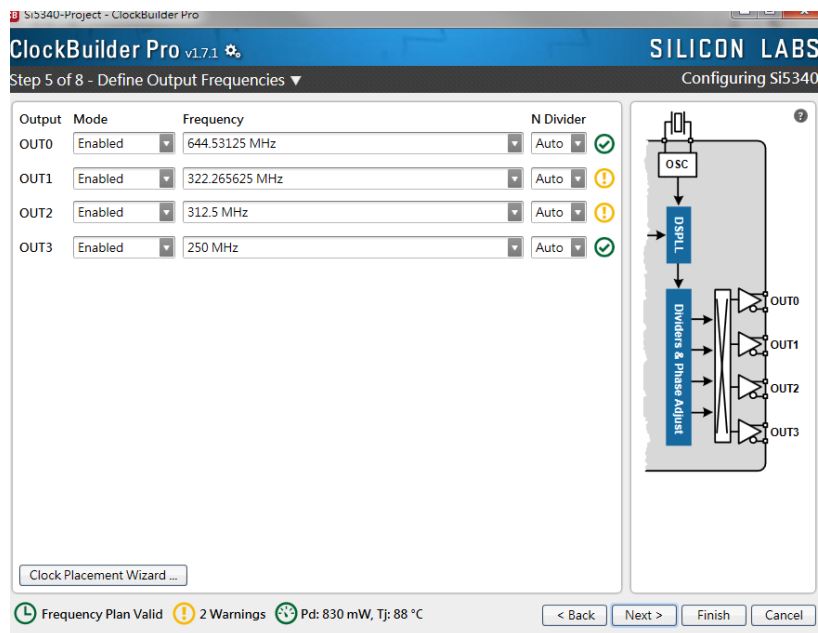

Figure 5-4 Define Output Clock Frequencies on ClockBuilder Pro Wizard

3. After the setting is completed, ClockBuilder Pro Wizard generates a Design

Report(text), which contains users setting frequency corresponding register value (See **Figure 5-5**).

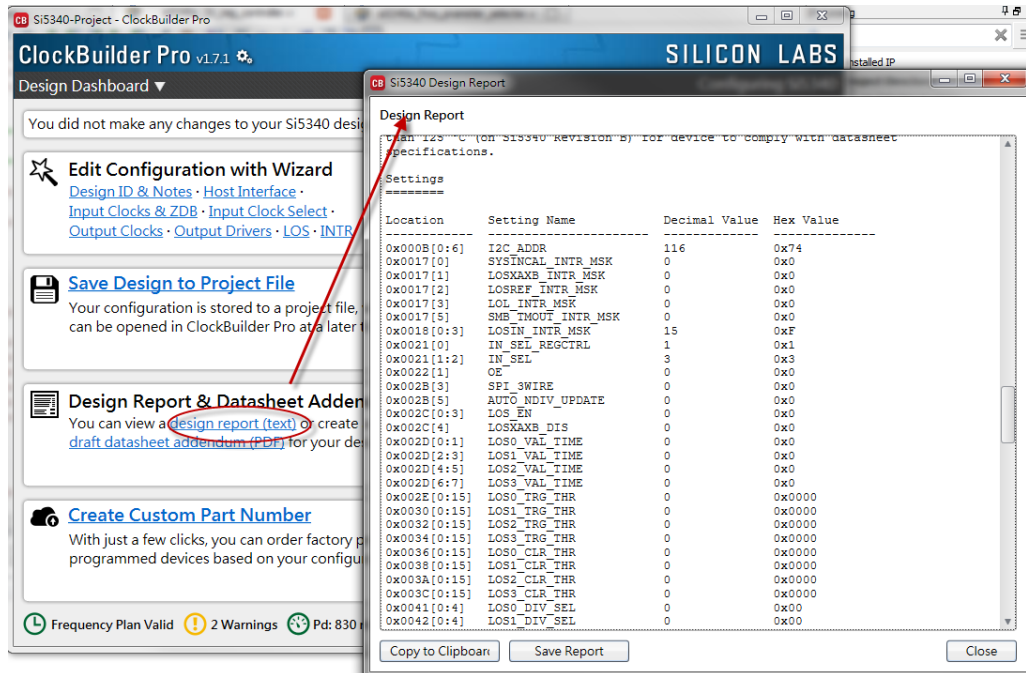

Figure 5-5 Open Design Report on ClockBuilder Pro Wizard

4. Open Si5340 control IP sub-module “si5340a_i2c_reg_controller.v “ as shown in **Figure 5-6**, refer to Design Report parameter to modify sub-module corresponding register value (See **Figure 5-7**).

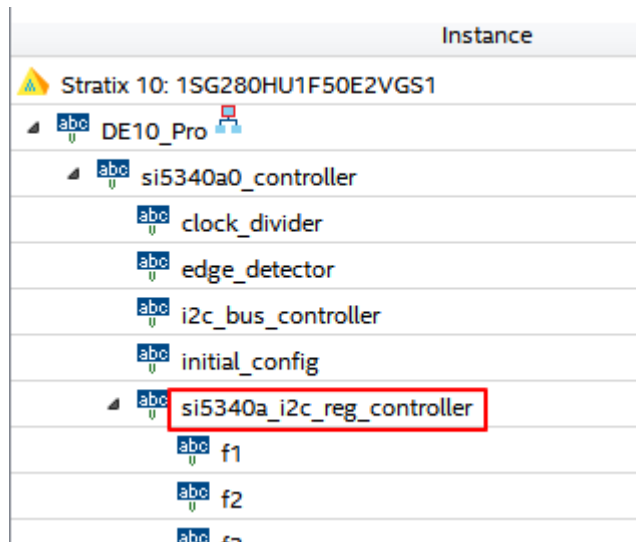

Figure 5-6 Sub-Module file "si5340a_i2c_reg_controller.v"

si5340a_i2c_reg_controller.v

```

//===== wire all reg address value end =====
//===== assign all parameter value =====
wire [3:0] LOSFB_IN_INTR_MSK = 15 ;
wire IN_SEL_REGCTRL = 1 ;
wire [1:0] IN_SEL = 3 ;

wire OUTALL_DISABLE_LOW = 1 ;
wire OUT0_PEN = 0 ;
wire OUT0_OE ;//= 1 ;
wire OUT0_RDIV_FORCE2 = 1 ;
wire [2:0] OUT0_FORMAT = 1 ;
wire OUT0_SYNC_EN = 1 ;
wire [1:0] OUT0_DIS_STATE = 0 ;
wire [1:0] OUT0_CMOS_DRV = 0 ;
wire [3:0] OUT0_CM = 12 ;
wire [2:0] OUT0_AMPL = 3 ;
wire [2:0] OUT0_MUX_SEL = 0 ;
wire [1:0] OUT0_INV = 0 ;

wire OUT1_PEN = 0 ;
wire OUT1_OE ;//= 1 ;
wire OUT1_RDIV_FORCE2 = 1 ;
wire [2:0] OUT1_FORMAT = 1 ;
wire OUT1_SYNC_EN = 1 ;

```

Design Report

Location	Setting Name	Decimal Value	Hex Value
0x000B[0:6]	I2C_ADDR	116	0x74
0x0017[0]	SYSNVAL_INTR_MSK	0	0x0
0x0017[1]	LOSXAXB_INTR_MSK	0	0x0
0x0017[2]	LOSREF_INTR_MSK	0	0x0
0x0017[3]	LOL_INTR_MSK	0	0x0
0x0017[5]	SMB_TIMEOUT_INTR_MSK	0	0x0
0x0018[0:3]	LOSIN_INTR_MSK	15	0xF
0x0021[0]	IN_SEL_REGCTRL	1	0x1
0x0021[1:2]	IN_SEL	3	0x3
0x0022[1]	OE	0	0x0
0x002B[3]	SPI_SWIRE	0	0x0
0x002B[5]	AUTO_NDIV_UPDATE	0	0x0
0x002C[0:3]	LOS_EN	0	0x0
0x002C[4]	LOSXAXB_DIS	0	0x0
0x002D[0:1]	LOS0_VAL_TIME	0	0x0
0x002D[2:3]	LOS1_VAL_TIME	0	0x0

Figure 5-7 Modify Si5340 Control IP Base on Design Report

After modifying and compiling, Si5340A can output new frequencies according to the users' setting.

Note :

1. No need to modify all Design Report parameters in si5340a_i2c_reg_controller.v/si5340b_i2c_reg_controller.v, users can ignore parameters which have value nothing to do with the frequency setting
2. After manually modifying, please remember to modify clock constrain setting in .SDC file

5.2 Nios II control for SI5340/ Temperature/ Power/Fan

This demonstration shows how to use the Nios II processor to:

- monitor system temperature with the on-board temperature sensor
- program on-board two programmable oscillators (Si5340A0 and Si5340A1)
- measure the power consumption based on the built-in power measure circuit
- control fan speed and monitor rotation speed.

■ System Block Diagram

Figure 5-8 shows the system block diagram of this demonstration. The system requires a 50 MHz clock provided from the board. The six peripherals (including one temperature sensor, two Si5340A clock generator, and two LTC2945 for 12V input power monitor and FPGA core power monitor, and one fan controller chip MAX6651) are all controlled through five I2C controllers driven by Nios II program. The Nios II program is running in the on-chip memory.

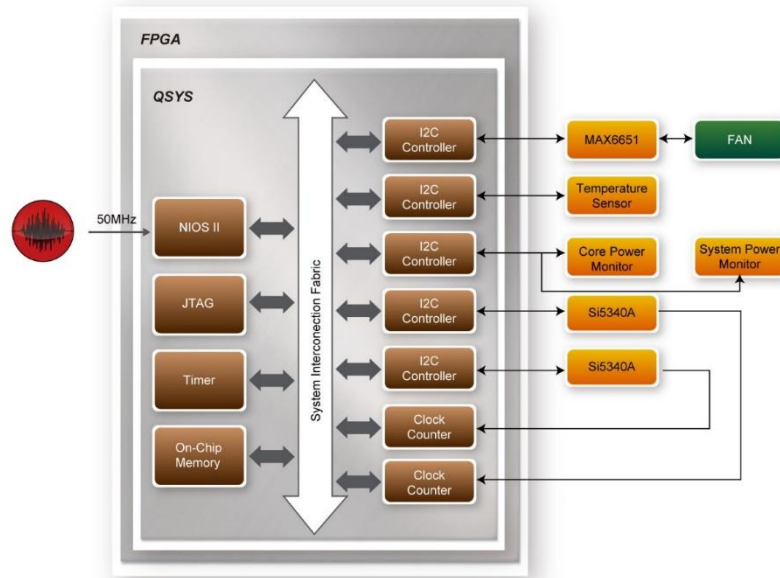
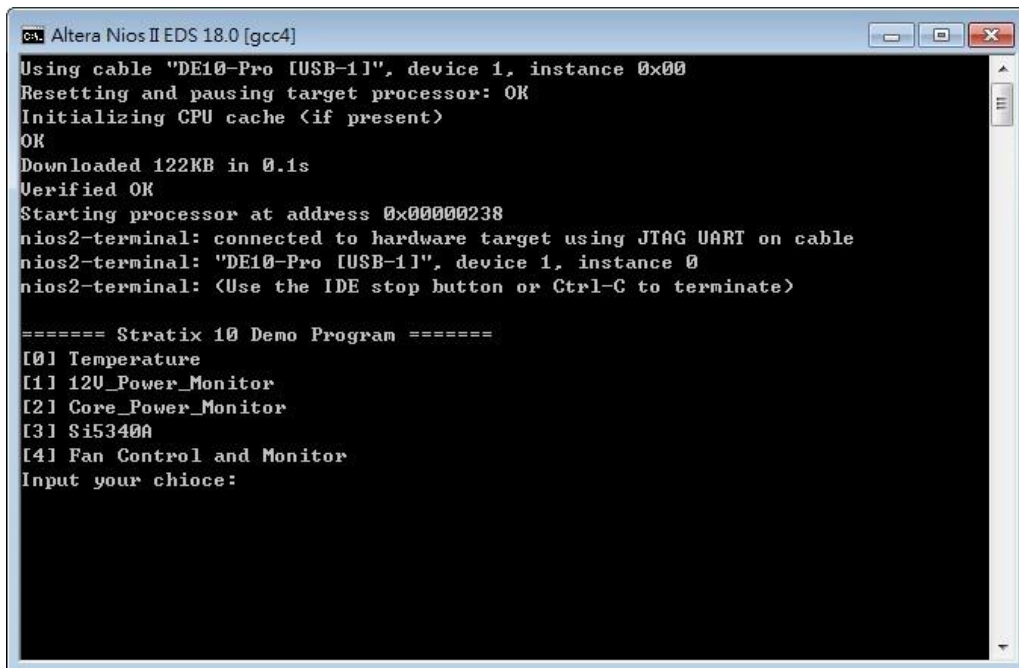

Figure 5-8 Block diagram of the Nios II Basic Demonstration

The program provides a menu in nios-terminal, as shown in **Figure 5-9** to provide an interactive interface. With the menu, users can perform the test for the temperature sensors, external PLL and power monitor. Note, pressing 'ENTER' should be followed with the user's number of choice.



```
Altera Nios II EDS 18.0 [gcc4]
Using cable "DE10-Pro [USB-1]", device 1, instance 0x00
Resetting and pausing target processor: OK
Initializing CPU cache (if present)
OK
Downloaded 122KB in 0.1s
Verified OK
Starting processor at address 0x00000238
nios2-terminal: connected to hardware target using JTAG UART on cable
nios2-terminal: "DE10-Pro [USB-1]", device 1, instance 0
nios2-terminal: <Use the IDE stop button or Ctrl-C to terminate>

===== Stratix 10 Demo Program =====
[0] Temperature
[1] 12V_Power_Monitor
[2] Core_Power_Monitor
[3] Si5340A
[4] Fan Control and Monitor
Input your choice:
```

Figure 5-9 Menu of Demo Program

In temperature test, the program will display local temperature and remote temperature. The remote temperature is the FPGA temperature, and the local temperature is the board temperature where the temperature sensor located.

There are two power monitor chips (LTC2945) embedded on the board to monitor in real-time the input 12V power and 0.9V FPGA core power. The U55 LTC2945 is used to monitor 12V input power with two sense resistors 0.003 ohm parallel. Its I2C device address is 0xD4/D5. The U67 LTC2945 is used to monitor the 0.9V FPGA core power with two sense resistors 0.00025 ohm parallel. Its I2C device address is 0x0A/0x0B. These two chips share the same I2C bus.

In the external PLL programming test, the program will program the PLL first, and subsequently use Terasic custom **Platform Designer** (formerly Qsys) CLOCK_COUNTER IP to count the clock count in a specified period to check whether the output frequency as changed as configured. To avoid a Quartus Prime compilation error, dummy transceiver controllers are created to receive the clock from the external PLL. Users can ignore the functionality of the transceiver controller in the demonstration. For Si5340A0/Si5340A1 programming, please note the device I2C address is 0xEE. The program can control the Si5340A0 to configure the output frequency of QSFP28A, QSFP28D, DDR4A and DDR4B REFCLK, and control the

Si5340A1 to configure the output frequency of QSFP28B, QSFP28C, DDR4C and DDR4D REFCLK according to your choice.

In the fan controlling and monitoring test, fan control chip MAX6651 is used to drive two fans with same power strength, and monitor the speed of the two fans individually. In this test, developers can read current fan rotation speed (RPM: Rotation per Minutes) and change the rotation speed of the two fans.

■ Design Tools

- Quartus Prime 18.1.1 Pro Edition

■ Demonstration File Locations

- Hardware project directory: NIOS_BASIC_DEMO
- Bitstream used: NIOS_BASIC_DEMO.sof
- Software project directory: NIOS_BASIC_DEMO \software
- Demo batch file: NIOS_BASIC_DEMO\demo_batch\NIOS_BASIC_DEMO.bat, NIOS_BASIC_DEMO.sh

■ Demonstration Setup and Instructions

- Make sure Quartus Prime and Nios II are installed on your PC.
- Power on the FPGA board.
- Use the USB Cable to connect your PC and the FPGA board and install USB Blaster II driver if necessary.
- Execute the demo batch file “test.bat” under the batch file folder, NIOS_BASIC_DEMO\demo_batch.
- After the Nios II program is downloaded and executed successfully, a prompt message will be displayed in nios2-terminal.
- For the temperature test, please input key ‘0’ and press ‘Enter’ in the nios-terminal, as shown in **Figure 5-10**.
- For the 12V input power monitor test, please input key ‘1’ and press ‘Enter’ in the nios-terminal, the Nios II console will display the current values of voltage, current and power as shown in **Figure 5-11**.

- For the FPGA core power monitor test, please input key '2' and press 'Enter' in the nios-terminal, the Nios II console will display the current values of voltage, current and power as shown in **Figure 5-12**.
- For the PLL Si5340A0 and Si5340A1 test, please input key '3' and input the desired output frequency for eight clock sources, as shown in **Figure 5-13**.
- For fan controlling and monitoring, please input key '4' and press "Enter". There is a sub menu appearing as shown in **Figure 5-14**. In the sub menu, select '0' can read current fan speed as shown in **Figure 5-15**. Select '1' can specify the fan driving strength with given a value from 1 to 100 as shown in **Figure 5-16**. 100 is the maximal strength.

```

Altera Nios II EDS 18.0 [gcc4]
Starting processor at address 0x00000238
nios2-terminal: connected to hardware target using JTAG UART on cable
nios2-terminal: "DE10-Pro [USB-1]", device 1, instance 0
nios2-terminal: <Use the IDE stop button or Ctrl-C to terminate>

===== Stratix 10 Demo Program =====
[0] Temperature
[1] 12V_Power_Monitor
[2] Core_Power_Monitor
[3] Si5340A
[4] Fan Control and Monitor
Input your choice:0

I2C core is enabled!
I2C core is disabled!
Local Temperature:42°C
Remote Temperature:41°C
Temperature Test:PASS
===== Stratix 10 Demo Program =====
[0] Temperature
[1] 12V_Power_Monitor
[2] Core_Power_Monitor
[3] Si5340A
[4] Fan Control and Monitor
Input your choice:

```

Figure 5-10 Temperature Demo

```
Altera Nios II EDS 18.0 [gcc4]
I2C core is disabled!
Local Temperature:42°C
Remote Temperature:41°C
Temperature Test:PASS
===== Stratix 10 Demo Program =====
[0] Temperature
[1] 12V_Power_Monitor
[2] Core_Power_Monitor
[3] Si5340A
[4] Fan Control and Monitor
Input your choice:1

I2C core is enabled!
==== Power (12V) Monitor Test ====
Current      = 2.034 A
VIN_Voltage  = 11.953 V
Power        = 24.310 W
12V_Power_Monitor Test:PASS
===== Stratix 10 Demo Program =====
[0] Temperature
[1] 12V_Power_Monitor
[2] Core_Power_Monitor
[3] Si5340A
[4] Fan Control and Monitor
Input your choice:
```

Figure 5-11 12V power monitor Demo

```
Altera Nios II EDS 18.0 [gcc4]
===== Stratix 10 Demo Program =====
[0] Temperature
[1] 12V_Power_Monitor
[2] Core_Power_Monitor
[3] Si5340A
Input your choice:2

I2C core is enabled!
==== Core Power (0.9V) Monitor Test ====
Current      = 14.203 A
VIN_Voltage  = 0.925 V
Power        = 13.141 W
Core_Power_Monitor Test:PASS
===== Stratix 10 Demo Program =====
[0] Temperature
[1] 12V_Power_Monitor
[2] Core_Power_Monitor
[3] Si5340A
Input your choice:
```

Figure 5-12 Core power monitor Demo

```

Altera Nios II EDS 18.0 [gcc4]
===== Stratix 10 Demo Program =====
[0] Temperature
[1] 120_Power_Monitor
[2] Core_Power_Monitor
[3] Si5340A
Input your choice:3
===== Si5340A Programming =====
[0] 644.531250 MHz
[1] 322.265625 MHz
[2] 250.000000 MHz
[3] 125.000000 MHz
[4] 100.000000 MHz
[5] 300.000000 MHz
[6] 275.000000 MHz
[7] 266.666992 MHz
[8] 233.332993 MHz
[9] 166.667007 MHz
[Other] exit
please select QSPF28D_REFCLK:0
please select DDR4B_REFCLK:5
please select DDR4A_REFCLK:5
please select QSPF28A_REFCLK:0
please select QSPF28B_REFCLK:0
please select DDR4C_REFCLK:5
please select DDR4D_REFCLK:5
please select QSPF28C_REFCLK:0

I2C core is enabled!

I2C core is enabled!
QSPF28D/644.531250MHz ref clock test PASS (clk1=998, clk2=12867, expected clk2=12864)
DDR4B/300.000000MHz ref clock test PASS (clk1=998, clk2=5988, expected clk2=5988)
DDR4A/300.000000MHz ref clock test PASS (clk1=998, clk2=5988, expected clk2=5988)
QSPF28A/644.531250MHz ref clock test PASS (clk1=998, clk2=12863, expected clk2=12864)
QSPF28B/644.531250MHz ref clock test PASS (clk1=998, clk2=12864, expected clk2=12864)
DDR4C/300.000000MHz ref clock test PASS (clk1=998, clk2=5988, expected clk2=5988)
DDR4D/300.000000MHz ref clock test PASS (clk1=998, clk2=5988, expected clk2=5988)
QSPF28C/644.531250MHz ref clock test PASS (clk1=998, clk2=12865, expected clk2=12864)
Si5340A Test:PASS
===== Stratix 10 Demo Program =====
[0] Temperature
[1] 120_Power_Monitor
[2] Core_Power_Monitor
[3] Si5340A
Input your choice:

```

Figure 5-13 Si5340A Demo

```
Altera Nios II EDS 18.0 [gcc4]
QSFP28B/644.531250MHz ref clock test PASS <clk1=998, clk2=12865, expected clk2=1
2864>
DDR4C/300.000000MHz ref clock test PASS <clk1=998, clk2=5988, expected clk2=5988
>
DDR4D/300.000000MHz ref clock test PASS <clk1=998, clk2=5988, expected clk2=5988
>
QSFP28C/644.531250MHz ref clock test PASS <clk1=998, clk2=12864, expected clk2=1
2864>
Si5340A Test:PASS
===== Stratix 10 Demo Program =====
[0] Temperature
[1] 12V_Power_Monitor
[2] Core_Power_Monitor
[3] Si5340A
[4] Fan Control and Monitor
Input your chioce:4

I2C core is enabled!

I2C core is enabled!
0. Read RPM
1. Set Fan Power<1~100>
2. Quit
```

Figure 5-14 Fan Menu

```
Altera Nios II EDS 18.0 [gcc4]
2864>
Si5340A Test:PASS
===== Stratix 10 Demo Program =====
[0] Temperature
[1] 12V_Power_Monitor
[2] Core_Power_Monitor
[3] Si5340A
[4] Fan Control and Monitor
Input your chioce:4

I2C core is enabled!

I2C core is enabled!
0. Read RPM
1. Set Fan Power<1~100>
2. Quit
0
RPM0: 6300 , RPM1: 6300
RPM0: 6360 , RPM1: 6360
RPM0: 6360 , RPM1: 6360
0. Read RPM
1. Set Fan Power<1~100>
2. Quit
```

Figure 5-15 Reading Fan Speed

```
Altera Nios II EDS 18.0 [gcc4]
[3] $i5340A
[4] Fan Control and Monitor
Input your chioce:4

I2C core is enabled!

I2C core is enabled!
0. Read RPM
1. Set Fan Power<1~100>
2. Quit
0
RPM0: 6300 , RPM1: 6300
RPM0: 6360 , RPM1: 6360
RPM0: 6360 , RPM1: 6360
0. Read RPM
1. Set Fan Power<1~100>
2. Quit
1
Please Enter Power 1~100 :
100
0. Read RPM
1. Set Fan Power<1~100>
2. Quit
```

Figure 5-16 Set Fan Speed

5.3 Fan Speed Control

This demo helps users quickly understand how to set the MAX6651 chip from the FPGA to control the two fans on the heatsink. In this demonstration, these two fans are called as fan0 and fan1 respectively. The MAX6651 chip can set or retrieve the RPM of fans. The two fans are driven with the same signal, but their rotation speed can be monitored individually. It can also monitor if there are any unexpected errors and determine which type of error it is. The following section will save lots of time for the development of user applications.

■ System Block Diagram

Figure 5-17 shows the system block diagram of this demo. It is necessary to configure the MAX6651 chip prior to initialization of the fan control. The MAX6651 chip uses standard I2C protocol for communication. The functions I2C_Config and I2C_Bus_Controller are used to set and monitor the RPMs of the fans, respectively. A pre-scaler is used as frequency divider for the clock frequency of the I2C. Users need to calculate the frequency based on the equations from the datasheet to control the RPM of the fans. There are three equations in the datasheet and this demo uses one of them. For other equations, please refer to the datasheet MAX6650-MAX6651.pdf in

the system CD.

The Switch[0] controls the RPMs in this demo. When the Switch[0] is set to 0, the speed is around 2000 RPM. The speed would reach about 5000 RPM if the Switch[0] is set to 1. It would take 10 ~ 30 secs of buffer time for the conversion. If an error is detected, the LED would light up Users need to press BUTTON[1] to reset the LED to turn it off.

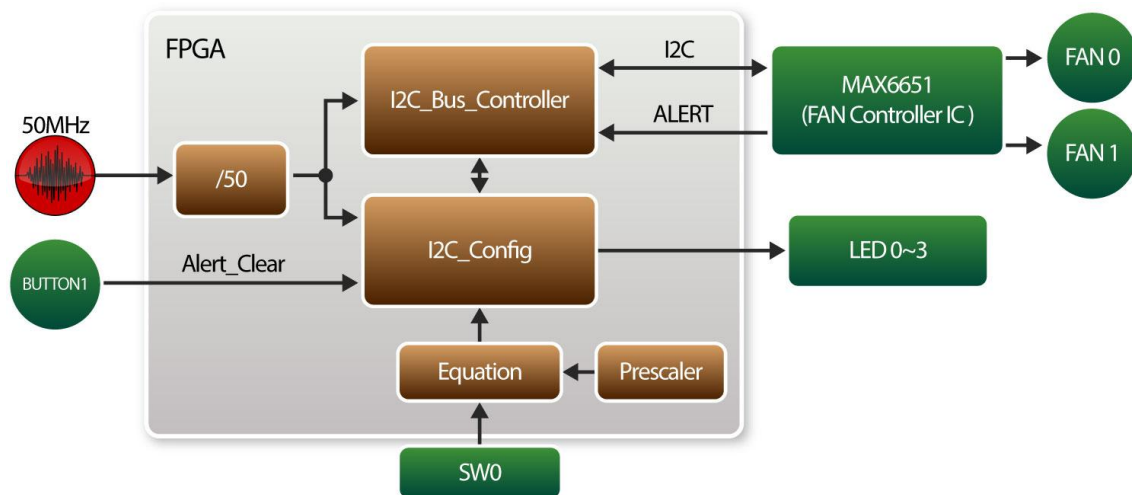

Figure 5-17 Block diagram of the fan speed control demonstration

■ Alarm Status Register Bit Assignments

When the fan operation is abnormal, the LED will light up. Users can refer to **Table 5-4** and get a better understanding about the malfunction of the fans accordingly. The status of BIT 4 ~ 7 can be ignored because BIT 4 is for MAX6651 only and BIT 5 ~ 7 are always low.

Table 5-4 Alarm-Enable Register Bit Masks

BIT	NAME	POR (DEFAULT)STATE	FUNCTION
3(LED[3])	GPIO1	0	GPIO1 Alarm. Set when GPIO1 is low
2(LED[2])	TACH	0	Tachometer Overflow Alarm

1(LED[1])	MIN	0	Minimum Output Level Alarm
0(LED[0])	MAX	0	Maximum Output Level Alarm

■ Design Tools

- Quartus Prime 18.1.1 Pro Edition

■ Demonstration Source Code

- Project Directory: Demonstrations\Fan_Controller
- Bit Stream: DE10_Pro_FAN_RTL.sof
- Demonstration Batch File: test.bat

Demo Batch File Folder: Demonstrations\Fan_controller\demo_batch

The demo batch file includes following files:

- Batch File: test.bat
- FPGA configuration File: DE10_Pro_FAN_RTL.sof

■ Demonstration Setup

- Make sure Quartus Prime Pro Edition is installed on the host PC.
- Connect the DE10-Pro and the host PC via USB cable. Install the USB-Blaster II driver if necessary.
- Power on the FPGA Board.
- Execute the demo batch file “test.bat” under the batch file folder \Fan_Controller\demo_batch.
- When SW[0] is set to 0, the RPM would slowly be adjusted to ~2000. When SW[0] is set to 1, the RPM would slowly be adjusted to ~5000.
- The detail fan monitor information can be observed through the Signaltap as shown in **Figure 5-18** and **Figure 5-19**.



Type	Alias	Name	-768	-512	-256	0	
		u0 Speed_Set[12..0]	2000				
		u0 FAN0_Speed[13..0]	2160				
		u0 FAN1_Speed[13..0]	2040				

Figure 5-18 The RPM when SW[0] is set to 0



Type	Alias	Name	-768	-512	-256	0	
		+ u0 Speed_Set[12..0]	5000				
		+ u0 FAN0_Speed[13..0]	5370				
		+ u0 FAN1_Speed[13..0]	5190				

Figure 5-19 The RPM when SW[0] is set to 1

Chapter 6

Memory Reference

Design

The FPGA development board includes four DDR4 SODIMM Sockets. Besides the standard DDR4 SODIMM module, the sockets can also be paired with Terasic's proprietary QDR-II+ and QR-IV memory module. Each socket can support the following Memory module:

- Standard DDR4-2400 4GB/8GB ECC SODIMM
- Terasic QDR-II+ 550MHz 144Mbit Memory Module. 36-bit data width
- Terasic QDR-IV 1066MHz 144Mbit Memory Module. 36-bit data width

This chapter will show three examples which use the memory controller **Stratix 10 External Memory Interfaces (Stratix 10 EMIF)** to perform memory test functions. The source codes of these examples are all available on the FPGA System CD. These three examples are:

- DDR4 SDRAM Test: Test four DDR4-2400 4GB ECC SODIMM Module.
- DDR4 SDRAM Test by Nios II: Test four DDR4-2400 4GB ECC SODIMM Module with Nios II program.
- QDRII+ SRAM Test: Test four Terasic QDR-II+ module

6.1 DDR4 SDRAM Test

This demonstration performs a memory test function on the four DDR4-2400 ECC SO-DIMM on the DE10-Pro. The memory size of each DDR4 SDRAM SO-DIMM used in this test is 4 GB.

■ Function Block Diagram

Figure 6-1 shows the function block diagram of this demonstration. There are four DDR4 SDRAM controllers. The controller uses 300.000 MHz as a reference clock. It generates one 1200MHz clock as memory clock from the FPGA to the memory and the controller itself runs at quarter-rate in the FPGA i.e. 300.000 MHz.

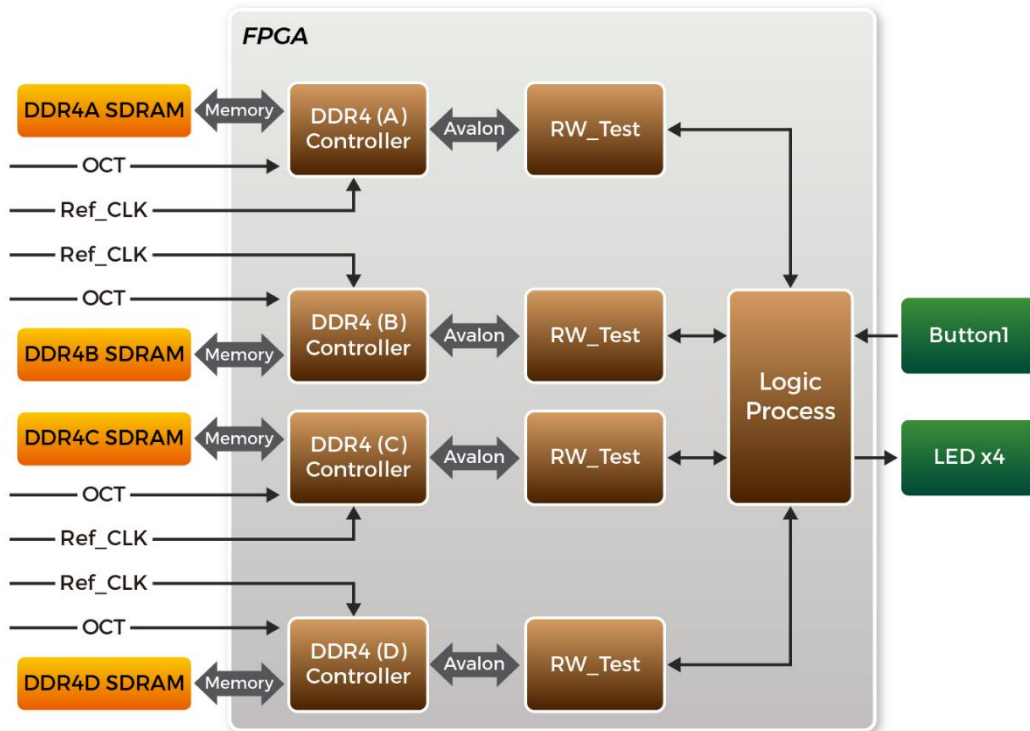

Figure 6-1 Block diagram of DDR4 SDRAM (4G) x4 demonstration

■ Stratix 10 External Memory Interfaces

To use Stratix 10 External Memory Interfaces controller for DDR4 SODIMM, please perform the two major steps below:

1. Create correct pin assignments for the DDR4 SODIMM.
2. Setup correct parameters in the dialog of the **Stratix 10 External Memory Interfaces**.

■ Design Tools

- Quartus Prime 18.1.1 Pro Edition

■ Demonstration Source Code

- Project Directory: Demonstration\RTL_DDR4_4GB_x4
- Bit Stream: DE10_Pro_golden_top.sof
- Demonstration Batch File

Demo Batch File Folder: RTL_DDR4_4GB_x4 \demo_batch

The demo batch file includes following files:

- Batch File: test.bat
- FPGA Configuration File: DE10_Pro_golden_top.sof

■ Demonstration Setup

- Make sure Quartus Prime Pro Edition is installed on the host PC.
- Connect the DE10-Pro board to the host PC via the USB cable. Install the USB-Blaster II driver if necessary.
- Power on the DE10-Pro board.
- Execute the demo batch file “test.bat” under the batch file folder \RTL_DDR4_4GB_x4\demo_batch.
- Press **BUTTON1** to start DDR4 write & loopback verify process. It will take about one second to perform the test. While testing, the LED will blink. When LED stop blinking it means the test process is done. In this case, if the LED light, it means the test result is passed. If the LED is no light, it means the test result is failed. The LED0 represents the test result for the DDR4 on the SODIMM Socket A, the LED1 represents the test result for the DDR4 on the SODIMM Socket B, and so on.
- Press **BUTTON1** again to regenerate the test control signals for a repeat test.

6.2 DDR4 SDRAM Test by Nios II

Many applications use a high performance RAM, such as a DDR4 SDRAM, to provide temporary storage. In this demonstration hardware and software designs are provided

to illustrate how to perform DDR4 memory access in the **Platform Designer** (formerly Qsys). We describe how the memory controller **Stratix 10 External Memory Interfaces** is used to access the four DDR4-Sodimm's on the FPGA board, and how the Nios II processor is used to read and write the SDRAM for hardware verification. The DDR4 SDRAM controller handles the complex aspects of using the DDR4 SDRAM by initializing the memory devices, managing the SDRAM banks, and keeping the devices refreshed at the appropriate intervals.

■ System Block Diagram

Figure 6-2 shows the system block diagram of this demonstration. In the **Platform Designer** (formerly Qsys), one 50 MHz and four 300MHz clock source are used. The four 300 MHz clock source is provided by the two Si5340A (U20 and U28) clock generators on the board. Two Si5340A Config Controllers are used to configure the two Si5340A to generate the required clocks for the four DDR4 SODIMM. The 50MHz is used by the **Intel FPGA IOPLL** component to generate 200MHz for Nios Processor and On-Chip Memory. The four 300MHz clock are used as reference clocks for the DDR4 controllers. There are four DDR4 Controllers which are used in the demonstrations. Each controller is responsible for one DDR4-SODIMM. Each DDR4 controller is configured as a 4GB DDR4-1200Mhz controller. The Nios II processor is used to perform the memory test. The Nios II program is running in the On-Chip Memory. A PIO Controller is used to monitor buttons status which is used to trigger starting memory testing.

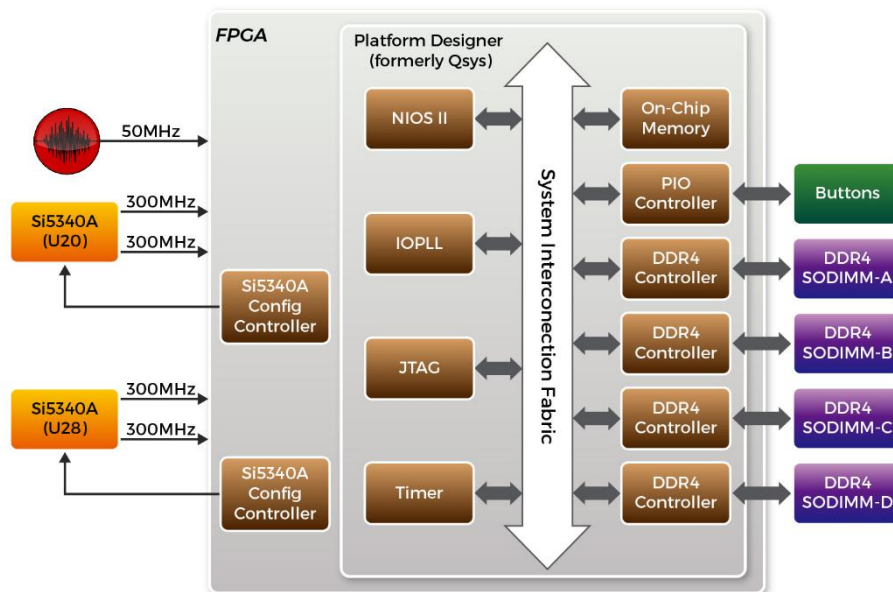

Figure 6-2 Block diagram of the DDR4 Basic Demonstration

The system flow is controlled by a Nios II program. First, the Nios II program writes test patterns into the whole 4GB of SDRAM. Then, it calls Nios II system function, `alt_dache_flush_all()`, to make sure all data has been written to SDRAM. Finally, it reads data from SDRAM for data verification. Maybe the process takes a long time, and there is a quick test. The Nios II program writes a constant pattern into the address line and data line and reads it back for verification. The program will show progress in Nios II terminal when writing/reading data to/from the SDRAM. When verification process is completed, the result is displayed in the Nios II terminal.

■ Design Tools

- Quartus Prime 18.1.1 Pro Edition

■ Demonstration Source Code

- Quartus Project directory: `Nios_DDR4_X4`
- Nios II Eclipse: `NIOS_DDR4_X4\software`

■ Nios II Project Compilation

Before you attempt to compile the reference design under Nios II Eclipse, make sure the project is cleaned first by clicking 'Clean' from the 'Project' menu of Nios II Eclipse.

■ Demonstration Batch File

Demo Batch File Folder: `NIOS_DDR4_X4\demo_batch`

The demo batch file includes following files:

- Batch File for USB-Blaster II: `test.bat`, `test.sh`
- FPGA Configure File: `DE10_Pro_golden_top.sof`
- Nios II Program: `MEM_TEST.elf`

■ Demonstration Setup

Please follow below procedures to set up the demonstrations.

- Make sure Quartus Prime and Nios II are installed on your PC.
- Make sure four DDR4 SODIMMs are installed on the FPGA board.
- Power on the FPGA board.
- Use a USB Cable to connect the PC and the FPGA board and install USB Blaster II driver if necessary.
- Execute the demo batch file “test.bat” under the folder “NIOS_DDR4_X4\demo_batch”.
- After the Nios II program is downloaded and executed successfully, a prompt message will be displayed in the nios2-terminal.
- For DDR4x4 test, please input key ‘0’ and press ‘Enter’ in the nios2-terminal as shown in **Figure 6-3**, **Figure 6-4** and **Figure 6-5**. The program will display progressing and result information. Press Button0~Button1 of the FPGA board to start SDRAM verify process, and press Button0 for continued test.
- For DDR4x4 quick test, please input key ‘1’ and press ‘Enter’ in the nios2-terminal as shown in **Figure 6-6**. The program will display progressing and result information. Press Button0~Button1 of the FPGA board to start SDRAM verify process, and press Button0 for continued test.

```
cs: /cygdrive/f/de10-pro/demo_batch_ddr4
===== DE10-Pro NIOS DDR4x4 Program =====
[0] DDR4x4 Test
[1] DDR4x4 Quick Test
Input your choice:0
===== DDR4x4 Test! Size=A: 4GB, B: 4GB, C: 4GB, D: 4GB =====

Press any BUTTON on the board to start test [BUTTON-0 for continued test]
====> DDR4x4 Testing, Iteration: 1
DDR4x4 Reset durations, 1.051 seconds
DDR4x4 Calibration Duration:1.054 seconds,
== DDR4-A Testing...
DDR4 address bank: 0GB ~ 1GB:
write...
10% 20% 30% 40% 50% 60% 70% 80% 90% 100%
read/verify...
10% 20% 30% 40% 50% 60% 70% 80% 90% 100%
DDR4 address bank: 1GB ~ 2GB:
write...
10% 20% 30% 40% 50% 60% 70% 80% 90% 100%
read/verify...
10% 20% 30% 40% 50% 60% 70% 80% 90% 100%
DDR4 address bank: 2GB ~ 3GB:
write...
10% 20% 30% 40% 50% 60% 70% 80% 90% 100%
read/verify...
10% 20% 30% 40% 50% 60% 70% 80% 90% 100%
DDR4 address bank: 3GB ~ 4GB:
write...
10% 20% 30% 40% 50% 60% 70% 80% 90% 100%
read/verify...
10% 20% 30% 40% 50% 60% 70% 80% 90% 100%
DDR4A test:Pass, 597 seconds
```

Figure 6-3 Progress and Result Information for the DDR4A Test

```

/cygdrive/f/de10-pro/demo_batch_ddr4
== DDR4-B Testing...
DDR4 address bank: 0GB ~ 1GB:
write...
10% 20% 30% 40% 50% 60% 70% 80% 90% 100%
read/verify...
10% 20% 30% 40% 50% 60% 70% 80% 90% 100%
DDR4 address bank: 1GB ~ 2GB:
write...
10% 20% 30% 40% 50% 60% 70% 80% 90% 100%
read/verify...
10% 20% 30% 40% 50% 60% 70% 80% 90% 100%
DDR4 address bank: 2GB ~ 3GB:
write...
10% 20% 30% 40% 50% 60% 70% 80% 90% 100%
read/verify...
10% 20% 30% 40% 50% 60% 70% 80% 90% 100%
DDR4B test:Pass, 597 seconds
== DDR4-C Testing...
DDR4 address bank: 0GB ~ 1GB:
write...
10% 20% 30% 40% 50% 60% 70% 80% 90% 100%
read/verify...
10% 20% 30% 40% 50% 60% 70% 80% 90% 100%
DDR4 address bank: 1GB ~ 2GB:
write...
10% 20% 30% 40% 50% 60% 70% 80% 90% 100%
read/verify...
10% 20% 30% 40% 50% 60% 70% 80% 90% 100%
DDR4 address bank: 2GB ~ 3GB:
write...
10% 20% 30% 40% 50% 60% 70% 80% 90% 100%
read/verify...
10% 20% 30% 40% 50% 60% 70% 80% 90% 100%
DDR4 address bank: 3GB ~ 4GB:
write...
10% 20% 30% 40% 50% 60% 70% 80% 90% 100%
read/verify...
10% 20% 30% 40% 50% 60% 70% 80% 90% 100%
DDR4C test:Pass, 597 seconds

```

Figure 6-4 Progress and Result Information for the DDR4B and DDR4C Test

```

/cygdrive/f/de10-pro/demo_batch_ddr4
== DDR4-D Testing...
DDR4 address bank: 0GB ~ 1GB:
write...
10% 20% 30% 40% 50% 60% 70% 80% 90% 100%
read/verify...
10% 20% 30% 40% 50% 60% 70% 80% 90% 100%
DDR4 address bank: 1GB ~ 2GB:
write...
10% 20% 30% 40% 50% 60% 70% 80% 90% 100%
read/verify...
10% 20% 30% 40% 50% 60% 70% 80% 90% 100%
DDR4 address bank: 2GB ~ 3GB:
write...
10% 20% 30% 40% 50% 60% 70% 80% 90% 100%
read/verify...
10% 20% 30% 40% 50% 60% 70% 80% 90% 100%
DDR4 address bank: 3GB ~ 4GB:
write...
10% 20% 30% 40% 50% 60% 70% 80% 90% 100%
read/verify...
10% 20% 30% 40% 50% 60% 70% 80% 90% 100%
DDR4D test:Pass, 596 seconds
DDR4x4 Test Test:PASS

```

Figure 6-5 Progress and Result Information for the DDR4D Demonstration

```
ca: /cygdrive/f/de10-pro/demo_batch_ddr4
===== DE10-Pro NIOS DDR4x4 Program =====
[0] DDR4x4 Test
[1] DDR4x4 Quick Test
Input your choice:1
===== DDR4x4 Test! Size=A: 4GB, B: 4GB, C: 4GB, D: 4GB =====

Press any BUTTON on the board to start test [BUTTON-0 for continued test]
====> DDR4x4 Testing, Iteration: 1
DDR4x4 Reset durations, 1.050 seconds
DDR4x4 Calibration Duration:0.558 seconds,
== DDR4-A Testing...
DDR4 address bank: 0GB ~ 1GB: PASS
DDR4 address bank: 1GB ~ 2GB: PASS
DDR4 address bank: 2GB ~ 3GB: PASS
DDR4 address bank: 3GB ~ 4GB: PASS
DDR4A test:Pass, 12 seconds
== DDR4-B Testing...
DDR4 address bank: 0GB ~ 1GB: PASS
DDR4 address bank: 1GB ~ 2GB: PASS
DDR4 address bank: 2GB ~ 3GB: PASS
DDR4 address bank: 3GB ~ 4GB: PASS
DDR4B test:Pass, 12 seconds
== DDR4-C Testing...
DDR4 address bank: 0GB ~ 1GB: PASS
DDR4 address bank: 1GB ~ 2GB: PASS
DDR4 address bank: 2GB ~ 3GB: PASS
DDR4 address bank: 3GB ~ 4GB: PASS
DDR4C test:Pass, 12 seconds
== DDR4-D Testing...
DDR4 address bank: 0GB ~ 1GB: PASS
DDR4 address bank: 1GB ~ 2GB: PASS
DDR4 address bank: 2GB ~ 3GB: PASS
DDR4 address bank: 3GB ~ 4GB: PASS
DDR4D test:Pass, 12 seconds
DDR4x4 Quick Test Test:PASS
```

Figure 6-6 Progress and Result Information for the DDR4A~DDR4D quick test

6.3 QDR II+ SRAM Test

QDR II/QDR II+ SRAM devices enable you to maximize memory bandwidth with separate read and write ports and low latency read/write operations. The memory architecture features separate read and write ports operating twice per clock cycle to deliver a total of four data transfers per cycle. The resulting performance increase is particularly valuable in bandwidth-intensive and low-latency applications.

This demonstration utilizes four QDR II+ SRAMs on the FPGA board. It describes how to use the memory controller **Stratix 10 External Memory Interfaces** to implement a memory test function for QDR-II+ memory.

■ Function Block Diagram

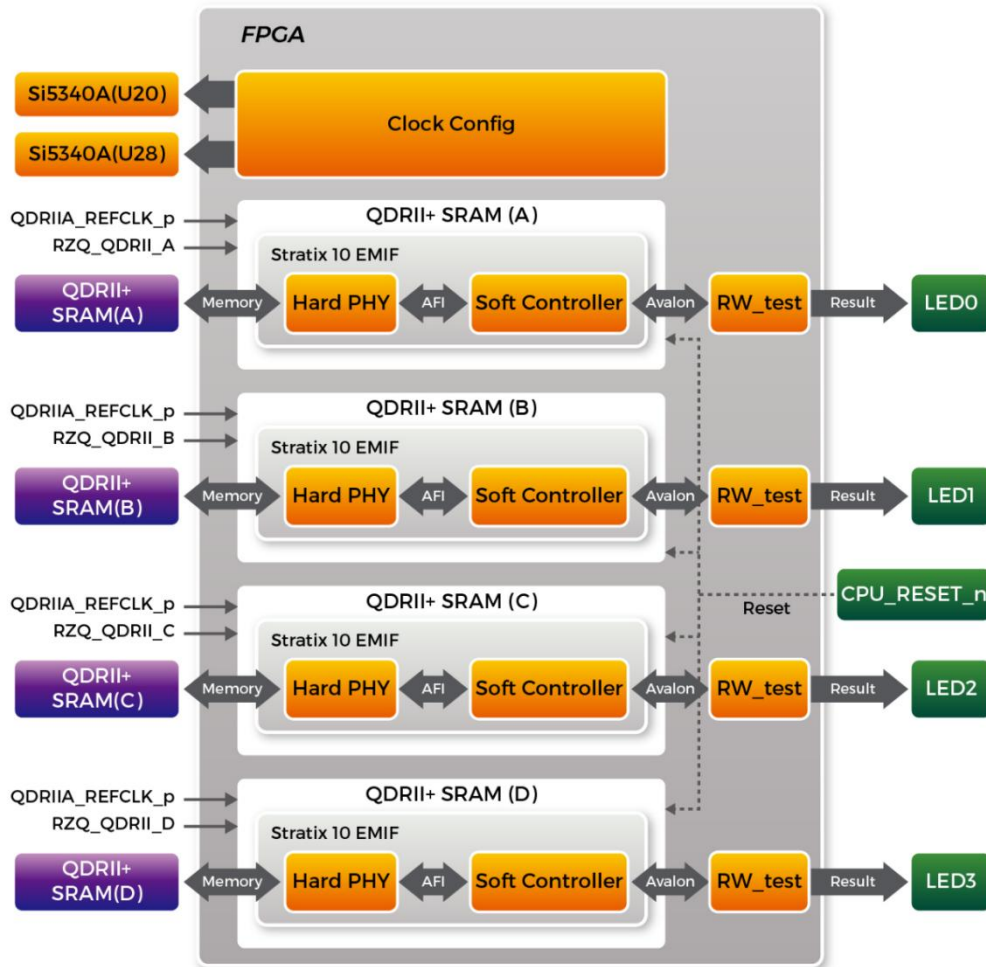

Figure 6-7 Function Block Diagram of the QDRII+ SRAM x4 Demonstration

Figure 6-7 shows the function block diagram of the demonstration. The four QDRII+ SRAM controllers are configured as a 144Mbit controller. The QDRII+ SRAM IP generates a 550MHz clock as memory clock and a half-rate system clock, 275MHz, for the controllers.

The four reference clock QDRIIA/B/C/D_REFCLK are generated from Si5340A which configured 275MHz for QDRII+ 550MHz by Clock Config module. QDRIIA/B/C/D_REFCLK has default frequency 300Mhz, so they must be configured first.

In this demonstration, each QDRII+ SRAM has its own PLL, DLL and OCT resources. For QDRII+ memory, the **Stratix 10 External Memory Interfaces** use a Hard PHY and a soft Controller. The Hard PHY is capable of performing key memory interface

functionality such as read/write leveling, FIFO buffering to lower latency and improve margin, timing calibration, and on-chip termination.

The Avalon bus read/write test (RW_test) modules read and write the entire memory space of each QDRII+ SRAM through the Avalon interface of each controller. In this project, the RW_test module will first write the entire memory and then compare the read back data with the regenerated data (the same sequence as the write data). Test control signals for four QDRII+ SRAMs will generate from CPU_RESET_n and four LEDs will indicate the test results of four QDRII+ SRAMs.

■ **Stratix 10 External Memory Interfaces for QDR II +**

To use **Stratix 10 External Memory Interfaces** for QDRII+ SRAM, users need to perform the following steps in order:

1. Create correct pin assignments for QDRII+.
2. Setup correct parameters in the dialog of **Stratix 10 External Memory Interfaces**.

■ **Design Tools**

- Quartus Prime 18.1.1 Pro Edition

■ **Demonstration Source Code**

- Project directory: QDRII_x4_Test_550MHz
- Bit stream used: DE10_Pro_golden_top.sof
- Demonstration Batch File

Demo Batch File Folder: QDRII_x4_Test_550MHz\demo_batch

The demo batch files include the followings:

- Batch file for USB-Blaster II: test.bat,
- FPGA configuration file: DE10_Pro_golden_top.sof

■ **Demonstration Setup**

- Make sure Quartus Prime Pro Edition is installed on your PC.

- Connect the USB cable to the FPGA board and host PC. Install the USB-Blaster II driver if necessary.
- Power on the FPGA Board.
- Execute the demo batch file “test.bat” under the batch file folder, QDRII_x4_Test_550MHz\demo_batch.
- Press CPU_RESET_n of the FPGA board to start the verification process. When CPU_RESET_n is held down, all the LEDs will be turned off. All LEDs should turn back on to indicate test passes upon the release of CPU_RESET_n.
- If any LED is not lit up after releasing CPU_RESET_n, it indicates the corresponding QDRII+ SRAM test has failed. **Table 6-1** lists the matchup for the four LEDs.
- Press CPU_RESET_n again to regenerate the test control signals for a repeat test.

Table 6-1 LED Indicators

NAME	Description
LED0	QDRII+ SRAM(A) test result
LED1	QDRII+ SRAM(B) test result
LED2	QDRII+ SRAM(C) test result
LED3	QDRII+ SRAM(D) test result

Chapter 7

PCI Express Reference

Design for Windows

PCI Express is commonly used in consumer, server, and industrial applications, to link motherboard-mounted peripherals. From this demonstration, it will show how the PC Windows and FPGA communicate with each other through the PCI Express interface. Stratix 10 Hard IP for PCI Express with Avalon-MM DMA IP is used in this demonstration. For detail about this IP, please refer to Altera document [ug_s10_pcie_avmm.pdf](#).

7.1 PCI Express System Infrastructure

Figure 7-1 shows the infrastructure of the PCI Express System in this demonstration. It consists of two primary components: FPGA System and PC System. The FPGA System is developed based on Stratix 10 Hard IP for PCI Express with Avalon-MM DMA. The application software on the PC side is developed by Terasic based on Altera's PCIe kernel mode driver.

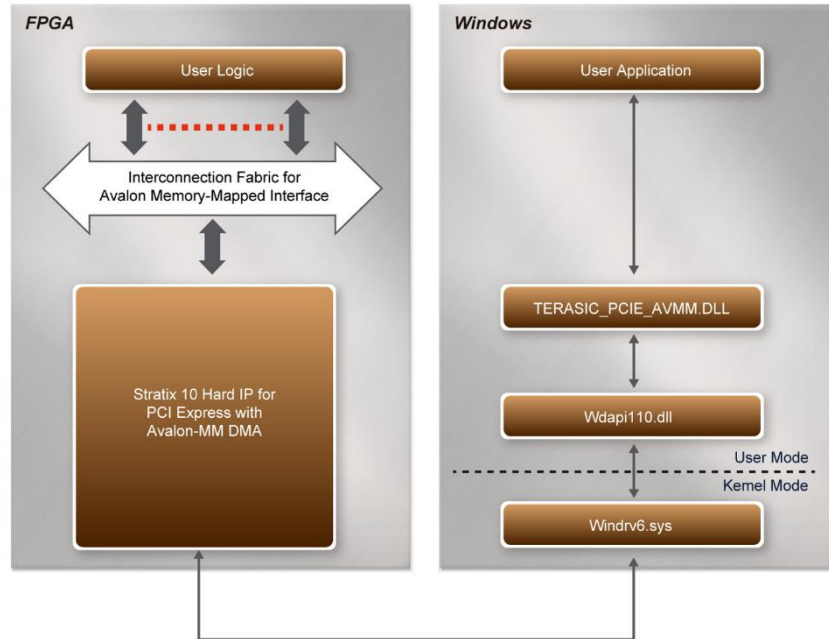

Figure 7-1 Infrastructure of PCI Express System

7.2 PC PCI Express Software SDK

The FPGA System CD contains a PC Windows based SDK to allow users to develop their 64-bit software application on 64-bits Windows 7 or Window XP. The SDK is located in the "CDROM\Demonstrations\PCIe_SW_KIT\Windows" folder which includes:

- PCI Express Driver
- PCI Express Library
- PCI Express Examples

The kernel mode driver assumes the PCIe vendor ID (VID) is 0x1172 and the device ID (DID) is 0xE003. If different VID and DID are used in the design, users need to modify the PCIe vendor ID (VID) and device ID (DID) in the driver INF file accordingly.

The PCI Express Library is implemented as a single DLL named TERASIC_PCIE_AVMM.DLL. This file is a 64-bit DLL. When the DLL is exported to the software API, users can easily communicate with the FPGA. The library provides the following functions:

- Basic data read and write
- Data read and write by DMA

For high performance data transmission, Altera AVMM DMA is required as the read and write operations, which are specified under the hardware design on the FPGA.

7.3 PCI Express Software Stack

Figure 7-2 shows the software stack for the PCI Express application software on 64-bit Windows. The PCIe library module `TERASIC_PCIE_AVMM.dll` provides DMA and direct I/O access allowing user application program to communicate with FPGA. Users can develop their applications based on this DLL. The `altera_pcie_win_driver.sys` kernel driver is provided by Altera.

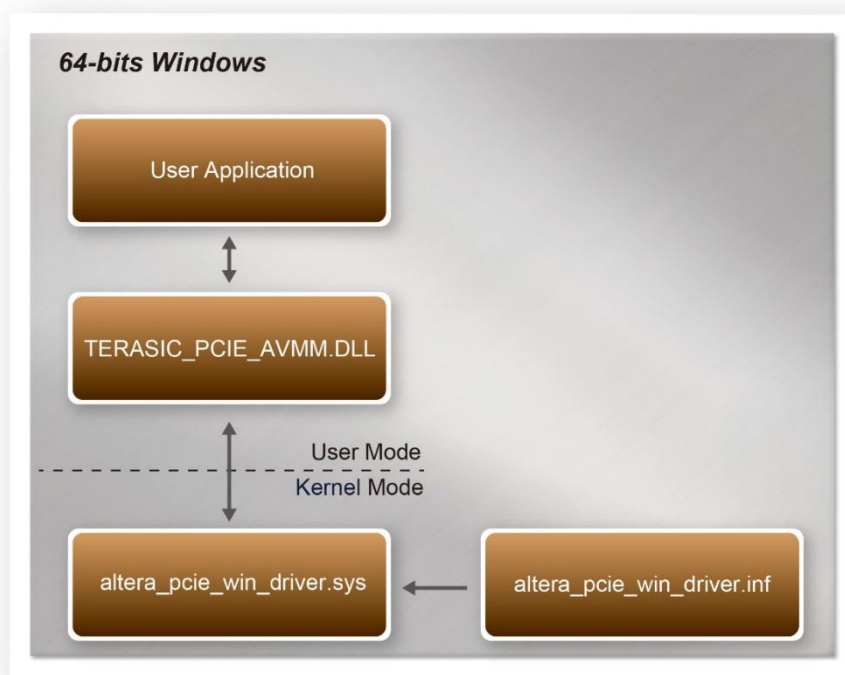

Figure 7-2 PCI Express Software Stack

■ Install PCI Express Driver on Windows

The PCIe driver is located in the folder:

"CDROM\Demonstrations\PCIe_SW_KIT\Windows\PCIe_Driver"

The folder includes the following four files:

- Altera_pcie_win_driver.cat
- Altera_pcie_win_driver.inf
- Altera_pcie_win_driver.sys
- WdfCoinstaller01011.dll

To install the PCI Express driver, please execute the steps below:

1. Install the DE10-Pro on the PCIe slot of the host PC
2. Make sure the Altera Programmer and USB-Blaster II driver are installed
3. Execute test.bat in "CDROM\Demonstrations\PCIe_Fundamental\demo_batch" to configure the FPGA
4. Restart windows operation system
5. Click the Control Panel menu from Windows Start menu. Click the Hardware and Sound item before clicking the Device Manager to launch the Device Manager dialog. There will be a PCI Device item in the dialog, as shown in **Figure 7-3**. Move the mouse cursor to the PCI Device item and right click it to select the Updated Driver Software... items.

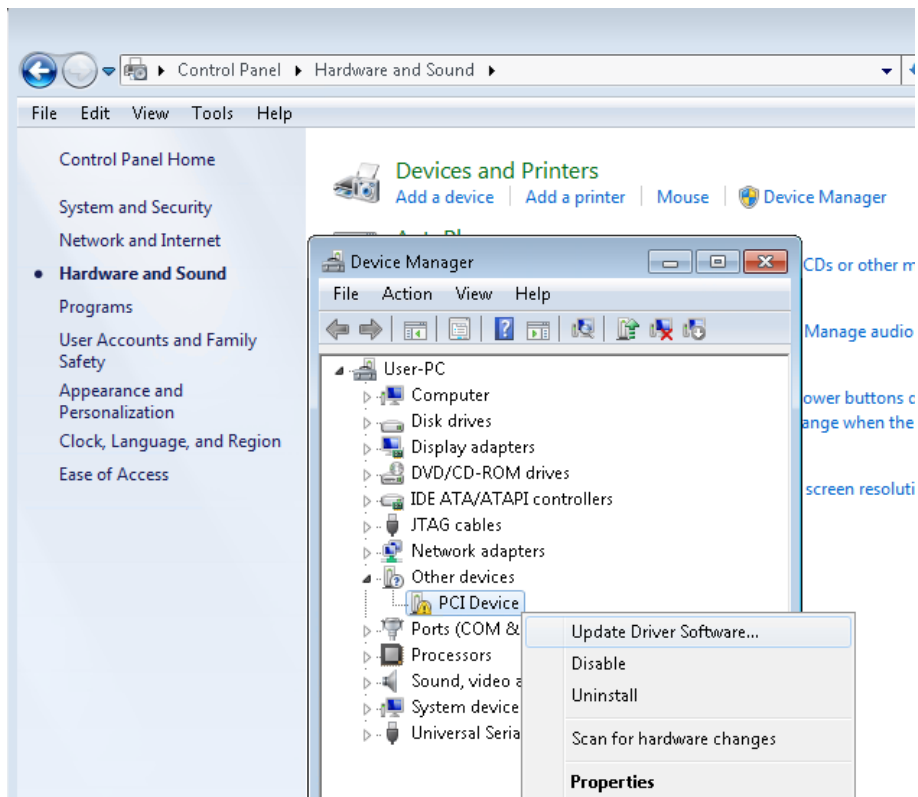

Figure 7-3 Screenshot of launching Update Driver Software... dialog

6. In the **How do you want to search for the driver software** dialog, click **Browse my computer for driver software** item, as shown in **Figure 7-4**

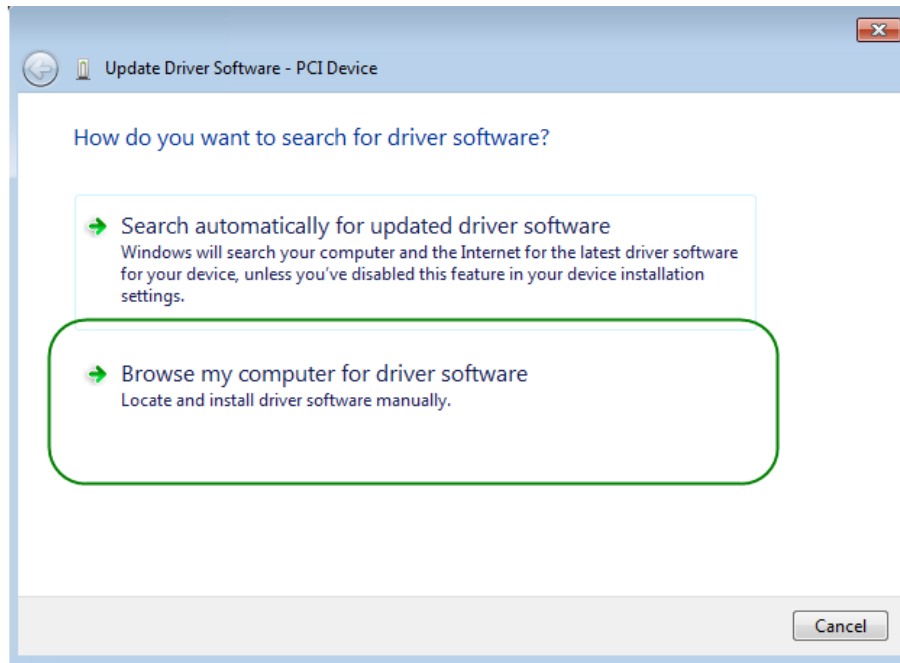

Figure 7-4 Dialog of Browse my computer for the driver software

7. In the **Browse for driver software on your computer** dialog, click the **Browse** button to specify the folder where `altera_pcie_din_driver.inf` is located, as shown in **Figure 7-5**. Click the **Next** button.

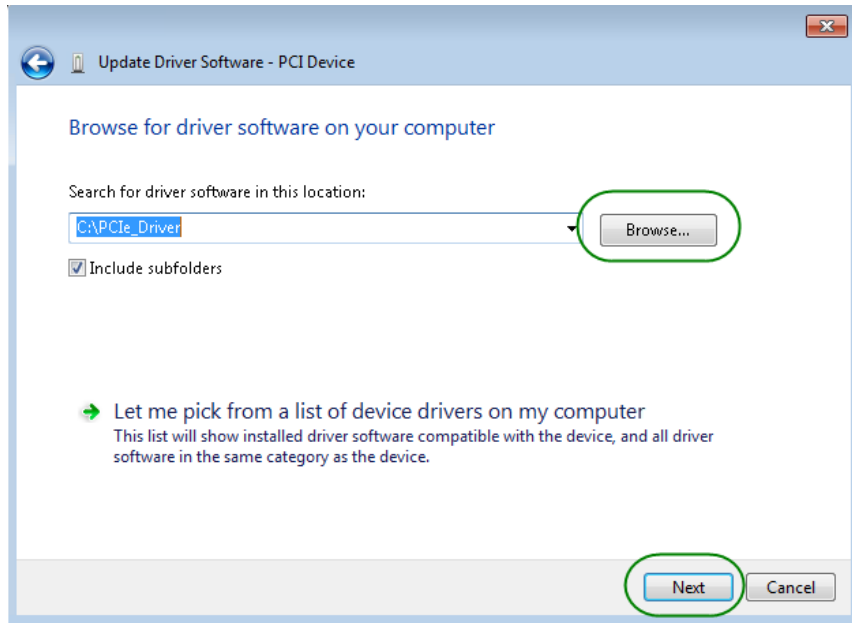

Figure 7-5 Browse for the driver software on your computer

8. When the **Windows Security** dialog appears, as shown **Figure 7-6**, click the **Install** button.

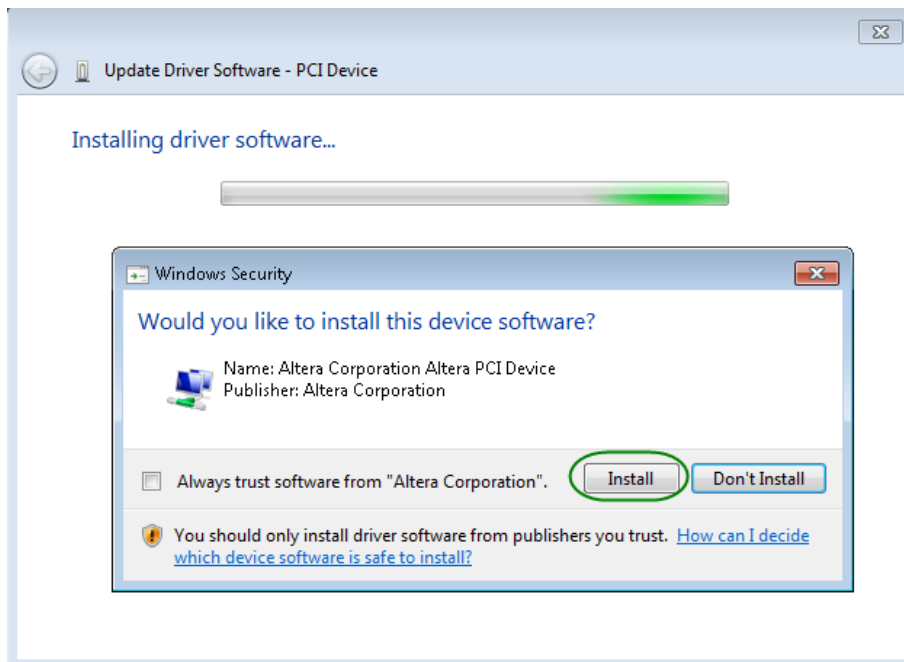

Figure 7-6 Click Install in the dialog of Windows Security

9. When the driver is installed successfully, the successfully dialog will appear, as shown in **Figure 7-7**. Click the **Close** button.

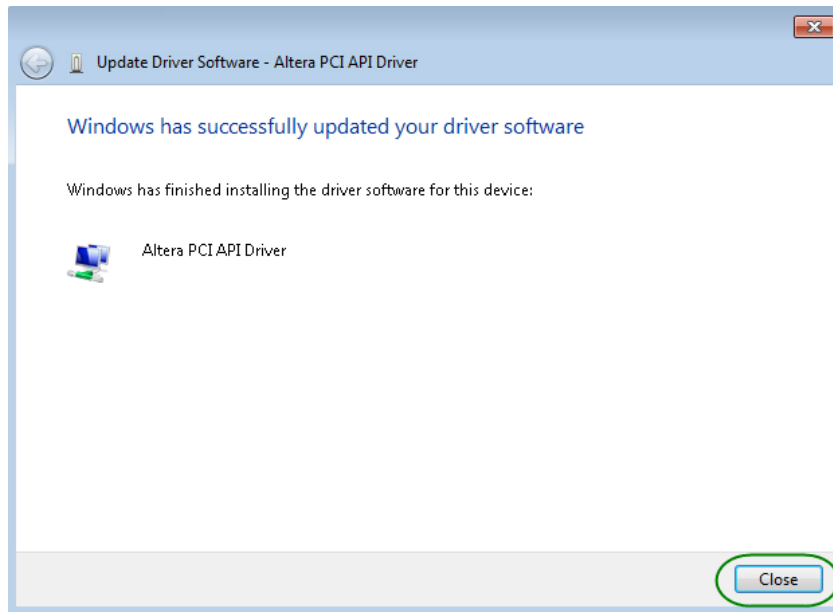

Figure 7-7 Click Close when the installation of the Altera PCI API Driver is complete

10. Once the driver is successfully installed, users can see the **Altera PCI API Driver** under the device manager window, as shown in **Figure 7-8**.

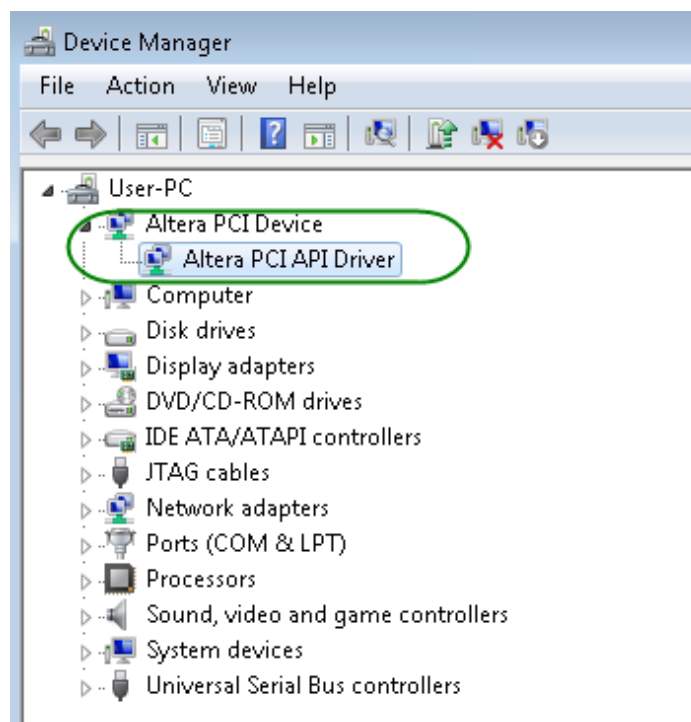

Figure 7-8 Altera PCI API Driver in Device Manager

■ Create a Software Application

All the files needed to create a PCIe software application are located in the directory CDRROM\demonstration\PCIe_SW_KIT\Windows\PCIe_Library. It includes the following files:

- TERASIC_PCIE_AVMM.h
- TERASIC_PCIE_AVMM.DLL (64-bit DLL)

Below lists the procedures to use the SDK files in users' C/C++ project :

1. Create a 64-bit C/C++ project.
2. Include TERASIC_PCIE_AVMM.h in the C/C++ project.
3. Copy TERASIC_PCIE_AVMM.DLL to the folder where the project.exe is located.
4. Dynamically load TERASIC_PCIE_AVMM.DLL in C/C++ program. To load the DLL, please refer to the PCIe fundamental example below.
5. Call the SDK API to implement the desired application.

Users can easily communicate with the FPGA through the PCIe bus through the TERASIC_PCIE_AVMM.DLL API. The details of API are described below:

7.4 PCI Express Library API

Below shows the exported API in the TERASIC_PCIE_AVMM.DLL. The API prototype is defined in the TERASIC_PCIE_AVMM.h.

Note: the Linux library terasic_pcie_qsys.so also use the same API and header file.

■ PCIE_Open

Function:

Open a specified PCIe card with vendor ID, device ID, and matched card index.

Prototype:

```
PCIE_HANDLE PCIE_Open(  
    uint8_t wVendorID,  
    uint8_t wDeviceID,  
    uint8_t wCardIndex);
```

Parameters:

wVendorID:

Specify the desired vendor ID. A zero value means to ignore the vendor ID.

wDeviceID:

Specify the desired device ID. A zero value means to ignore the device ID.

wCardIndex:

Specify the matched card index, a zero based index, based on the matched vendor ID and device ID.

Return Value:

Return a handle to presents specified PCIe card. A positive value is return if the PCIe card is opened successfully. A value zero means failed to connect the target PCIe card.

This handle value is used as a parameter for other functions, e.g. PCIE_Read32.

Users need to call PCIE_Close to release handle once the handle is no longer used.

■ PCIE_Close**Function:**

Close a handle associated to the PCIe card.

Prototype:

```
void PCIE_Close(  
    PCIE_HANDLE hPCIE);
```

Parameters:

hPCIE:

A PCIe handle return by PCIE_Open function.

Return Value:

None.

■ PCIE_Read32**Function:**

Read a 32-bit data from the FPGA board.

Prototype:

```
bool PCIE_Read32(  
    PCIE_HANDLE hPCIE,  
    PCIE_BAR PcieBar,  
    PCIE_ADDRESS PcieAddress,
```

uint32_t *pdwData);
Parameters: hPCIE: A PCIe handle return by PCIE_Open function. PcieBar: Specify the target BAR. PcieAddress: Specify the target address in FPGA. pdwData: A buffer to retrieve the 32-bit data.
Return Value: Return true if read data is successful; otherwise false is returned.

■ PCIE_Write32

Function: Write a 32-bit data to the FPGA Board.
Prototype: <pre>bool PCIE_Write32(PCIE_HANDLE hPCIE, PCIE_BAR PcieBar, PCIE_ADDRESS PcieAddress, uint32_t dwData);</pre>
Parameters: hPCIE: A PCIe handle return by PCIE_Open function. PcieBar: Specify the target BAR. PcieAddress: Specify the target address in FPGA. dwData: Specify a 32-bit data which will be written to FPGA board.
Return Value: Return true if write data is successful; otherwise false is returned.

■ PCIE_Read8

Function:
Read an 8-bit data from the FPGA board.
Prototype:
<pre>bool PCIE_Read8(PCIE_HANDLE hPCIE, PCIE_BAR PcieBar, PCIE_ADDRESS PcieAddress, uint8_t *pByte);</pre>
Parameters:
<p>hPCIE: A PCIe handle return by PCIE_Open function.</p> <p>PcieBar: Specify the target BAR.</p> <p>PcieAddress: Specify the target address in FPGA.</p> <p>pByte: A buffer to retrieve the 8-bit data.</p>
Return Value:
Return true if read data is successful; otherwise false is returned.

■ PCIE_Write8

Function:
Write an 8-bit data to the FPGA Board.
Prototype:
<pre>bool PCIE_Write8(PCIE_HANDLE hPCIE, PCIE_BAR PcieBar, PCIE_ADDRESS PcieAddress, uint8_t Byte);</pre>
Parameters:
<p>hPCIE: A PCIe handle return by PCIE_Open function.</p> <p>PcieBar:</p>

<p>Specify the target BAR.</p> <p>PcieAddress: Specify the target address in FPGA.</p> <p>Byte: Specify an 8-bit data which will be written to FPGA board.</p>
<p>Return Value: Return true if write data is successful; otherwise false is returned.</p>

■ PCIE_DmaRead

<p>Function: Read data from the memory-mapped memory of FPGA board in DMA. Maximal read size is (4GB-1) bytes.</p>
<p>Prototype:</p> <pre>bool PCIE_DmaRead(PCIE_HANDLE hPCIE, PCIE_LOCAL_ADDRESS LocalAddress, void *pBuffer, uint32_t dwBufSize);</pre>
<p>Parameters:</p> <p>hPCIE: A PCIe handle return by PCIE_Open function.</p> <p>LocalAddress: Specify the target memory-mapped address in FPGA.</p> <p>pBuffer: A pointer to a memory buffer to retrieved the data from FPGA. The size of buffer should be equal or larger the dwBufSize.</p> <p>dwBufSize: Specify the byte number of data retrieved from FPGA.</p>
<p>Return Value: Return true if read data is successful; otherwise false is returned.</p>

■ PCIE_DmaWrite

<p>Function: Write data to the memory-mapped memory of FPGA board in DMA.</p>
--

Prototype:

```
bool PCIE_DmaWrite(  
    PCIE_HANDLE hPCIE,  
    PCIE_LOCAL_ADDRESS LocalAddress,  
    void *pData,  
    uint32_t dwDataSize  
);
```

Parameters:**hPCIE:**

A PCIe handle return by PCIE_Open function.

LocalAddress:

Specify the target memory mapped address in FPGA.

pData:

A pointer to a memory buffer to store the data which will be written to FPGA.

dwDataSize:

Specify the byte number of data which will be written to FPGA.

Return Value:

Return **true** if write data is successful; otherwise **false** is returned.

■ PCIE_ConfigRead32

Function:

Read PCIe Configuration Table. Read a 32-bit data by given a byte offset.

Prototype:

```
bool PCIE_ConfigRead32 (  
    PCIE_HANDLE hPCIE,  
    uint32_t Offset,  
    uint32_t *pdwData  
);
```

Parameters:**hPCIE:**

A PCIe handle return by PCIE_Open function.

Offset:

Specify the target byte of offset in PCIe configuration table.

pdwData:

A 4-bytes buffer to retrieve the 32-bit data.

Return Value:

Return **true** if read data is successful; otherwise **false** is returned.

7.5 PCIe Reference Design -Fundamental

The application reference design shows how to implement fundamental control and data transfer in DMA. In the design, basic I/O is used to control the BUTTON and LED on the FPGA board. High-speed data transfer is performed by the DMA.

■ Demonstration Files Location

The demo file is located in the batch folder:

CDROM\Demonstrations\PCIe_Fundamental\demo_batch

The folder includes following files:

- FPGA Configuration File: DE10_Pro.sof
- Download Batch file: test.bat
- Windows Application Software folder: windows_app, includes
 - ✧ PCIE_FUNDAMENTAL.exe
 - ✧ TERASIC_PCIE_AVMM.dll

■ Demonstration Setup

1. Install the FPGA board on your PC as shown in **Figure 7-9**.



Figure 7-9 FPGA board installation on PC

2. Configure FPGA with DE10_Pro.sof by executing the test.bat.
3. Install the PCIe driver if necessary. The driver is located in the folder:
CDROM\Demonstration\PCIe_SW_KIT\Windows\PCIe_Driver.
4. Restart Windows
5. Make sure that Windows has detected the FPGA Board by checking the Windows Device Manager as shown in **Figure 7-10**.

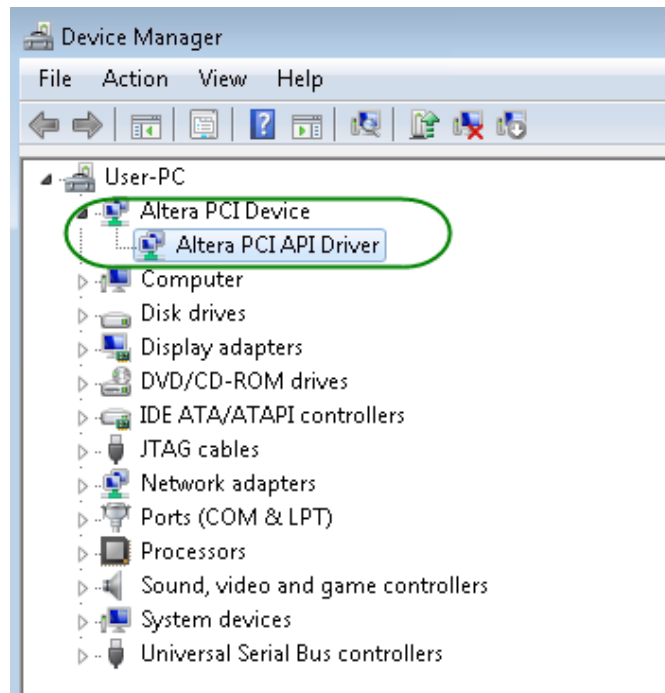

Figure 7-10 Screenshot for PCIe Driver

6. Go to windows_app folder, execute PCIE_FUNDMENTAL.exe. A menu will appear as shown in **Figure 7-11**.

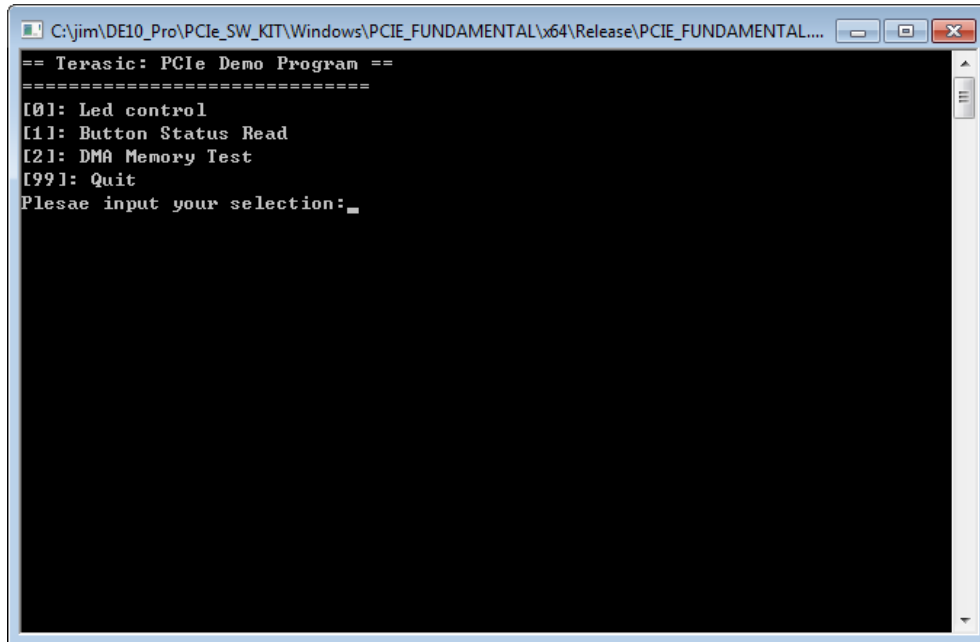

Figure 7-11 Screenshot of Program Menu

7. Type 0 followed by a ENTER key to select Led Control item, then input 15 (hex 0x0f) will make all LEDs on as shown in **Figure 7-12**. If input 0 (hex 0x00), all LEDs will be turned off.

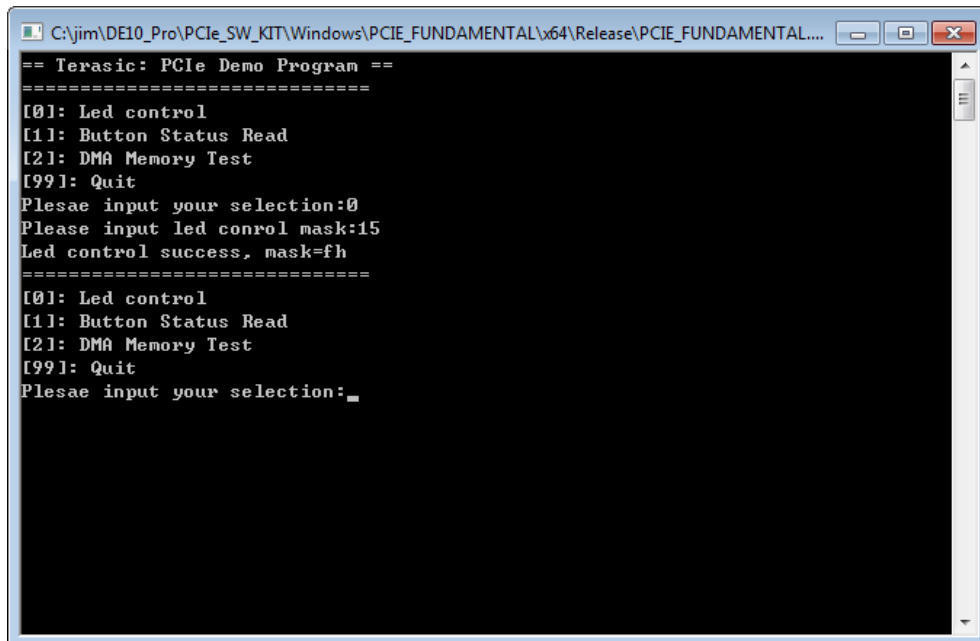
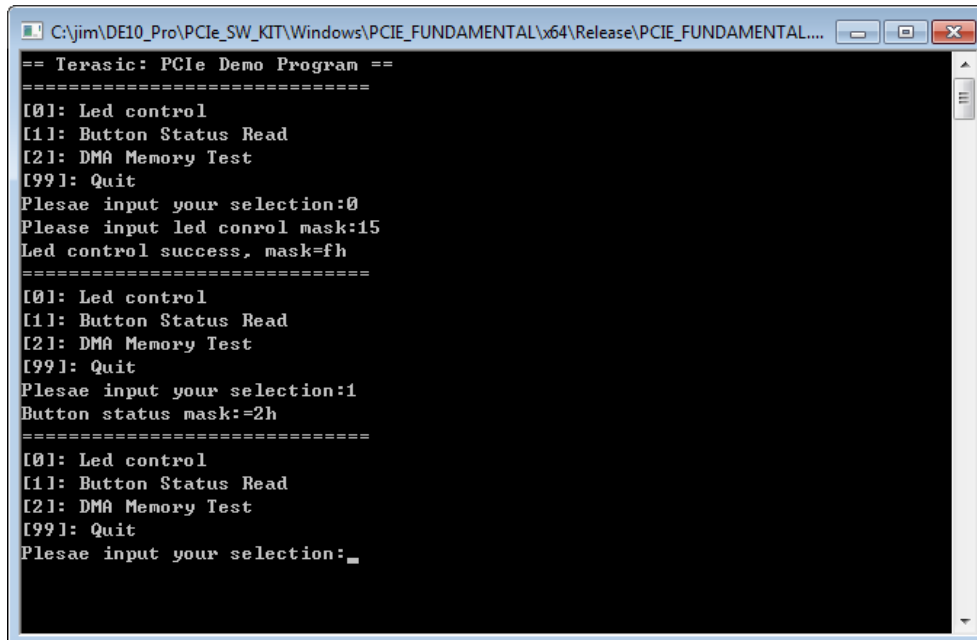

Figure 7-12 Screenshot of LED Control

8. Type 1 followed by an ENTER key to select Button Status Read item. The button status will be reported as shown in [Figure 7-13](#).



```
C:\jim\DE10_Pro\PCIE_SW_KIT\Windows\PCIE_FUNDAMENTAL\64\Release\PCIE_FUNDAMENTAL...
== Terasic: PCIe Demo Program ==
=====
[0]: Led control
[1]: Button Status Read
[2]: DMA Memory Test
[99]: Quit
Plesae input your selection:0
Please input led control mask:15
Led control success, mask=fh
=====
[0]: Led control
[1]: Button Status Read
[2]: DMA Memory Test
[99]: Quit
Plesae input your selection:1
Button status mask:=2h
=====
[0]: Led control
[1]: Button Status Read
[2]: DMA Memory Test
[99]: Quit
Plesae input your selection:_
```

Figure 7-13 Screenshot of Button Status Report

9. Type 2 followed by an ENTER key to select the DMA Testing item. The DMA test result will be reported as shown in [Figure 7-14](#).

```

C:\jim\DE10_Pro\PCIE_SW_KIT\Windows\PCIE_FUNDAMENTAL\x64\Release\PCIE_FUNDAMENTAL...
[2]: DMA Memory Test
[99]: Quit
Plesae input your selection:0
Please input led control mask:15
Led control success, mask=fh
=====
[0]: Led control
[1]: Button Status Read
[2]: DMA Memory Test
[99]: Quit
Plesae input your selection:1
Button status mask:=2h
=====
[0]: Led control
[1]: Button Status Read
[2]: DMA Memory Test
[99]: Quit
Plesae input your selection:2
DMA-Memory (Size = 524288 bytes) pass
=====
[0]: Led control
[1]: Button Status Read
[2]: DMA Memory Test
[99]: Quit
Plesae input your selection:_

```

Figure 7-14 Screenshot of DMA Memory Test Result

10. Type 99 followed by an ENTER key to exit this test program

■ Development Tools

- Quartus Prime 18.1.1 Pro Edition
- Visual C++ 2012

■ Demonstration Source Code Location

- Quartus Project: Demonstrations\PCIE_Fundamental
- C++ Project: Demonstrations\PCIE_SW_KIT\Windows\PCIE_FUNDAMENTAL

■ FPGA Application Design

Figure 7-15 shows the system block diagram in the FPGA system. In the **Platform Designer** (formerly Qsys), the PIO controller is used to control the LED and monitor the Button Status, and the On-Chip memory is used for performing DMA testing. The PIO controllers and the On-Chip memory are connected to the PCI Express Hard IP controller through the Memory-Mapped Interface.

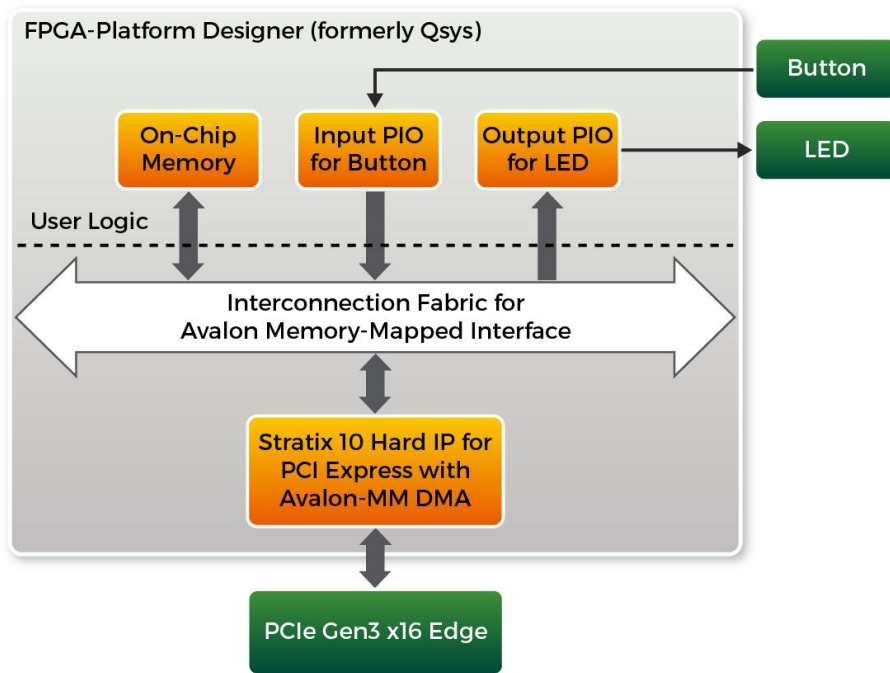

Figure 7-15 Hardware block diagram of the PCIe reference design

■ Windows Based Application Software Design

The application software project is built by Visual C++ 2012. The project includes the following major files:

Name	Description
PCIE_FUNDAMENTAL.cpp	Main program
PCIE.c	Implement dynamically load for
PCIE.h	TERASIC_PCIE_AVMM.DLL
TERASIC_PCIE_AVMM.h	SDK library file, defines constant and data structure

The main program PCIE_FUNDAMENTAL.cpp includes the header file "PCIE.h" and defines the controller address according to the FPGA design.

```

#include "PCIE.h"

#define DEMO_PCIE_USER_BAR          PCIE_BAR4
#define DEMO_PCIE_IO_LED_ADDR       0x4000010
#define DEMO_PCIE_IO_BUTTON_ADDR   0x4000020
#define DEMO_PCIE_MEM_ADDR          0x00000000

#define MEM_SIZE                     (512*1024) //512KB

```

The base address of BUTTON and LED controllers are 0x4000010 and 0x4000020 based on the PCIE_BAR4, respectively. The on-chip memory base address is 0x00000000 relative to the DMA controller.

Before accessing the FPGA through PCI Express, the application first calls the PCIE_Load to dynamically load the Terasic_PCIE_AVMM.DLL. Then, it calls PCIE_Open to open the PCI Express driver. The constant DEFAULT_PCIE_VID and DEFAULT_PCIE_DID used in the PCIE_Open are defined in Terasic_PCIE_AVMM.h. If developers change the Vendor ID and Device ID and PCI Express IP, they also need to change the ID value defined in Terasic_PCIE_AVMM.h. If the return value of PCIE_Open is zero, it means the driver cannot be accessed successfully. In this case, please make sure:

- The FPGA is configured with the associated bit-stream file and the host is rebooted.
- The PCI express driver is loaded successfully.

The LED control is implemented by calling **PCIE_Write32** API, as shown below:

```
bPass = PCIE_Write32(hPCIE, DEMO_PCIE_USER_BAR, DEMO_PCIE_IO_LED_ADDR, (uint32_t) Mask);
```

The button status query is implemented by calling the **PCIE_Read32** API, as shown below:

```
PCIE_Read32(hPCIE, DEMO_PCIE_USER_BAR, DEMO_PCIE_IO_BUTTON_ADDR, &Status);
```

The memory-mapped memory read and write test is implemented by **PCIE_DmaWrite** and **PCIE_DmaRead** API, as shown below:

```
PCIE_DmaWrite(hPCIE, LocalAddr, pWrite, nTestSize);  
PCIE_DmaRead(hPCIE, LocalAddr, pRead, nTestSize);
```

7.6 PCIe Reference Design - DDR4

The application reference design shows how to add the DDR4 Memory Controllers for the DDR4-A SODIMM, DDR4-B SODIMM, DDR4-C SODIMM and DDR4-D SODIMM into the PCIe Quartus project based on the PCIe_Fundamental Quartus project and perform 4GB data DMA for both SODIMM. Also, this demo shows how to call “PCIE_ConfigRead32” API to check PCIe link status.

■ Demonstration Files Location

The demo file is located in the batch folder:

CDROM\Demonstrations\PCIe_DDR4\demo_batch

The folder includes following files:

- FPGA Configuration File: DE10_Pro.sof
- Download Batch file: test.bat
- Windows Application Software folder: windows_app, includes
 - ✧ PCIE_DDR4.exe
 - ✧ TERASIC_PCIE_AVMM.dll

■ Demonstration Setup

1. Install four pieces of DDR4 2400 4GB SODIMM on the FPGA board.
2. Install the FPGA board on your PC.
3. Configure the FPGA with the DE10_Pro sof by executing the test.bat.
4. Install the PCIe driver if necessary.
5. Restart Windows
6. Make sure that Windows has detected the FPGA Board by checking the Windows Control panel.
7. Go to windows_app folder, execute PCIE_DDR4.exe. A menu will appear as shown in **Figure 7-16**.

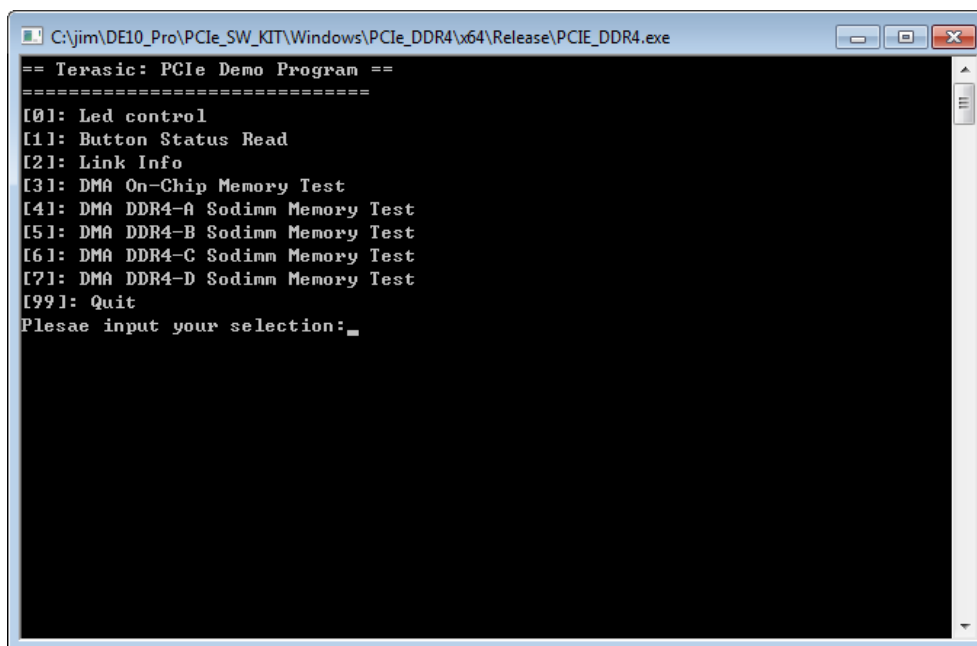

Figure 7-16 Screenshot of Program Menu

8. Type 2 followed by the ENTER key to select the Link Info item. The PCIe link information will be shown as in **Figure 7-17**. Gen3 link speed and x8 link width are expected.

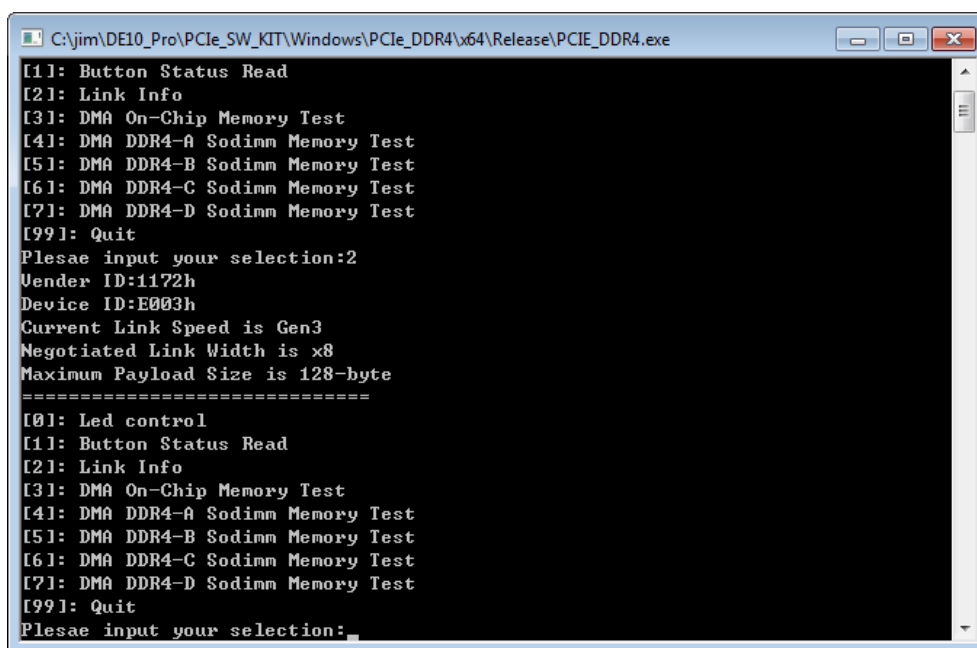

Figure 7-17 Screenshot of Link Info

9. Type 3 followed by the ENTER key to select DMA On-Chip Memory Test item. The DMA write and read test result will be reported as shown in **Figure 7-18**.

```

C:\jim\DE10_Pro\PCIE_SW_KIT\Windows\PCIE_DDR4\x64\Release\PCIE_DDR4.exe
[2]: Link Info
[3]: DMA On-Chip Memory Test
[4]: DMA DDR4-A Sodimm Memory Test
[5]: DMA DDR4-B Sodimm Memory Test
[6]: DMA DDR4-C Sodimm Memory Test
[7]: DMA DDR4-D Sodimm Memory Test
[99]: Quit
Plesae input your selection:3
DMA Memory Test, Address = 0x0, Size = 0x80000 Bytes...
Generate Test Pattern...
DMA Write...
DMA Read...
Readback Data Verify...
DMA-Memory Address = 0x0, Size = 0x80000 bytes pass
=====
[0]: Led control
[1]: Button Status Read
[2]: Link Info
[3]: DMA On-Chip Memory Test
[4]: DMA DDR4-A Sodimm Memory Test
[5]: DMA DDR4-B Sodimm Memory Test
[6]: DMA DDR4-C Sodimm Memory Test
[7]: DMA DDR4-D Sodimm Memory Test
[99]: Quit
Plesae input your selection:

```

Figure 7-18 Screenshot of On-Chip Memory DMA Test Result

10. Type 4 followed by the ENTER key to select the DMA DDR4-A SODIMM Memory Test item. The DMA write and read test result will be reported as shown in **Figure 7-19**.

```

C:\jim\DE10_Pro\PCIE_SW_KIT\Windows\PCIE_DDR4\x64\Release\PCIE_DDR4.exe
[4]: DMA DDR4-A Sodimm Memory Test
[5]: DMA DDR4-B Sodimm Memory Test
[6]: DMA DDR4-C Sodimm Memory Test
[7]: DMA DDR4-D Sodimm Memory Test
[99]: Quit
Plesae input your selection:4
DMA Memory Test, Address = 0x800000000, Size = 0x100000000 Bytes...
Generate Test Pattern...
DMA Write...
DMA Read...
Readback Data Verify...
DMA Read...
Readback Data Verify...
DMA-Memory Address = 0x800000000, Size = 0x100000000 bytes pass
=====
[0]: Led control
[1]: Button Status Read
[2]: Link Info
[3]: DMA On-Chip Memory Test
[4]: DMA DDR4-A Sodimm Memory Test
[5]: DMA DDR4-B Sodimm Memory Test
[6]: DMA DDR4-C Sodimm Memory Test
[7]: DMA DDR4-D Sodimm Memory Test
[99]: Quit
Plesae input your selection:

```

Figure 7-19 Screenshot of the DDR4-A SOSIMM Memory DMA Test Result

11. Type 5 followed by the ENTER key to select the DMA DDR4-B SODIMM Memory Test item. The DMA write and read test result will be reported as shown in **Figure 7-20**.

```
C:\jim\DE10_Pro\PCie_SW_KIT\Windows\PCie_DDR4\x64\Release\PCie_DDR4.exe
[4]: DMA DDR4-A Sodimm Memory Test
[5]: DMA DDR4-B Sodimm Memory Test
[6]: DMA DDR4-C Sodimm Memory Test
[7]: DMA DDR4-D Sodimm Memory Test
[99]: Quit
Plesae input your selection:5
DMA Memory Test, Address = 0xa00000000, Size = 0x100000000 Bytes...
Generate Test Pattern...
DMA Write...
DMA Read...
Readback Data Verify...
DMA Read...
Readback Data Verify...
DMA-Memory Address = 0xa00000000, Size = 0x100000000 bytes pass
=====
[0]: Led control
[1]: Button Status Read
[2]: Link Info
[3]: DMA On-Chip Memory Test
[4]: DMA DDR4-A Sodimm Memory Test
[5]: DMA DDR4-B Sodimm Memory Test
[6]: DMA DDR4-C Sodimm Memory Test
[7]: DMA DDR4-D Sodimm Memory Test
[99]: Quit
Plesae input your selection:█
```

Figure 7-20 Screenshot of the DDR4-B SOSIMM Memory DMA Test Result

12. Type 6 followed by an ENTER key to select DMA DDR4-C SODIMM Memory Test item. The DMA write and read test result will be reported as shown in **Figure 7-21**.

```
C:\jim\DE10_Pro\PCie_SW_KIT\Windows\PCie_DDR4\x64\Release\PCie_DDR4.exe
[4]: DMA DDR4-A Sodimm Memory Test
[5]: DMA DDR4-B Sodimm Memory Test
[6]: DMA DDR4-C Sodimm Memory Test
[7]: DMA DDR4-D Sodimm Memory Test
[99]: Quit
Plesae input your selection:6
DMA Memory Test, Address = 0xc00000000, Size = 0x100000000 Bytes...
Generate Test Pattern...
DMA Write...
DMA Read...
Readback Data Verify...
DMA Read...
Readback Data Verify...
DMA-Memory Address = 0xc00000000, Size = 0x100000000 bytes pass
=====
[0]: Led control
[1]: Button Status Read
[2]: Link Info
[3]: DMA On-Chip Memory Test
[4]: DMA DDR4-A Sodimm Memory Test
[5]: DMA DDR4-B Sodimm Memory Test
[6]: DMA DDR4-C Sodimm Memory Test
[7]: DMA DDR4-D Sodimm Memory Test
[99]: Quit
Plesae input your selection:█
```

Figure 7-21 Screenshot of the DDR4-C SOSIMM Memory DMA Test Result

13. Type 7 followed by the ENTER key to select the DMA DDR4-D SODIMM Memory Test item. The DMA write and read test result will be reported as shown in **Figure 7-22**.

```

C:\jim\DE10_Pro\PCIE_SW_KIT\Windows\PCIE_DDR4\x64\Release\PCIE_DDR4.exe
[4]: DMA DDR4-A Sodimm Memory Test
[5]: DMA DDR4-B Sodimm Memory Test
[6]: DMA DDR4-C Sodimm Memory Test
[7]: DMA DDR4-D Sodimm Memory Test
[99]: Quit
Plesae input your selection:7
DMA Memory Test, Address = 0xe0000000, Size = 0x10000000 Bytes...
Generate Test Pattern...
DMA Write...
DMA Read...
Readback Data Uerify...
DMA Read...
Readback Data Uerify...
DMA-Memory Address = 0xe0000000, Size = 0x10000000 bytes pass
=====
[0]: Led control
[1]: Button Status Read
[2]: Link Info
[3]: DMA On-Chip Memory Test
[4]: DMA DDR4-A Sodimm Memory Test
[5]: DMA DDR4-B Sodimm Memory Test
[6]: DMA DDR4-C Sodimm Memory Test
[7]: DMA DDR4-D Sodimm Memory Test
[99]: Quit
Plesae input your selection:

```

Figure 7-22 Screenshot of DDR4-D SODIMM Memory DMA Test Result

14. Type 99 followed by the ENTER key to exit this test program.

■ Development Tools

- Quartus Prime 18.1.1 Pro Edition
- Visual C++ 2012

■ Demonstration Source Code Location

- Quartus Project: Demonstrations\PCIE_DDR4
- Visual C++ Project: Demonstrations\PCIE_SW_KIT\Windows\PCIE_DDR4

■ FPGA Application Design

Figure 7-23 shows the system block diagram in the FPGA system. In the **Platform Designer** (formerly Qsys), the PIO controller is used to control the LED and monitor the Button Status, and the On-Chip memory is used for performing DMA testing. The PIO controllers and the On-Chip memory are connected to the PCI Express Hard IP controller through the Memory-Mapped Interface.

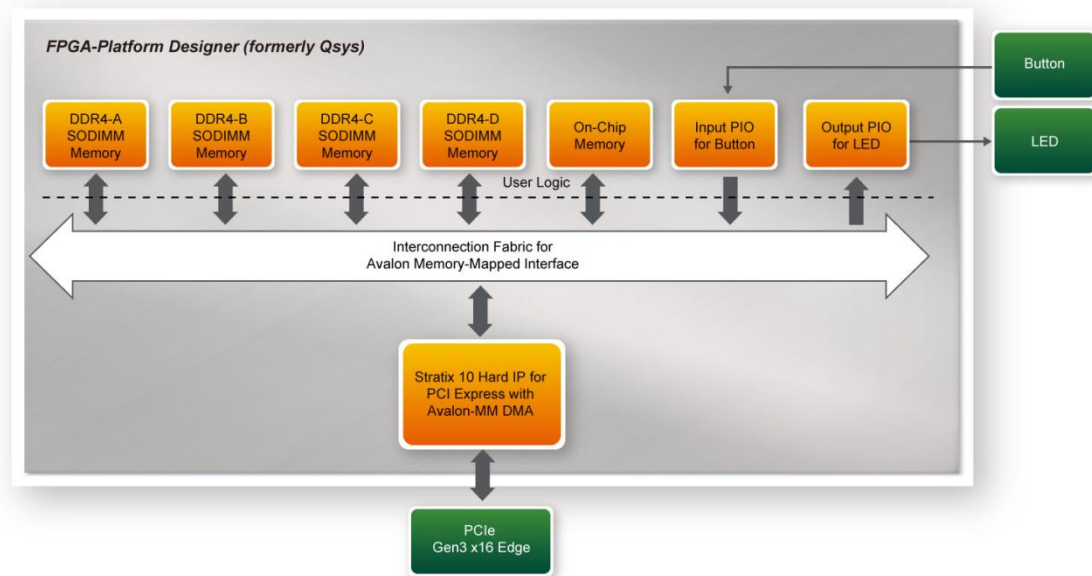

Figure 7-23 Hardware block diagram of the PCIe_DDR4 reference design

■ Windows Based Application Software Design

The application software project is built by Visual C++ 2012. The project includes the following major files:

Name	Description
PCIE_DDR4.cpp	Main program
PCIE.c	Implement dynamically load for TERAISC_PCIE_AVMM.DLL
PCIE.h	
TERASIC_PCIE_AVMM.h	SDK library file, defines constant and data structure

The main program PCIE_DDR4.cpp includes the header file "PCIE.h" and defines the controller address according to the FPGA design.

```

#define DEMO_PCIE_USER_BAR          PCIE_BAR4
#define DEMO_PCIE_IO_LED_ADDR      0x4000010
#define DEMO_PCIE_IO_BUTTON_ADDR   0x4000020
#define DEMO_PCIE_ONCHIP_MEM_ADDR  0x00000000
#define DEMO_PCIE_DDR4A_MEM_ADDR   0x80000000
#define DEMO_PCIE_DDR4B_MEM_ADDR   0xA0000000
#define DEMO_PCIE_DDR4C_MEM_ADDR   0xC0000000
#define DEMO_PCIE_DDR4D_MEM_ADDR   0xE0000000

#define ONCHIP_MEM_TEST_SIZE       (512*1024) //512KB
#define DDR4A_MEM_TEST_SIZE        (4ull*1024*1024*1024) //4GB
#define DDR4B_MEM_TEST_SIZE        (4ull*1024*1024*1024) //4GB
#define DDR4C_MEM_TEST_SIZE        (4ull*1024*1024*1024) //4GB
#define DDR4D_MEM_TEST_SIZE        (4ull*1024*1024*1024) //4GB

```

The base address of BUTTON and LED controllers are 0x4000010 and 0x4000020 based on PCIE_BAR4, respectively. The on-chip memory base address is 0x00000000 relative to the DMA controller. **The above definitions are the same as those in the PCIe Fundamental demo.**

Before accessing the FPGA through PCI Express, the application first calls PCIE_Load to dynamically load the Terasic_PCIE_AVMM.DLL. Then, it calls PCIE_Open to open the PCI Express driver. The constant DEFAULT_PCIE_VID and DEFAULT_PCIE_DID used in the PCIE_Open are defined in Terasic_PCIE_AVMM.h. If developers change the Vendor ID and Device ID and PCI Express IP, they also need to change the ID value defined in Terasic_PCIE_AVMM.h. If the return value of PCIE_Open is zero, it means the driver cannot be accessed successfully. In this case, please make sure:

- The FPGA is configured with the associated bit-stream file and the host is rebooted.
- The PCI express driver is loaded successfully.

The LED control is implemented by calling PCIE_Write32 API, as shown below:

```
bPass = PCIE_Write32(hPCIE, DEMO_PCIE_USER_BAR, DEMO_PCIE_IO_LED_ADDR, (uint32_t) Mask);
```

The button status query is implemented by calling the **PCIE_Read32** API, as shown below:

```
PCIE_Read32(hPCIE, DEMO_PCIE_USER_BAR, DEMO_PCIE_IO_BUTTON_ADDR, &Status);
```

The memory-mapped memory read and write test is implemented by **PCIE_DmaWrite** and **PCIE_DmaRead** API, as shown below:

```
PCIE_DmaWrite(hPCIE, LocalAddr, pWrite, nTestSize);  
PCIE_DmaRead(hPCIE, LocalAddr, pRead, nTestSize);
```

The PCIe link information is implemented by PCIE_ConfigRead32 API, as shown below:

```

// read config - link status
if (PCIE_ConfigRead32(hPCIE, 0x80, &Data32)) {
    switch ((Data32 >> 16) & 0x0F) {
        case 1:
            printf("Current Link Speed is Gen1\r\n");
            break;
        case 2:
            printf("Current Link Speed is Gen2\r\n");
            break;
        case 3:
            printf("Current Link Speed is Gen3\r\n");
            break;
        default:
            printf("Current Link Speed is Unknown\r\n");
            break;
    }
    switch ((Data32 >> 20) & 0x3F) {
        case 1:
            printf("Negotiated Link Width is x1\r\n");
            break;
        case 2:
            printf("Negotiated Link Width is x2\r\n");
            break;
        case 4:
            printf("Negotiated Link Width is x4\r\n");
            break;
        case 8:
            printf("Negotiated Link Width is x8\r\n");
            break;
        case 16:
            printf("Negotiated Link Width is x16\r\n");
            break;
        default:
            printf("Negotiated Link Width is Unknown\r\n");
            break;
    }
} else {
    bPass = false;
}

```

Chapter 8

PCI Express Reference Design for Linux

PCI Express is commonly used in consumer, server, and industrial applications, to link motherboard-mounted peripherals. From this demonstration, it will show how the PC Linux and FPGA communicate with each other through the PCI Express interface. Stratix 10 Hard IP for PCI Express with Avalon-MM DMA IP is used in this demonstration. For detail about this IP, please refer to Altera document [ug_s10_pcie_avmm.pdf](#).

8.1 PCI Express System Infrastructure

Figure 8-1 shows the infrastructure of the PCI Express System in this demonstration. It consists of two primary components: FPGA System and PC System. The FPGA System is developed based on Stratix 10 Hard IP for PCI Express with Avalon-MM DMA. The application software on the PC side is developed by Terasic based on Altera's PCIe kernel mode driver.

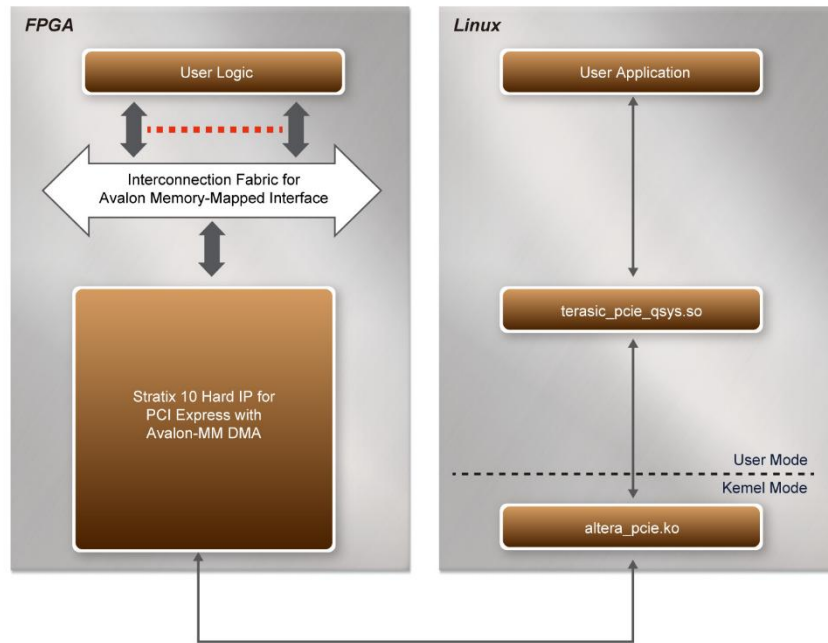

Figure 8-1 Infrastructure of PCI Express System

8.2 PC PCI Express Software SDK

The FPGA System CD contains a PC Linux based SDK to allow users to develop their 64-bit software application on 64-bits Linux. CentOS 7 is recommended. The SDK is located in the “CDROM/Demonstrations/PCle_SW_KIT/Linux” folder which includes:

- PCI Express Driver
- PCI Express Library
- PCI Express Examples

The kernel mode driver assumes the PCIe vendor ID (VID) is 0x1172 and the device ID (DID) is 0xE003. If different VID and DID are used in the design, users need to modify the PCIe vendor ID (VID) and device ID (DID) in the driver project and rebuild the driver. The ID is defined in the file PCIe_SW_KIT/Linux/PCle_Driver/altera_pcie_cmd.h.

The PCI Express Library is implemented as a single .so file named terasic_pcie_qsys.so.

This file is a 64-bit library file. With the library exported software API, users can easily communicate with the FPGA. The library provides the following functions:

- Basic data read and write
- Data read and write by DMA

For high performance data transmission, Altera AVMM DMA is required as the read and write operations are specified under the hardware design on the FPGA.

8.3 PCI Express Software Stack

Figure 8-2 shows the software stack for the PCI Express application software on 64-bit Linux. The PCIe library module `terasic_pcie_qsys.so` provides DMA and direct I/O access for user application program to communicate with FPGA. Users can develop their applications based on this `.so` library file. The `altera_pcie.ko` kernel driver is provided by Altera.

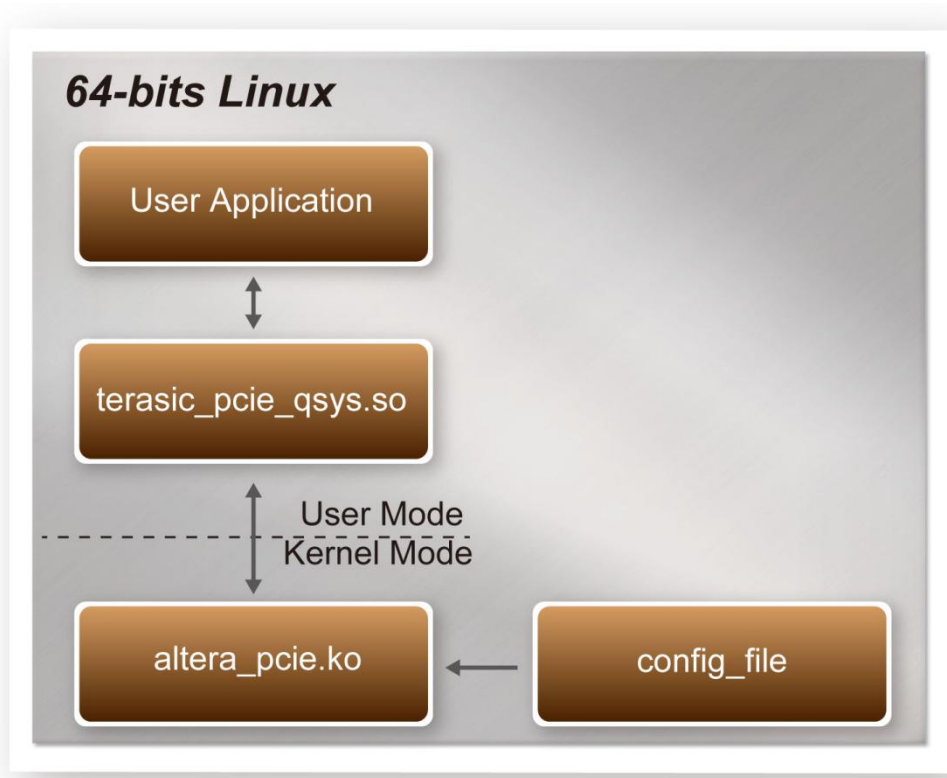

Figure 8-2 PCI Express Software Stack

■ Install PCI Express Driver on Linux

To make sure the PCIe driver can meet your kernel of Linux distribution, the driver

altera_pcie.ko should be recompiled before it is used. The PCIe driver project is located in the folder:

```
"CDROM/Demonstrations/PCIe_SW_KIT/Linux/PCIe_Driver"
```

The folder includes the following files:

- altera_pcie.c
- altera_pcie.h
- altera_pcie_cmd.h
- Makefile
- load_driver
- unload
- config_file

To compile and install the PCI Express driver, please execute the steps below:

1. Install the DE10-Pro in the PCIe slot of the host PC
2. Make sure Quartus Programmer and USB-Blaster II driver are installed
3. Open a terminal and use "cd" command to go to the folder
"CDROM/Demonstrations/PCIe_Fundamental/demo_batch".
4. Set QUARTUS_ROOTDIR variable pointing to the Quartus installation path.
Set QUARTUS_ROOTDIR variable by typing the following commands in terminal. Replace "/home/centos/intelFPGA_pro/18.1/quartus" to your quartus installation path.

```
export QUARTUS_ROOTDIR=/home/centos/intelFPGA_pro/18.1/quartus
```

5. Execute "sudo -E sh test.sh" command to configure the FPGA
6. Restart the Linux operation system. In Linux, open a terminal and use "cd" command to go to the PCIe_Driver folder
7. Type the following commands to compile and install the driver altera_pcie.ko, and make sure driver is loaded successfully and FPGA is detected by the driver as shown in **Figure 8-3**.

- make
- sudo sh load_driver
- dmesg | tail -n 15

```

centos@localhost:PCIE_Driver$ sudo sh load_driver
Matching Device Found
centos@localhost:PCIE_Driver$ dmesg | tail -n 15
[ 35.485745] SELinux: initialized (dev tmpfs, type tmpfs), uses transition SIDs
[ 246.876696] SELinux: initialized (dev tmpfs, type tmpfs), uses transition SIDs
[ 273.531603] Altera PCIe: altera_pcie_init(), May 11 2017 16:29:58
[ 273.531629] Altera PCIe 0000:01:00.0: enabling device (0000 -> 0002)
[ 273.531713] Altera PCIe 0000:01:00.0: pci_enable_device() successful
[ 273.531744] Altera PCIe 0000:01:00.0: irq 134 for MSI/MSI-X
[ 273.531754] Altera PCIe 0000:01:00.0: pci_enable_msi() successful
[ 273.531758] Altera PCIe 0000:01:00.0: BAR[0] 0xe8000000-0xe80001ff flags 0x0014220c, length 512
[ 273.531760] Altera PCIe 0000:01:00.0: BAR[1] 0x00000000-0x00000000 flags 0x00000000, length 0
[ 273.531762] Altera PCIe 0000:01:00.0: BAR[2] 0x00000000-0x00000000 flags 0x00000000, length 0
[ 273.531764] Altera PCIe 0000:01:00.0: BAR[3] 0x00000000-0x00000000 flags 0x00000000, length 0
[ 273.531766] Altera PCIe 0000:01:00.0: BAR[4] 0xe0000000-0xe7ffffff flags 0x0014220c, length 134217728
[ 273.531768] Altera PCIe 0000:01:00.0: BAR[5] 0x00000000-0x00000000 flags 0x00000000, length 0
[ 273.531783] Altera PCIe 0000:01:00.0: BAR[0] mapped to 0xffffc9000307c000, length 512
[ 273.532037] Altera PCIe 0000:01:00.0: BAR[4] mapped to 0xffffc9000c200000, length 134217728

```

Figure 8-3 Screenshot of install PCIe driver

■ Create a Software Application

All the files needed to create a PCIe software application are located in the directory CDROM/Demonstrations/PCIE_SW_KIT/Linux/PCIE_Library. It includes the following files:

- TERASIC_PCIE_AVMM.h
- terasic_pcie_qsys.so (64-bit library)

Below lists the procedures to use the library in users' C/C++ project:

1. Create a 64-bit C/C++ project.
2. Include TERASIC_PCIE_AVMM.h in the C/C++ project.
3. Copy terasic_pcie_qsys.so to the folder where the project execution file is located.
4. Dynamically load terasic_pcie_qsys.so in C/C++ program. To load the terasic_pcie_qsys.so, please refer to the PCIe fundamental example below.
5. Call the library API to implement the desired application.

Users can easily communicate with the FPGA through the PCIe bus through the terasic_pcie_qsys.so API. The details of API are described below sections.

8.4 PCI Express Library API

The API is the same as Windows Library. Please refer to the section **PCI Express Library API** in this document.

8.5 PCIe Reference Design -Fundamental

The application reference design shows how to implement fundamental control and data transfer in the DMA. In the design, basic I/O is used to control the BUTTON and LED on the FPGA board. High-speed data transfer is performed by the DMA.

■ Demonstration Files Location

The demo file is located in the batch folder:

CDROM/Demonstrations/PCIe_Fundamental/demo_batch

The folder includes following files:

- FPGA Configuration File: DE10_Pro.sof
- Download Batch file: test.sh
- Linux Application Software folder : linux_app, includes
 - ✧ PCIE_FUNDAMENTAL
 - ✧ terasic_pcie_qsys.so

■ Demonstration Setup

1. Install the FPGA board on your PC as shown in **Figure 8-4**.



Figure 8-4 FPGA board installation on PC

2. Open a terminal and use "cd" command to goto

"CDROM/Demonstrations/PCle_Fundamental/demo_batch".

3. Set QUARTUS_ROOTDIR variable pointing to the Quartus installation path. Set QUARTUS_ROOTDIR variable by typing the following commands in terminal. Replace /home/centos/intelFPGA_pro/18.1/quartus to your quartus installation path.

```
export QUARTUS_ROOTDIR=/home/centos/intelFPGA_pro/18.1/quartus
```

4. Execute "sudo -E sh test.sh" command to configure the FPGA
5. Restart Linux
6. Install PCIe driver. The driver is located in the folder:
CDROM/Demonstration/PCle_SW_KIT/Linux/PCle_Driver.
7. Type "ls -l /dev/altera_pcie*" to make sure the Linux has detected the FPGA Board. If the FPGA board is detected, developers can find the /dev/altera_pcieX(where X is 0~255) in Linux file system as shown below.

```
centos@localhost:PCie_Driver$ ls -l /dev/altera_pcie*  
crw-rw-rw-. 1 root wheel 248, 0 5月 11 15:42 /dev/altera_pcie0
```

8. Goto linux_app folder, execute PCIE_FUNDAMENTAL. A menu will appear as shown in **Figure 8-5**.

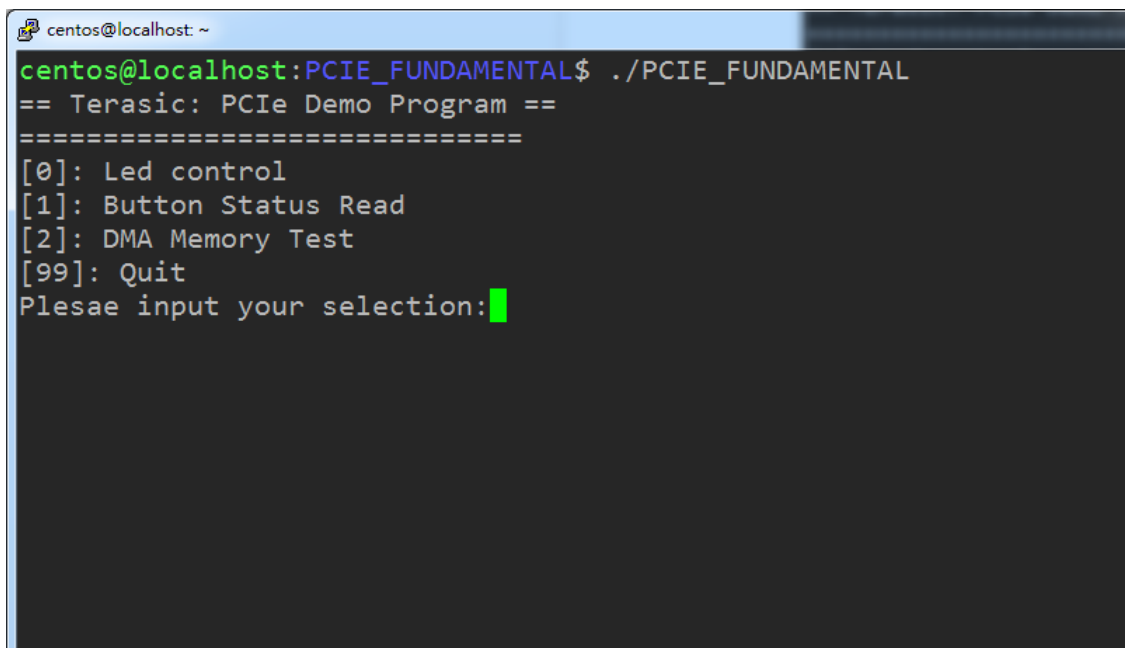

```
centos@localhost: ~  
centos@localhost:PCIE_FUNDAMENTAL$ ./PCIE_FUNDAMENTAL  
== Terasic: PCIe Demo Program ==  
=====  
[0]: Led control  
[1]: Button Status Read  
[2]: DMA Memory Test  
[99]: Quit  
Plesae input your selection: █
```

Figure 8-5 Screenshot of Program Menu

9. Type 0 followed by the ENTER key to select the Led Control item, then input 15 (hex 0x0f) will turn all leds on as shown in **Figure 8-6**. If input 0 (hex 0x00), all led will be turned off.

```
centos@localhost: ~
centos@localhost:PCIE_FUNDAMENTAL$ ./PCIE_FUNDAMENTAL
== Terasic: PCIe Demo Program ==
=====
[0]: Led control
[1]: Button Status Read
[2]: DMA Memory Test
[99]: Quit
Plesae input your selection:0
Please input led conrol mask:15
Led control success, mask=fh
=====
[0]: Led control
[1]: Button Status Read
[2]: DMA Memory Test
[99]: Quit
Plesae input your selection:█
```

Figure 8-6 Screenshot of LED Control

10. Type 1 followed by the ENTER key to select the Button Status Read item. The button status will be reported as shown in [Figure 8-7](#).

```
centos@localhost: ~
[2]: DMA Memory Test
[99]: Quit
Plesae input your selection:0
Please input led conrol mask:15
Led control success, mask=fh
=====
[0]: Led control
[1]: Button Status Read
[2]: DMA Memory Test
[99]: Quit
Plesae input your selection:1
Button status mask:=0h
=====
[0]: Led control
[1]: Button Status Read
[2]: DMA Memory Test
[99]: Quit
Plesae input your selection:█
```

Figure 8-7 Screenshot of Button Status Report

11. Type 2 followed by the ENTER key to select the DMA Testing item. The DMA test result will be reported as shown in [Figure 8-8](#).

```
centos@localhost: ~
[1]: Button Status Read
[2]: DMA Memory Test
[99]: Quit
Plesae input your selection:1
Button status mask:=0h
=====
[0]: Led control
[1]: Button Status Read
[2]: DMA Memory Test
[99]: Quit
Plesae input your selection:2
DMA-Memory (Size = 524288 bytes) pass
=====
[0]: Led control
[1]: Button Status Read
[2]: DMA Memory Test
[99]: Quit
Plesae input your selection:█
```

Figure 8-8 Screenshot of DMA Memory Test Result

12. Type 99 followed by the ENTER key to exit this test program

■ **Development Tools**

- Quartus Prime 18.1.1 Pro Edition
- GNU Compiler Collection, Version 4.8 is recommend

■ **Demonstration Source Code Location**

- Quartus Project: Demonstrations/PCle_Fundamental
- C++ Project: Demonstrations/PCle_SW_KIT/Linux/PCIE_FUNDAMENTAL

■ **FPGA Application Design**

Figure 8-9 shows the system block diagram in the FPGA system. In the Platform Designer (formerly Qsys), the PIO controller is used to control the LED and monitor the Button Status, and the On-Chip memory is used for performing DMA testing. The PIO controllers and the On-Chip memory are connected to the PCI Express Hard IP controller through the Memory-Mapped Interface.

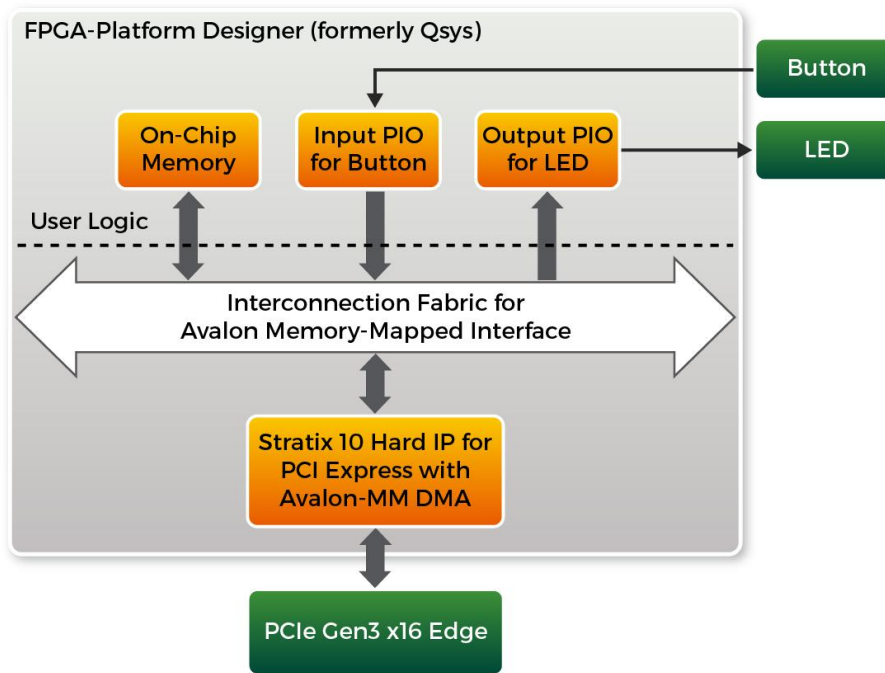

Figure 8-9 Hardware block diagram of the PCIe reference design

Linux Based Application Software Design

The application software project is built by GNU Toolchain. The project includes the following major files:

Name	Description
PCIE_FUNDAMENTAL.cpp	Main program
PCIE.c	Implement dynamically load for terasic_pcie_qsys.so
PCIE.h	library file
TERASIC_PCIE_AVMM.h	SDK library file, defines constant and data structure

The main program PCIE_FUNDAMENTAL.cpp includes the header file "PCIE.h" and defines the controller address according to the FPGA design.

```

#include "PCIE.h"

#define DEMO_PCIE_USER_BAR          PCIE_BAR4
#define DEMO_PCIE_IO_LED_ADDR      0x4000010
#define DEMO_PCIE_IO_BUTTON_ADDR  0x4000020
#define DEMO_PCIE_MEM_ADDR         0x00000000

#define MEM_SIZE                    (512*1024) //512KB

```

The base address of BUTTON and LED controllers are 0x4000010 and 0x4000020 based on PCIE_BAR4, respectively. The on-chip memory base address is 0x00000000 relative to the DMA controller.

Before accessing the FPGA through PCI Express, the application first calls PCIE_Load to dynamically load the terasic_pcie_qsys.so. Then, it call PCIE_Open to open the PCI Express driver. The constant DEFAULT_PCIE_VID and DEFAULT_PCIE_DID used in PCIE_Open are defined in Terasic_PCIE_AVMM.h. If developers change the Vendor ID and Device ID and PCI Express IP, they also need to change the ID value defined in Terasic_PCIE_AVMM.h. If the return value of PCIE_Open is zero, it means the driver cannot be accessed successfully. In this case, please make sure:

- The FPGA is configured with the associated bit-stream file and the host is rebooted.
- The PCI express driver is loaded successfully.

The LED control is implemented by calling PCIE_Write32 API, as shown below:

```
bPass = PCIE_Write32(hPCIE, DEMO_PCIE_USER_BAR, DEMO_PCIE_IO_LED_ADDR, (uint32_t) Mask);
```

The button status query is implemented by calling the PCIE_Read32 API, as shown below:

```
PCIE_Read32(hPCIE, DEMO_PCIE_USER_BAR, DEMO_PCIE_IO_BUTTON_ADDR, &Status);
```

The memory-mapped memory read and write test is implemented by PCIE_DmaWrite and PCIE_DmaRead API, as shown below:

```
PCIE_DmaWrite(hPCIE, LocalAddr, pWrite, nTestSize);  
PCIE_DmaRead(hPCIE, LocalAddr, pRead, nTestSize);
```

8.6 PCIe Reference Design - DDR4

The application reference design shows how to add DDR4 Memory Controllers for DDR4-A SODIMM, DDR4-B SODIMM, DDR4-C SODIMM and DDR4-D SODIMM into the PCIe Quartus project based on the PCIe_Fundamental Quartus project and perform 4GB data DMA for both SODIMM. Also, this demo shows how to call “PCIE_ConfigRead32” API to check PCIe link status.

■ Demonstration Files Location

The demo file is located in the batch folder:

CDROM/Demonstrations/PCIe_DDR4/demo_batch

The folder includes following files:

- FPGA Configuration File: DE10_pro.sof
- Download Batch file: test.sh
- Linux Application Software folder : linux_app, includes
 - ✧ PCIE_DDR4
 - ✧ terasic_pcie_qsys.so

■ Demonstration Setup

1. Install four pieces of DDR4 2400 4GB SODIMM on the FPGA board.
2. Install the FPGA board on the PCIe Slot of your PC.
3. Open a terminal and use "cd" command to go to "CDROM/Demonstrations/PCIe_DDR4/demo_batch".
4. Set QUARTUS_ROOTDIR variable pointing to the Quartus installation path. Set QUARTUS_ROOTDIR variable by typing the following commands in the terminal. Replace /home/centos/intelFPGA_pro/18.1/quartus to your Quartus installation path.

```
export QUARTUS_ROOTDIR=/home/centos/intelFPGA_pro/18.1/quartus
```

5. Execute "sudo -E sh test.sh" command to configure the FPGA
6. Restart Linux
7. Install PCIe driver.
8. Make sure that Linux has detected the FPGA Board.
9. Go to the linux_app folder, execute PCIE_DDR4. A menu will appear as shown in

Figure 8-10.

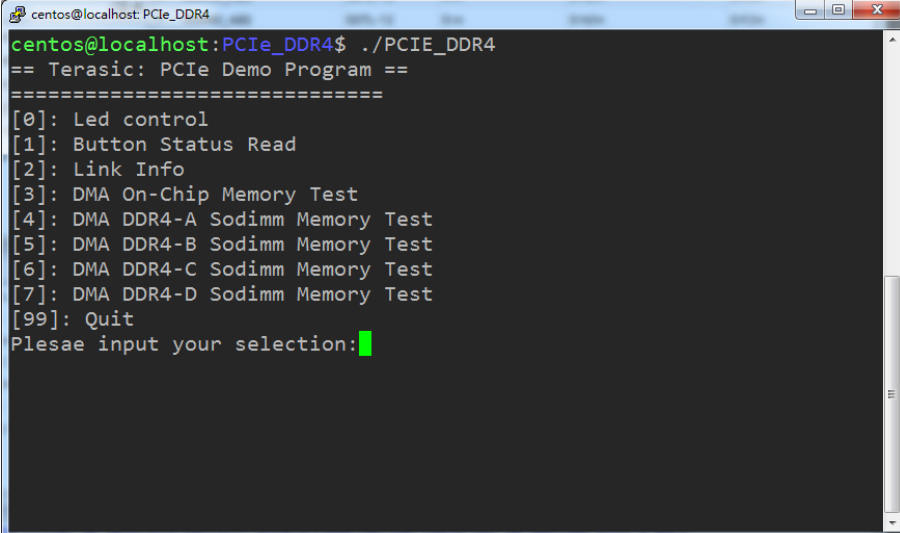

```
centos@localhost: PCIE_DDR4
centos@localhost:PCIE_DDR4$ ./PCIE_DDR4
== Terasic: PCIe Demo Program ==
=====
[0]: Led control
[1]: Button Status Read
[2]: Link Info
[3]: DMA On-Chip Memory Test
[4]: DMA DDR4-A Sodimm Memory Test
[5]: DMA DDR4-B Sodimm Memory Test
[6]: DMA DDR4-C Sodimm Memory Test
[7]: DMA DDR4-D Sodimm Memory Test
[99]: Quit
Plesae input your selection:█
```

Figure 8-10 Screenshot of Program Menu

10. Type 2 followed by the ENTER key to select the Link Info item. The PCIe link information will be shown as in **Figure 8-11**. Gen3 link speed and x8 link width are expected.

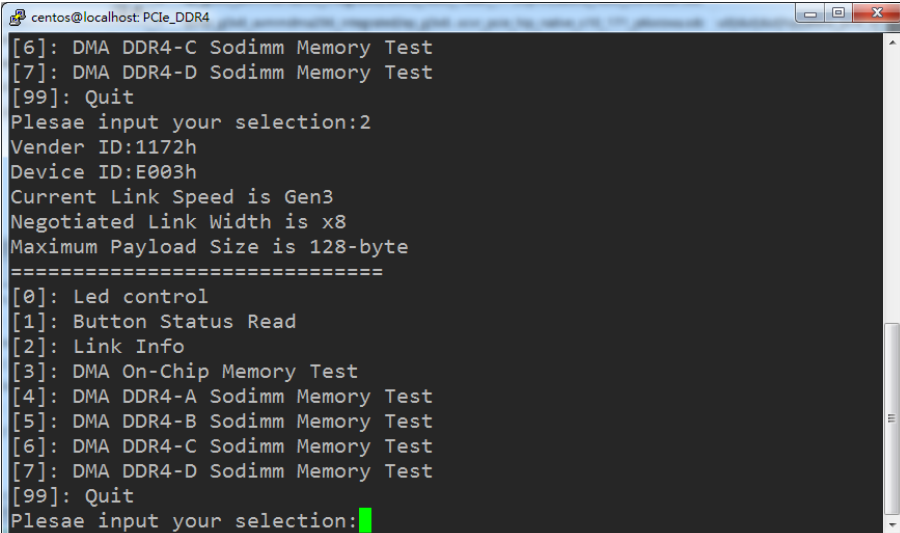

```
centos@localhost: PCIE_DDR4
[6]: DMA DDR4-C Sodimm Memory Test
[7]: DMA DDR4-D Sodimm Memory Test
[99]: Quit
Plesae input your selection:2
Vender ID:1172h
Device ID:E003h
Current Link Speed is Gen3
Negotiated Link Width is x8
Maximum Payload Size is 128-byte
=====
[0]: Led control
[1]: Button Status Read
[2]: Link Info
[3]: DMA On-Chip Memory Test
[4]: DMA DDR4-A Sodimm Memory Test
[5]: DMA DDR4-B Sodimm Memory Test
[6]: DMA DDR4-C Sodimm Memory Test
[7]: DMA DDR4-D Sodimm Memory Test
[99]: Quit
Plesae input your selection:█
```

Figure 8-11 Screenshot of Link Info

11. Type 3 followed by the ENTER key to select DMA On-Chip Memory Test item. The DMA write and read test result will be report as shown in **Figure 8-12**.

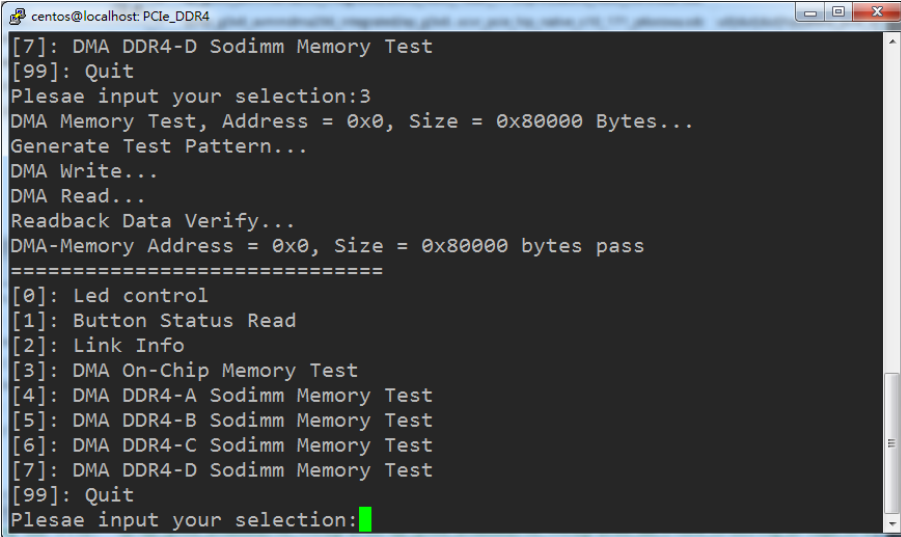

```
centos@localhost: PCIe_DDR4
[7]: DMA DDR4-D Sodimm Memory Test
[99]: Quit
Plesae input your selection:3
DMA Memory Test, Address = 0x0, Size = 0x80000 Bytes...
Generate Test Pattern...
DMA Write...
DMA Read...
Readback Data Verify...
DMA-Memory Address = 0x0, Size = 0x80000 bytes pass
=====
[0]: Led control
[1]: Button Status Read
[2]: Link Info
[3]: DMA On-Chip Memory Test
[4]: DMA DDR4-A Sodimm Memory Test
[5]: DMA DDR4-B Sodimm Memory Test
[6]: DMA DDR4-C Sodimm Memory Test
[7]: DMA DDR4-D Sodimm Memory Test
[99]: Quit
Plesae input your selection:█
```

Figure 8-12 Screenshot of On-Chip Memory DMA Test Result

12. Type 4 followed by the ENTER key to select the DMA DDR4-A SODIMM Memory Test item. The DMA write and read test result will be reported as shown in **Figure 8-13**.

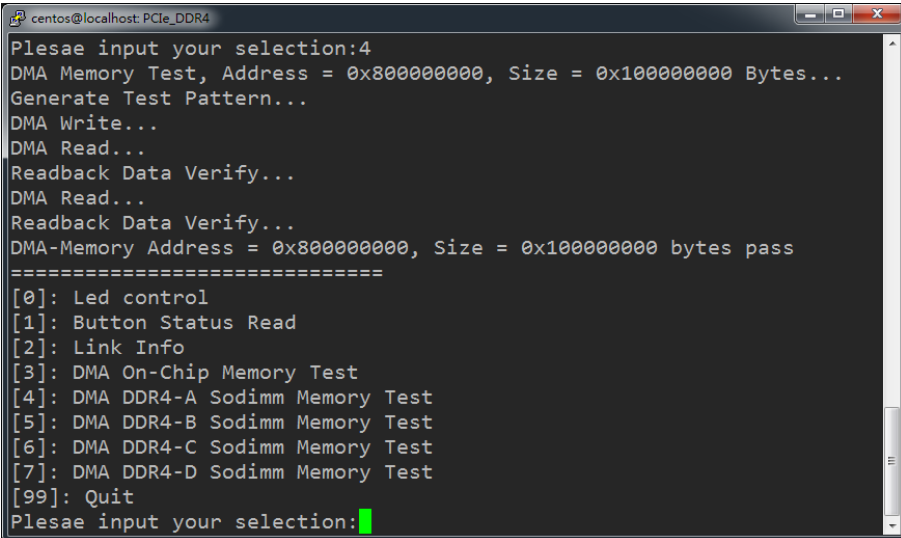

```
centos@localhost: PCIe_DDR4
Plesae input your selection:4
DMA Memory Test, Address = 0x80000000, Size = 0x10000000 Bytes...
Generate Test Pattern...
DMA Write...
DMA Read...
Readback Data Verify...
DMA Read...
Readback Data Verify...
DMA-Memory Address = 0x80000000, Size = 0x10000000 bytes pass
=====
[0]: Led control
[1]: Button Status Read
[2]: Link Info
[3]: DMA On-Chip Memory Test
[4]: DMA DDR4-A Sodimm Memory Test
[5]: DMA DDR4-B Sodimm Memory Test
[6]: DMA DDR4-C Sodimm Memory Test
[7]: DMA DDR4-D Sodimm Memory Test
[99]: Quit
Plesae input your selection:█
```

Figure 8-13 Screenshot of DDR4-A SOSIMM Memory DAM Test Result

13. Type 5 followed by the ENTER key to select the DMA DDR4-B SODIMM Memory Test item. The DMA write and read test result will be reported as shown in **Figure**

8-14.

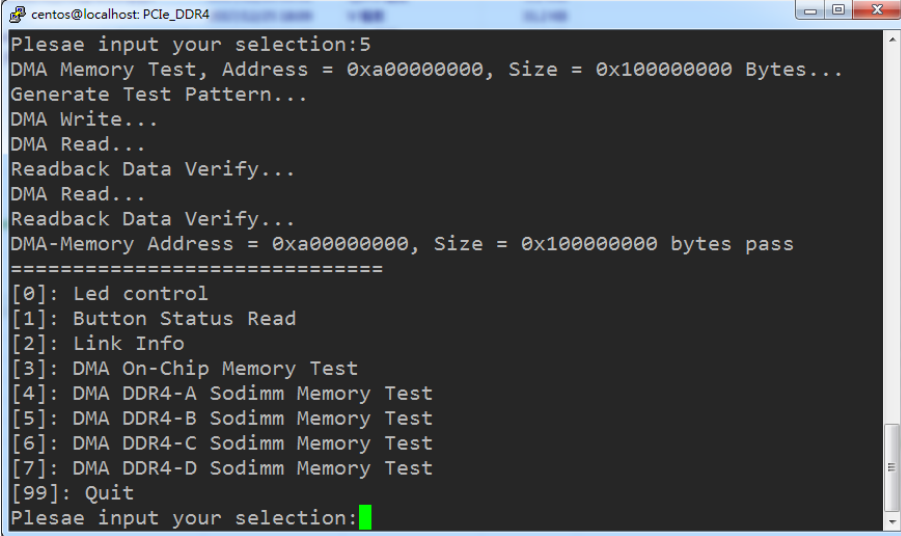

```
centos@localhost: PCIe_DDR4
Plesae input your selection:5
DMA Memory Test, Address = 0xa0000000, Size = 0x10000000 Bytes...
Generate Test Pattern...
DMA Write...
DMA Read...
Readback Data Verify...
DMA Read...
Readback Data Verify...
DMA-Memory Address = 0xa0000000, Size = 0x10000000 bytes pass
=====
[0]: Led control
[1]: Button Status Read
[2]: Link Info
[3]: DMA On-Chip Memory Test
[4]: DMA DDR4-A Sodimm Memory Test
[5]: DMA DDR4-B Sodimm Memory Test
[6]: DMA DDR4-C Sodimm Memory Test
[7]: DMA DDR4-D Sodimm Memory Test
[99]: Quit
Plesae input your selection:
```

Figure 8-14 Screenshot of DDR4-B SOSIMM Memory DAM Test Result

14. Type 6 followed by the ENTER key to select the DMA DDR4-C SODIMM Memory Test item. The DMA write and read test result will be reported as shown in **Figure 8-15**.

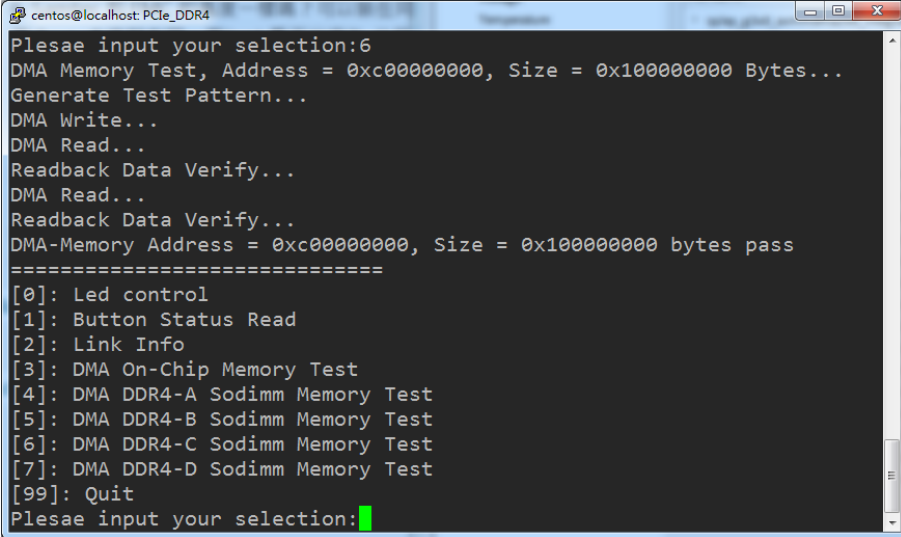

```
centos@localhost: PCIe_DDR4
Plesae input your selection:6
DMA Memory Test, Address = 0xc0000000, Size = 0x10000000 Bytes...
Generate Test Pattern...
DMA Write...
DMA Read...
Readback Data Verify...
DMA Read...
Readback Data Verify...
DMA-Memory Address = 0xc0000000, Size = 0x10000000 bytes pass
=====
[0]: Led control
[1]: Button Status Read
[2]: Link Info
[3]: DMA On-Chip Memory Test
[4]: DMA DDR4-A Sodimm Memory Test
[5]: DMA DDR4-B Sodimm Memory Test
[6]: DMA DDR4-C Sodimm Memory Test
[7]: DMA DDR4-D Sodimm Memory Test
[99]: Quit
Plesae input your selection:
```

Figure 8-15 Screenshot of DDR4-C SOSIMM Memory DAM Test Result

15. Type 7 followed by the ENTER key to select the DMA DDR4-D SODIMM Memory Test item. The DMA write and read test result will be reported as shown in **Figure 8-16**.

```
centos@localhost: PCIe_DDR4
Plesae input your selection:7
DMA Memory Test, Address = 0xe0000000, Size = 0x10000000 Bytes...
Generate Test Pattern...
DMA Write...
DMA Read...
Readback Data Verify...
DMA Read...
Readback Data Verify...
DMA-Memory Address = 0xe0000000, Size = 0x10000000 bytes pass
=====
[0]: Led control
[1]: Button Status Read
[2]: Link Info
[3]: DMA On-Chip Memory Test
[4]: DMA DDR4-A Sodimm Memory Test
[5]: DMA DDR4-B Sodimm Memory Test
[6]: DMA DDR4-C Sodimm Memory Test
[7]: DMA DDR4-D Sodimm Memory Test
[99]: Quit
Plesae input your selection:█
```

Figure 8-16 Screenshot of DDR4-D SODIMM Memory DAM Test Result

16. Type 99 followed by the ENTER key to exit this test program.

■ Development Tools

- Quartus Prime 18.1.1 Pro Edition
- GNU Compiler Collection, Version 4.8 is recommended

■ Demonstration Source Code Location

- Quartus Project: Demonstrations/PCIE_DDR4
- C++ Project: Demonstrations/PCIe_SW_KIT/Linux/PCIe_DDR4

■ FPGA Application Design

Figure 8-17 shows the system block diagram in the FPGA system. In the **Platform Designer** (formerly Qsys), Altera PIO controller is used to control the LED and monitor the Button Status, and the On-Chip memory is used for performing DMA testing. The PIO controllers and the On-Chip memory are connected to the PCI Express Hard IP controller through the Memory-Mapped Interface.

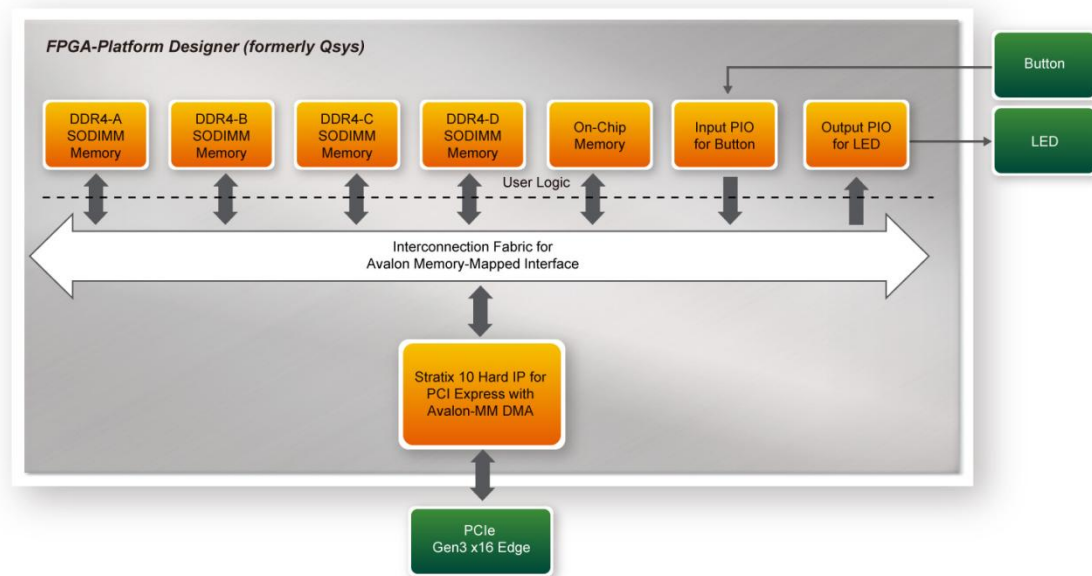

Figure 8-17 Hardware block diagram of the PCIe_DDR4 reference design

■ Linux Based Application Software Design

The application software project is built by GNU Toolchain. The project includes the following major files:

Name	Description
PCIE_DDR4.cpp	Main program
PCIE.c	Implement dynamically load for terasic_pcie_qsys.so
PCIE.h	library file
TERASIC_PCIE_AVMM.h	SDK library file, defines constant and data structure

The main program PCIE_DDR4.cpp includes the header file "PCIE.h" and defines the controller address according to the FPGA design.

```

#define DEMO_PCIE_USER_BAR          PCIE_BAR4
#define DEMO_PCIE_IO_LED_ADDR       0x4000010
#define DEMO_PCIE_IO_BUTTON_ADDR    0x4000020
#define DEMO_PCIE_ONCHIP_MEM_ADDR   0x00000000
#define DEMO_PCIE_DDR4A_MEM_ADDR    0x80000000
#define DEMO_PCIE_DDR4B_MEM_ADDR    0xA0000000
#define DEMO_PCIE_DDR4C_MEM_ADDR    0xC0000000
#define DEMO_PCIE_DDR4D_MEM_ADDR    0xE0000000

#define ONCHIP_MEM_TEST_SIZE        (512*1024) //512KB
#define DDR4A_MEM_TEST_SIZE         (4ull*1024*1024*1024) //4GB
#define DDR4B_MEM_TEST_SIZE         (4ull*1024*1024*1024) //4GB
#define DDR4C_MEM_TEST_SIZE         (4ull*1024*1024*1024) //4GB
#define DDR4D_MEM_TEST_SIZE         (4ull*1024*1024*1024) //4GB

```

The base address of BUTTON and LED controllers are 0x4000010 and 0x4000020 based on PCIE_BAR4, respectively. The on-chip memory base address is 0x00000000 relative to the DMA controller. **The above definition is the same as those in PCIe Fundamental demo.**

Before accessing the FPGA through PCI Express, the application first calls the PCIE_Load to dynamically load the terasic_pcie_qsys.so. Then, it calls the PCIE_Open to open the PCI Express driver. The constant DEFAULT_PCIE_VID and DEFAULT_PCIE_DID used in the PCIE_Open are defined in Terasic_PCIE_AVMM.h. If developers changes the Vendor ID and Device ID and PCI Express IP, they also need to change the ID value defined in Terasic_PCIE_AVMM.h. If the return value of the PCIE_Open is zero, it means the driver cannot be accessed successfully. In this case, please make sure:

- The FPGA is configured with the associated bit-stream file and the host is rebooted.
- The PCI express driver is loaded successfully.

The LED control is implemented by calling PCIE_Write32 API, as shown below:

```
bPass = PCIE_Write32(hPCIE, DEMO_PCIE_USER_BAR, DEMO_PCIE_IO_LED_ADDR, (uint32_t) Mask);
```

The button status query is implemented by calling the PCIE_Read32 API, as shown below:

```
PCIE_Read32(hPCIE, DEMO_PCIE_USER_BAR, DEMO_PCIE_IO_BUTTON_ADDR, &Status);
```

The memory-mapped memory read and write test is implemented via **PCIE_DmaWrite** and the **PCIE_DmaRead** API, as shown below:

```
PCIE_DmaWrite(hPCIE, LocalAddr, pWrite, nTestSize);  
PCIE_DmaRead(hPCIE, LocalAddr, pRead, nTestSize);
```

The PCIe link information is implemented by **PCIE_ConfigRead32** API, as shown below:

```
// read config - link status  
if (PCIE_ConfigRead32(hPCIE, 0x80, &Data32)) {  
    switch ((Data32 >> 16) & 0x0F) {  
        case 1:  
            printf("Current Link Speed is Gen1\r\n");  
            break;  
        case 2:  
            printf("Current Link Speed is Gen2\r\n");  
            break;  
        case 3:  
            printf("Current Link Speed is Gen3\r\n");  
            break;  
        default:  
            printf("Current Link Speed is Unknown\r\n");  
            break;  
    }  
    switch ((Data32 >> 20) & 0x3F) {  
        case 1:  
            printf("Negotiated Link Width is x1\r\n");  
            break;  
        case 2:  
            printf("Negotiated Link Width is x2\r\n");  
            break;  
        case 4:  
            printf("Negotiated Link Width is x4\r\n");  
            break;  
        case 8:  
            printf("Negotiated Link Width is x8\r\n");  
            break;  
        case 16:  
            printf("Negotiated Link Width is x16\r\n");  
            break;  
        default:  
            printf("Negotiated Link Width is Unknown\r\n");  
            break;  
    }  
    } else {  
        bPass = false;  
    }  
}
```

Chapter 9

Transceiver Verification

This chapter describes how to verify the FPGA transceivers via the QSFP28 connector. There are two test codes available in the DE10-Pro System CD. The two test codes are called the Transceiver_Test and the Ethernet_100G. The source code of the Ethernet_100G is also available in the in the DE10-Pro system CD.

9.1 Transceiver Test Code

The transceiver test code is used to verify the transceiver channels via the QSFP28 ports through an external loopback method. The transceiver channels are verified with the data rates 10.3125 Gbps for the L-Tile FPGA and 25.78125 Gbps for the H-Tile FPGA with PRBS31 test pattern.

9.2 Loopback Fixture

To enable an external loopback of the transceiver channels, QSFP28 loopback fixtures, as shown in **Figure 9-1**, are required. The fixture is available at:

<https://multilaneinc.com/product/ml4002-28/>



Figure 9-1 QSFP28 Loopback Cable

Figure 9-2 shows the FPGA board with four QSFP28 loopback fixtures installed.



Figure 9-2 QSFP28 Transceiver Loopback Test in Progress

9.3 Testing by Transceiver Test Code

The transceiver test code is available in the folder System CD\Tool\Transceiver_Test, which has two QSFP transceiver loopback test codes, "Datarate10G" and "Datarate25G8".

The "Datarate25G8" test code is only used for the H-title FPGA of the DE10-Pro. **Figure 9-3** shows the Transceiver Native PHY IP settings in the test code. The data rate of each transceiver channel is set to 25781.25 Mbps. So the 100Gbps QSFP28 loopback test code is implemented (four channels in total).

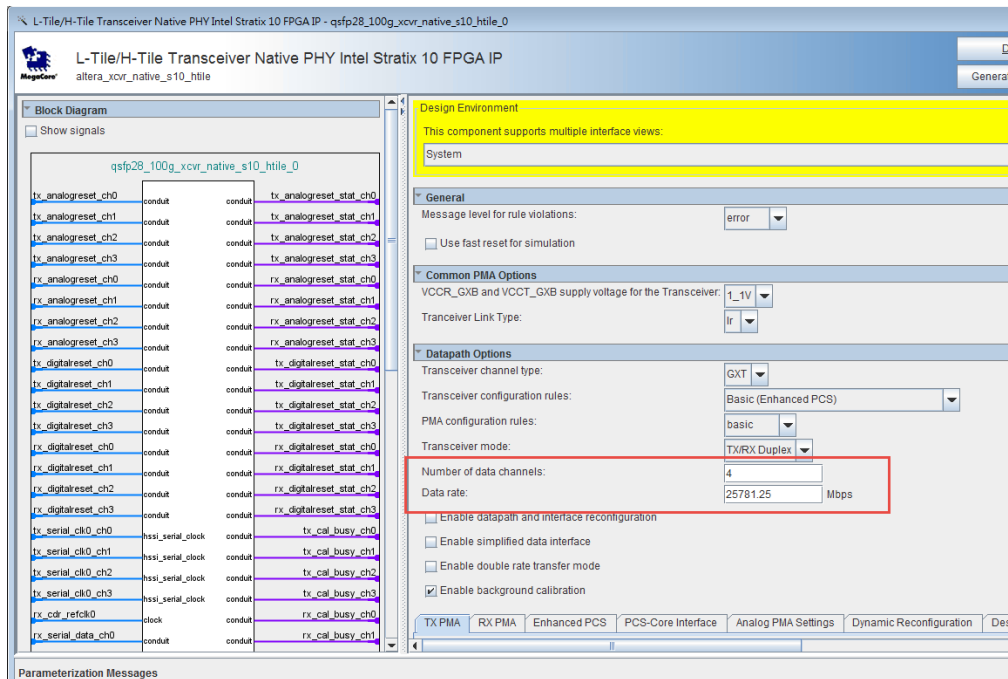

Figure 9-3 The Transceiver PHY setting

"Datarate10G" test code, whether it is H-title or L-title FPGA of the DE10-Pro can use the test code. The data rate of the transceiver channel used in the test code is 10.3125Gpbs. The 40Gbps QSFP loopback test function is realized.

The FPGA transceiver PMA setting used are shown in the table below.

Direction	Item	Value
TX	VOD Control	31
	Pre-emphasis first post-tap	-3
	Pre-emphasis pre-tap	-6
RX	Adaptive CTLE, Adaptive VGA, All-Tap, Adaptive DFE	

Here are the procedures to perform transceiver channel test:

1. Copy the Transceiver_Test folder to your local disk.
2. Ensure that the FPGA board is NOT powered on.

3. Plug-in the QSPF28 loopback fixtures.
4. Connect your FPGA board to your PC with a micro USB cable.
5. Power on the FPGA board
6. Execute 'test.bat" in the Transceiver_Test folder under your local disk.
7. The batch file will download .sof and .elf files, and start the test immediately.
The test result is shown in the Nios II Terminal, as shown in **Figure 9-4**.
8. To terminate the test, press one of the BUTTON0~1 buttons on the FPGA board. The loopback test will terminate as shown in **Figure 9-5**.

```

C:\cygdrive\ff\de10-pro\Transceiver_Test
Transceiver for QSPF28 testing...
Press buttons on the board can terminate the testing.
Apply default setting...done
==== Time Elapsed: 0 Seconds ====
QSPF28_a-0: PASS, XferCnt:2990161920<0.35GB>
QSPF28_a-1: PASS, XferCnt:2989981696<0.35GB>
QSPF28_a-2: PASS, XferCnt:2987868160<0.35GB>
QSPF28_a-3: PASS, XferCnt:2987679744<0.35GB>
QSPF28_B-0: PASS, XferCnt:2985803776<0.35GB>
QSPF28_B-1: PASS, XferCnt:2984075264<0.35GB>
QSPF28_B-2: PASS, XferCnt:2983321600<0.35GB>
QSPF28_B-3: PASS, XferCnt:2982715392<0.35GB>
QSPF28_C-0: PASS, XferCnt:2983788544<0.35GB>
QSPF28_C-1: PASS, XferCnt:2979930112<0.35GB>
QSPF28_C-2: PASS, XferCnt:2980913152<0.35GB>
QSPF28_C-3: PASS, XferCnt:2978832384<0.35GB>
QSPF28_D-0: PASS, XferCnt:2978127872<0.35GB>
QSPF28_D-1: PASS, XferCnt:2976071680<0.35GB>
QSPF28_D-2: PASS, XferCnt:2978037760<0.35GB>
QSPF28_D-3: PASS, XferCnt:2976538624<0.35GB>
==== Time Elapsed: 5 Seconds ====
QSPF28_a-0: PASS, XferCnt:54550798336<6.35GB>
QSPF28_a-1: PASS, XferCnt:54550618112<6.35GB>
QSPF28_a-2: PASS, XferCnt:54548512768<6.35GB>

```

Figure 9-4 QSPF28 Transceiver Loopback Test in Progress

```
Altera Nios II EDS 18.0 [gcc4]
QSFP28_C-2: PASS, XferCnt:312351596544<36.36GB>
QSFP28_C-3: PASS, XferCnt:312352260096<36.36GB>
QSFP28_D-0: PASS, XferCnt:312347762688<36.36GB>
QSFP28_D-1: PASS, XferCnt:312345305088<36.36GB>
QSFP28_D-2: PASS, XferCnt:312345124864<36.36GB>
QSFP28_D-3: PASS, XferCnt:312342962176<36.36GB>
==== Time Elapsed: 35 Seconds ====
QSFP28_A-0: PASS, XferCnt:363922292736<42.37GB>
QSFP28_A-1: PASS, XferCnt:363922112512<42.37GB>
QSFP28_A-2: PASS, XferCnt:363920211968<42.37GB>
QSFP28_A-3: PASS, XferCnt:363920031744<42.37GB>
QSFP28_B-0: PASS, XferCnt:363922735104<42.37GB>
QSFP28_B-1: PASS, XferCnt:363920556032<42.37GB>
QSFP28_B-2: PASS, XferCnt:363922644992<42.37GB>
QSFP28_B-3: PASS, XferCnt:363918901248<42.37GB>
QSFP28_C-0: PASS, XferCnt:363917877248<42.37GB>
QSFP28_C-1: PASS, XferCnt:363918819328<42.37GB>
QSFP28_C-2: PASS, XferCnt:363914051584<42.37GB>
QSFP28_C-3: PASS, XferCnt:363914706944<42.37GB>
QSFP28_D-0: PASS, XferCnt:363909718016<42.36GB>
QSFP28_D-1: PASS, XferCnt:363907260416<42.36GB>
QSFP28_D-2: PASS, XferCnt:363907072000<42.36GB>
QSFP28_D-3: PASS, XferCnt:363904917504<42.36GB>
user abort!
stop xcvr...
disable PRBS...
Transceiver Testing is terminated.
```

Figure 9-5 QSFP28 Transceiver Loopback is terminated

9.4 100G Ethernet Example (H-Tile FPGA)

This 100G Ethernet example is generated according to the documents [Low Latency 100G Ethernet Example Design User Guide](#). The Stratix 10 LL(Low Latency) 100GbE IP is used in the example design. This example executes the external loopback test through one of the QSFP28 ports on the FPGA main board. A QSFP28 loopback fixture is required to perform this demonstration. **Figure 9-6** shows the block diagram of this demonstration.

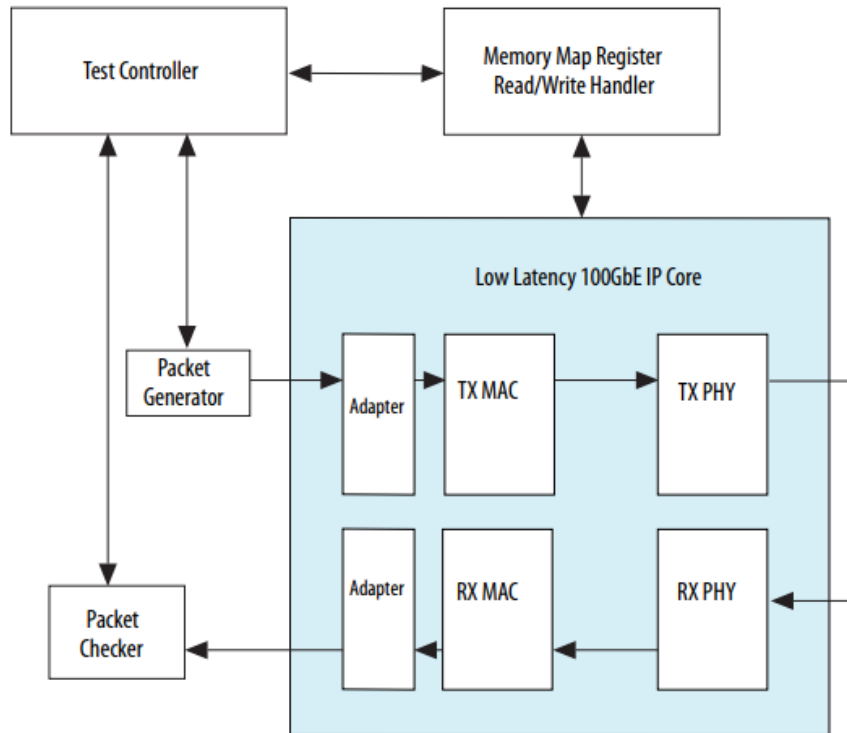

Figure 9-6 Block diagram of 100GbE demo

■ Project Information

The Quartus project information is shown in the table below.

Item	Description
Project Location	CDROM/Demonstrations/alt_e100s10
Quartus Project	CDROM/Demonstrations/alt_e100s10/hardware_test_design
FPGA Bit Stream	CDROM/Demonstrations/alt_e100s10/hardware_test_design/output_files/alt_e100s10.sof
Test Scrip File	CDROM/Demonstrations/ alt_e100s10//hardware_test_design/hwtest/main.tcl
Quartus Version	Quartus Prime 18.1.1 Pro Edition

■ Demonstration Setup

Here is the procedure to setup the demonstration. A QSFP28 loopback fixture is required for this demonstration. If you don't have a QSFP28 loopback fixture, please use **run_test** instead of **run_external_test** in the following demonstration procedure. The **run_test** is used to enable transceiver serial loopback for internal loopback.

1. Insert a QSFP28 loopback fixture into the QSFP28-A port on the DE10-Pro board, as shown in **Figure 9-7**.
2. Connect the host PC to the FPGA board using a micro-USB cable. Please make sure the USB-Blaster II driver is installed on the host PC.
3. Launch Quartus Prime programmer and make sure the USB-Blaster II is detected correctly.
4. In the Quartus Prime Programmer, add the configuration bit stream file (./output_files/alt_e100s10.sof). Check the associated “Program/Configure” item and click “Start” to start the FPGA programming.
5. Launch the System Console by selecting the menu item “Tools→System Debugging Tools→System Console” in Quartus.
6. In the System Console window, input the following commands to start the loopback test, as shown in **Figure 9-8**.

```
%cd hwtest  
%source main.tcl  
%run_external_test
```

7. The loopback test report will be displayed in the Tcl Console, as shown in **Figure 9-9** and **Figure 9-9**.



Figure 9-7 Setup QSFP28 loopback fixture

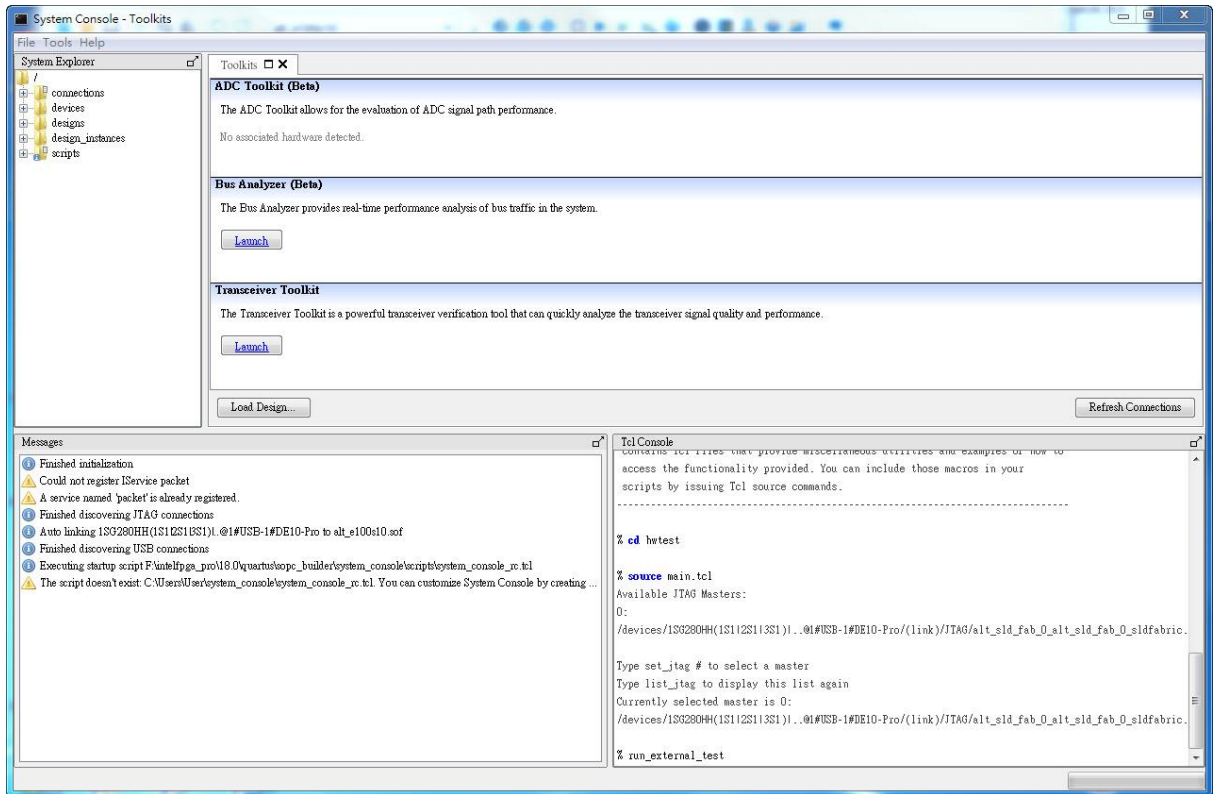

Figure 9-8 Launch the System Console for Ethernet 100G Demo

```
Tcl Console
=====
                        STATISTICS FOR BASE 0x0900 (Rx)
=====
Fragmented Frames           : 0
Jabbered Frames             : 0
Any Size with FCS Err Frame : 0
Right Size with FCS Err Fra : 0
Multicast data Err Frames   : 0
Broadcast data Err Frames   : 0
Unicast data Err Frames     : 0
Multicast control Err Frame : 0
Broadcast control Err Frame : 0
Unicast control Err Frames  : 0
Pause control Err Frames    : 0
64 Byte Frames              : 7233
65 - 127 Byte Frames        : 7070
128 - 255 Byte Frames       : 14612
256 - 511 Byte Frames       : 28659
512 - 1023 Byte Frames      : 57228
1024 - 1518 Byte Frames     : 55649
1519 - MAX Byte Frames      : 1666097
> MAX Byte Frames           : 0
Rx Frame Starts             : 0
Multicast data OK Frame     : 0
Broadcast data OK Frame     : 0
Unicast data OK Frames      : 1836548
Multicast Control Frames    : 0
Broadcast Control Frames    : 0
Unicast Control Frames      : 0
Pause Control Frames        : 0
```

Figure 9-9 Ethernet 100G loopback test report for RX

```
Tel Console
=====
                        STATISTICS FOR BASE 0x0800 (Tx)
=====
Fragmented Frames      : 0
Jabbered Frames        : 0
Any Size with FCS Err Frame : 0
Right Size with FCS Err Fra : 0
Multicast data Err Frames : 0
Broadcast data Err Frames : 0
Unicast data Err Frames  : 0
Multicast control Err Frame : 0
Broadcast control Err Frame : 0
Unicast control Err Frames : 0
Pause control Err Frames : 0
64 Byte Frames         : 7233
65 - 127 Byte Frames   : 7070
128 - 255 Byte Frames  : 14612
256 - 511 Byte Frames  : 28659
512 - 1023 Byte Frames : 57228
1024 - 1518 Byte Frames : 55649
1519 - MAX Byte Frames : 1666097
> MAX Byte Frames      : 0
Tx Frame Starts        : 0
Multicast data OK Frame : 0
Broadcast data OK Frame : 0
Unicast data OK Frames  : 1836548
Multicast Control Frames : 0
Broadcast Control Frames : 0
Unicast Control Frames  : 0
Pause Control Frames    : 0
----- Done -----
```

Figure 9-9 Ethernet 100G loopback test report for TX

9.5 40G Ethernet Example (L-Tile FPGA)

This 40G Ethernet example is generated according to the documents [Stratix 10 Low Latency 40G Ethernet Design Example User Guide](#). The Stratix 10 LL(Low Latency) 40GbE IP is used in the example design. This example executes the external loopback test through one of the QSFP28 ports on the FPGA main board. A QSFP28 loopback fixture is required to perform this demonstration. **Figure 9-10** shows the block diagram of this demonstration.

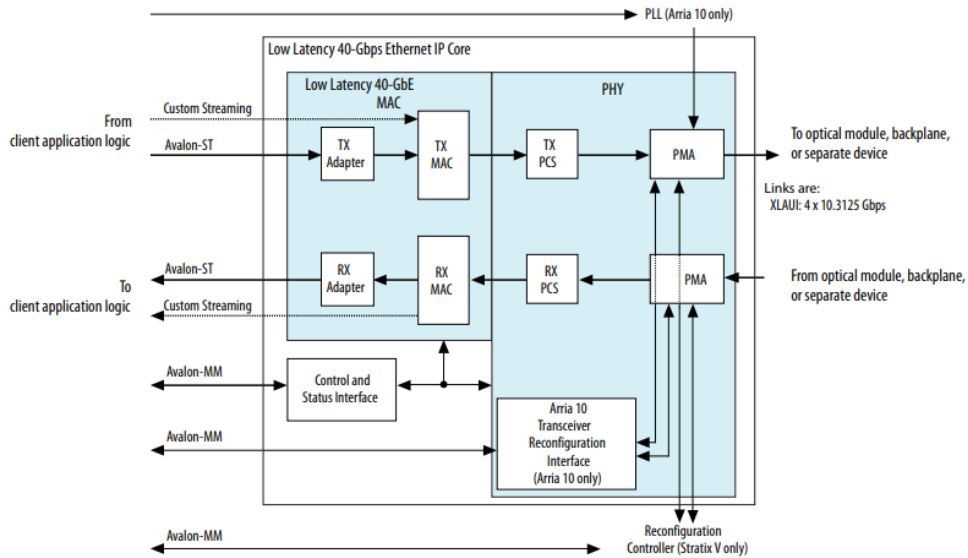

Figure 9-10 Block diagram of 40GbE demo

■ Project Information

The Project information is shown in the table below.

Item	Description
Project Location	CDROM/Demonstrations/alt_e40
Quartus Project	CDROM/Demonstrations/alt_e40/hardware_test_design
FPGA Bit Stream	CDROM/Demonstrations/alt_e40/hardware_test_design/output_files/eth_ex_40g.sof
Test Scrip File	CDROM/Demonstrations/alt_e40/hardware_test_design/hwtest/main.tcl
Quartus Version	Quartus Prime 18.1.1 Pro Edition

■ Demonstration Setup

Here is the procedure to setup the demonstration. A QSFP28 loopback fixture is required for this demonstration. If you don't have a QSFP28 loopback fixture, please use **run_test** instead of **run_external_test** in the following demonstration procedure. The **run_test** is used to enable transceiver serial loopback for internal loopback.

1. Insert a QSFP28 loopback fixture into the QSFP28-A port on the DE10-Pro board, as shown in **Figure 9-7**.
2. Connect the host PC to the FPGA board using a micro-USB cable. Please make sure the USB-Blaster II driver is installed on the host PC.

3. Launch Quartus Prime programmer and make sure the USB-Blaster II is detected correctly.
4. In the Quartus Prime Programmer, add the configuration bit stream file (./hardware_test_design/output_files/eth_ex_40g.sof). Check the associated “Program/Configure” item and click “Start” to start the FPGA programming.
5. Launch the System Console by selecting the menu item “Tools→System Debugging Tools→System Console” in Quartus.
6. In the Tcl Console pane, type “cd hwtest” to change directory to the folder: ./alt_s40/hardware_test_design/hwtest. Then, type “source main.tcl” to open a connection to the JTAG master as shown in **Figure 9-11**.
7. If you have a QSFP28 loopback fixture installed, type “loop_off” to turns off internal serial loopback. Otherwise, type “loop_on” to turn on internal serial loopback.
8. Type “start_pkt_gen” to starts the packet generator.
9. Type “chkmac_stats” to display the values in the MAC statics counters, as shown in **Figure 9-12** and **Figure 9-13**.

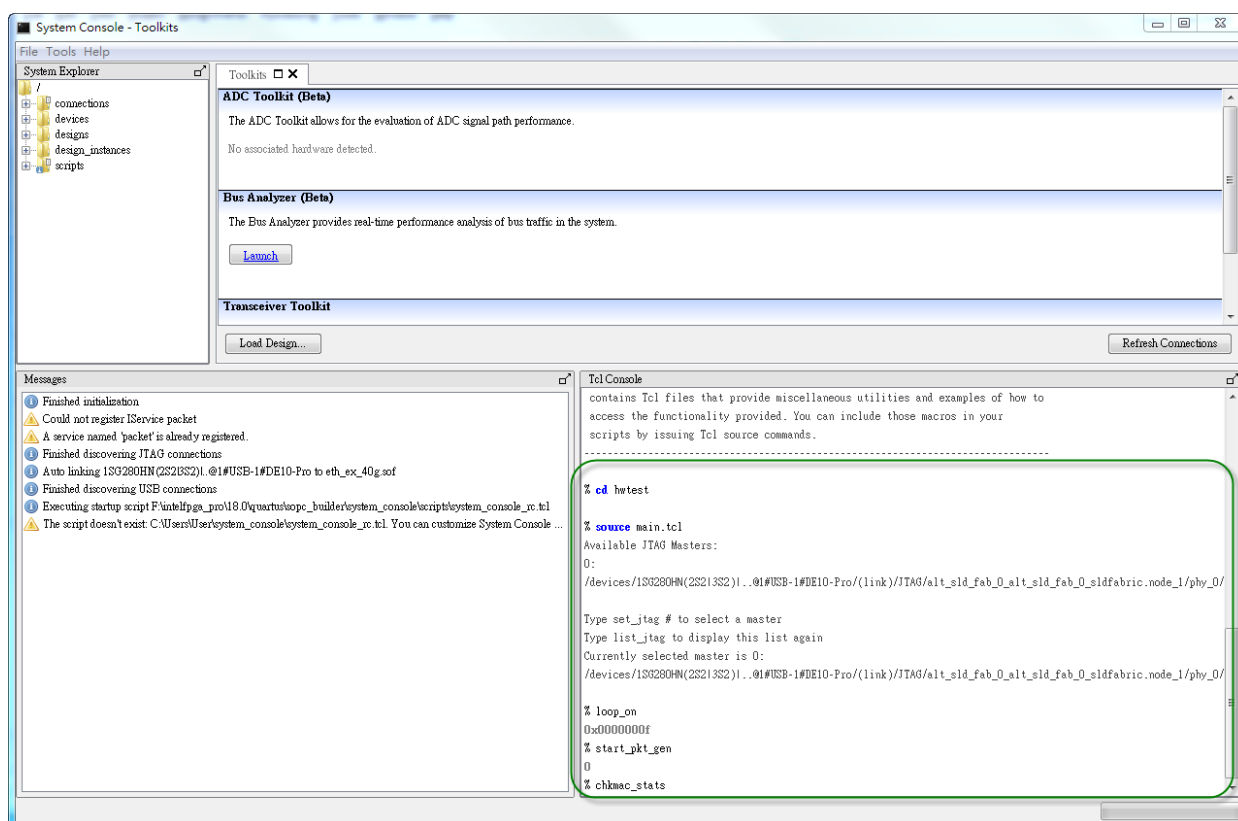

Figure 9-11 Launch the System Console for Ethernet 40G Demo

```

=====
                        STATISTICS FOR BASE 0x0900 (Rx)
=====
Fragmented Frames      : 0
Jabbered Frames       : 0
Any Size with FCS Err Frame : 0
Right Size with FCS Err Fra : 0
Multicast data Err Frames : 0
Broadcast data Err Frames : 0
Unicast data Err Frames : 0
Multicast control Err Frame : 0
Broadcast control Err Frame : 0
Unicast control Err Frames : 0
Pause control Err Frames : 0
64 Byte Frames        : 255635
65 - 127 Byte Frames  : 246562
128 - 255 Byte Frames : 501573
256 - 511 Byte Frames : 1003622
512 - 1023 Byte Frames : 2007885
1024 - 1518 Byte Frames : 1942409
1519 - MAX Byte Frames : 58317141
> MAX Byte Frames     : 0
Rx Frame Starts       : 0
Multicast data OK Frame : 0
Broadcast data OK Frame : 0
Unicast data OK Frames : 64274827
Multicast Control Frames : 0
Broadcast Control Frames : 0
Unicast Control Frames  : 0
Pause Control Frames    : 0
Payload Octets OK      : 435121033409
Frame Octets OK        : 436277980295

```

Figure 9-12 Ethernet 40G loopback test report for RX

```

=====
                        STATISTICS FOR BASE 0x0800 (Tx)
=====
Fragmented Frames      : 0
Jabbered Frames        : 0
Any Size with FCS Err Frame : 0
Right Size with FCS Err Fra : 0
Multicast data Err Frames : 0
Broadcast data Err Frames : 0
Unicast data Err Frames  : 0
Multicast control Err Frame : 0
Broadcast control Err Frame : 0
Unicast control Err Frames : 0
Pause control Err Frames  : 0
64 Byte Frames         : 255844
65 - 127 Byte Frames   : 246774
128 - 255 Byte Frames  : 502008
256 - 511 Byte Frames  : 1004549
512 - 1023 Byte Frames : 2009732
1024 - 1518 Byte Frames : 1944111
1519 - MAX Byte Frames : 58369696
> MAX Byte Frames     : 0
Tx Frame Starts        : 0
Multicast data OK Frame : 0
Broadcast data OK Frame : 0
Unicast data OK Frames  : 64332714
Multicast Control Frames : 0
Broadcast Control Frames : 0
Unicast Control Frames  : 0
Pause Control Frames    : 0
Payload Octets OK      : 435513588656
Frame Octets OK        : 436671577508

```

Figure 9-13 Ethernet 40G loopback test report for TX

Chapter 10

Additional Information

10.1 Getting Help

Here are the addresses where you can get help if you encounter problems:

■ Terasic Technologies

9F., No.176, Sec.2, Gongdao 5th Rd,
East Dist, HsinChu City, Taiwan, 30070

Email: support@terasic.com

Web: www.terasic.com

DE10-Pro Web: de10-pro.terasic.com

■ Revision History

Date	Version	Changes
2018.02	First publication	
2018.08.23	V1.0	Modify Figure 2-11
2018.09.04	V1.1	Modify Figure 2-11, modify 2x5 GPIO Header description in Page 18
2018.11.29	V1.2	Modify section 9.3
2019.01.23	V1.3	Add 1650 device
2019.02.14	V1.4	Modify section 9.3 for adding 100G test code