

EC35A 35mm Size Ring Type

A low-profile unit with 4.5mm height and good operation feel

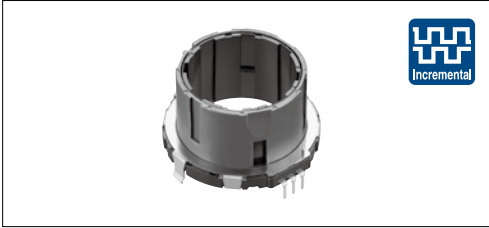

Encoders



Typical Specifications

Items	Specifications
Rating	10mA 5V DC
Operating life	50,000 cycles
Operating temperature range	-40°C to +85°C

Product Line

Actuator length (mm)	Detent torque (mN·m)	Number of detent	Number of pulse	Minimum order unit (pcs.)		Product No.	Drawing No.
				Japan	Export		
20	18±7	30	15	420	840	EC35A1520402	1
20	22±8	18	9			EC35A0930401	2
25	30±15	30	15	350	700	EC35A1550502	3

Packing Specifications

Tray

Actuator length (mm)	Number of packages (pcs.)		Export package measurements (mm)
	1 case /Japan	1 case /export packing	
20	420	840	540×360×380
25	350	700	

Dimensions

Unit:mm

No.	Photo	Style	PC board mounting hole dimensions (Viewed from mounting side)
1	<p>EC35A1520402 Actuator length 20mm</p>		<p>Shaded area: Wiring prohibited area</p>
2	<p>EC35A0930401 Actuator length 20mm</p>		<p>Shaded area: Wiring prohibited area</p>

■ Dimensions

Unit:mm

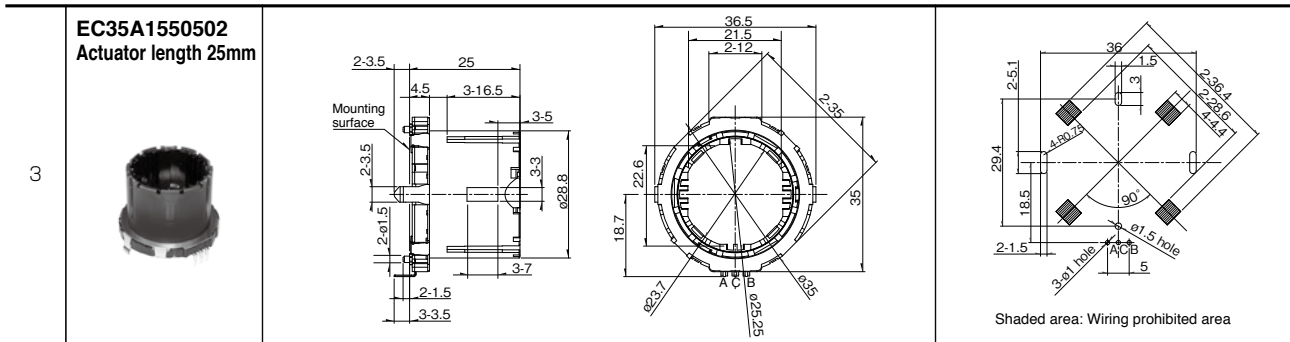



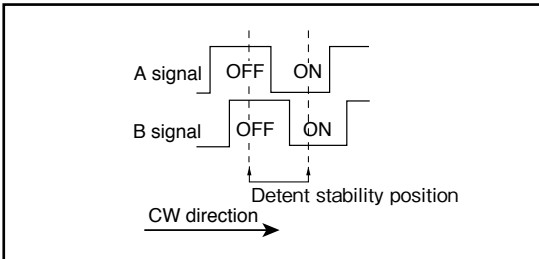



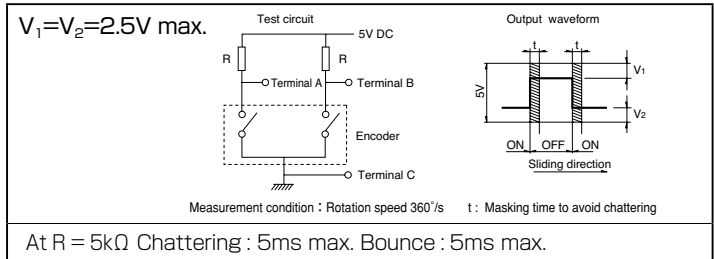



■ Output Wave



■ Sliding Noise



Type		Ring type				
		28mm size		35mm size		
Series		EC28A	EC28C	EC35A	EC35AH	EC35CH
Photo						
Output		Incremental (Two phase A and B)			Incremental (Three phase A, B and C)	
Shaft types		Ring type				
Number of pulse / Number of detent		15/30 18/18	15/30	9/18 15/30	6×ABC/18 10×ABC/30	6×ABC/18
Dimensions (mm)	W	28		35		35.2
	D	29	29.5			36
	H	4		4.5		
Operating temperature range		-40°C to +85°C	-40°C to +90°C	-40°C to +85°C		-40°C to +90°C
Operating life		50,000 cycles				
Automotive use		●	●	●	●	●
Life cycle (availability)						
Electrical performance	Rating	10mA 5V DC				
	Max./min. operating current (Resistive load)	10mA /1mA				
	Insulation resistance	100MΩ min. 250V DC				
	Voltage proof	300V AC for 1minute or 360V AC for 2s	300V AC for 1minute or 360V AC for 1s	300V AC for 1minute or 360V AC for 2s		300V AC for 1minute or 360V AC for 1s
Mechanical performance	Detent torque	7±5mN·m 12±7mN·m 20±10mN·m	22±11mN·m (Initial) 16±7mN·m (After reflow) 30±15mN·m (Initial) 20±10mN·m (After reflow)	18±7mN·m 22±8mN·m 30±15mN·m	12±5mN·m 18±7mN·m 30±15mN·m	30±15mN·m (Initial) 20±10mN·m (After reflow)
	Push-pull strength	100N				
Shaft configuration		Ring type				
Terminal type		Insertion				
Switch Specifications	Switch type	—	—	—	—	—
	Contact arrangement	—	—	—	—	—
	Travel (mm)	—	—	—	—	—
	Operating force (N)	—	—	—	—	—
	Switch ON position	—	—	—	—	—
	Rotational torque	—	—	—	—	—
	Rating	—	—	—	—	—
	Contact resistance	—	—	—	—	—
	Operating life	—	—	—	—	—
Page		288		290	292	

Encoders Soldering Conditions 299
 Encoders Cautions 300

Note

● Indicates applicability to all products in the series.

Reference for Manual Soldering

Series	Tip temperature	Soldering time	No. of solders
EC05E, EC09E, EC10E, EC111, EC11B, EC11E, EC11G, EC11K, EC11M, EC11N, EC12D, EC12E, EC18A, EC21A, EC28A, EC35A, EC35AH, EC40A, EC45A, EC50A, EC60B, EM11B, EC21C, EC28C, EC35CH	350°C max.	3s max.	1 time
EC11J	350±10°C	3 ⁺¹ ₀ s	2 times

Reference for Dip Soldering

Series	Preheating		Dip soldering		No. of solders
	Soldering surface temperature	Heating time	Soldering temperature	Soldering time	
EC09E, EC11B, EC111, EC11E, EC11G, EC11K, EC11M, EC11N, EC18A, EC21A, EC28A, EC35A, EC35AH, EC50A, EC60B	100°C max.	2 min. max.	260±5°C	5±1s	2 times max.
EM11B	100°C max.	1 min. max.	260°C max.	3s max.	2 times max.
EC10E, EC12D, EC12E	100°C max.	1 min. max.	260±5°C	3±1s	2 times max.
EC40A	110°C max.	1 min. max.	260°C max.	10s max.	1 time
EC45A	100°C max.	2 min. max.	260°C max.	5s max.	2 times max.

Example of Reflow Soldering Condition

Temperature profile

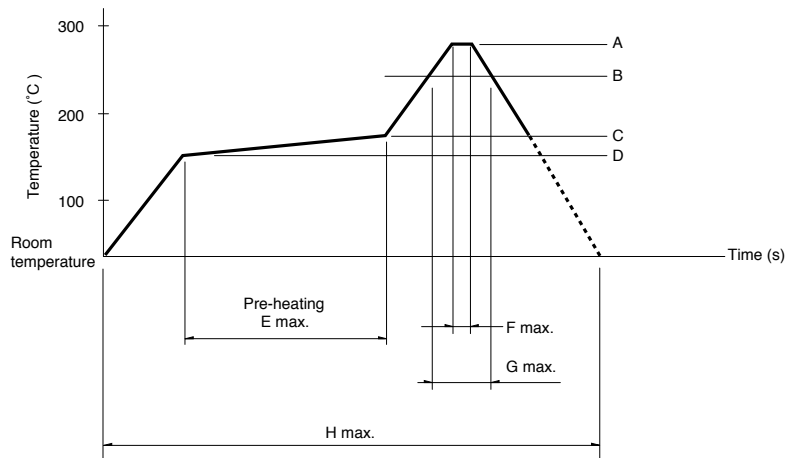

Series	A	B	C	D	E	F	G	H	No. of reflows
EC11J	260°C	230°C	180°C	150°C	2 min. max.	3s	40s	4 min. max.	2 times max.
EC05E	250°C min.	230°C min.	180°C	150°C	60s to 120s	—	30s to 40s	—	2 times max.
EC21C	230°C to 245°C	220°C	200°C	150°C	60s to 120s	—	25s to 60s	300s max.	1 time max.
EC28C, EC35CH	260°C	230°C	180°C	150°C	2 min. min.	3s	40s	230s max.	1 time max.

Notes

- When using an infrared reflow oven, solder may sometimes not be applied. Be sure to use a hot air reflow oven or a type that uses infrared rays in combination with hot air.
- The temperatures given above are the maximum temperatures at the terminals of the encoder when employing a hot air reflow method. The temperature of the PC board and the surface temperature of the encoder may vary greatly depending on the PC board material, its size and thickness. Ensure that the surface temperature of the encoder does not rise to 250°C or greater.
- Conditions vary to some extent depending on the type of reflow bath used. Be sure to give due consideration to this prior to use.