

V4 8318 Sealed High-current 83180 Part number made to order



- IP 67 protection
- Nominal ratings 0.1 A to 10 A / 250 VAC
- Minimum rating 1 mA / 4 VDC
- Operating temperature -40 °C to +125 °C
- Choice of actuators with 2 possible fixing positions

Part numbers

	Type	Function	Connections
MADE TO ORDER	High-current 83180	I (changeover)	W2S

Specifications

Electrical characteristics

Rating nominal / 250 VAC (A)	10
Rating thermal / 250 VAC (A)	12,5

Mechanical characteristics

Maximum operating force (N)	3,4
Min. Release force (N)	1
Maximum total travel force (N)	5
Max. permitted overtravel force (N)	10
Maximum rest position (mm)	9,3
Operating position (mm)	8,4 ±0,3
Maximum differential travel (mm)	0,1
Min. overtravel (mm)	0,6
Ambient operating temperature for blade version (°C)	-40 → +125
Ambient operating temperature for wires/cable version (°C)	-40 → +105
Mechanical life (operations)	10 ⁶
Contact gap (mm)	0,4
Weight (g) (tags version)	2

Comments

* Type 83180 available on request

** Cable version for types 83181, 83183 and 83186

Additional specifications

Components

Material

- Case : polyester UL 94VO
- Button : polyester
- Membrane : silicon
- Contacts : AgCdO or AgSnO₂ gold-plated AgNi (dual-current)
- Terminals : silver-plated, tinned brass
- Cable/Lead : PVC

Levers

- Flat : stainless steel
- Roller : stainless steel, polyamide roller

Principles

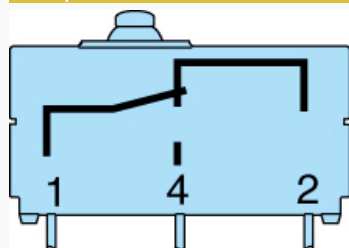

Dimensions (mm)

Product

Symmetrical version
types 83180 / 181 / 183 / 186

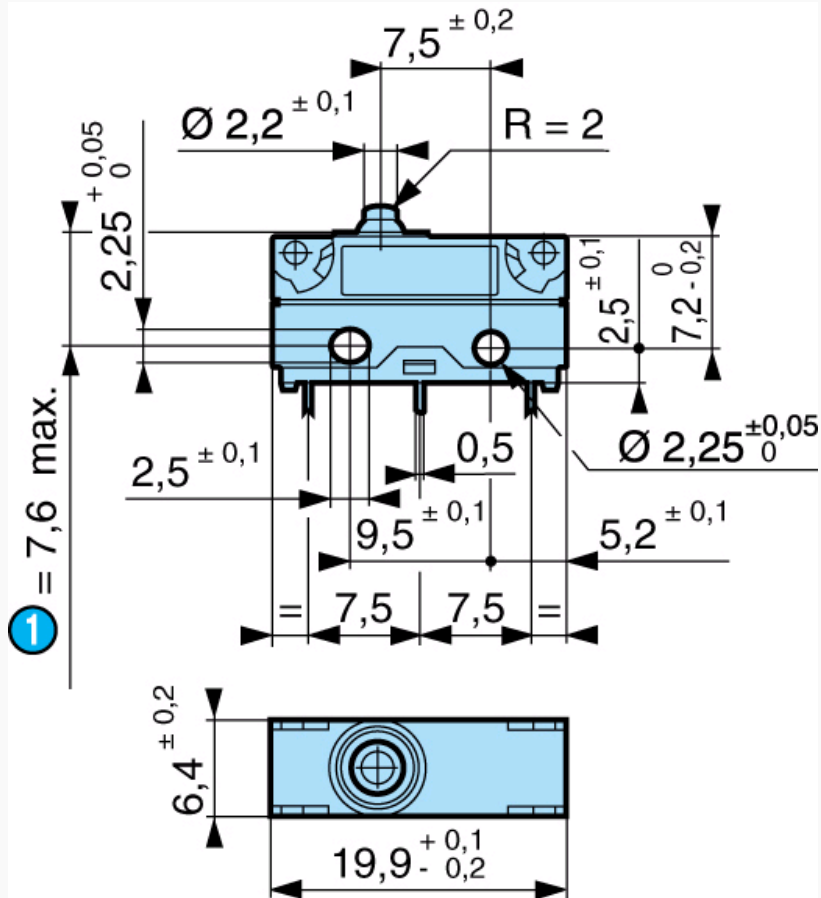

N°	Legend
1	OL = 7.6 max.

Dimensions (mm)

Product

Asymmetrical version
types 83180 / 181 / 183 / 186

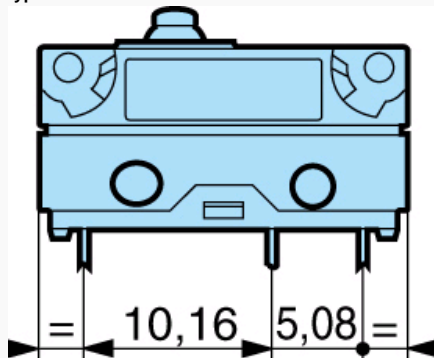

Fixed by 2 M2 screws Torque with screw only : 0.2 Nm, with screw + washer : 0.3 Nm

Dimensions (mm)

Connections

W2S
Solder

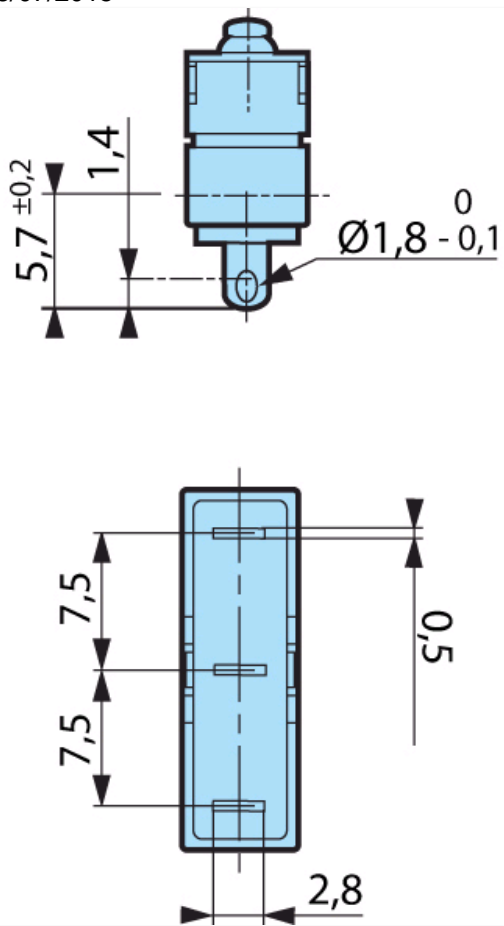

Fixed by 2 M2 screws Torque with screw only : 0.2 Nm, with screw + washer : 0.3 Nm

Dimensions (mm)

Connections

W7S

Faston 2.8 x 0.5

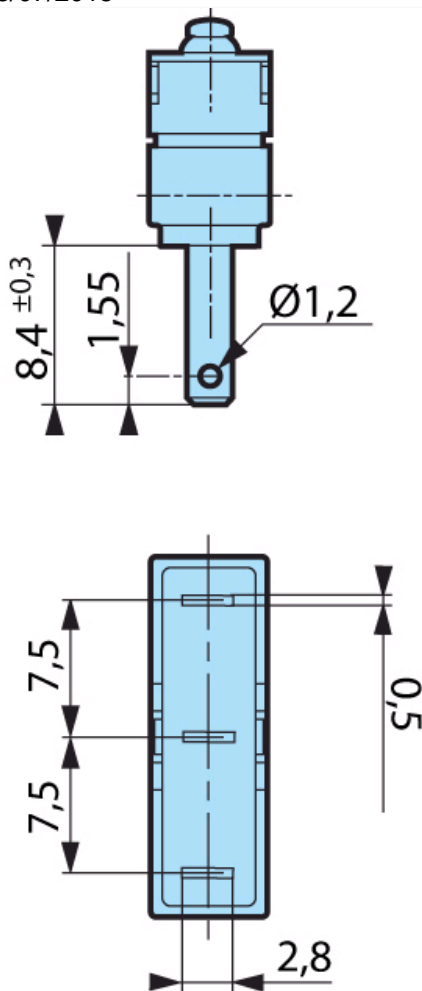

Fixed by 2 M2 screws Torque with screw only : 0.2 Nm, with screw + washer : 0.3 Nm

Dimensions (mm)

Connections

X1A
Straight PCB output

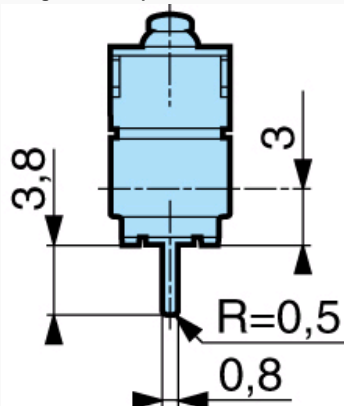

Fixed by 2 M2 screws Torque with screw only : 0.2 Nm, with screw + washer : 0.3 Nm

Dimensions (mm)

Connections

X1S
Straight PCB output

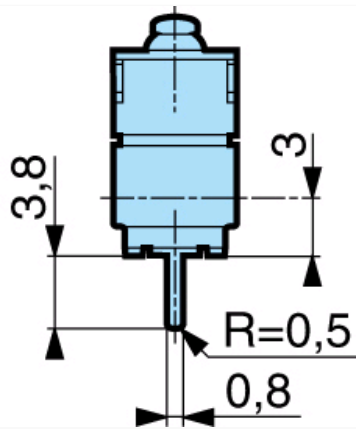

Fixed by 2 M2 screws Torque with screw only : 0.2 Nm, with screw + washer : 0.3 Nm

Dimensions (mm)

Connections

X2A - X2S

Side outputs, PCB rear

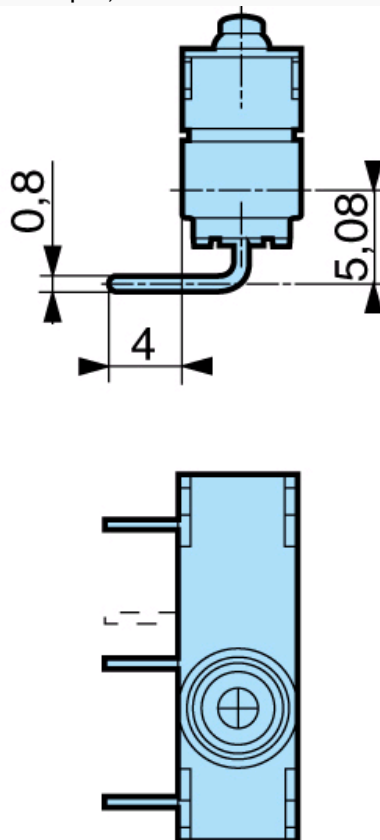

Fixed by 2 M2 screws Torque with screw only : 0.2 Nm, with screw + washer : 0.3 Nm

Dimensions (mm)

Connections

X3A - X3S

Side outputs, PCB front

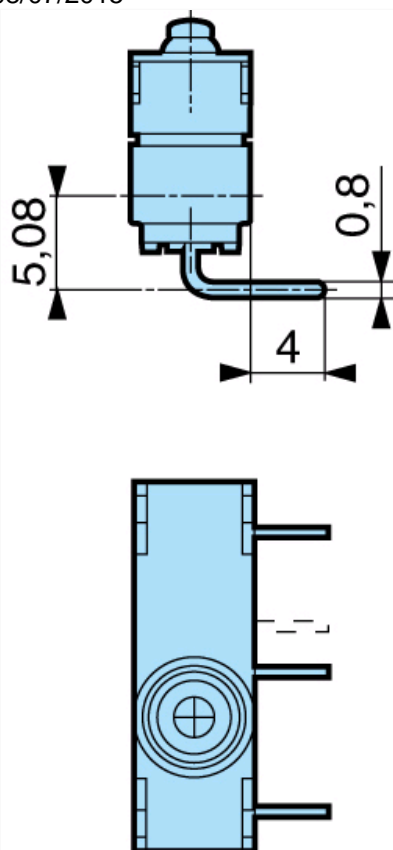

Fixed by 2 M2 screws Torque with screw only : 0.2 Nm, with screw + washer : 0.3 Nm

Dimensions (mm)

Drilling

Printed circuit board mounting
Asymmetrical
X1A, X2A, X3A

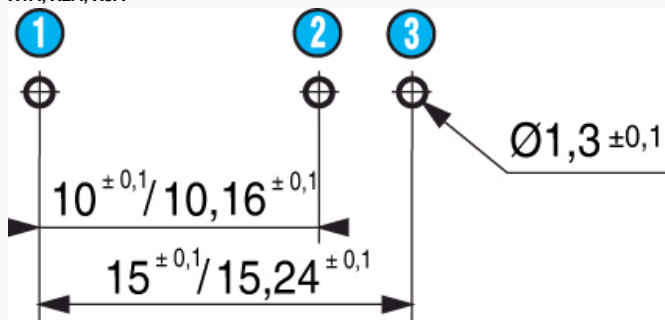

Fixed by 2 M2 screws Torque with screw only : 0.2 Nm, with screw + washer : 0.3 Nm

N°	Legend
1	1.C
2	4.NO
3	2.NC

Dimensions (mm)

Drilling

Printed circuit board mounting
Symmetrical
X1S, X2S, X3S

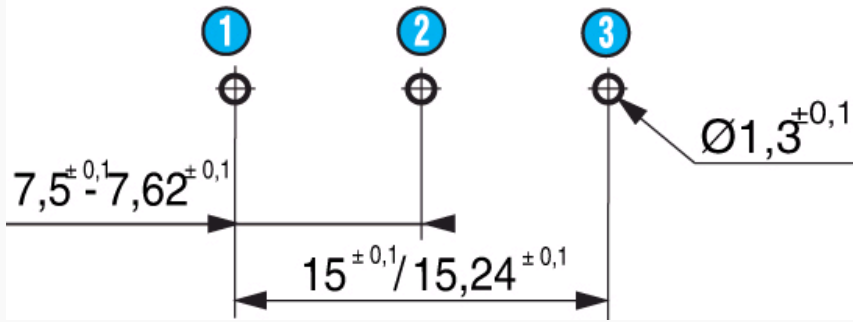

Fixed by 2 M2 screws Torque with screw only : 0.2 Nm, with screw + washer : 0.3 Nm

N°	Legend
1	1.C
2	4.NO
3	2.NC

Dimensions (mm)

Drilling

Mounting on a printed circuit board with fixing pins
Asymmetrical

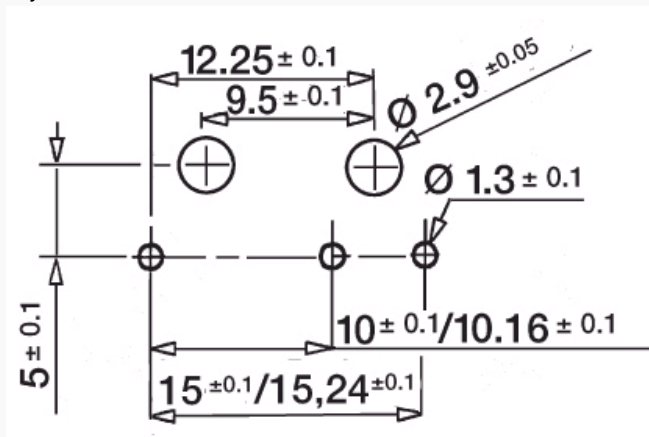

Fixed by 2 M2 screws Torque with screw only : 0.2 Nm, with screw + washer : 0.3 Nm

Dimensions (mm)

Drilling

Mounting on a printed circuit board with fixing pins
Symmetrical

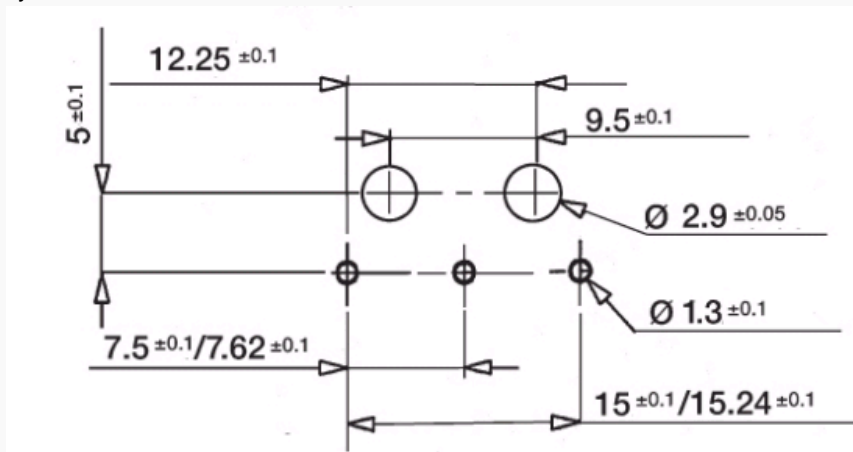

Fixed by 2 M2 screws Torque with screw only : 0.2 Nm, with screw + washer : 0.3 Nm

Dimensions (mm)

Connections

Lead outputs

FG0 lead output on left - FD0 lead output on right

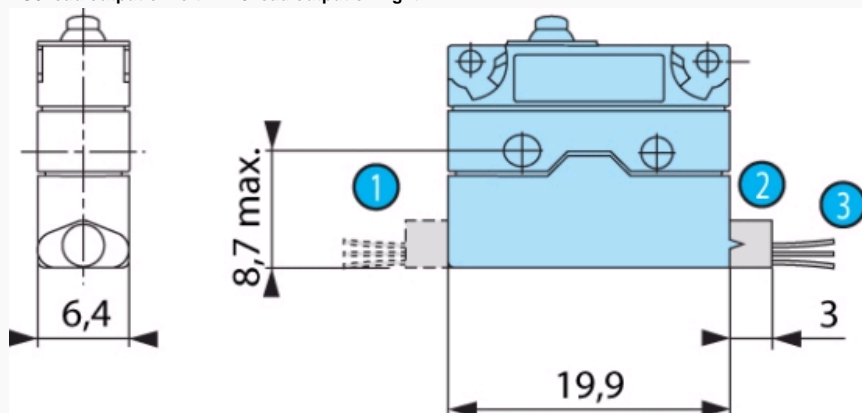
Black = Common Grey = NC Blue = NO Conductor cross-section : 83181 / 83183 / 83186 = 0.5 mm² 83180 = 0.75 mm²

N°	Legend
1	FG0
2	FD0
3	Standard 500 mm

Dimensions (mm)

Connections

Lead/cable output

CB0 cable output on bottom

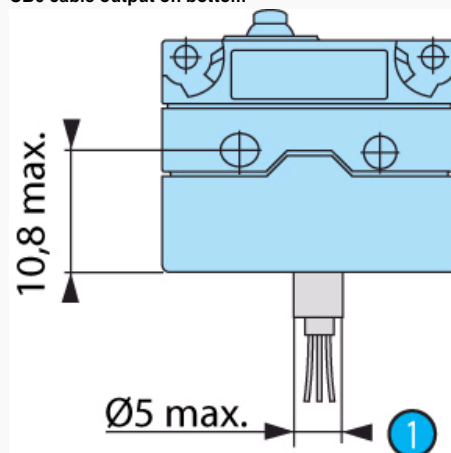
Black = Common Grey = NC Blue = NO Conductor cross-section : 83181 / 83183 / 83186 = 0.5 mm² 83180 = 0.75 mm²

N°	Legend
1	Standard 500 mm

Dimensions (mm)

Connections

Cable outputs

CG0 cable output on left - CD0 cable output on right

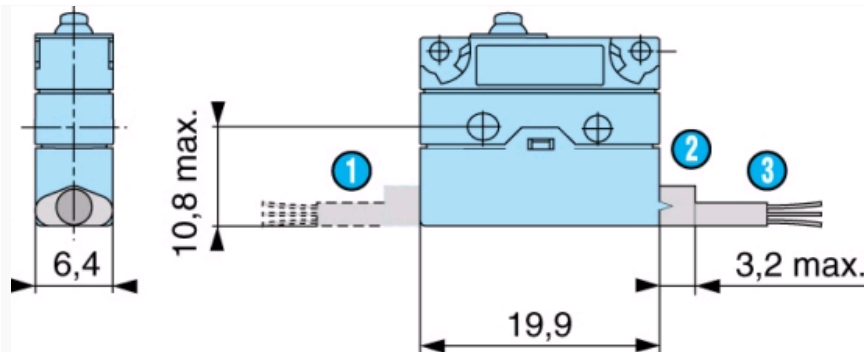

Black = Common Grey = NC Blue = NO Conductor cross-section : 83181 / 83183 / 83186 = 3 x 0,5 mm²

N°	Legend
①	CG0
②	CD0
③	Standard 500 mm

Dimensions (mm)

Actuator mounting positions

Fixing position

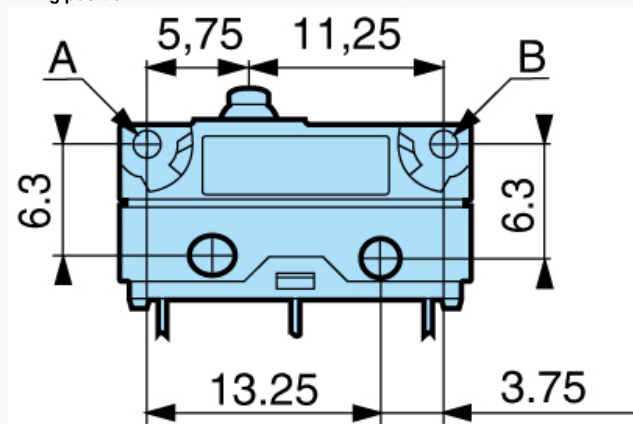

Black = Common Grey = NC Blue = NO Conductor cross-section : 83181 / 83183 / 83186 = 3 x 0,5 mm²

Dimensions (mm)

Actuators

170 A
Flat

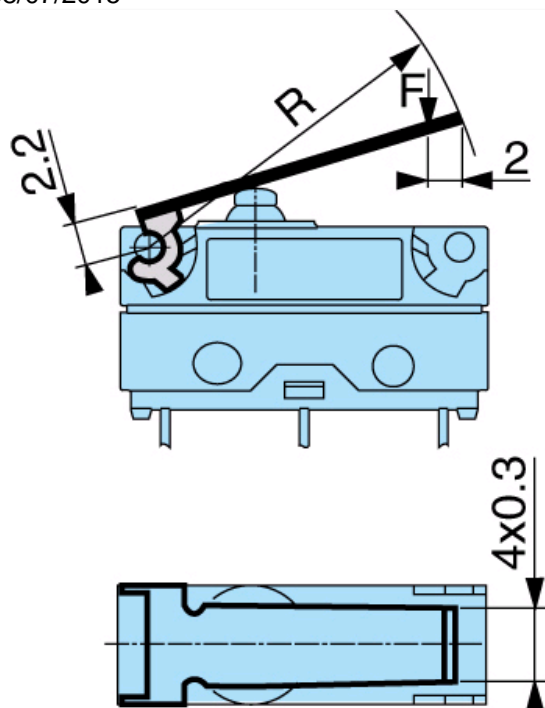

Black = Common Grey = NC Blue = NO Conductor cross-section : 83181 / 83183 / 83186 = 3 x 0.5 mm²

Dimensions (mm)

Actuators

170 E
Roller

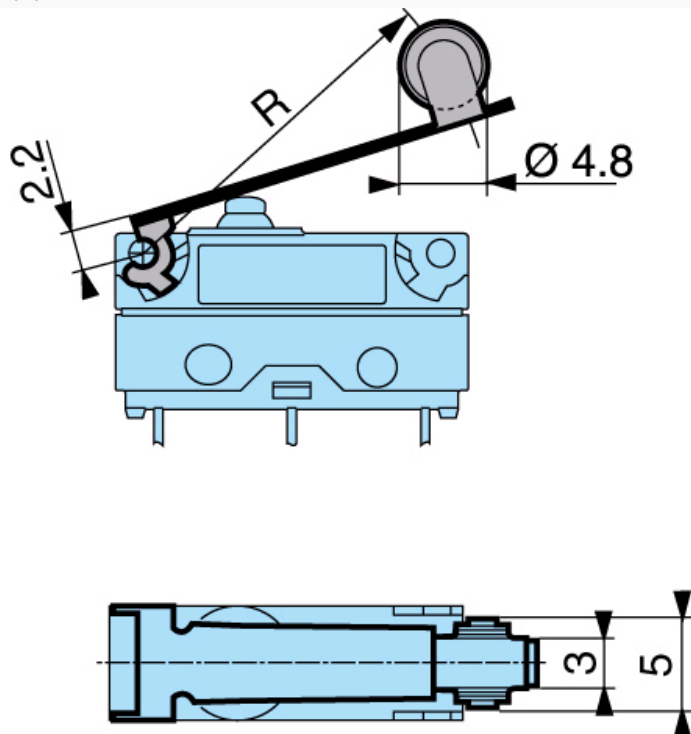

Black = Common Grey = NC Blue = NO Conductor cross-section : 83181 / 83183 / 83186 = 3 x 0.5 mm²

Dimensions (mm)

Actuators

170 F
Dummy roller

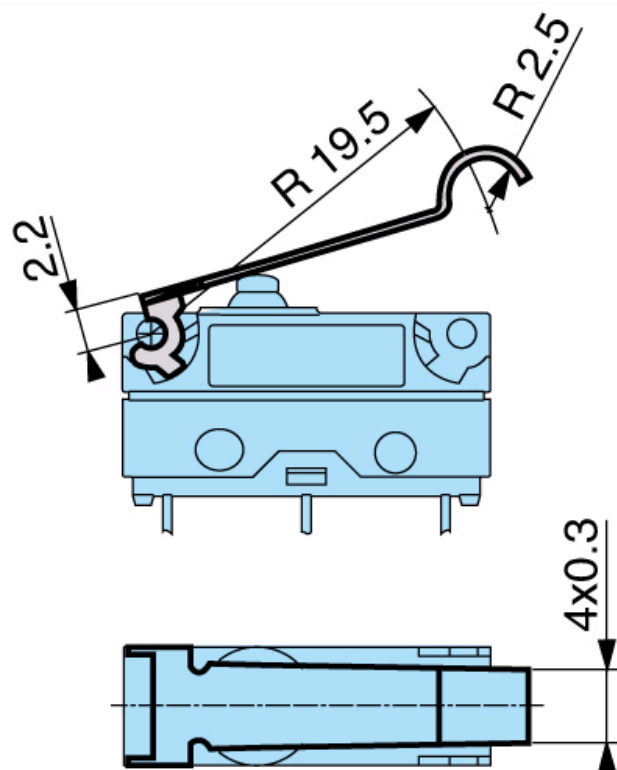

Black = Common Grey = NC Blue = NO Conductor cross-section : 83181 / 83183 / 83186 = 3 x 0.5 mm²

Dimensions (mm)

Actuators

Recommendations for operation from the side

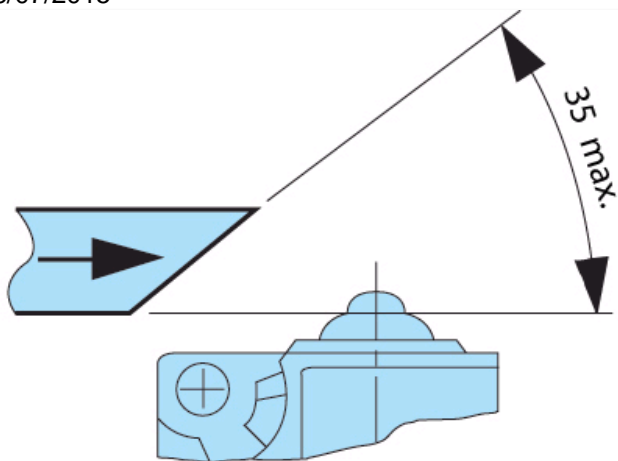

Black = Common Grey = NC Blue = NO Conductor cross-section : 83181 / 83183 / 83186 = 3 x 0.5 mm²

Dimensions (mm)

Mounting accessories

Fixing pins

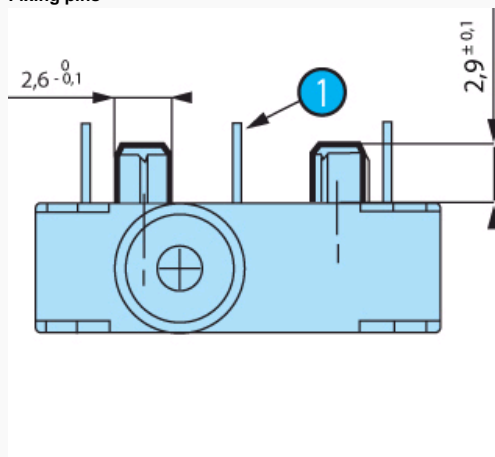

Black = Common Grey = NC Blue = NO Conductor cross-section : 83181 / 83183 / 83186 = 3 x 0.5 mm²

N°	Legend
①	X2 output

Dimensions (mm)

Mounting accessories

Fixing pins

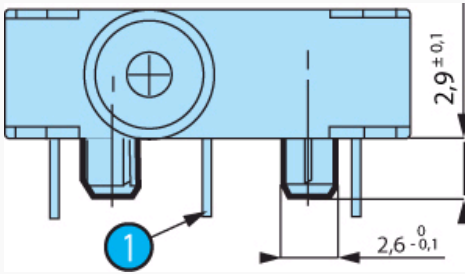

Black = Common Grey = NC Blue = NO Conductor cross-section : 83181 / 83183 / 83186 = 3 x 0.5 mm²

N°	Legend
1	X3 output

Curves

Operating curve 250 VAC

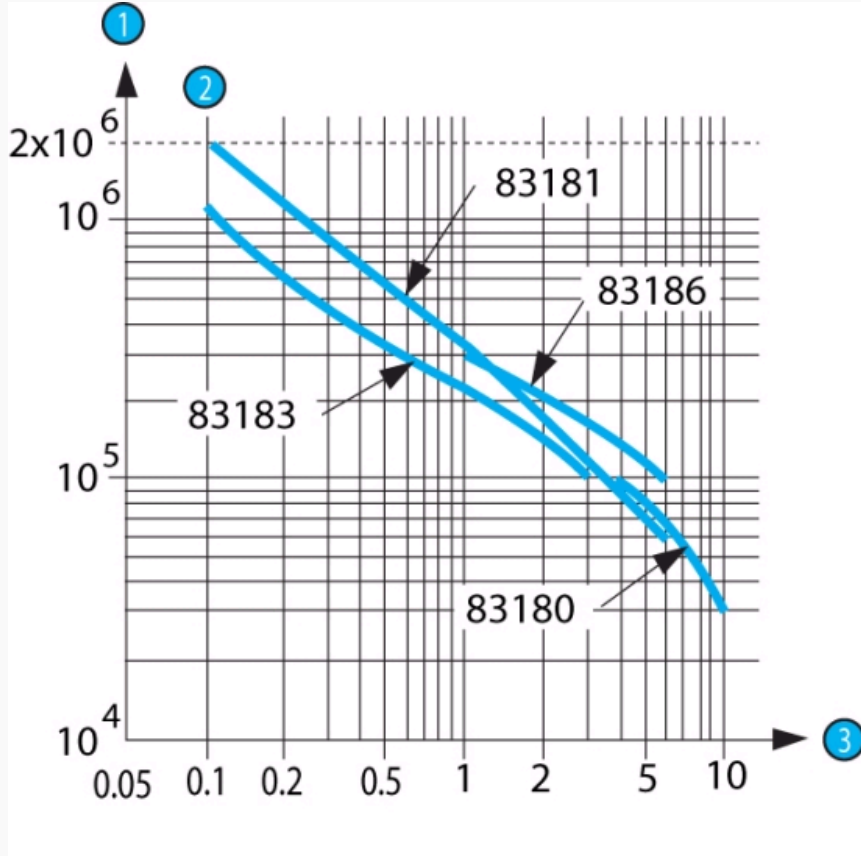

Model 83181 is designed to operate equally well on dual-current (1 mA 4 V minimum) or medium-current (6 A maximum) circuits. However, a given product should only be used to switch one type of circuit during its working life.

N°	Legend
1	Number of cycles
2	Resistive circuit
3	Current in Amps

Curves







Switch rating with DC supply

		83180	83181	83183	83186
12 V	Resistive	10 A	6 A	3 A	6 A
	Inductive L/R 5 ms	10 A	6 A	3 A	6 A
24 V	Resistive	10 A	6 A	3 A	6 A
	Inductive L/R 5 ms	5 A	5 A	3 A	5 A

Model 83181 is designed to operate equally well on dual-current (1 mA 4 V minimum) or medium-current (6 A maximum) circuits. However, a given product should only be used to switch one type of circuit during its working life.

Connections

Actuators and fixing positions

Part numbers for standard actuators		79253327		79253326		79218454	
Actuators		Flat 170A R18.3	Flat 170A R24	Flat 170A R41	Roller 170E R20		
							
Mounting position		A B	A B	A B	A B	A B	
Coefficient		3 1.5	4 2	7 3.5	3 1.5		
Tripping point		10 ^{+1.4} 9.2 ^{+0.9}	10.7 ^{+1.7} 9.6 ^{+1.1}	12.7 ^{+1.3} 10.6 ^{+1.8}	15.5 ^{+1.4} 14.5 ^{+1.0}		
83180				11 ^{+1.1} 8.8 ^{+1.6}			
83181 / 183 / 186				11.4 ^{+1.1} 9.3 ^{+1.6}			
Part numbers for standard actuators		79253329					
Actuators		Dummy roller 170F R19.5	Screw 170D *	Transverse roller 170 EL *			
							
Mounting position		A B					
Coefficient		3 1.5					
Tripping point		12.9 ^{+1.3} 11.9 ^{+1.7}					

Except where otherwise indicated, levers are supplied unmounted.

For factory mounting, specify fixing position A or B.

* To special order

Other information

Mounting - Operation

See basic technical concepts

Degree of protection

- Tag version :

→ casing = IP67

→ terminals = IP00

- Lead/cable version :

→ output/casing = IP67

To calculate force : divide the switch force by the coefficient in the table.

To calculate travel : multiply the switch travel by the same coefficient.

Product adaptations



- Special levers
- Specific fixings
- Special leads, cables, cable harnesses
- NF - UL - cUL approvals