

SPECIFICATION

- Part No. : **SGGP.25.2.A.02**
- Description : GPS/GLONASS/GALILEO SMD Mount
Embedded Ceramic Patch Antenna
25*25*2mm
- Features : 3.34 dBi Peak Gain for GPS/GALILEO Band
3.32 dBi Peak Gain for GLONASS Band
25mm*25mm*2mm dimension
SMD direct mount ceramic patch antenna
Automotive TS16949 Production and
Quality Approved
RoHS compliant



Front



Back

1. Introduction

The SGGP.25.2.A.02 is an embedded SMD ceramic GPS/GLONASS/GALILEO passive patch antenna with a low profile of 2mm thickness. It is designed for applications such as

- navigation
- infotainment
- vehicle tracking/fleet management systems
- UAV
- telematics devices

where a high performance solution is needed in a low profile form factor

The antenna has been tuned to mount centrally a 50*50 mm ground plane, working at 1575.42MHz and 1602MHz, with a 3.34 dBi gain and 3.32 dBi gain, respectively. 70% efficiency is best in class. The ceramic patch is mounted via reflow process from a pick and place machine. The antenna itself is manufactured and tested in a TS16949 first tier automotive approved facility.

For further optimization to customer specific device environments where ground-plane size or mounting location is different, which can lead to detuning, a custom tuned patch antennas can be supplied, subject to NRE and MOQ. For more details please contact your regional Taoglas facility.

2. Specification

ELECTRICAL		
Application Bands	GPS/GALILEO	GLONASS
Operation Frequency (MHz)	1575.42 ±1.023	1602±5
Return Loss (dB)	< -10	
Gain at Zenith (dBi)	3.34	3.32
Efficiency (%)	67.41	67.94
Impedance	50 ohms	
MECHANICAL		
Ceramic Dimension (mm)	25*25*2	
Weight (g)	5.74	
ENVIRONMENTAL		
Operation Temperature	-40°C to 85°C	
Humidity	Non-condensing 65°C 95% RH	

* Antenna properties were measured with the antenna mounted on 50*50mm Ground Plane
Taoglas Part # SGGPD.25B

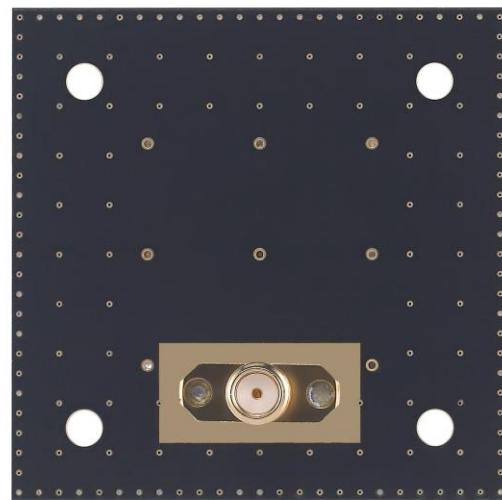

3. Antenna Characteristics

3.1. Return Loss

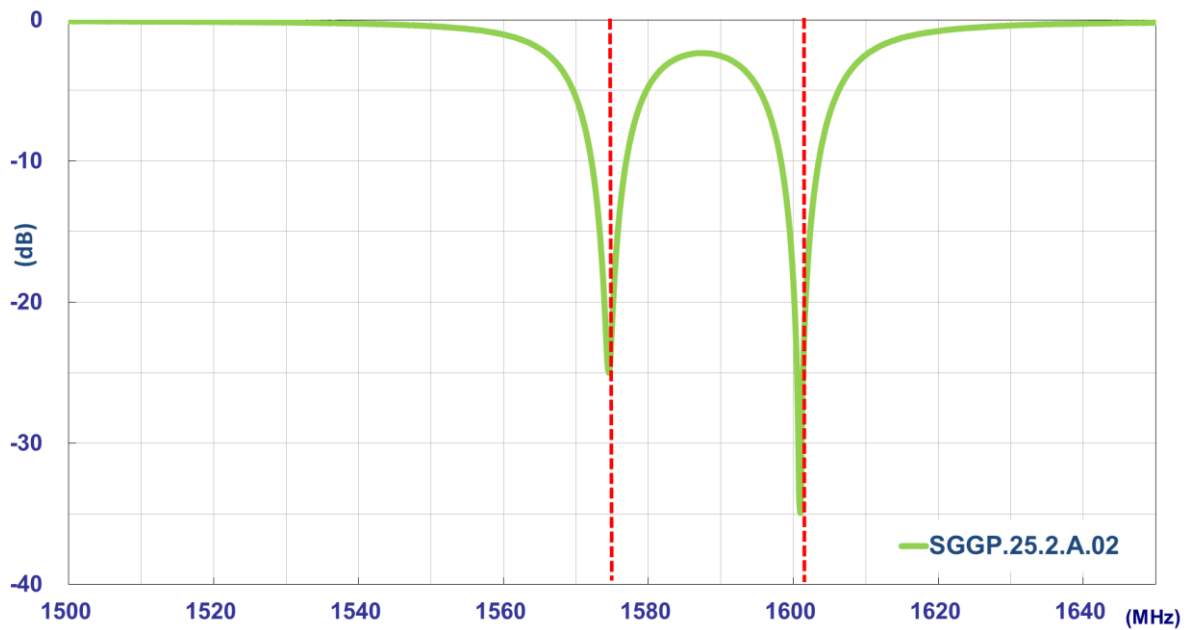

3.2. Efficiency

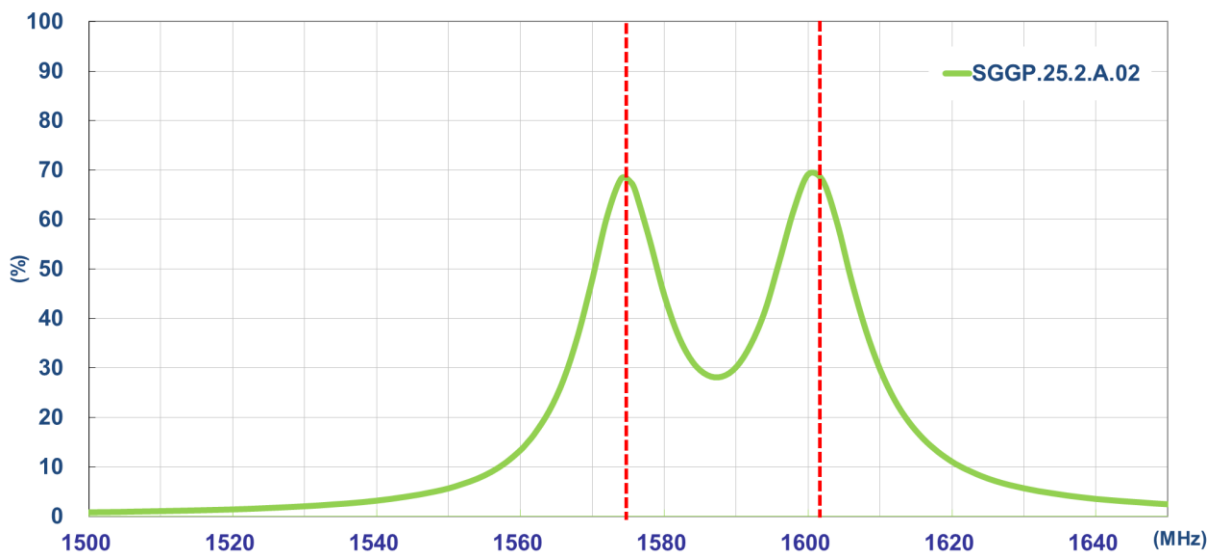

3.3. Average Gain

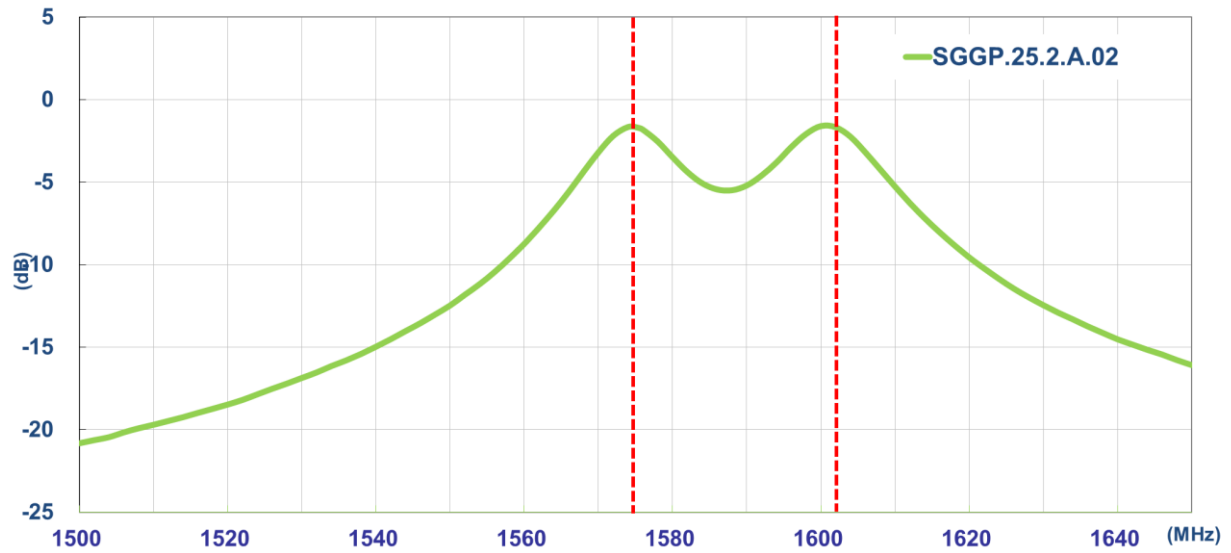

3.4. Peak Gain

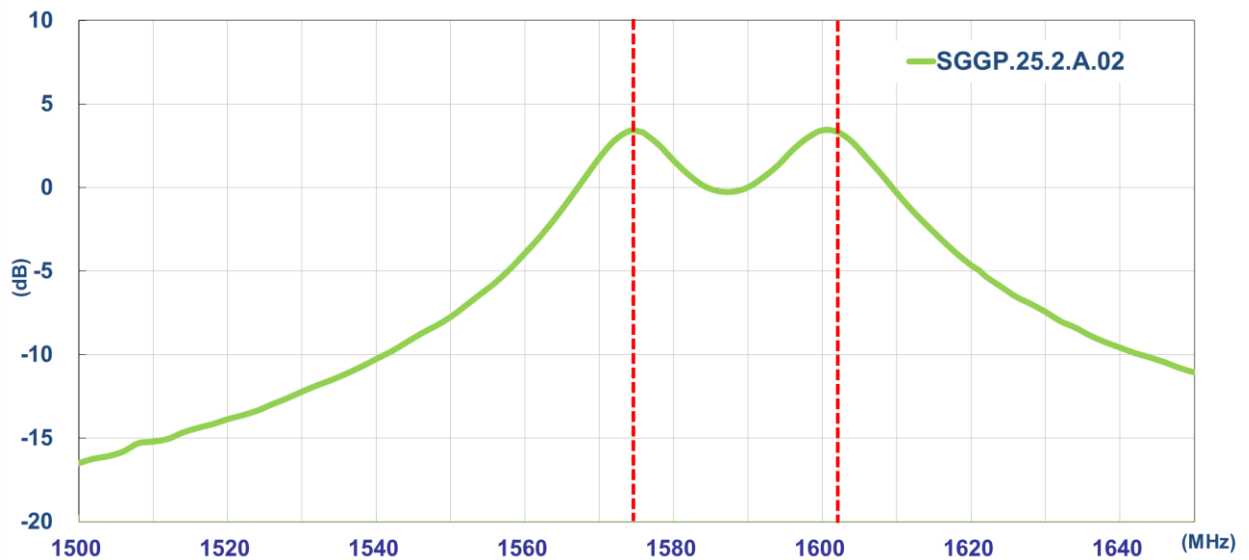

4. Antenna Radiation Pattern

4.1. Measurement Setup

The SGGP.25.2.A.02 antenna is tested with 50mm*50mm ground plane in a CTIA certified ETS-Lindgren Anechoic Chamber. The test setup is shown below.

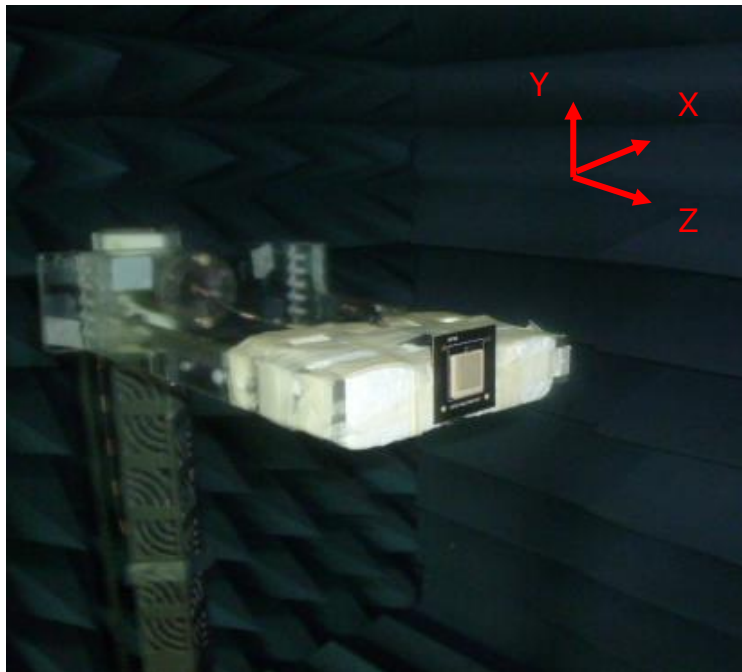

4.2. 2D Radiation Pattern

XY Plane

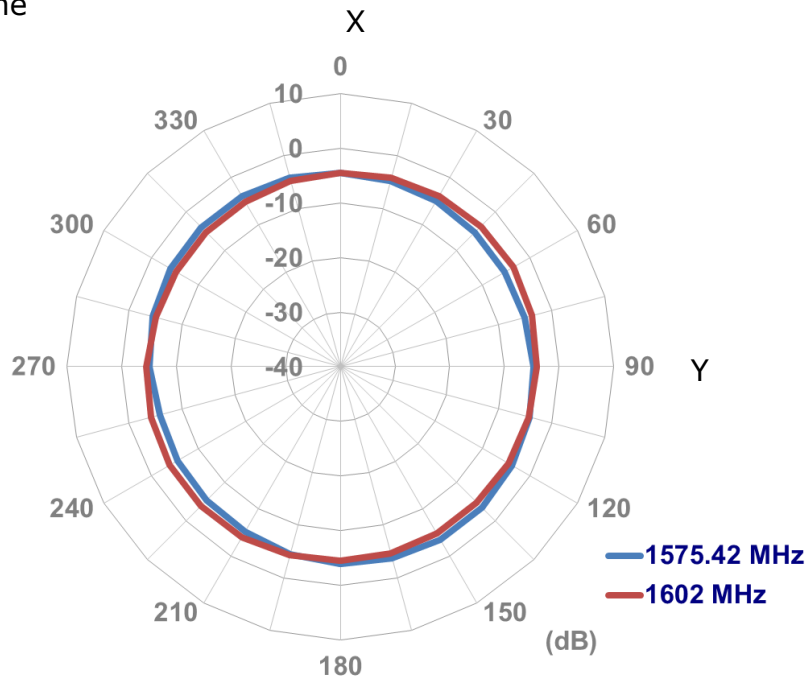

XZ Plane

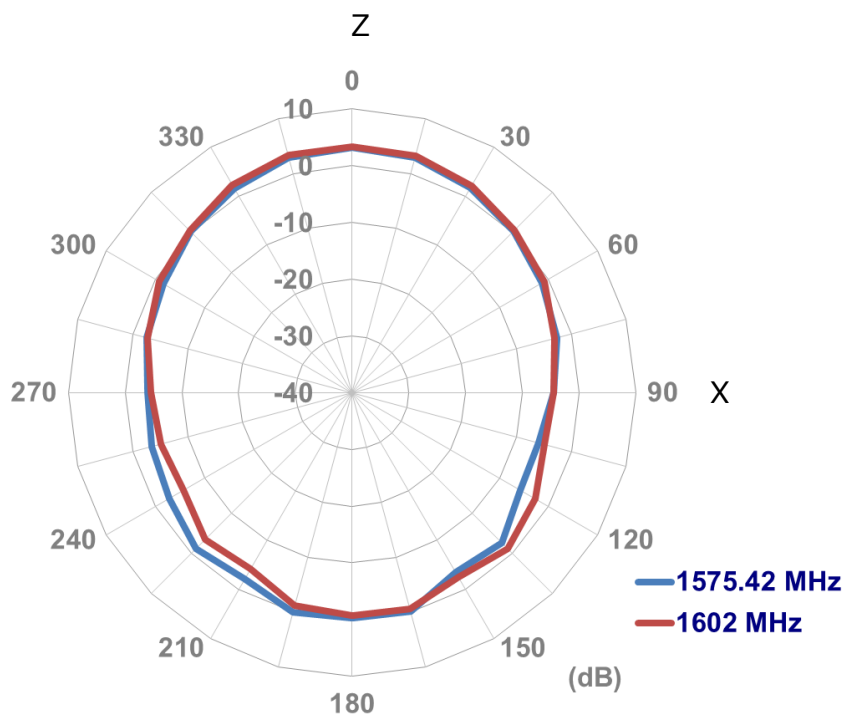

YZ Plane

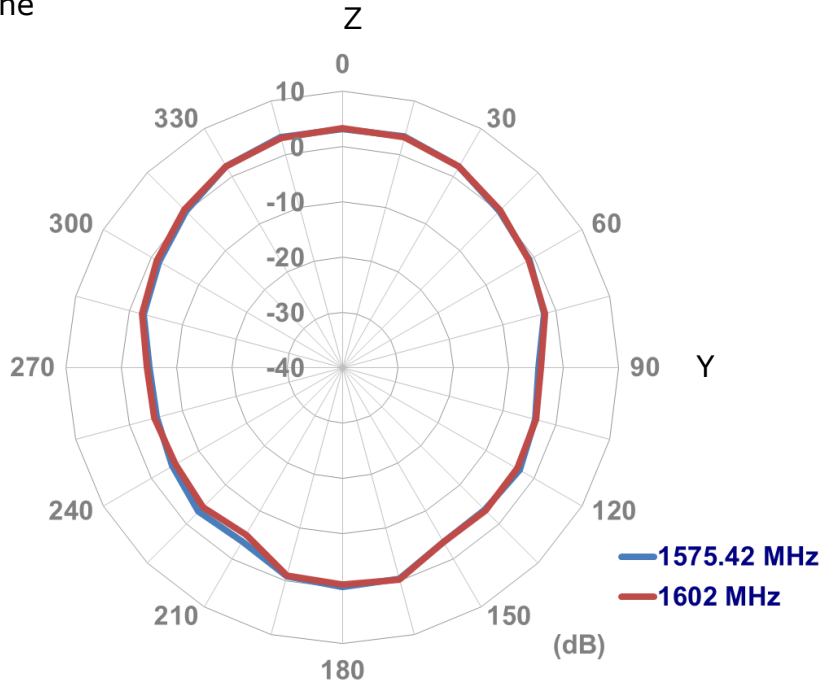

4.3. 3D Radiation Pattern

1575.42MHz

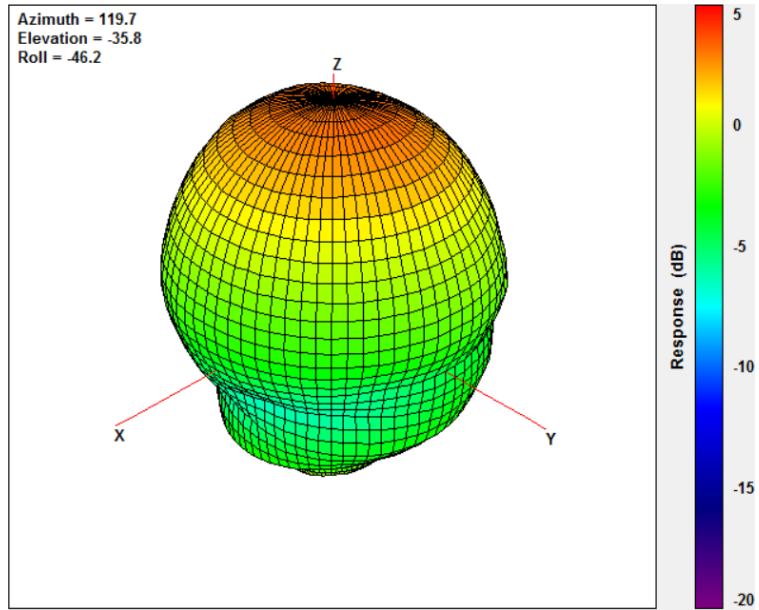

1602MHz

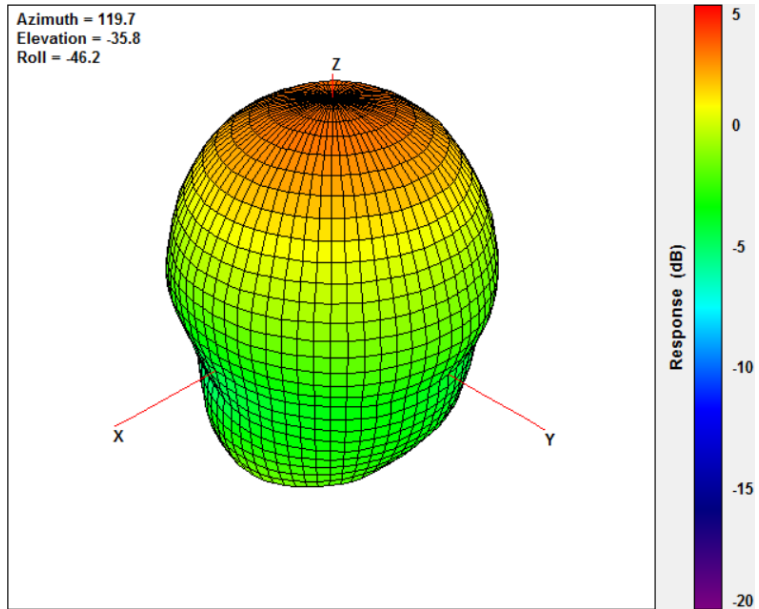

5. Mechanical Drawing

Top View

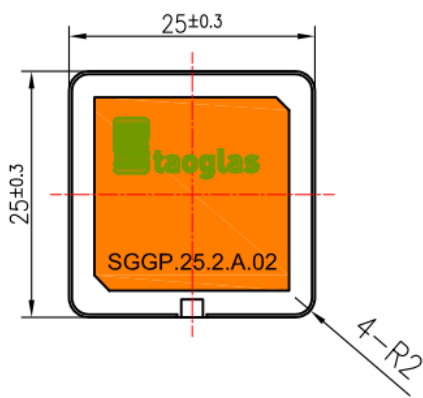

Side View

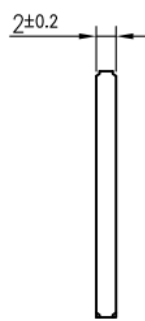

Bottom View

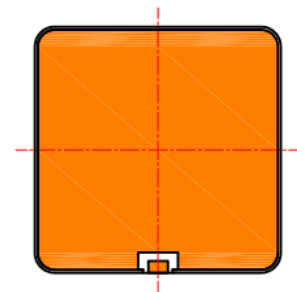

Unit:mm

6. Evaluation Board (SGGPD.25B)

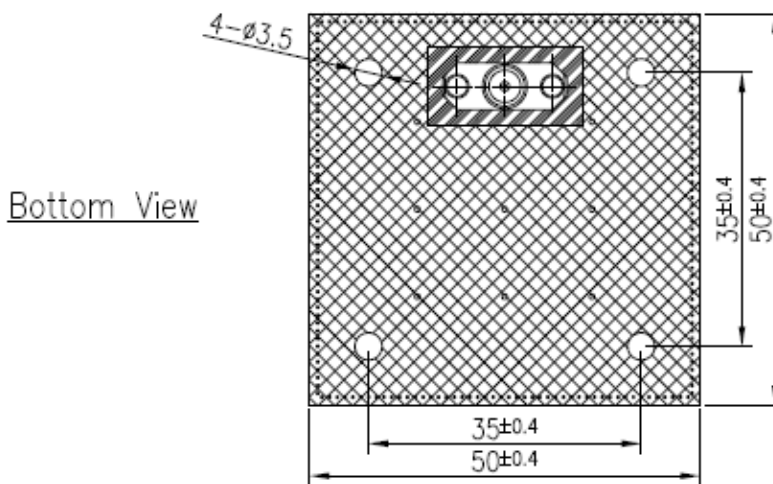
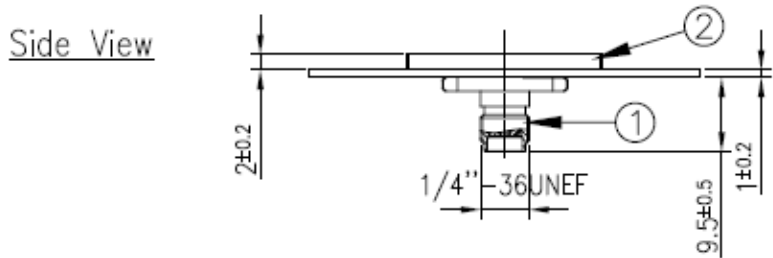
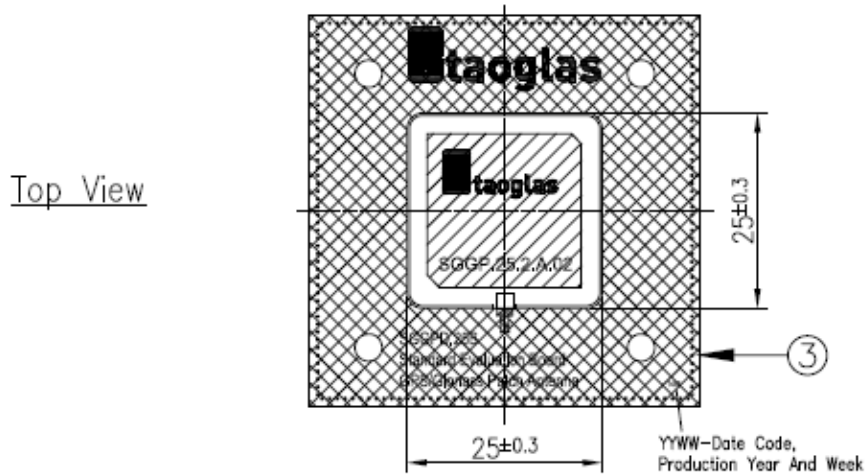

Unit:mm

Notes

1. Silver area
2. Solder mask
3. Solder Area

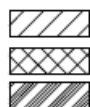

	Name	Material	Finish	QTY
1	PCB SMA(F) ST	Brass	Gold	1
2	SGGP.25.2.A.02 Antenna	Ceramic	Clear	1
3	PCB (50x50x1mm)	Composite	Black	1



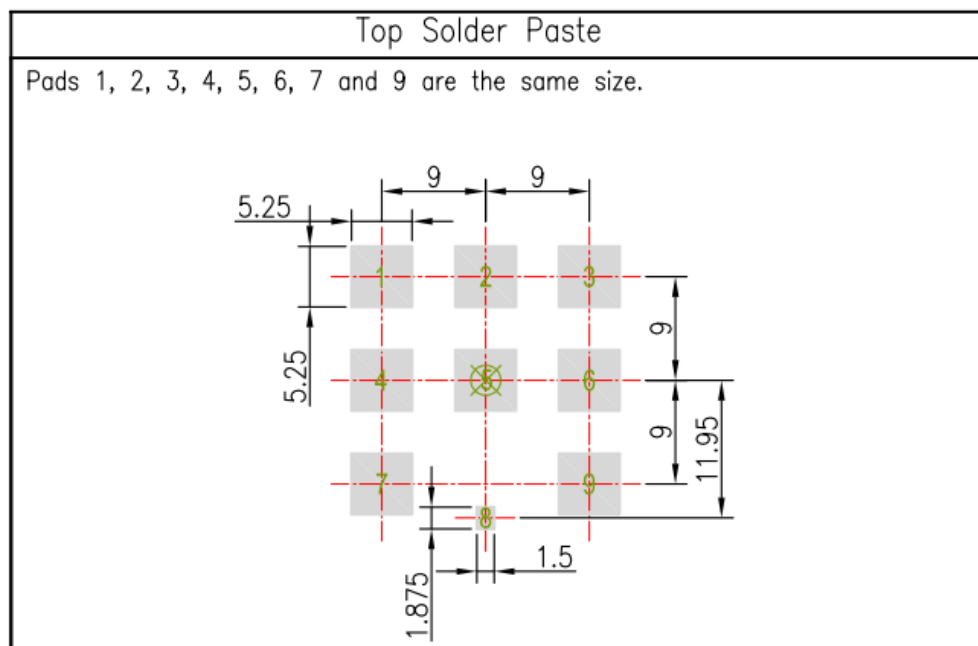
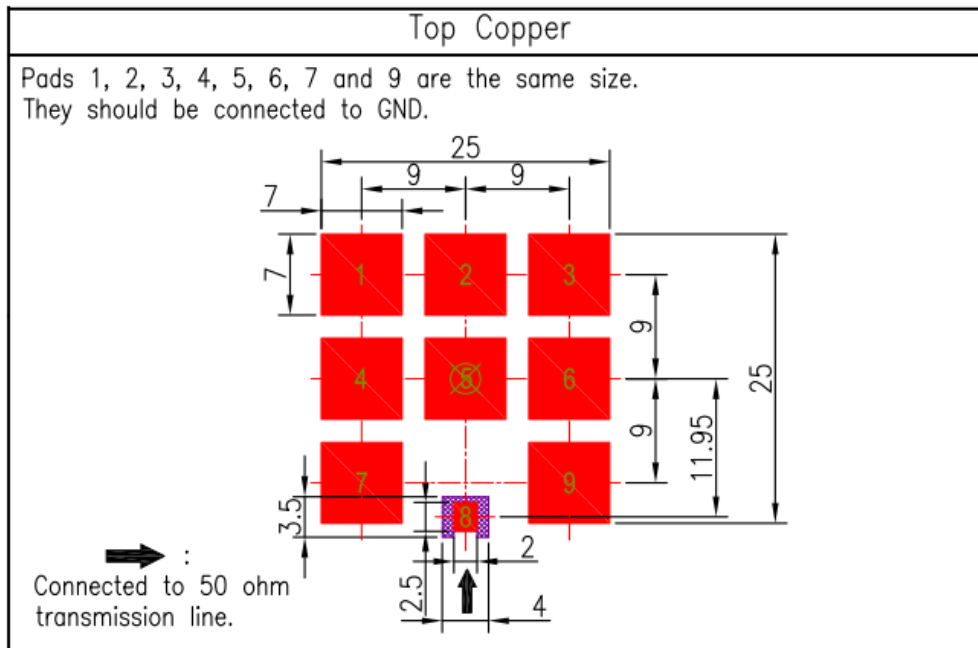

7. PCB Footprint Recommendation

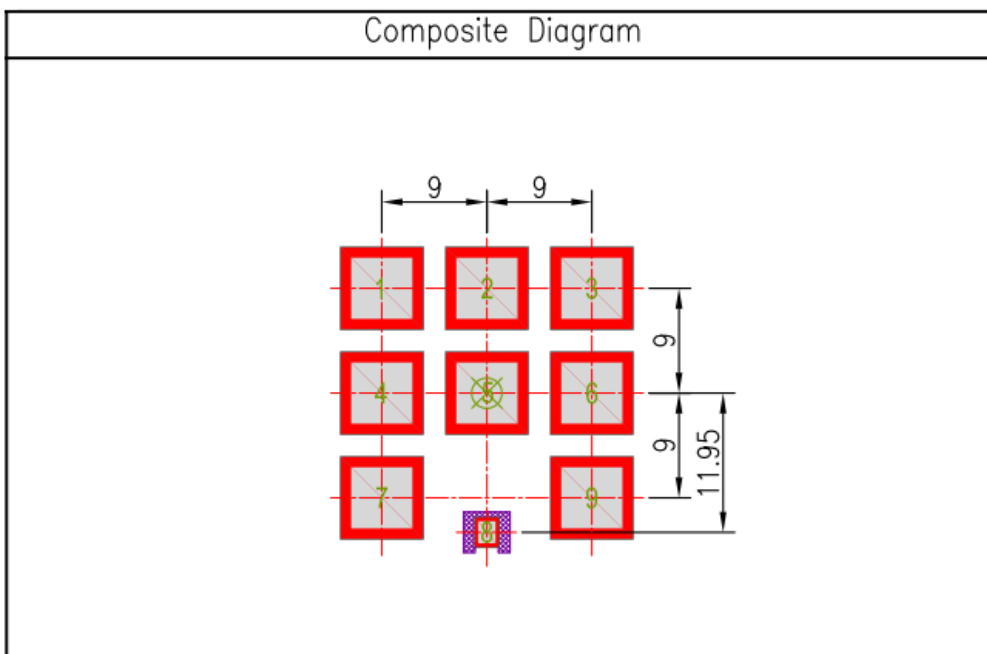
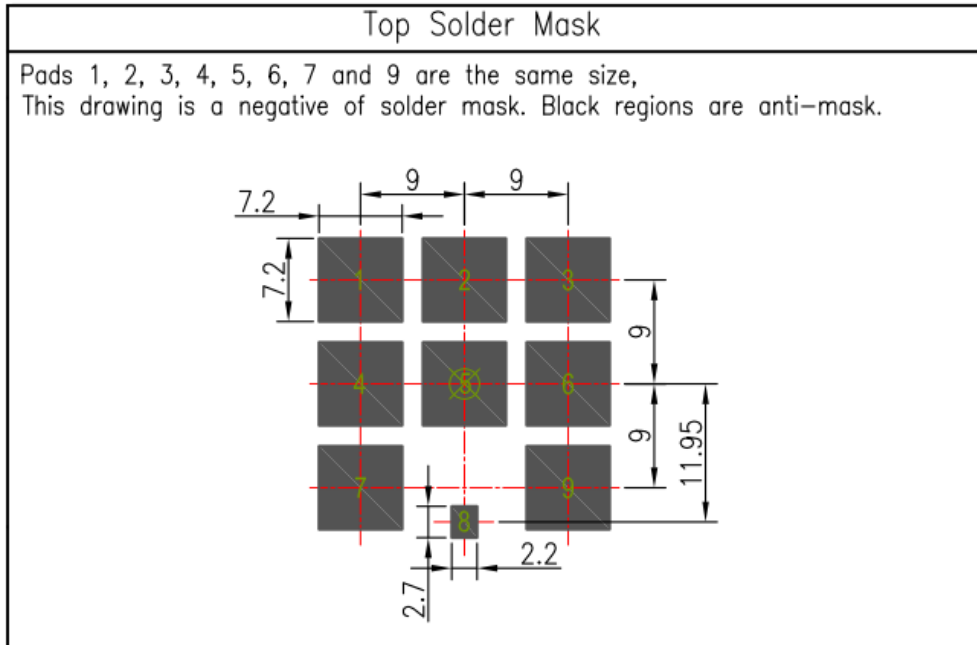

Unit:mm



Unit:mm

NOTE:			
1. Ag Plated area		6. Copper keepout should extend through all PCB layers.	
2. Solder Mask area		7. Any vias in pads should be either filled or tented to prevent solder from wicking away from the pad during reflow.	
3. Copper area			
4. Paste area			
5. Copper Keepout Area		8. The dimension tolerances should follow standard PCB manufacturing guidelines	

8. Recommended Reflow Soldering Profile

SGGP.12 can be assembled following Pb-free assembly. According to the Standard IPC/JEDEC J-STD-020C, the temperature profile suggested is as follows:

Phase	Profile Features	Pb-Free Assembly (SnAgCu)
PREHEAT	Temperature Min(T_{smin})	150°C
	Temperature Max(T_{smax})	200°C
	Time(t_s) from (T_{smin} to T_{smax})	60-120 seconds
RAMP-UP	Avg. Ramp-up Rate (T_{smax} to T_p)	3°C/second(max)
REFLOW	Temperature(T_L)	217°C
	Total Time above T_L (t_L)	30-100 seconds
PEAK	Temperature(T_p)	260°C
	Time(t_p)	2-5 seconds
RAMP-DOWN	Rate	3°C/second(max)
Time from 25°C to Peak Temperature		8 minutes max.
Composition of solder paste		96.5Sn/3Ag/0.5Cu
Solder Paste Model		SHENMAO PF606-P26

The graphic shows temperature profile for component assembly process in reflow ovens

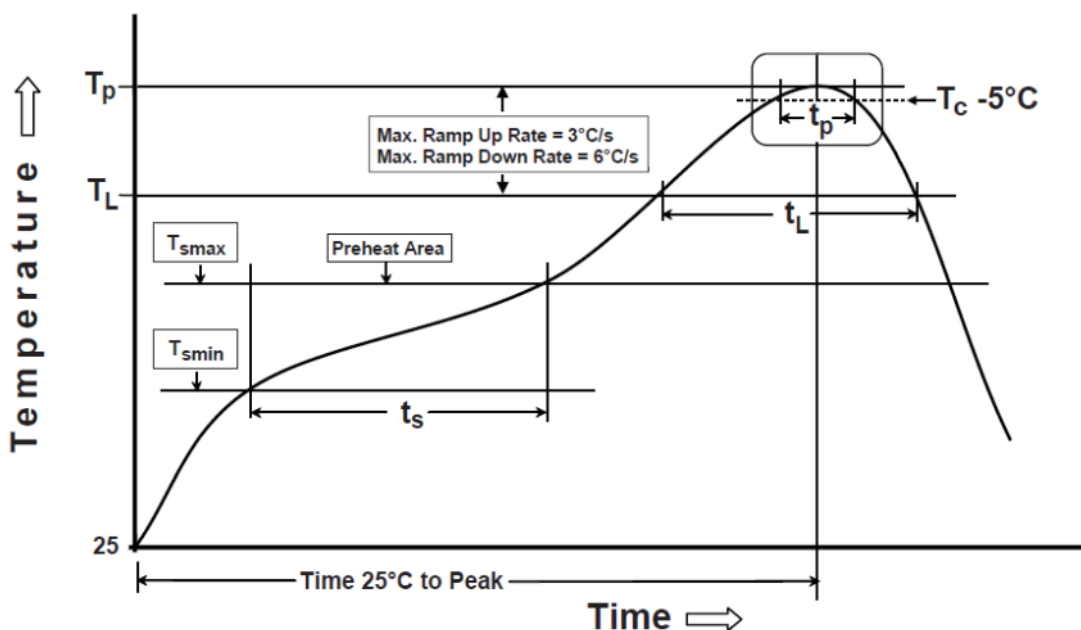

Soldering Iron condition: Soldering iron temperature $270^\circ\text{C} \pm 10^\circ\text{C}$.

Apply preheating at 120°C for 2-3 minutes. Finish soldering for each terminal within 3 seconds, if soldering iron temperature over $270^\circ\text{C} \pm 10^\circ\text{C}$ for 3 seconds, it may cause component surface peeling or damage.

9. Packaging

SGGP.25.2.A.02

Packaging Specifications (1/2)

200 pc SGGP.25.2.A.02 per reel
 Dimensions - Ø330*44mm
 Weight - 1.4Kg

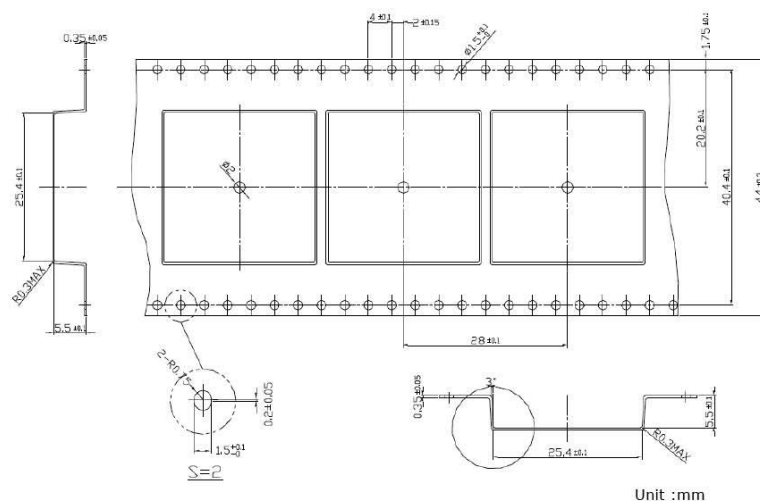
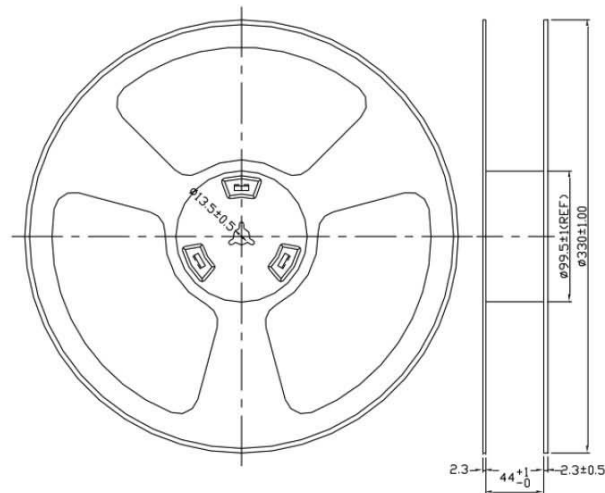

SGGP.25.2.A.02

Packaging Specifications (2/2)

1 pc reel in small inner box
 Dimensions - 350*340*70mm
 Weight - 1.8Kg

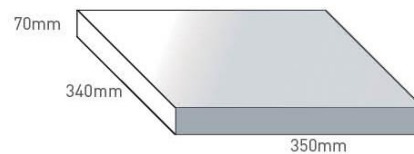

4 Reels / 800 pcs in one carton
 Carton Dimensions - 370*360*305mm
 Weight - 8Kg

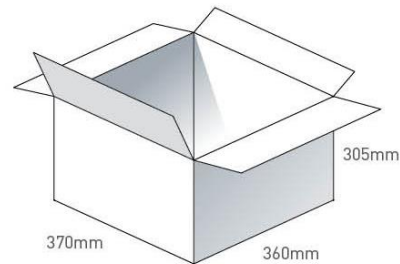

Pallet Dimensions 1100*1220*720mm
 24 Cartons per Pallet
 4 Cartons per layer
 6 Layers

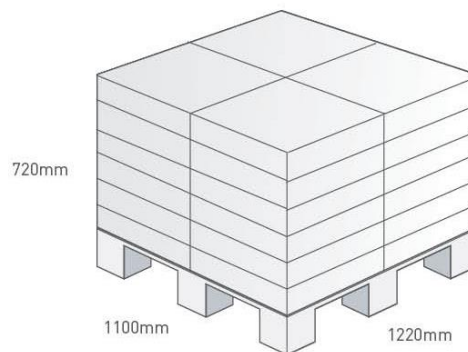

Taoglas makes no warranties based on the accuracy or completeness of the contents of this document and reserves the right to make changes to specifications and product descriptions at any time without notice. Taoglas reserves all rights to this document and the information contained herein.

Reproduction, use or disclosure to third parties without express permission is strictly prohibited.

Copyright © Taoglas Ltd.