

**1.6A Li-Ion Battery Charger in a 3x3 TDFN Package**

**General Description**

The AAT3696 BatteryManager™ is a single-cell lithium-ion (Li-Ion)/Li-Polymer battery charger IC designed to operate from USB ports or AC adapter up to an input voltage of 6.5V or 6.05V (depending on the option<sup>1</sup>). For increased safety, the AAT3696 also includes over-voltage input protection (OVP) up to 28V.

The AAT3696 precisely regulates battery voltage after it has reached 4.2V or 4.375V (depending on the option<sup>1</sup>) Li-Ion/Polymer battery cells through an extremely low  $R_{DS(ON)}$  switch. The charging current can be set by an external resistor up to 1.6A. In case an over-voltage condition occurs from the input, a series switch quickly opens and a fault flag is activated to prevent damage to the battery and charging circuitry.

Other fault conditions are monitored in real time. In case of an over-current, battery over-voltage, short circuit, or over-temperature failure, the device will automatically shut down, thus protecting the charging device, control system, and the battery under charge. A status monitoring output pin (STAT) is provided to indicate charging activity. This open-drain output pin can be used to drive an external LED as a charging indicator. The AAT3696 has two charge termination mode selections when the battery voltage has reached the constant voltage level  $V_{CO(REG)}$  and the charging current has decreased the termination current level.

The AAT3696 offers a 4.9V/30mA LDO linear regulator. This regulator is enabled all the time regardless of the status of the charger and protected by the OVP switch.

The AAT3696 is available in the Pb-free, thermally enhanced, space-saving 3x3mm TDFN33-12 package and is rated over the -40°C to +85°C temperature range.

**Features**

- USB or AC Adapter System Power Charger
- 3.0V ~ 6.5V or 6.05V Input Voltage Range
- 2.8V Typical Under-Voltage Lockout Threshold
- Fast Over-Voltage Protection Turn Off
- Two OVP Turn-On Delay Time Options:
  - 40µs
  - 80ms
- Two OVP Trip Point Options:
  - Protection Trip at 6.75V
  - Protection Trip at 6.25V
- High Level of Integration with Internal:
  - Power Device
  - Reverse Current Blocking
  - Current Sensing
- 4.9V/30mA LDO Output Through Over-Voltage Protection Device
- Programmable Current from 100mA to 1.6A Max
- Charge Status Indicator
- Automatic Recharge Sequencing
- Automatic Trickle Charge For Battery Pre-Conditioning
- Emergency Thermal Shutdown Protection
- Power on Reset and Soft Start
- Active Low Enable with Internal 200kΩ Pull-Down Resistor
- Two Charge Termination Control Selections:
  - Manual: Continuous Battery Charging Until Charge Termination by Enable Pin
  - Automatic: Battery Charging is Terminated with Transition to Sleep State
- 12-pin 3x3mm TDFN Package

**Applications**

- Bluetooth™ Headsets, Headphones, Accessories
- Digital Still Cameras
- Mobile Telephones
- MP3 Players
- Personal Data Assistants (PDAs)

1. Please refer to Table 9 on page 19 for complete list of options.

# AAT3696

## 1.6A Li-Ion Battery Charger in a 3x3 TDFN Package

### Typical Application

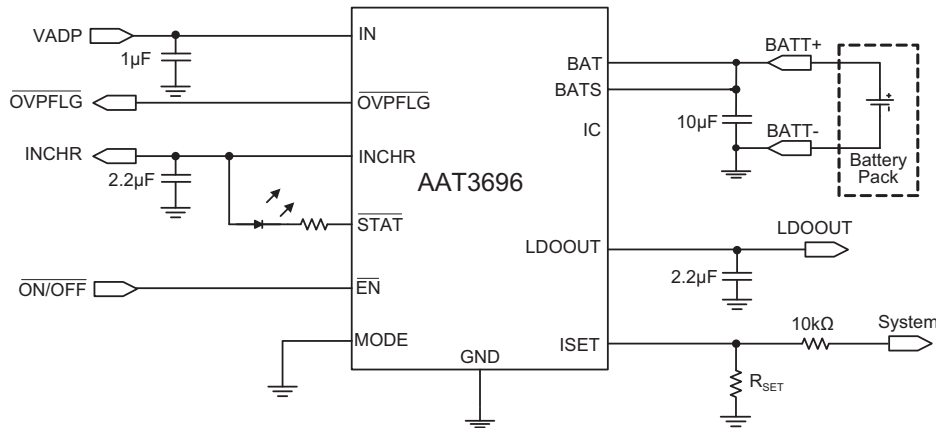

### Pin Descriptions

Pin #	Name	Type	Function
1	INCHR	I/O	Output of over-voltage protection (OVP) stage and input to battery charger. Decouple to GND with 2.2µF capacitor.
2	IN	I	Input from USB port or AC adapter.
3	LDOOUT	O	4.9V/30mA LDO output through OVP device. Bypass to GND with 2.2µF capacitor.
4	OVPFLG	O	Over-voltage fault flag, open drain, active low.
5	STAT	O	Charge status indicator pin, open drain, active low.
6	MODE	I	MODE selection pin (internal connect with a 200kΩ pull-up resistor to INCHR). Factory default at 10% termination current if MODE is open or connect to INCHR. Continues to charge if MODE is connect to GND.
7	GND	I/O	Power ground.
8	EN	I	Active low enable pin (internal connect with a 200kΩ pull-down resistor).
9	ISET	I	Connect R <sub>SET</sub> resistor here to set adaptor or USB charging current.
10	IC	I	Internally connected through 100kΩ resistor to GND. Leave this pin open.
11	BATS	I	Battery voltage remote sense input.
12	BAT	O	Connect to Li-Ion battery.
EP			Exposed paddle (bottom); The exposed thermal pad (EP) should be connected to board ground plane and pin 7. The ground plane should include a large exposed copper pad under the package for thermal dissipation (see package outline).

### Pin Configuration

#### TDFN33-12 (Top View)

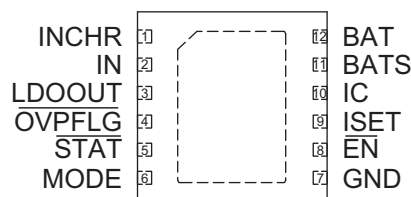

**1.6A Li-Ion Battery Charger in a 3x3 TDFN Package****Absolute Maximum Ratings<sup>1</sup>**

Symbol	Description	Value	Units
$V_{IN}$	IN continuous	-0.3 to 30	V
$V_P$	INCHR, $\overline{EN}$ , STAT, $\overline{OVPFLG}$ , MODE	-0.3 to 7.5	V
$V_N$	BAT, BATS, LDOOUT, ISET, IC	-0.3 to $V_P + 0.3$	V
$T_J$	Junction Temperature Range	-40 to 150	°C
$T_A$	Operating Temperature Range	-40 to 85	°C
$T_{LEAD}$	Maximum Soldering Temperature (at Leads)	300	°C

**Thermal Information<sup>2</sup>**

Symbol	Description	Value	Units
$\theta_{JA}$	Maximum Thermal Resistance (TDFN33-12)	50	°C/W
$P_D$	Maximum Power Dissipation	2	W

1. Stresses above those listed in Absolute Maximum Ratings may cause permanent damage to the device. Functional operation at conditions other than the operating conditions specified is not implied. Only one Absolute Maximum Rating should be applied at any one time.
2. Mounted on an FR4 board.

# DATA SHEET

# AAT3696

## 1.6A Li-Ion Battery Charger in a 3x3 TDFN Package

### Electrical Characteristics<sup>1</sup>

$V_{IN} = 5V$ ,  $T_A = -40$  to  $+85^\circ C$ ,  $R_{SET} = 3.16k\Omega$ ,  $V_{MODE} = 0V$ ,  $BAT = BATS$ , unless otherwise noted. Typical values are at  $T_A = 25^\circ C$

Symbol	Description	Conditions	Min	Typ	Max	Units
<b>Operation</b>						
$V_{IN\_MAX}$	Input Over-Voltage Protection Range				28	V
$V_{IN}$	Normal Operating Input Voltage Range <sup>2, 3</sup>	Refer to Table 4	3.0		6.5	V
		Refer to Table 4	3.0		6.05	
$I_{OP}$	Operating Current	$R_{SET} = 15.8 k\Omega$ , $V_{EN} = 0V$ , $V_{IN} = 5V$		0.5	0.6	mA
$I_{SD}$	Charge Function Shutdown Supply Current (OVP function still active)	$V_{IN} = V_{EN} = 5.5V$		160	220	$\mu A$
$I_{BAT}$	Leakage Current from BAT Pin	$V_{BAT} = 4V$ , IN Pin Open		0	1	$\mu A$
<b>Over-Voltage Protection</b>						
$V_{OVPT}$	Over-Voltage Protection Trip Point <sup>2, 3</sup>	$V_{IN}$ Rising Edge; Refer to Table 4	6.5	6.75	7.0	V
		$V_{IN}$ Rising Edge; Refer to Table 4	6.05	6.25	6.45	
	Hysteresis			100		mV
$V_{DO\_OVP}$	Dropout Voltage between IN and INCHR Pins	$V_{IN} = 5V$ , $I_{LOAD@BAT} = 1000mA$ , $R_{SET} = 1k\Omega$		200		mV
<b>Battery Charger</b>						
$V_{UVLO}$	Under-Voltage Lockout Threshold	$V_{IN}$ Rising edge	2.5	2.8	3.0	V
	UVLO Hysteresis			150		mV
$V_{DO\_CHARGE}$	Dropout Voltage between INCHR and BAT Pins	$V_{IN} = 4.2V$ , $I_{LOAD@BAT} = 1000mA$ , $R_{SET} = 1k\Omega$		200		mV
$V_{BOVP}$	Battery Over-Voltage Protection Threshold			4.4		V
<b>Voltage Regulation</b>						
$V_{CO(REG)}$	Constant Output Voltage <sup>2, 3</sup>	Refer to Table 4		4.20		V
		Refer to Table 4		4.375		
$\Delta V_{CO}/V_{CO}$	Constant Output Voltage Tolerance	$T_A = 25^\circ C$	-0.5		+0.5	%
		$T_A = -40^\circ C$ to $+85^\circ C$	-1		+1	%
$V_{RCH}$	Battery Recharge Voltage Threshold	MODE = High		$V_{CO(REG)} - 0.1$		V
$V_{MIN}$	Preconditioning Voltage Threshold <sup>2, 3</sup>	Refer to Table 4	2.4	2.6	2.8	V
		Refer to Table 4	2	2.2	2.4	
<b>Current Regulation</b>						
$I_{CC\_RANGE}$	Charge Current Programmable Range		100		1600	mA
$I_{CH\_CC}$	Constant-Current Mode Charge Current	$R_{SET} = 15.8k\Omega$ , $V_{BAT} = 3.6V$	-15%	110	+15%	mA
		$R_{SET} = 3.16k\Omega$ , $V_{BAT} = 3.6V$	-10%	500	+10%	mA
		$R_{SET} = 1.58k\Omega$ , $V_{BAT} = 3.6V$	-10%	1000	+10%	mA
		$R_{SET} = 1k\Omega$ , $V_{BAT} = 3.6V$	-15%	1500	+15%	mA
$V_{ISET}$	ISET Pin Voltage	$T_A = 25^\circ C$	1.98	2	2.02	V
		$T_A = -40^\circ C$ to $+85^\circ C$	1.9	2	2.1	
$KI_{ISET}$	Charge Current Set Factor: $I_{CH\_CC}/I_{ISET}$	$V_{BAT} = 3.6V$		790		
$I_{CH\_TRK}$	Trickle Charge Current	$V_{BAT} = 2.3V$		12		% $I_{CH\_CC}$
$I_{CH\_TERM}$	Charge Termination Threshold Current			10		% $I_{CH\_CC}$

1. The AAT3696 is guaranteed to meet performance specifications over the  $-40^\circ C$  to  $+85^\circ C$  operating temperature range and is assured by design, characterization and correlation with statistical process controls.

2. Only options -1, -2, -5, and -6 are available.

3. Please refer to Table 9 on page 19 for complete list of options.

## 1.6A Li-Ion Battery Charger in a 3x3 TDFN Package

### Electrical Characteristics<sup>1</sup>

$V_{IN} = 5V$ ,  $T_A = -40$  to  $+85^\circ C$ ,  $R_{ISET} = 3.16k\Omega$ ,  $V_{MODE} = 0V$ ,  $BAT = BATS$ , unless otherwise noted. Typical values are at  $T_A = 25^\circ C$

Symbol	Description	Conditions	Min	Typ	Max	Units	
<b>Logic Control / Battery Protection</b>							
$V_{EN(H)}, V_{MODE(H)}$	Input High Threshold	$V_{IN} = 5V$	1.2			V	
$V_{EN(L)}, V_{MODE(L)}$	Input Low Threshold				0.4	V	
$V_{STAT}$	Output Low Voltage	$\overline{STAT}$ pin sinks 4mA			0.4	V	
$I_{STAT}$	$\overline{STAT}$ Pin Current Sink Capability				8	mA	
$V_{OVPFLG}$	Output Low Voltage	$\overline{OVPFLG}$ pin sinks 4mA			0.4	V	
$I_{OVPFLG}$	$\overline{OVPFLG}$ Pin Current Sink Capability				8	mA	
$T_{DLY\_OVPFLG}$	$\overline{OVPFLG}$ Assertion Delay Time from Over-Voltage	From assertion of over-voltage condition (OV)		1		$\mu s$	
$T_{RESPOV}$	Over-Voltage Protection Response Time	$V_{IN}$ voltage step up from 6V to 8V, $R_{LOAD} = 100\Omega$ , $C_{INCHR} = 1\mu F$		0.5		$\mu s$	
$T_{OVPR}$	OVP Switch Turn-On Rise Time	$R_{LOAD} = 100\Omega$ , $C_{INCHR} = 1\mu F$		100		$\mu s$	
$T_{SHDN}$	Chip Thermal Shutdown Temperature	Threshold		140		$^\circ C$	
		Hysteresis		15			
<b>Options -1, -3, -5, -7, -9, -11, -13, -15</b>							
$T_{RELDLY\_OVPFLG\_40\mu s}$	$\overline{OVPFLG}$ Release Delay Time	From release of over-voltage condition (OV)		1.5		$\mu s$	
$T_{OVPO\_40\mu s}$	OVP Switch OVP Release Delay Time	$V_{IN}$ voltage step down from 8V to 6V, $R_{LOAD} = 100\Omega$ , $C_{INCHR} = 1\mu F$		40		$\mu s$	
$T_{OVPSTARTON\_40\mu s}$	OVP Switch Start Up Delay Time	$V_{IN}$ voltage step up from 0V to 5V, $R_{LOAD} = 100\Omega$ , $C_{INCHR} = 1\mu F$	150		250	$\mu s$	
<b>Options -2, -4, -6, -8, -10, -12, -14, -16</b>							
$T_{RELDLY\_OVPFLG\_80ms}$	$\overline{OVPFLG}$ Release Delay Time	From release of over-voltage condition (OV)		80		ms	
$T_{OVPO\_80ms}$	OVP Switch OVP Release Delay Time	$V_{IN}$ voltage step down from 8V to 6V, $R_{LOAD} = 100\Omega$ , $C_{INCHR} = 1\mu F$		80		ms	
$T_{OVPSTARTON\_80ms}$	OVP Switch Start Up Delay Time	$V_{IN}$ voltage step up from 0V to 5V, $R_{LOAD} = 100\Omega$ , $C_{INCHR} = 1\mu F$		80		ms	
<b>Low Dropout Regulator (LDO)</b>							
$V_{OUT}$	LDO Output Voltage Tolerance	$I_{LDOOUT} = 1mA$ to $30mA$ , $V_{IN} = 5.1V$	$T_A = 25^\circ C$	4.802	4.9	4.998	V
			$T_A = -40^\circ C$ to $85^\circ C$	4.729	4.9	5.071	
		$V_{IN} = 5V$ , $I_{LDOOUT} = 50mA$		4.4			
$V_{DO}$	LDO Dropout Voltage	$I_{LDOOUT} = 30mA$ , $V_{IN} = 4.9V$		200	300	mV	
$I_{LIM}$	LDO Current Limit	$V_{OUT} = 0V$		75		mA	
$\Delta V_{OUT}/V_{OUT} * \Delta V_{IN}$	LDO Line Regulation	$V_{IN} = 5V$ to $6V$ or $5.4V$ to $6.4V$ , $I_{LDOOUT} = 10mA$			0.09	%/V	
$\Delta V_{OUT(Line)}$	LDO Dynamic Line Regulation	$I_{LDOOUT} = 30mA$ , $V_{IN} = 5V$ to $6V$ or $5.4V$ to $6.4V$ , $T_R/T_F = 2\mu s$		25		mV	
$\Delta V_{OUT(Load)}$	LDO Dynamic Load Regulation	$I_{LDOOUT} = 1mA$ to $30mA$ , $T_R < 5\mu s$ ; $V_{IN} = V_{OUT(NOM)} + 1V$		60		mV	

1. The AAT3696 is guaranteed to meet performance specifications over the  $-40^\circ C$  to  $+85^\circ C$  operating temperature range and is assured by design, characterization and correlation with statistical process controls.

## Typical Characteristics – Battery Charger

Constant Charging Current vs. Set Resistor Values

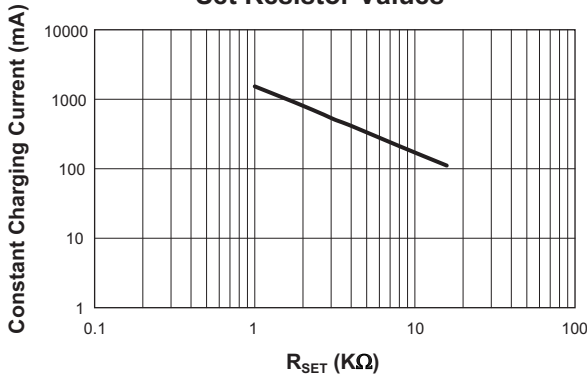

Operating Current vs. Set Resistor Values

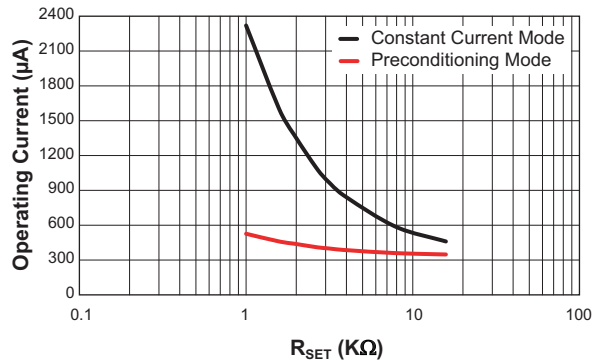

Constant Charging Current vs. Battery Voltage

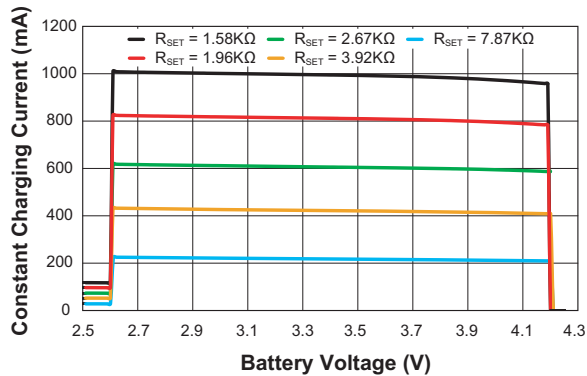

Constant Charging Current vs. Temperature ( $R_{SET} = 1.58K\Omega$ )

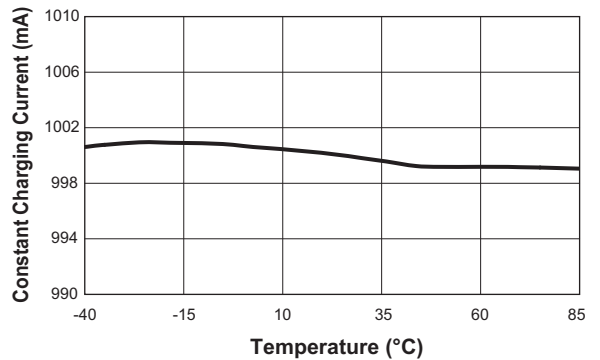

Constant Charging Current vs. Input Voltage ( $R_{SET} = 1.58K\Omega$ )

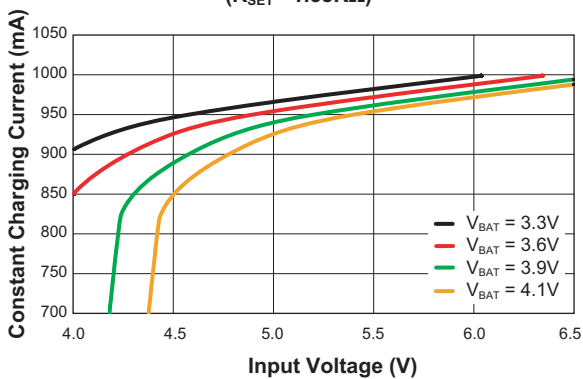

Constant Charging Current vs. Input Voltage ( $R_{SET} = 3.16K\Omega$ )

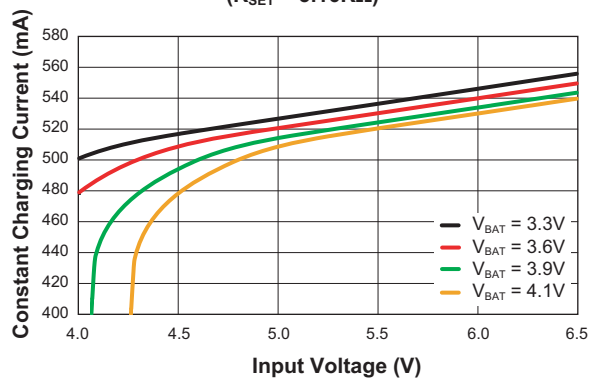

## 1.6A Li-Ion Battery Charger in a 3x3 TDFN Package

### Typical Characteristics–Battery Charger

**Preconditioning Voltage Threshold vs. Temperature**  
( $R_{SET} = 1.58K\Omega$ )

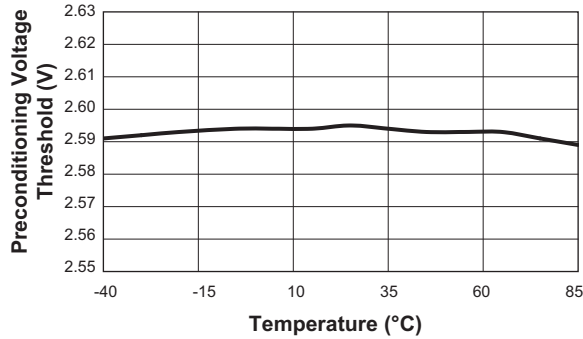

**Preconditioning Charge Current vs. Temperature**  
( $R_{SET} = 1.58K\Omega$ ;  $I_{CH\_CC} = 1000mA$ )

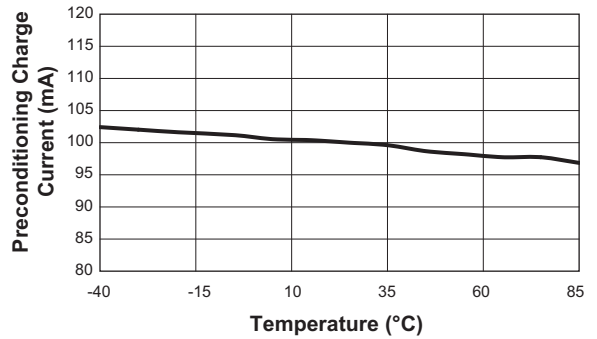

**Constant Output Voltage vs. Temperature**  
( $R_{SET} = 1.58K\Omega$ )

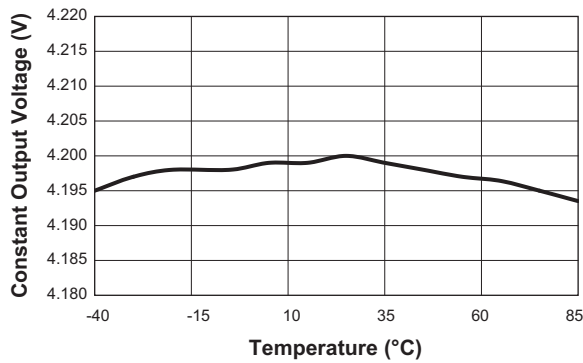

**Constant Output Voltage vs. Input Voltage**  
( $R_{SET} = 1.58K\Omega$ )

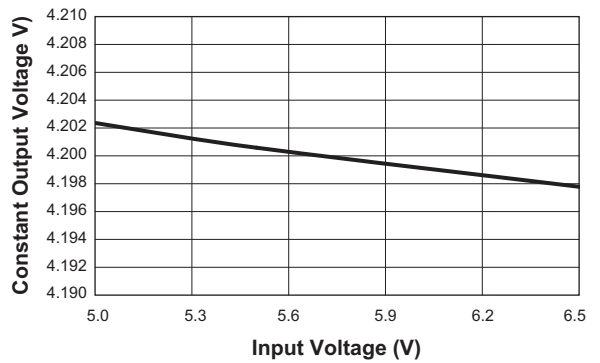

**Enable Input Low Voltage vs. Input Voltage**

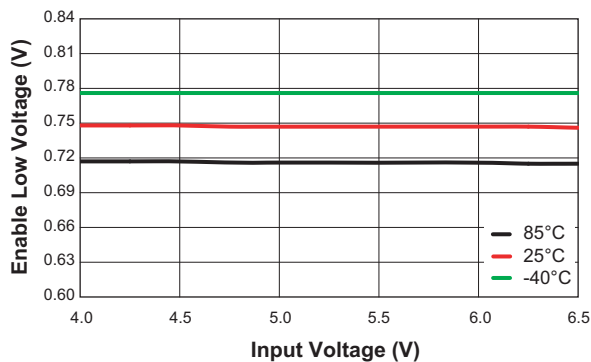

**Enable Input High Voltage vs. Input Voltage**

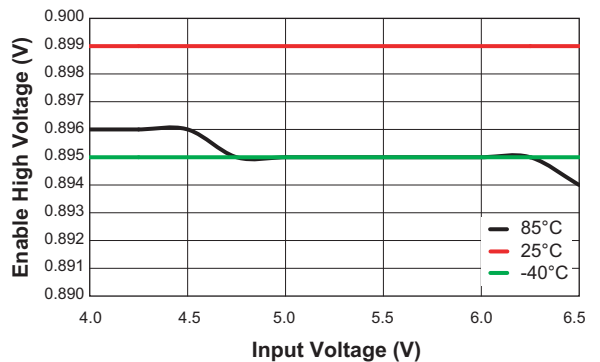

## 1.6A Li-Ion Battery Charger in a 3x3 TDFN Package

### Typical Characteristics—OVP

**OVPFLG Assertion Delay Time**  
( $R_{LOAD} = 100\Omega$ , OVP Trip Point 6.75V)

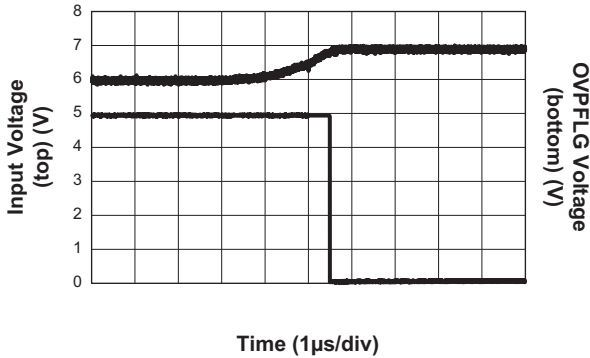

**OVPFLG Assertion Delay Time**  
( $R_{LOAD} = 100\Omega$ , OVP Trip Point 6.25V)

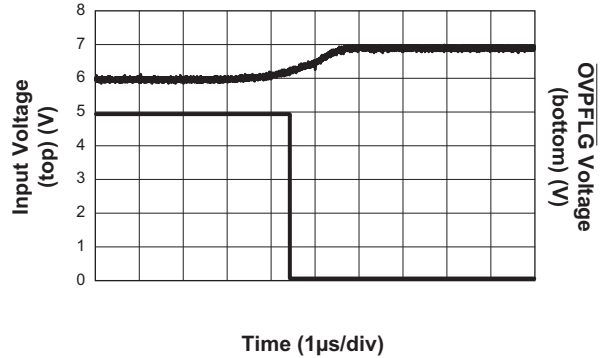

**OVPFLG Release Delay Time**  
( $R_{LOAD} = 100\Omega$ , OVP Trip Point 6.75V)

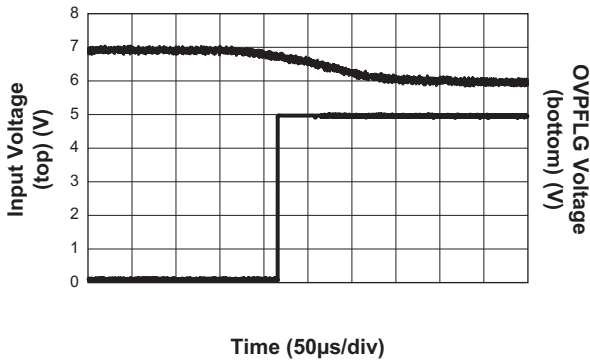

**OVPFLG Release Delay Time**  
( $R_{LOAD} = 100\Omega$ , OVP Trip Point 6.25V)

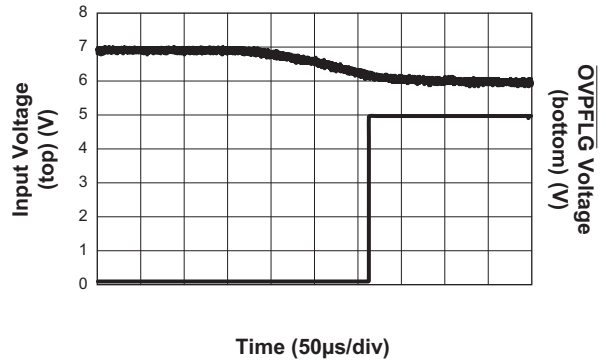

**OVP Switch Release Delay Time**  
( $R_{LOAD} = 100\Omega$ , All 40 $\mu$ s Delay Options)

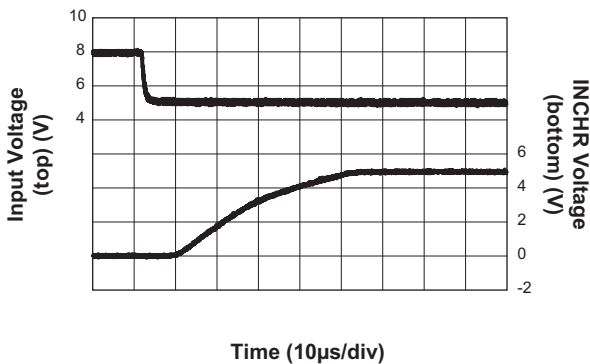

**OVP Switch Release Delay Time**  
( $R_{LOAD} = 100\Omega$ , All 80ms Delay Options)

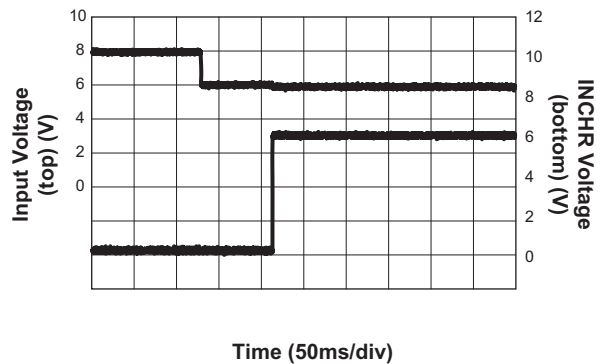



# AAT3696

## 1.6A Li-Ion Battery Charger in a 3x3 TDFN Package

### Typical Characteristics—OVP

**Over-Voltage Protection Response Time**  
( $R_{LOAD} = 100\Omega$ , All 80ms Delay Options)

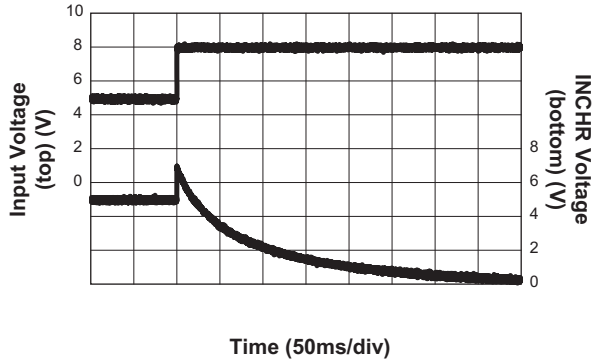

**Over-Voltage Protection Response Time**  
( $R_{LOAD} = 100\Omega$ , All 40μs Delay Options)

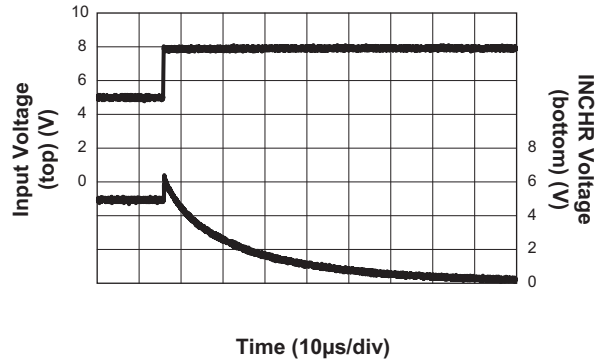

**OVP Trip Point vs. Temperature**

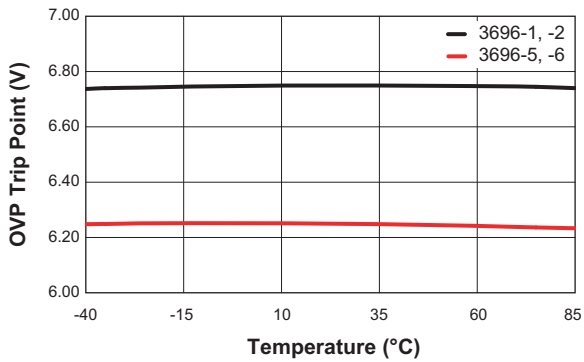

**Battery Recharge Voltage Threshold vs. Temperature**  
( $R_{SET} = 1.58K\Omega$ )

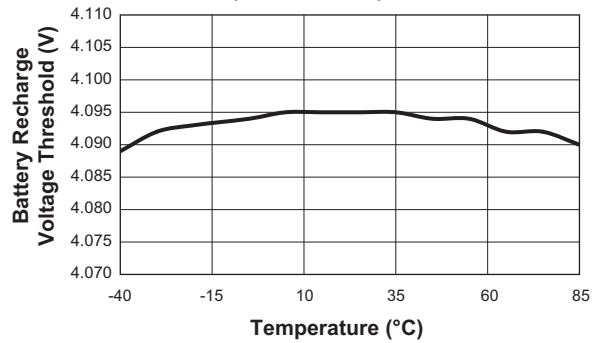

## Typical Characteristics–LDO

**LDO Output Voltage Accuracy vs. Input Voltage**  
( $I_{LDOOUT} = 10\text{mA}$ )

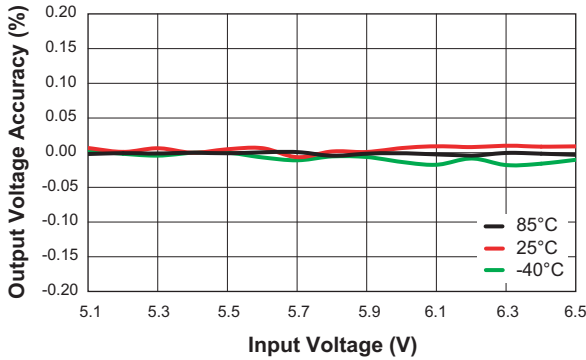

**LDO Output Voltage Accuracy vs. Input Voltage**  
( $I_{LDOOUT} = 30\text{mA}$ )

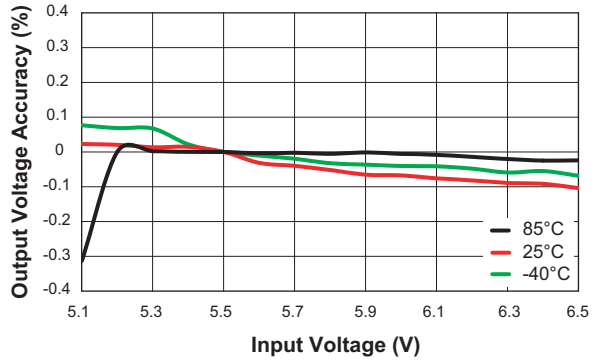

**LDO Output Voltage Accuracy vs. Temperature**  
( $I_{LDOOUT} = 10\text{mA}$ )

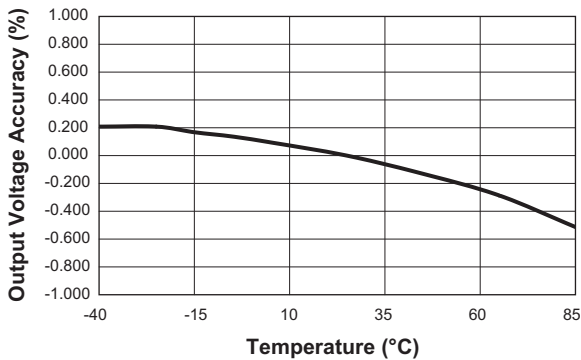

**LDO Output Voltage Accuracy vs. Temperature**  
( $I_{LDOOUT} = 30\text{mA}$ )

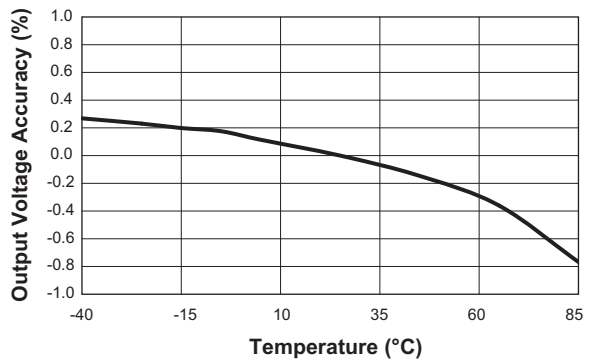

**LDO Output Voltage vs. Temperature**  
( $I_{LDOOUT} = 10\text{mA}$ )

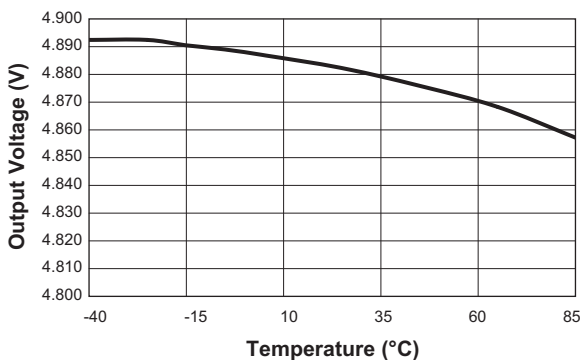

**LDO Output Voltage Accuracy vs. Output Current**  
( $V_{IN} = 5.1\text{V}$ ;  $V_{LDOOUT} = 4.9\text{V}$ )

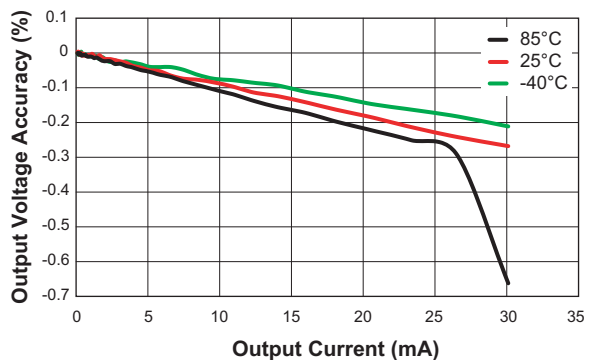

## Typical Characteristics–LDO

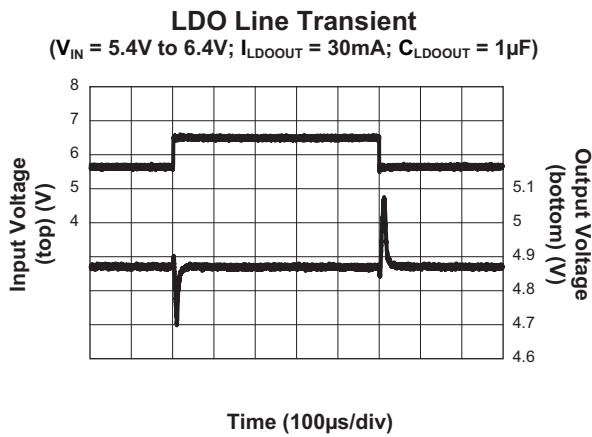
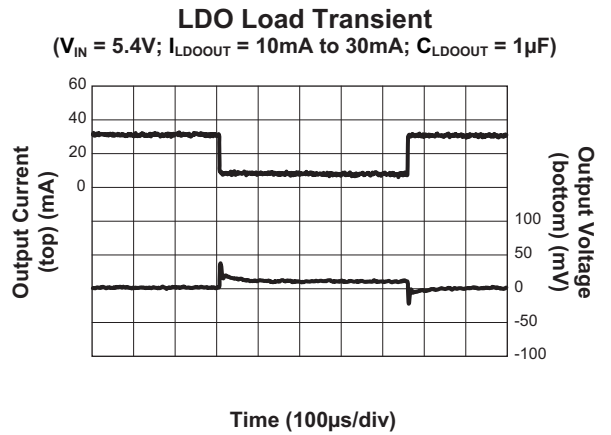
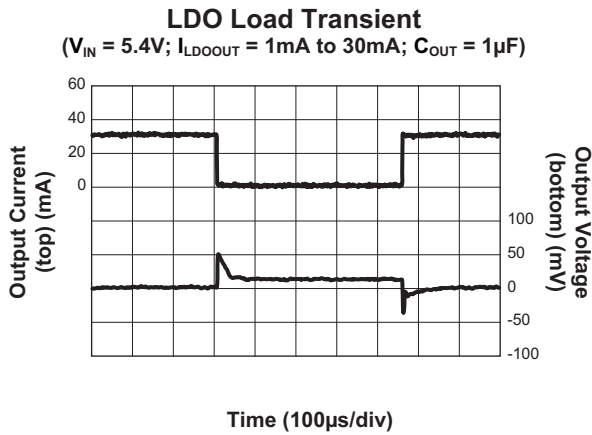

### LDO Dropout Voltage vs. Output Current

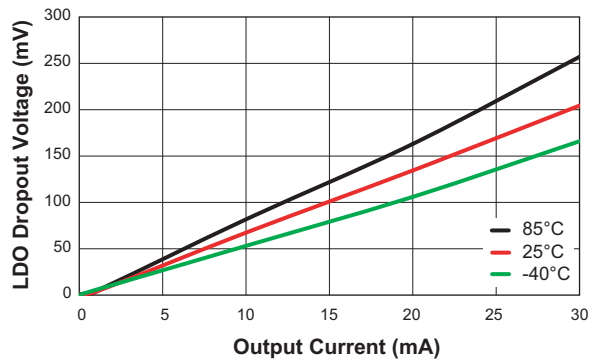

## Functional Block Diagram

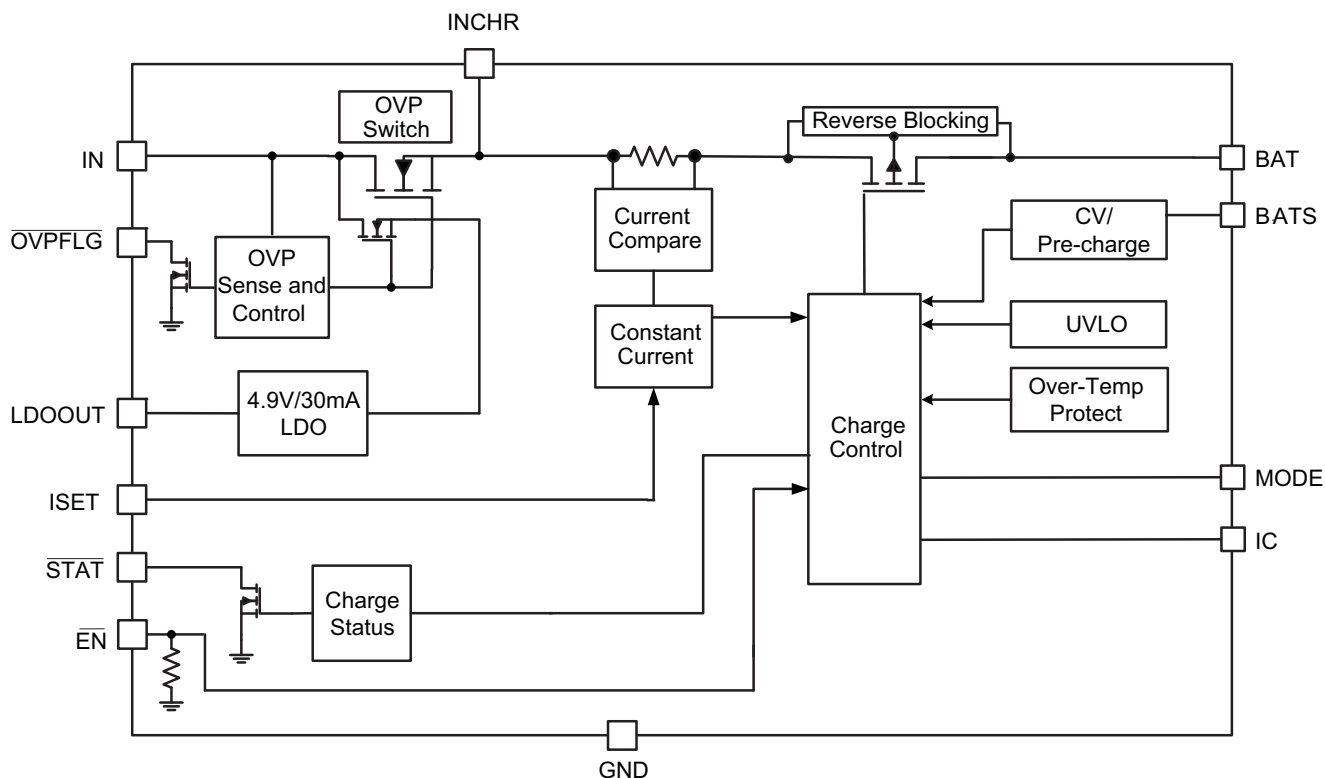

## Functional Description

The AAT3696 is a high performance battery charger IC designed to charge single-cell Lithium-Ion or Polymer batteries with up to 1.6A of current from external power source. It is a stand alone charging solution requiring minimum input components. Also included a fast turn-off over-voltage protection (OVP) circuits with +28V and this OVP consist of a low resistance P-channel MOSFET in series with the charge control MOSFET. The AAT3696 also designed with of under-voltage lockout protection, over-voltage monitor, fast shut-down circuitry with a fault output flag, and a 4.9V LDO with 30mA output through the OVP switch.

## Battery Charging Operation

Figure 1 illustrates the entire battery charging profile or operation, which consist of three phases:

1. Preconditioning (Trickle) Charge
2. Constant Current Charge
3. Constant Voltage Charge
4. Automatic Recharge when MODE = High

## Preconditioning Charge

Battery charging commences only after the AAT3696 checks several conditions in order to maintain a safe charging environment. The input supply must be above the minimum operating voltage, or under-voltage lock-out threshold ( $V_{UVLO}$ ) and the enable pin must be low for the charging sequence to begin. When these conditions have been met and a battery is connected to the BAT pin, the AAT3696 checks the state of the battery and determines which charging mode to apply. If the battery voltage is below the preconditioning voltage threshold ( $V_{MIN}$ ), then the AAT3696 begins preconditioning the cell (trickle charging) by charging at 10% of the programmed constant current. For example, if the programmed fast charge current is 1600mA, then the preconditioning (trickle charge) current is 160mA. Battery cell preconditioning is a safety precaution for deeply discharged cells and will also reduce the power dissipation in the internal series pass transistor when the voltage across the device is at greatest potential.

## 1.6A Li-Ion Battery Charger in a 3x3 TDFN Package

**Constant Current Charge**

Battery cell preconditioning charge continues until the battery voltage reaches the preconditioning voltage threshold ( $V_{MIN}$ ). At this point, the AAT3696 begins constant current charge. The current level for this mode is programmed using a single resistor from the ISET pin to ground. The programmed current can be set at a minimum 100mA up to a maximum of 1.6A.

**Constant Voltage Charge**

Constant current charge will continue until the battery voltage reaches the constant output voltage threshold,  $V_{CO(REG)}$ . The AAT3696 will then transition to constant voltage mode, where the charge IC regulates the battery voltage at constant output voltage (factory programmed to 4.2V or 4.375V). The charging current at this phase will decrease until the charge termination current or 10% of the programmed constant current is reached.

The AAT3696 has two charge termination control selections which can be set by the MODE pin.

**MODE = 0 (Ground or logic low)**

The charger regulates battery voltage at 4.2V or 4.375V optional voltage and continues to charge the battery with a current lower than the programmed charge termination current until the AAT3696 is disabled by applying logic high to the EN pin to stop charging.

**MODE = 1 (INCHR or logic high)**

The charger turns off the series pass device and automatically goes into a power-saving sleep state. During this time, a series pass device blocks the current in both directions, preventing the battery from discharging through the IC. The AAT3696 will remain in sleep mode until the battery voltage drops below the  $V_{RCH}$  threshold or the charger is enabled or input power is recycled. The AAT3696 will resume charging operation if no fault is detected.

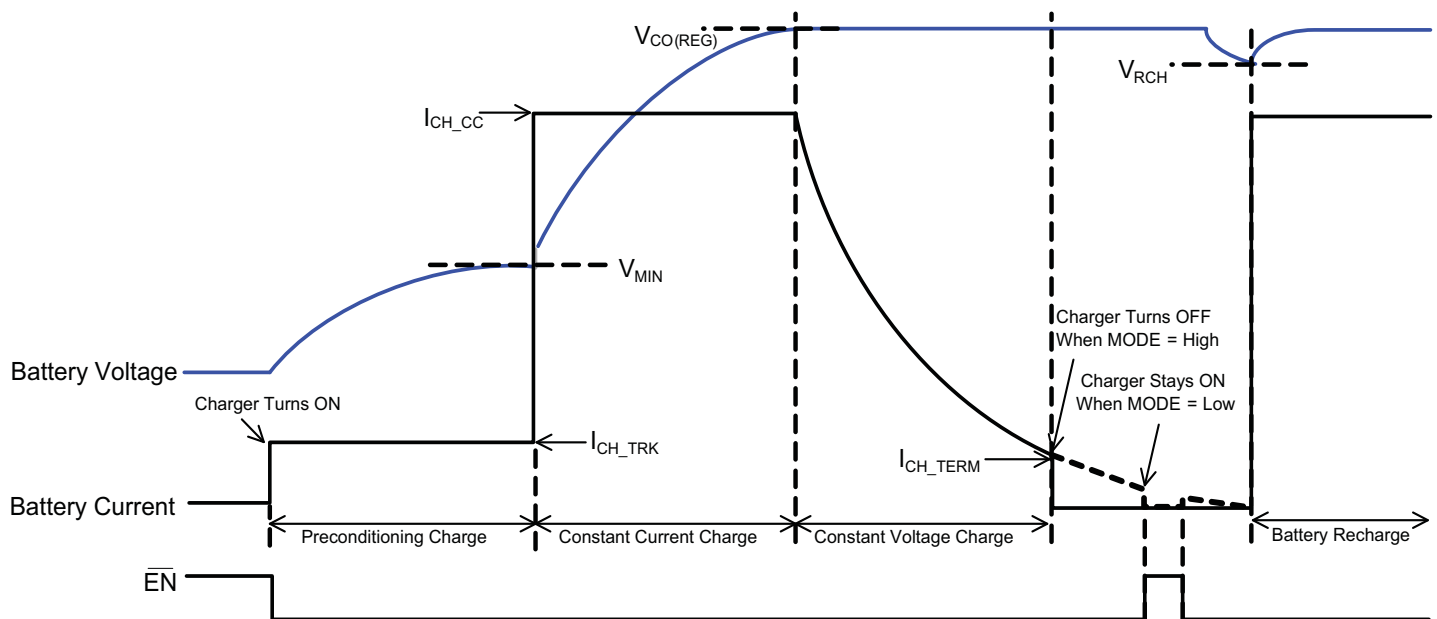

**Figure 1: Current vs. Voltage Profile during Charging Phases.**

**1.6A Li-Ion Battery Charger in a 3x3 TDFN Package**

**Charger Operational Flowchart**

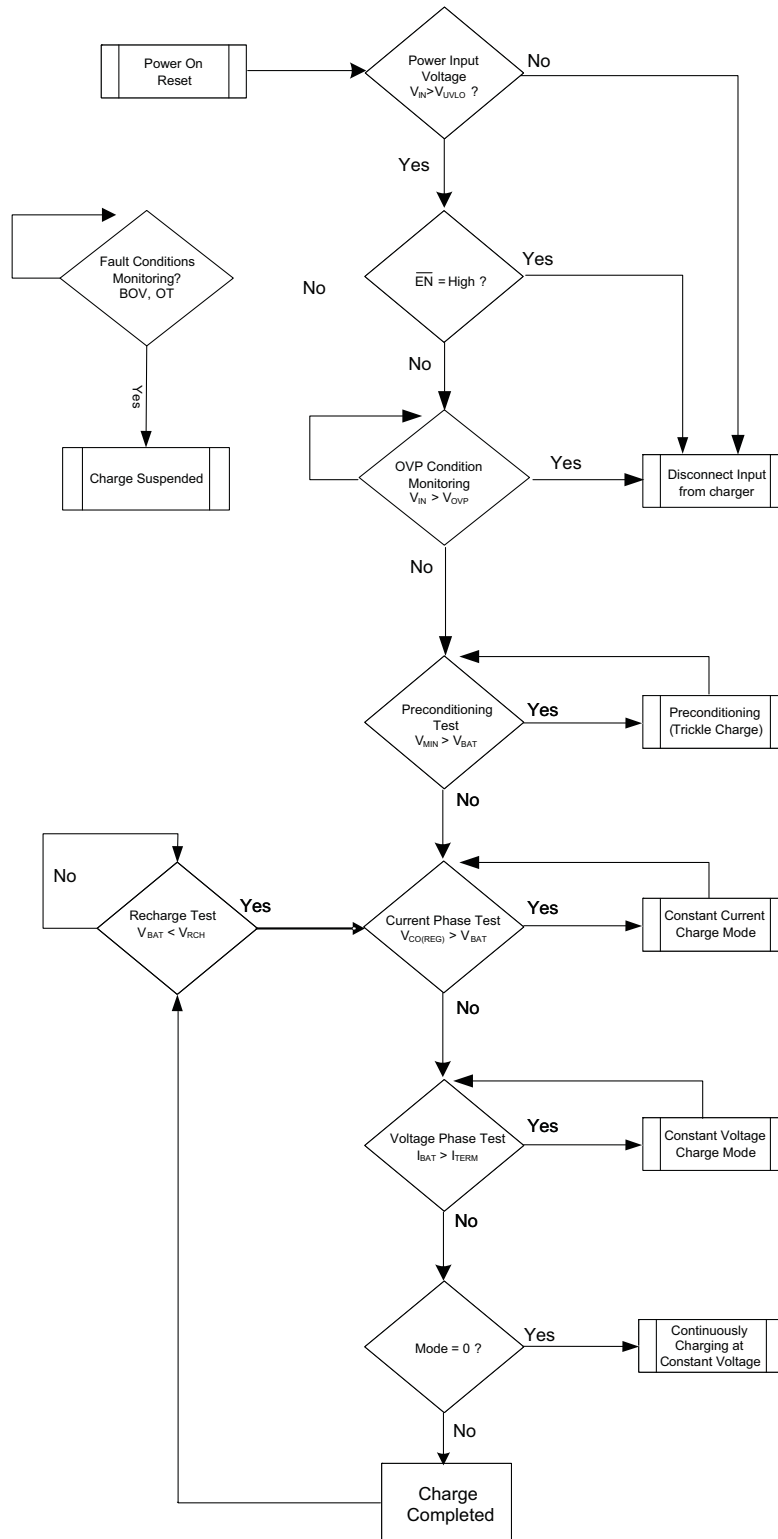

**1.6A Li-Ion Battery Charger in a 3x3 TDFN Package****Charge Status Output**

The AAT3696 provides battery charging status via a status pin,  $\overline{\text{STAT}}$ . This pin is internally connected to an N-channel open-drain MOSFET, which can be used as a logic signal, or drive an external LED. The charge status indication pin ( $\overline{\text{STAT}}$ ) pulls high indicating charge completion or charge termination, regardless of the selection of the charge termination mode, as long as the charge termination current is reached.

The status pin indicates the following conditions described in Table 1:

Charge Status	Status
Battery is charging	Low
Charging is completed	High
When $\overline{\text{EN}}$ is high	High

**Table 1: LED Status Indicator.**

**Enable/Disable**

The AAT3696 provides an enable function to control the charger IC on and off. The enable ( $\overline{\text{EN}}$ ) pin is internally pulled down with 200k $\Omega$ . When  $\overline{\text{EN}}$  is pulled down or left floating, normal device operation commences. When it is pulled to a logic high level, the AAT3696 charging circuit will be shut down and forced into sleep state but the over-voltage protection circuit remains in active state. Charging will be halted regardless of the battery voltage or charging state. When the device is re-enabled, the charge control circuit will automatically reset and resume charging functions with the appropriate charging mode based on the battery charge state and measured cell voltage at the BAT pin.

**Low Dropout Regulator**

The AAT3696 includes a low dropout regulator with input range from 5V to the OVP trip point which is 6.75V or 6.25V and is always enabled. The LDO output  $V_{\text{OUT}}$  is set to 4.9V and supplies a continuous current up to 30mA. The LDO output needs to be decoupled with 2.2 $\mu\text{F}$  to ground for stability reasons.

**Over-Voltage Protection**

In normal operation, an OVP switch acts as a load switch, connecting the power source from IN to INCHR. This switch is designed with very low resistance to minimize the voltage drop between the power source and

the charger and to reduce the power dissipation. When the voltage on the power source exceeds the OVP trip point, 6.75V or 6.25V respectively, the switch immediately becomes open (OFF) and disconnect the load and the charger from the power source therefore, preventing damage to any downstream components. Simultaneously, the fault flag is raised, alerting the system. If an over-voltage condition is applied at the time of the device enable, the switch remains open (OFF).

**Under-Voltage Lockout (UVLO)**

The AAT3696 has a 3V (maximum) under-voltage lockout level (UVLO). When the input voltage is less than the UVLO level, the OVP switch and the charger are turned off. It is designed with 150mV hysteresis to ensure circuit stability.

**Over-Voltage Fault Flag Output**

The over-voltage fault flag ( $\overline{\text{OVPFLG}}$ ) is an active-low open-drain fault reporting output. A pull-up resistor should be connected from to I/O voltage of the system. In the event of an over-voltage condition  $\overline{\text{OVPFLG}}$  will be asserted immediately with approximately 1 $\mu\text{s}$  inherited internal circuit delay. After the over-voltage fault is released,  $\overline{\text{OVPFLG}}$  will be de-asserted with 1.5 $\mu\text{s}$  delay (optional of 80ms delay).

**Battery Over-Voltage Protection**

An over-voltage event is defined as a condition where the voltage at the BAT pin exceeds the maximum battery charge voltage and is set by the battery over-voltage protection threshold ( $V_{\text{BOVP}}$ ). If an overvoltage condition occurs sensed by the BATS pin, the AAT3696 charge control will shut down the device until voltage at the BAT pin drops below  $V_{\text{BOVP}}$ . The AAT3696 will resume normal charging operation after the over-voltage condition is removed.

**Over-Temperature Shutdown**

The AAT3696 has a thermal protection control circuit which will shut down charging functions if the internal die temperature exceed the preset thermal limit threshold of 140°C. Once the internal die temperature falls below the thermal limit, normal operation will resume the previous charging state.

## 1.6A Li-Ion Battery Charger in a 3x3 TDFN Package

## Application Information

### Constant Charge Current

The constant current charge level is user programmed with a set resistor connected between the ISET pin and ground. The accuracy of the constant charge current, as well as the preconditioning trickle charge current, is dominated by the tolerance of the set resistor used. For this reason, a 1% tolerance metal film resistor is recommended for the set resistor function. The constant charge current levels from 100mA to 1.6A may be set by selecting the appropriate value from Table 2.

Charge current setting formula:

$$I_{CH\_CC} \text{ (typ)} = \frac{V_{ISET}}{R_{SET}} \cdot K_{ISET}$$

Constant Charge Current (mA)	Set Resistor Value (kΩ)
110	15.8
200	7.87
400	3.92
500	3.16
600	2.67
800	1.96
1000	1.58
1500	1.00

**Table 2: R<sub>SET</sub> Values.**

Figure 2 shows the relationship of constant charging current and set resistor values for the AAT3696.

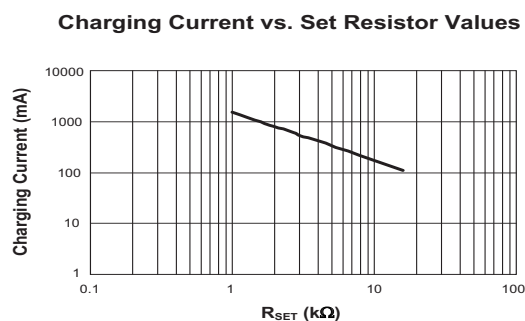

**Figure 2: Constant Charging Current vs. Set Resistor Values.**

Note: The ISET pin is very sensitive and if a total capacitive load of more than 20pF is connected, it may start oscillating.

### Battery Connection and Battery Voltage Sensing

#### Battery Connection (BAT)

A single cell Li-Ion/Polymer battery should be connected between BAT input and ground.

#### Battery Voltage Sensing (BATS)

The BATS pin is provided to employ an accurate voltage sensing capability to measure the positive terminal voltage at the battery cell being charged. This function reduces measured battery cell voltage error between the battery terminal and the charge control IC. The AAT3696 charge control circuit will base charging mode states upon the voltage sensed at the BATS pin. The BATS pin must be connected to the battery terminal for correct operation. If the battery voltage sense function is not needed, the BATS pin should be terminated directly to the BAT pin. If there is concern of the battery sense function inadvertently becoming an open circuit, the BATS pin may be terminated to the BAT pin using a 10kΩ resistor. Under normal operation, the connection to the battery terminal will be close to 0Ω; if the BATS connection becomes an open circuit, the 10kΩ resistor will provide feedback to the BATS pin from the BAT connection with a voltage sensing accuracy loss of 1mV or less.

#### Status Indicator Display

Simple system charging status states can be displayed using one LED in conjunction with the STAT pin on the AAT3696. This pin has a simple switch connecting the LED's cathode to ground. Refer to Table 1 for LED display definitions. The LED anodes should be connected to V<sub>IN</sub>, depending upon system design requirements. The LED should be biased with as little current as necessary to create reasonable illumination; therefore, a ballast resistor should be placed between the LED cathode and the STAT pin. LED current consumption will add to the overall thermal power budget for the device package, so it is wise to keep the LED drive current to a minimum. 2mA should be sufficient to drive most low cost green or red LED. It is not recommended to exceed 8mA when driving an individual status LED.

The required ballast resistor value can be estimated using the following formulas:

When connecting to the adapter supply with a red LED:

$$R_{B(STAT)} = \frac{V_{ADP} - V_{FLED}}{I_{LED(STAT)}}$$



**1.6A Li-Ion Battery Charger in a 3x3 TDFN Package**

Example:

$$R_{B(\overline{STAT})} = \frac{5.5V - 2.0V}{2mA} = 1.75k\Omega$$

Red LED forward voltage ( $V_F$ ) is typically 2.0V @ 2mA.

When connecting to the USB supply with a green LED:

$$R_{B(\overline{STAT})} = \frac{V_{USB} - V_{FLED}}{I_{LED(\overline{STAT})}}$$

Example:

$$R_{B(\overline{STAT})} = \frac{5.0V - 3.2V}{2mA} = 900\Omega$$

Green LED forward voltage ( $V_F$ ) is typically 3.2V @ 2mA.

**IC Input**

The AAT3696 has an IC input pin which is internally connected to ground through a 100k $\Omega$  resistor.

**Capacitor Selection****Input Capacitor**

A 1 $\mu$ F or larger capacitor is typically recommended for  $C_{IN}$ .  $C_{IN}$  should be located as close to the device IN pin as practically possible. Ceramic, tantalum, or aluminum electrolytic capacitors may be selected for  $C_{IN}$ . There is no specific capacitor equivalent series resistance (ESR) requirement for  $C_{IN}$ . However, for higher current operation, ceramic capacitors are recommended for  $C_{IN}$  due to their inherent capability over tantalum capacitors to withstand input current surges from low impedance sources such as batteries in portable devices.

Typically, 50V rated capacitors are required for most of the application to prevent any surge voltage. Ceramic capacitors selected as small as 1206 are available which can meet these requirements. Other voltage rating capacitor can also be used for the known input voltage application.

**Charger Input Capacitor**

A 2.2 $\mu$ F decoupling capacitor is recommended to be placed between INCHR and GND.

**Charger Output Capacitor**

The AAT3696 only requires a 1 $\mu$ F ceramic capacitor on the BAT pin to maintain circuit stability. This value should be increased to 10 $\mu$ F or more if the battery connection is made any distance from the charger output. If the AAT3696 is used in applications where the battery can be removed from the charger, such as desktop charging cradles, an output capacitor greater than 10 $\mu$ F may be required to prevent the device from cycling on and off when no battery is present.

**Linear Regulator Output Capacitor**

For proper load voltage regulation and operational stability, a capacitor is required between LDOOUT and GND. The output capacitor connection to the LDO regulator ground pin should be made as directly as practically possible for maximum device performance. Since the regulator has been designed to function with very low ESR capacitors, ceramic capacitors in the 1.0 $\mu$ F to 10 $\mu$ F range are recommended or best performance. Applications utilizing the exceptionally low output noise and optimum power supply ripple rejection of the AAT3696 should use 2.2 $\mu$ F or greater values for the LDO's output capacitor.

**Printed Circuit Board  
Layout Recommendations**

For proper thermal management and to take advantage of the low  $R_{DS(ON)}$  of the AAT3696, a few circuit board layout rules should be followed: IN and BAT should be routed using wider than normal traces, and GND should be connected to a ground plane. To maximize package thermal dissipation and power handling capacity of the AAT3696 TDFN3x3 package, solder the exposed paddle of the IC onto the thermal landing of the PCB, where the thermal landing is connected to the ground plane. If heat is still an issue, multi-layer boards with dedicated ground planes are recommended. Also, adding more thermal vias on the thermal landing would help the heat being transferred to the PCB effectively.

# AAT3696

## 1.6A Li-Ion Battery Charger in a 3x3 TDFN Package

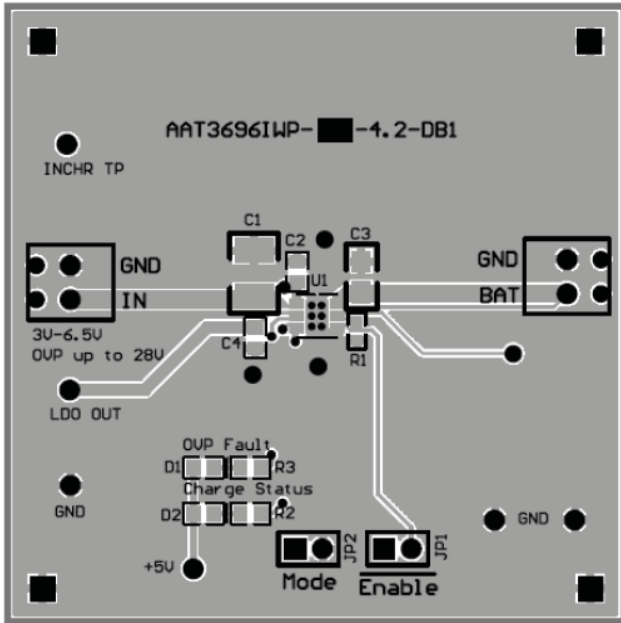

Figure 3: AAT3696 Evaluation Board Top Layer.

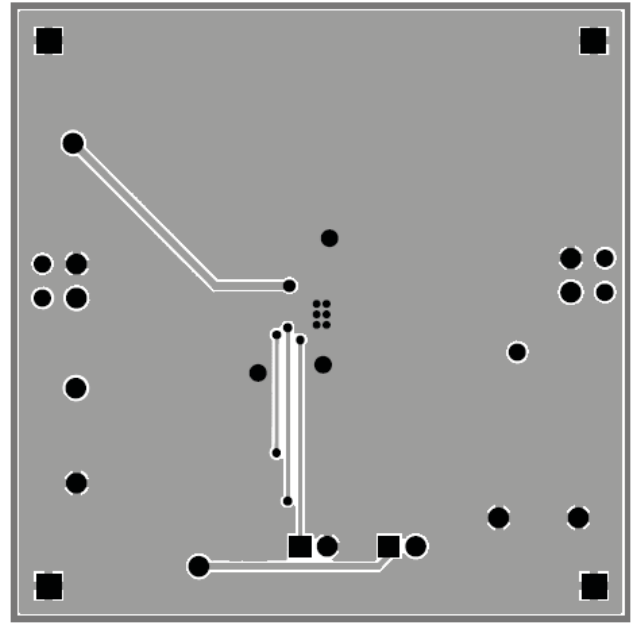

Figure 4: AAT3696 Evaluation Board Bottom Layer.

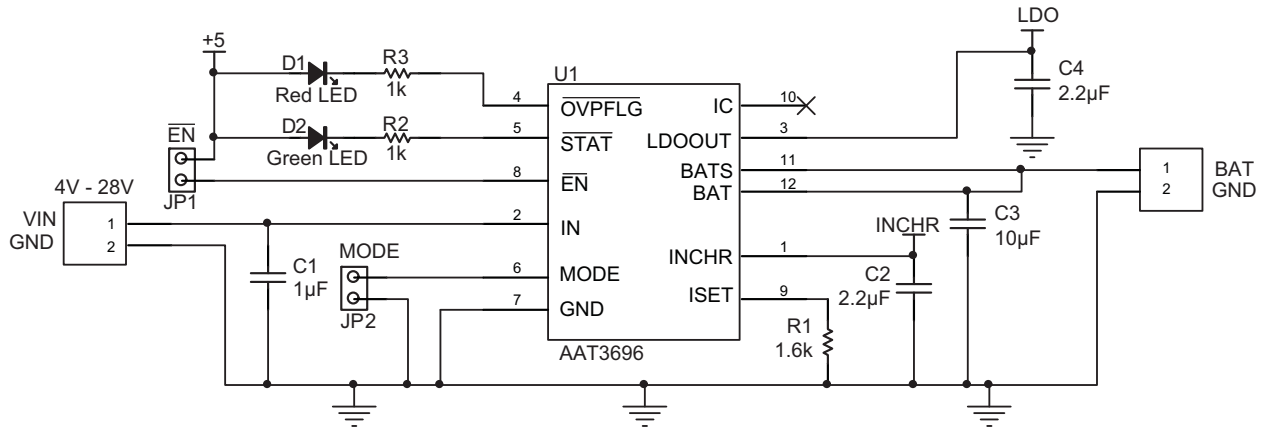

Figure 5: AAT3696 Evaluation Board Schematic.

**AAT3696****1.6A Li-Ion Battery Charger in a 3x3 TDFN Package**

Component	Part Number	Description	Manufacturer
U1	AAT3696IWP	1.6A Linear Li-Ion/Polymer Battery Charger in TDFN33-12 Package	Skyworks
R1	Chip Resistor	1.6k $\Omega$ , 1%, 1/4W; 0603	Vishay
R2, R3	Chip Resistor	1k $\Omega$ , 5%, 1/4W; 0603	Vishay
C1	GRM31MR71H105KA88	Ceramic 1 $\mu$ F 50V 10% X7R 1206	Murata
C2, C4	GRM188R61A225KE34	Ceramic 2.2 $\mu$ F 10V 10% X5R 0603	Murata
C3	GRM21BR71A106KE51L	Ceramic 10 $\mu$ F 10V 10% X7R 0805	Murata
JP1, JP2	PRPN401PAEN	Conn. Header, 2mm zip	Sullins Electronics
D1	LTST-C190CKT	Red LED; 0603	Lite-On Inc.
D2	LTST-C190GKT	Green LED; 0603	Lite-On Inc.

**Table 3: AAT3696 Evaluation Board Bill of Materials (BOM).****AAT3696 Feature Options**

Product	Constant Voltage Regulation (V)	OVP Trip Point (V)	OVP Turn On Delay Time ( $\mu$ s)	Preconditioning Voltage Threshold (V)
AAT3696-1	4.2	6.75	40	2.6
AAT3696-2	4.2	6.75	80,000	2.6
AAT3696-3	4.375	6.75	40	2.6
AAT3696-4	4.375	6.75	80,000	2.6
AAT3696-5	4.2	6.25	40	2.6
AAT3696-6	4.2	6.25	80,000	2.6
AAT3696-7	4.375	6.25	40	2.6
AAT3696-8	4.375	6.25	80,000	2.6
AAT3696-9	4.2	6.75	40	2.2
AAT3696-10	4.2	6.75	80,000	2.2
AAT3696-11	4.375	6.75	40	2.2
AAT3696-12	4.375	6.75	80,000	2.2
AAT3696-13	4.2	6.25	40	2.2
AAT3696-14	4.2	6.25	80,000	2.2
AAT3696-15	4.375	6.25	40	2.2
AAT3696-16	4.375	6.25	80,000	2.2

**Table 4: AAT3696 Options.**

**1.6A Li-Ion Battery Charger in a 3x3 TDFN Package****Ordering Information**

Package	Marking <sup>1</sup>	Part Number (Tape and Reel) <sup>2, 3</sup>
<b>TDFN33-12</b>	<b>6EXYY</b>	<b>AAT3696IWP-1-T1</b>
<b>TDFN33-12</b>	<b>6FXYY</b>	<b>AAT3696IWP-2-T1</b>
TDFN33-12		AAT3696IWP-3-T1
TDFN33-12		AAT3696IWP-4-T1
<b>TDFN33-12</b>	<b>6GXYY</b>	<b>AAT3696IWP-5-T1</b>
<b>TDFN33-12</b>	<b>6HXY</b>	<b>AAT3696IWP-6-T1</b>
TDFN33-12		AAT3696IWP-7-T1
TDFN33-12		AAT3696IWP-8-T1
TDFN33-12		AAT3696IWP-9-T1
TDFN33-12		AAT3696IWP-10-T1
TDFN33-12		AAT3696IWP-11-T1
TDFN33-12		AAT3696IWP-12-T1
TDFN33-12		AAT3696IWP-13-T1
TDFN33-12		AAT3696IWP-14-T1
TDFN33-12		AAT3696IWP-15-T1
TDFN33-12		AAT3696IWP-16-T1



Skyworks Green™ products are compliant with all applicable legislation and are halogen-free.

For additional information, refer to *Skyworks*

*Definition of Green™*, document number

SQ04-0074.

1. XYY = assembly and date code.

2. Sample stock is generally held on part numbers listed in **BOLD**.

3. For detailed description of all options, refer to Table 4 on page 19.

**1.6A Li-Ion Battery Charger in a 3x3 TDFN Package**

**Package Information**

**TDFN33-12<sup>1</sup>**

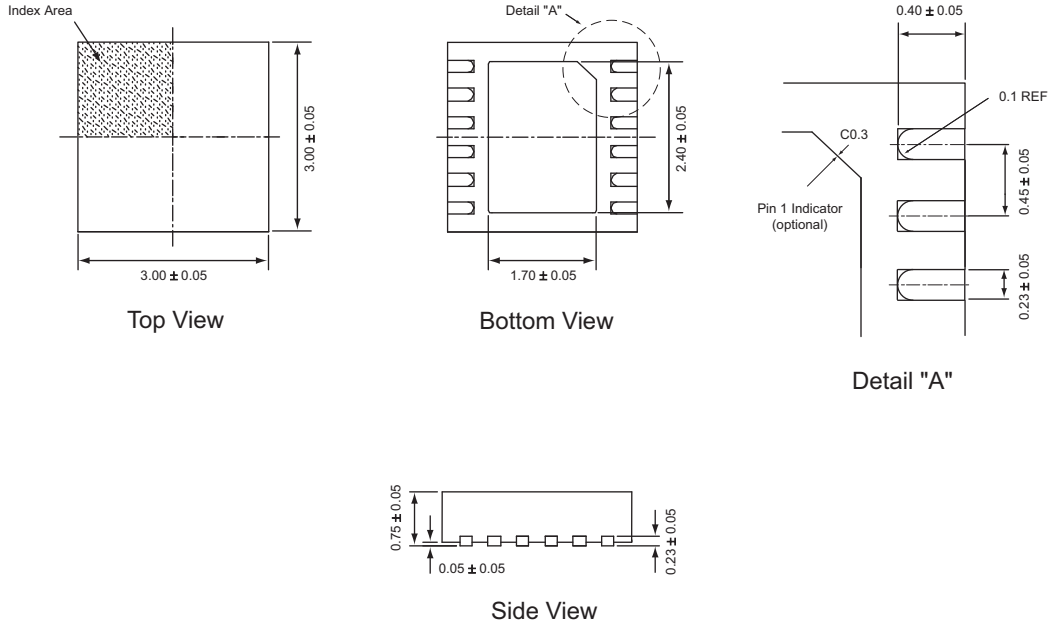

All dimensions in millimeters.

1. The leadless package family, which includes QFN, TQFN, DFN, TDFN and STDN, has exposed copper (unplated) at the end of the lead terminals due to the manufacturing process. A solder fillet at the exposed copper edge cannot be guaranteed and is not required to ensure a proper bottom solder connection.

Copyright © 2012 Skyworks Solutions, Inc. All Rights Reserved.

Information in this document is provided in connection with Skyworks Solutions, Inc. ("Skyworks") products or services. These materials, including the information contained herein, are provided by Skyworks as a service to its customers and may be used for informational purposes only by the customer. Skyworks assumes no responsibility for errors or omissions in these materials or the information contained herein. Skyworks may change its documentation, products, services, specifications or product descriptions at any time, without notice. Skyworks makes no commitment to update the materials or information and shall have no responsibility whatsoever for conflicts, incompatibilities, or other difficulties arising from any future changes.

No license, whether express, implied, by estoppel or otherwise, is granted to any intellectual property rights by this document. Skyworks assumes no liability for any materials, products or information provided hereunder, including the sale, distribution, reproduction or use of Skyworks products, information or materials, except as may be provided in Skyworks Terms and Conditions of Sale.

THE MATERIALS, PRODUCTS AND INFORMATION ARE PROVIDED "AS IS" WITHOUT WARRANTY OF ANY KIND, WHETHER EXPRESS, IMPLIED, STATUTORY, OR OTHERWISE, INCLUDING FITNESS FOR A PARTICULAR PURPOSE OR USE, MERCHANTABILITY, PERFORMANCE, QUALITY OR NON-INFRINGEMENT OF ANY INTELLECTUAL PROPERTY RIGHT; ALL SUCH WARRANTIES ARE HEREBY EXPRESSLY DISCLAIMED. SKYWORKS DOES NOT WARRANT THE ACCURACY OR COMPLETENESS OF THE INFORMATION, TEXT, GRAPHICS OR OTHER ITEMS CONTAINED WITHIN THESE MATERIALS. SKYWORKS SHALL NOT BE LIABLE FOR ANY DAMAGES, INCLUDING BUT NOT LIMITED TO ANY SPECIAL, INDIRECT, INCIDENTAL, STATUTORY, OR CONSEQUENTIAL DAMAGES, INCLUDING WITHOUT LIMITATION, LOST REVENUES OR LOST PROFITS THAT MAY RESULT FROM THE USE OF THE MATERIALS OR INFORMATION, WHETHER OR NOT THE RECIPIENT OF MATERIALS HAS BEEN ADVISED OF THE POSSIBILITY OF SUCH DAMAGE.

Skyworks products are not intended for use in medical, lifesaving or life-sustaining applications, or other equipment in which the failure of the Skyworks products could lead to personal injury, death, physical or environmental damage. Skyworks customers using or selling Skyworks products for use in such applications do so at their own risk and agree to fully indemnify Skyworks for any damages resulting from such improper use or sale.

Customers are responsible for their products and applications using Skyworks products, which may deviate from published specifications as a result of design defects, errors, or operation of products outside of published parameters or design specifications. Customers should include design and operating safeguards to minimize these and other risks. Skyworks assumes no liability for applications assistance, customer product design, or damage to any equipment resulting from the use of Skyworks products outside of stated published specifications or parameters.

Skyworks, the Skyworks symbol, and "Breakthrough Simplicity" are trademarks or registered trademarks of Skyworks Solutions, Inc., in the United States and other countries. Third-party brands and names are for identification purposes only, and are the property of their respective owners. Additional information, including relevant terms and conditions, posted at [www.skyworksinc.com](http://www.skyworksinc.com), are incorporated by reference.