

## DA7212 Ultra Low Power Codec and Power Commander™ GUI Software

### Introduction

The DA7212 Evaluation Board has been designed to allow measurement and evaluation of the DA7212 device.

All Audio Codec functionalities are self-contained within the Evaluation Board (EVB).

The EVB is supplied with a USB memory stick containing various documents and a GUI to allow the user to control the DA7212.

The GUI is called Power Commander™. It uses a simple graphical interface, allowing the DA7212 to be controlled via a USB port of a PC.

The EVB has a number of jumper links to enable the user to change the system configuration and to allow him to make appropriate measurements, although, in reality, few jumper links are required to be altered for standard operations of the DA7212.

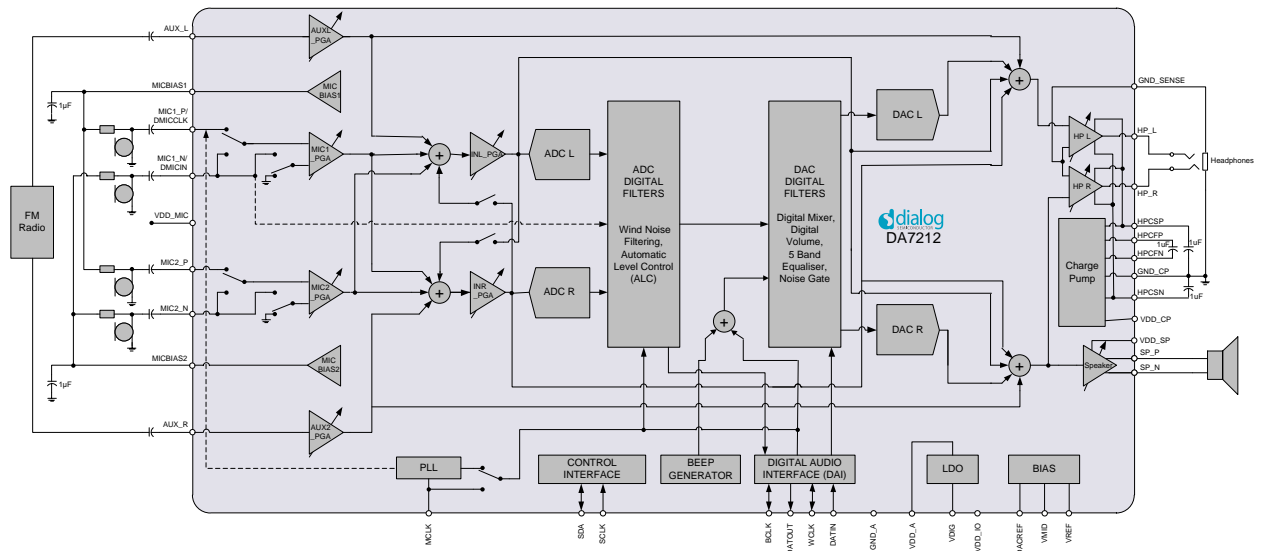

Figure :1 DA7212 Block Diagram

## Table of Contents

<b>SUMMARY</b>	<b>3</b>
<b>HARDWARE</b>	<b>4</b>
Power Supplies	6
Audio Connections	7
Jumpers Link Positions and Button Settings	8
<b>CONTROL SOFTWARE</b>	<b>11</b>
<b>Installation</b>	<b>11</b>
<b>Control Panel</b>	<b>13</b>
Status and Controls	14
<b>Control Interface</b>	<b>17</b>
<b>Codec Config Page</b>	<b>18</b>
<b>DAI and PLL Page</b>	<b>19</b>
<b>Analogue Inputs</b>	<b>20</b>
<b>Analogue Outputs</b>	<b>21</b>
<b>Mixers</b>	<b>22</b>
<b>ADC Control</b>	<b>23</b>
<b>DAC Control</b>	<b>24</b>
<b>ALC Control</b>	<b>25</b>
<b>Tone Gen</b>	<b>26</b>
<b>Codec Registers</b>	<b>27</b>
<b>TROUBLESHOOTING</b>	<b>28</b>
Software Issues	28
Hardware Issues	28
<b>APPENDIX A – REGISTER TEXT FILE</b>	<b>30</b>
<b>APPENDIX A – SOCKETED MINIBOARD (169-01-A)</b>	<b>33</b>
<b>REVISION HISTORY</b>	<b>34</b>

## Summary

This document provides some useful information to the user about the EVB and the GUI to allow testing and evaluation of the DA7212 Ultra Low Power Codec.

The hardware solution is based upon two PCBs:

- "EVALUATION MOTHERBOARD 170-03-A"
- "CUSTOMER REFERENCE BOARD 169-02-A" (DA7212 mini board)

The GUI, called Power Commander™, requires a PC operating Windows 2000/XP/Vista/Windows 7 with a USB1.1 or USB2 interface.

To run Power Commander™ under Windows Vista, set the default installation location to 'C:\Dialog Semiconductor\'.

Note that Dialog recommends connecting the EVB to a 500 mA capable USB port as we cannot guarantee that a USB hub (set to 100 mA) is sufficient to operate it correctly.

See the section on Power Supplies below.

The GUI allows the user to: (i) configure the DA7212 using one of the several pre-loaded initialisation files (i.e. start-up sequences) available; (ii) write and read operations to all control registers; and (iii) monitor of device status.

## Hardware

The DA7212 Evaluation Board consists of two boards:

A daughterboard containing the DA7212, and the essential external components. This board could also be used in standalone or as a module for a customer development platform.

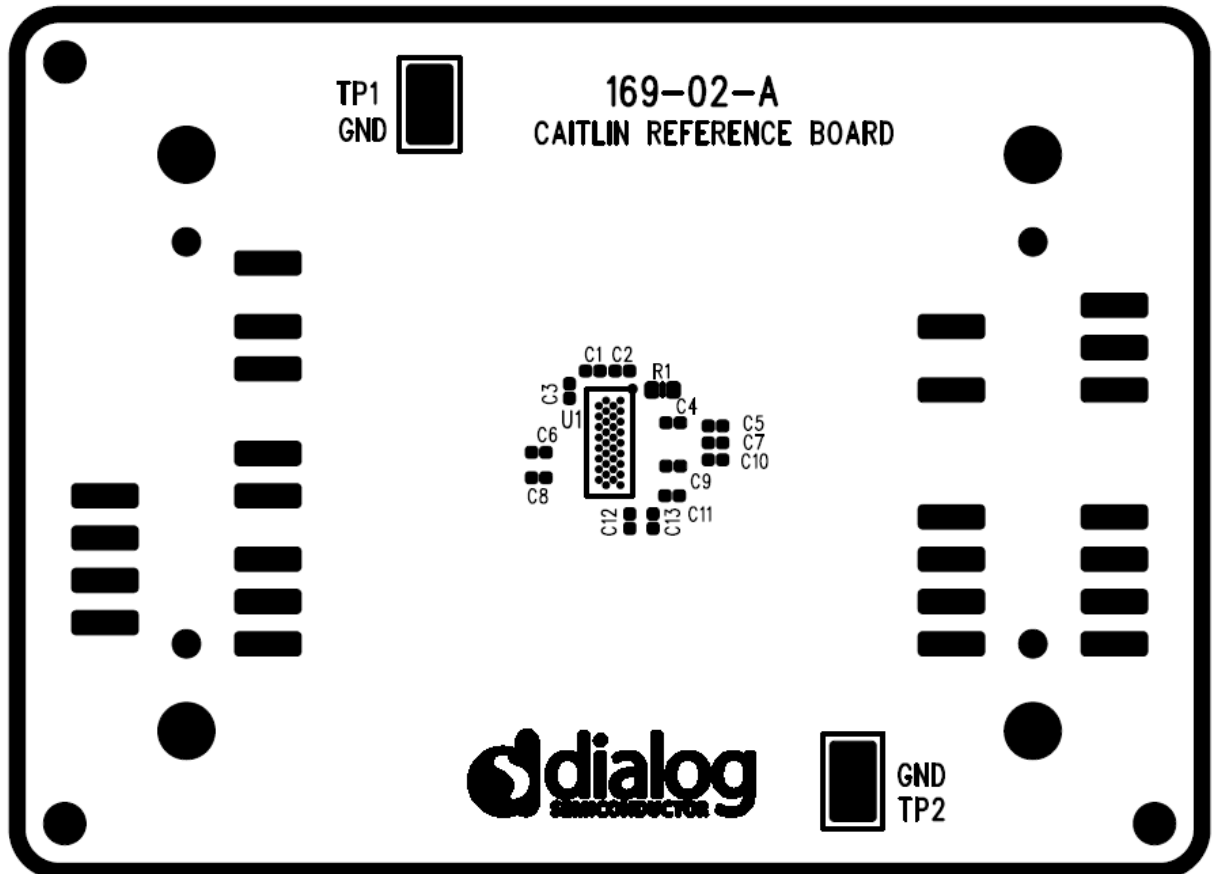

Figure 2: DA7212 Mini Board

Note a socketed mini board (169-01-A) is also available. See appendix B for more information.

A motherboard containing many circuit blocks that allows for flexible configuration and provides test access to the DA7212. It includes:

- USB Interface with Control Interface level shifters
- 1x audio optical input/output interfaces (with selection matrix)
- USB reset and 3.3V reset switches
- headphone output
- line out outputs
- auxiliary inputs
- analogue/digital microphone inputs
- master clock input
- power supply inputs (VBAT, GND)

A USB-I2C bridge is used for communication with the device, and there are a number of external active components to reduce the requirement for external circuitry.

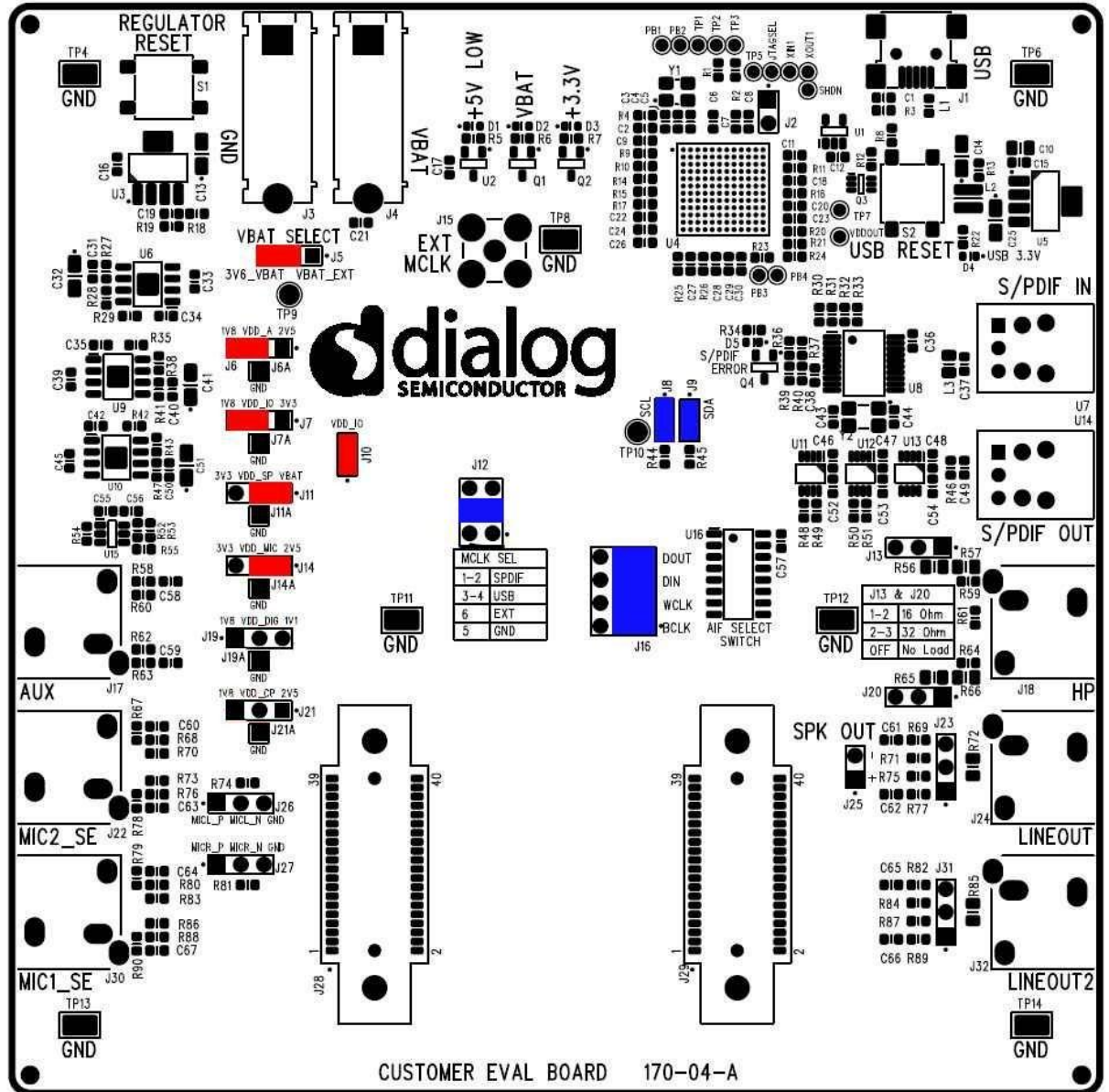
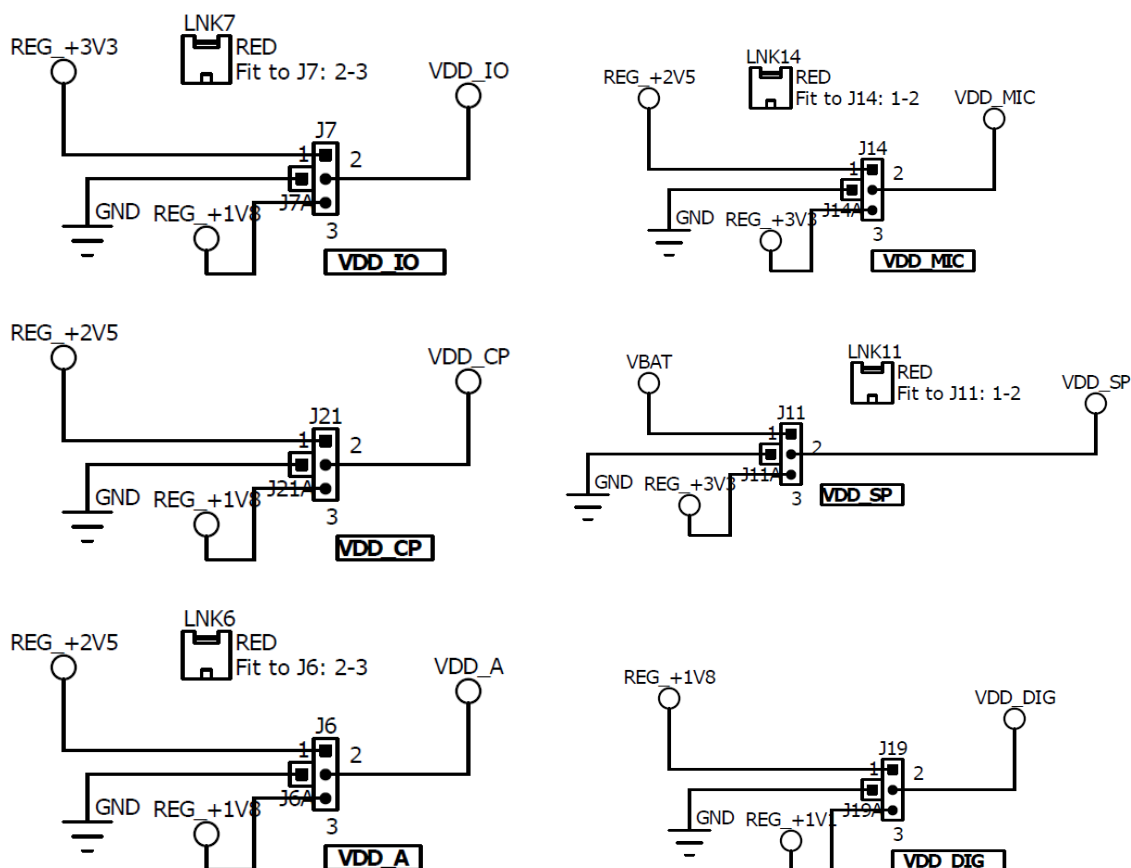

Figure 3: Mother Board – Default Jumper positions shown in Red (power) and Blue (signal)

Note: The EVB has been configured by default to work from the mother board's on-board regulators.

## Power Supplies

The DA7212 EVB is powered when a USB cable is connected to J1 (+5V\_USB). With default jumper settings (J6, J7, J11, J14 and J19, J21), the DA7212 device on the daughterboard is powered from the on-board regulators.



As DA7212 supports a wide supply range the jumper configuration allows the user to select one of two on-board supplies for each supply by connecting the jumper link between pins 1&2 or 2&3 of the jumper. For maximum flexibility the jumper link can be removed and a voltage can be supplied directly onto pin 2 of the jumper with a ground connection connected to the A pin of the jumper. Current measurements on individual supplies can also be performed by connecting an ammeter between the supply and pin2 of the jumper.

Note: As VDD\_IO supplies the IO voltage for the USB interface and level translators jumper J10 has been provided for current measurements on this supply of the DA7212 device. For current measurements on VDD\_IO remove the jumper link and insert an ammeter between pins 1 & 2 of J10.

Note: VDD\_CP and VDD\_DIG are not used in DA7212 and the jumper link should be left unpopulated.

## Audio Connections

Connector	Name	Function
J17	AUX	Stereo single-ended auxiliary input
J30	MIC1_SE	Stereo single-ended microphone input (connects to MIC1_P and MIC2_P)
J22	MIC2_SE	Stereo single-ended microphone input (connects to MIC1_N and MIC2_N)
J26		Mono differential microphone input Pin 1: MIC1_P Pin 2: MIC1_N Pin 3: GND
J27		Mono differential microphone input Pin 1: MIC2_P Pin 2: MIC2_N Pin 3: GND
U7	S/PDIF IN	Digital optical input
U14	S/PDIF OUT	Digital optical output
J18	HP	Stereo single-ended headphone output
J24	LINEOUT	Differential line output (AC coupled, use J25 for speaker)
J23		Differential line output (AC coupled, use J25 for speaker) Pin 1: LINE_P Pin 2: GND Pin 3: LINE_N
J25		Differential speaker output (DC coupled) Pin 1: SP_P Pin 2: SP_N
J32	LINEOUT2	Unused
J31		Unused

Table 1 170-04-A Audio Connectors

## Jumpers Link Positions and Button Settings

Jumper number	Position	Function
J3 & J4		External VBAT and GND connection
J5	1-2, (default)	VBAT select: VBAT is generated from an on-board regulator supplied from the USB
	2-3	VBAT select: VBAT is supplied from J3&J4
J6	1-2, (default)	Connects VDD_A from onboard 1.8V supply
	2-3	Connects VDD_A from onboard 2.5V supply
	A	GND connection for connecting external supply between pin 2 and A
J7	1-2, (default)	Connects VDD_IO from onboard 1.8V supply
	2-3	Connects VDD_IO from onboard 3.3V supply
	A	GND connection for connecting external supply between pin 2 and A
J8	On, (default)	Connects USB I2C SCLK to device
J9	On, (default)	Connects USB I2C SDATA to device
J10	On, (default)	Connects VDD_IO to the DA7212 device.
J11	1-2	Connects VDD_SP from onboard 3.3V supply
	2-3, (default)	Connects VDD_SP from VBAT
	A	GND connection for connecting external supply between pin 2 and A
J12	1-2	MCLK comes from the SPDIF interface
	3-4, (default)	MCLK comes from the USB interface
	5	GND pin
	6	External MCLK pin, an external MCLK can be connected between pins 5



		and 6.
J13	1-2	Inserts a 16ohm load across the left headphone output for test purposes
	2-3	Inserts a 32ohm load across the left headphone output for test purposes
J14	1-2	Connects VDD_MIC from onboard 3.3V supply
	2-3, (default)	Connects VDD_MIC from onboard 2.5V supply
	A	GND connection for connecting external supply between pin 2 and A
J15		Allows connection of an external MCLK using an SMB connector. J12 should have it's jumper link removed when using this option.
J16	1-2, (default)	Connects the SPDIF/USB BCLK to the DA7212 device
	3	GND for connecting BCLK to/from an external source between 2-3 (for example Audio Precision PSIA cable)
	4-5, (default)	Connects the SPDIF/USB WCLK to the DA7212 device
	6	GND for connecting WCLK to/from an external source between 5-6 (for example Audio Precision PSIA cable)
	7-8, (default)	Connects the SPDIF/USB DIN to the DA7212 device
	9	GND for connecting DIN from an external source between 8-9 (for example Audio Precision PSIA cable)
	10-11, (default)	Connects the SPDIF/USB WCLK to the DA7212 device
	12	GND for connecting DOUT to an external source between 11-12 (for example Audio Precision PSIA cable)
J19	1-2	Not Used
	2-3,	Do not connect for DA7212
	A	
J20	1-2	Inserts a 16ohm load across

		the right headphone output for test purposes
	2-3	Inserts a 32ohm load across the right headphone output for test purposes
J21	1-2, (default)	Not Used
	2-3	Do not connect for DA7212
	A	
S1		Regulator Reset button: Resets the 3.3V, 2.5V, 1.8V and 1.1V regulators
S2		USB Reset button: Resets the USB sub system

Table 2: 170-04-A Jumpers Link Positions and Button Settings

## Control Software

### Installation

From the USB memory stick provided with the EVB box, run the 'setup.exe' file (DA7212\_USB\DA7212 GUI\setup.exe).

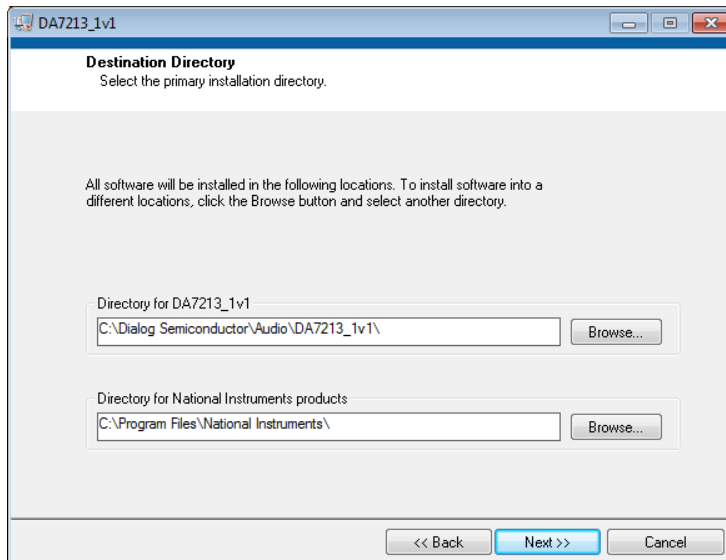

Click "Next>>".

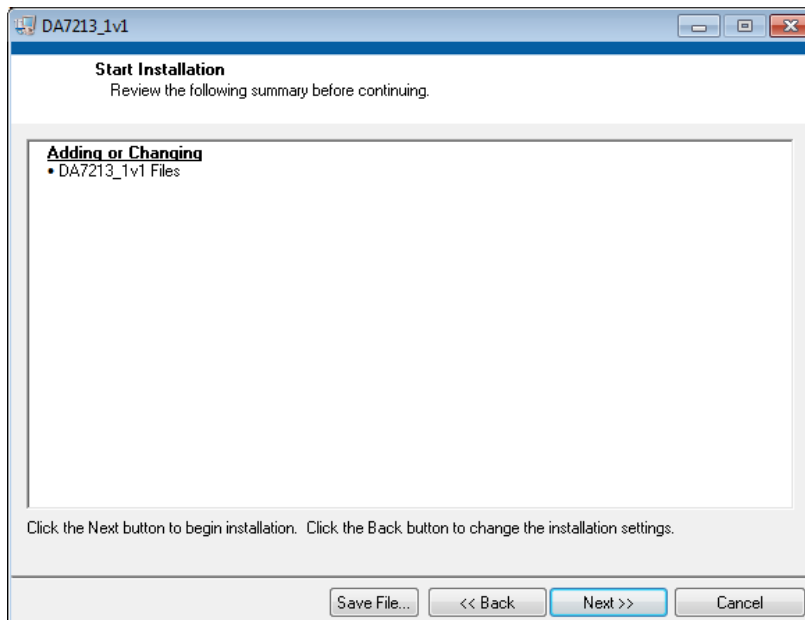

Click "Next>>".

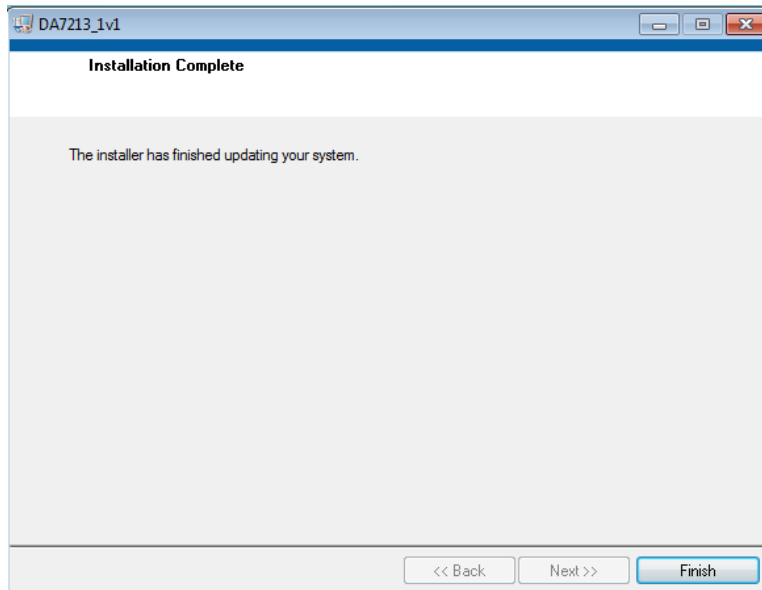

Click "Finish".

You may need to restart your computer; in this case a pop up window will appear asking you to do so.

Once your computer has restarted, plug the USB cable to the EVB and Windows should detect the USB device and automatically install the driver. If not, the driver is located on this DA7212 USB stick

## Control Panel

Run the DA7212 program by clicking the shortcut on the appropriate item in the Start menu. The best setting for the PC display size is 1024x768 pixels or above. Font size on the PC display should be Normal (95dpi). It is important to note that a display size other than the recommended setting may affect the way in which the panels appear.

The following screen appears, with the “USB OK?” LED lit if the USB interface is correctly connected and operational.

To start the device, plug in the USB cable.

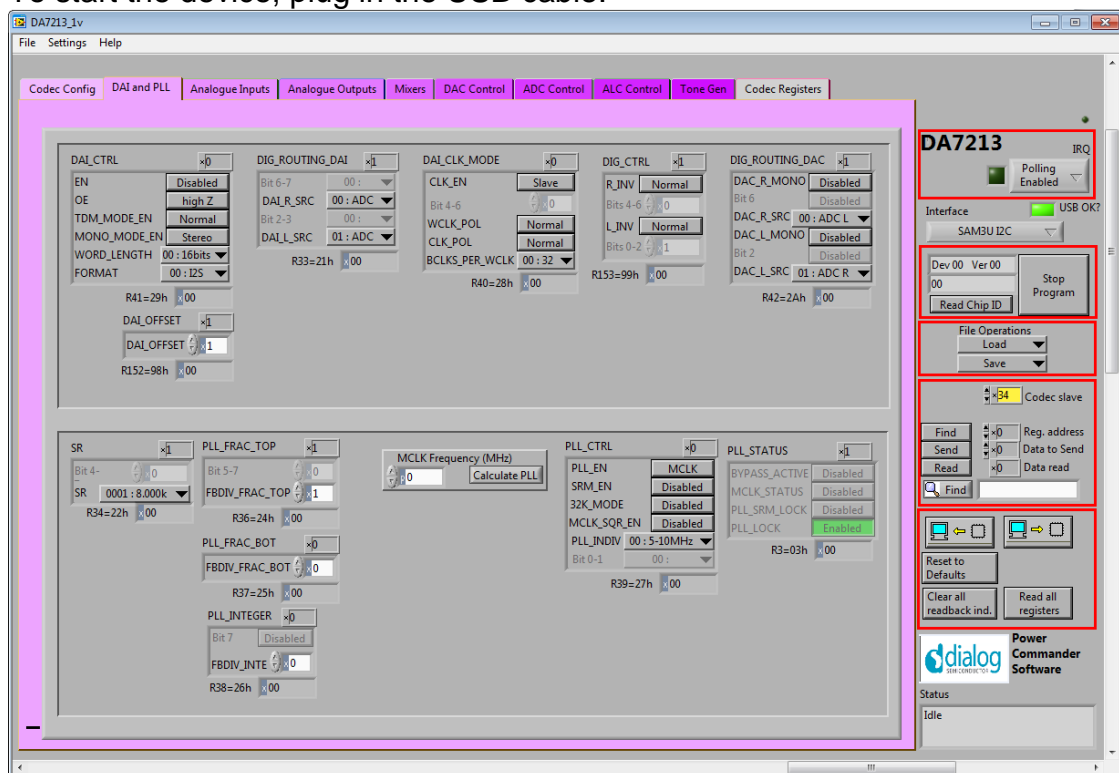

Figure 4 Initial Interface

If the Reset LED is blinking yellow, it indicates that the device is not yet communicating via the I2C interface. See Troubleshooting for more details.

## Status and Controls

### **Polling Enabled**

BY default the current page contents is updated via polling the I2C interface. If disabled, these readbacks are suppressed. This is used to force the communication over the bus to be silent. If this is set to automatic, the program will only poll the device while the application is the topmost window. If obscured by another program or window, polling will be disabled.

### **LED**

If the device is active this LED is green, or red if inactive.

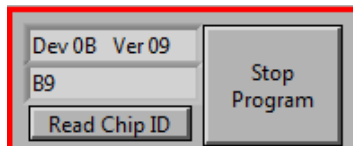

This indicates the device version when the device is active. When inactive, version status will not be correct.

### **Stop Program**

This terminates the program. If there are unsaved changes, a dialog box is displayed.

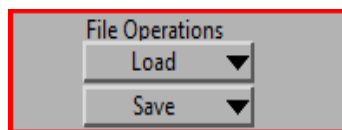

**Load** Loads previously saved text files, send all Registers and read back all registers. “Load” opens a dialog box to select, view, copy or re-name a file.

Load Codec file opens a dialog box to allow selection of a codec setup file in the “\Codec Setups” directory.

**Save** Saves current panel state to a text file. Selecting “Save Codec file..” saves the codec registers in a slightly different format. Selecting “Register Dump” option saves current register values to the text file. See Appendix A.

*Note: Difference between “Save” and “Register Dump” is that the “Save” dumps the contents of all panel controls to the file (a save state operation); whereas, “Register Dump” reads the device contents (including status registers) into the file. Note that some codec registers do not have readback capability.*



**Interface** Selects between USB I2C control and offline mode. Switching to offline, then back to USB reinitialises the USB interface.

**USB OK?** Indicates that the USB is OK and communicating.

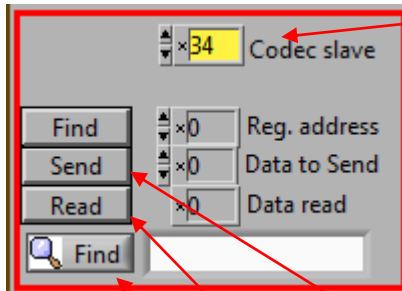

**Slave Address**

Sets slave address of device. This affects all I2C communications.

The codec slave addresses for DA7212 is 0x34. Note that this is the 8bit value (34h for Write, 35h for Read).

**Send** Sends a single byte data to I2C device using Slave Address, Register Address and Data to Send.

**Read** Reads single byte data from I2C device using Slave Address and Register Address.

**Find** Finds a control matching a full or partial register name, a control bit name, a register number (e.g. R23 or 17h). Pressing “Find” repetitively will step through all matching items.

*Note: If Device Address does not match the port numbers on the device, this can be used to control/read any other device on the I2C bus.*

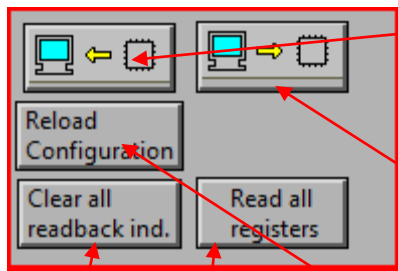

**Synchronise Panel from Device**  
Reads all the register contents of the device and updates the panel to match.

**Synchronise Device from Panel**  
Writes all the device registers to match the panel. (Refresh operation)

**Reload Configuration**  
Resets registers to values specified in configuration file for the PMIC section and default values for the codec.

**Clear all I2C readback indicators**      Sets all readback indicators to 0.

**Read All Registers**      Reads all registers, comparing with the panel controls.



## ***Control Interface***

The Codec Config, DAI and PLL, Analogue Inputs, Analogue Outputs, Mixers, DAC Control, ADC Control, ALC control and Tone Gen pages all have the same format.

Each register cluster comprises a control with a mixture of Boolean toggle buttons, multi-value ring controls, or slide controls, as well as a hexadecimal indicator showing the total equivalent register value and a readback indicator showing the current register settings. The Event Register is labeled with a Register number in decimal and its hexadecimal equivalent.

The Readback indicator readings can be switched individually to decimal, octal, hexadecimal or binary by clicking on the “x”, or they may all be changed at once between Hex and Binary by the “View>Binary Indicators” menu item.

## Codec Config Page

The Codec Config page allows access to the System Controller as well as some basic system settings such as the references, IO levels and digital LDO. To use the System Control panel (de)select the blocks as required for the inputs and outputs and click the Submit button to apply the changes. If no blocks are active then the System Active panel can be used to disable the on-chip oscillator and put DA7212 into an ultra-low power standby state. The CIF CTRL panel can be used to reset the chip and return all the registers to their hardware defaults.

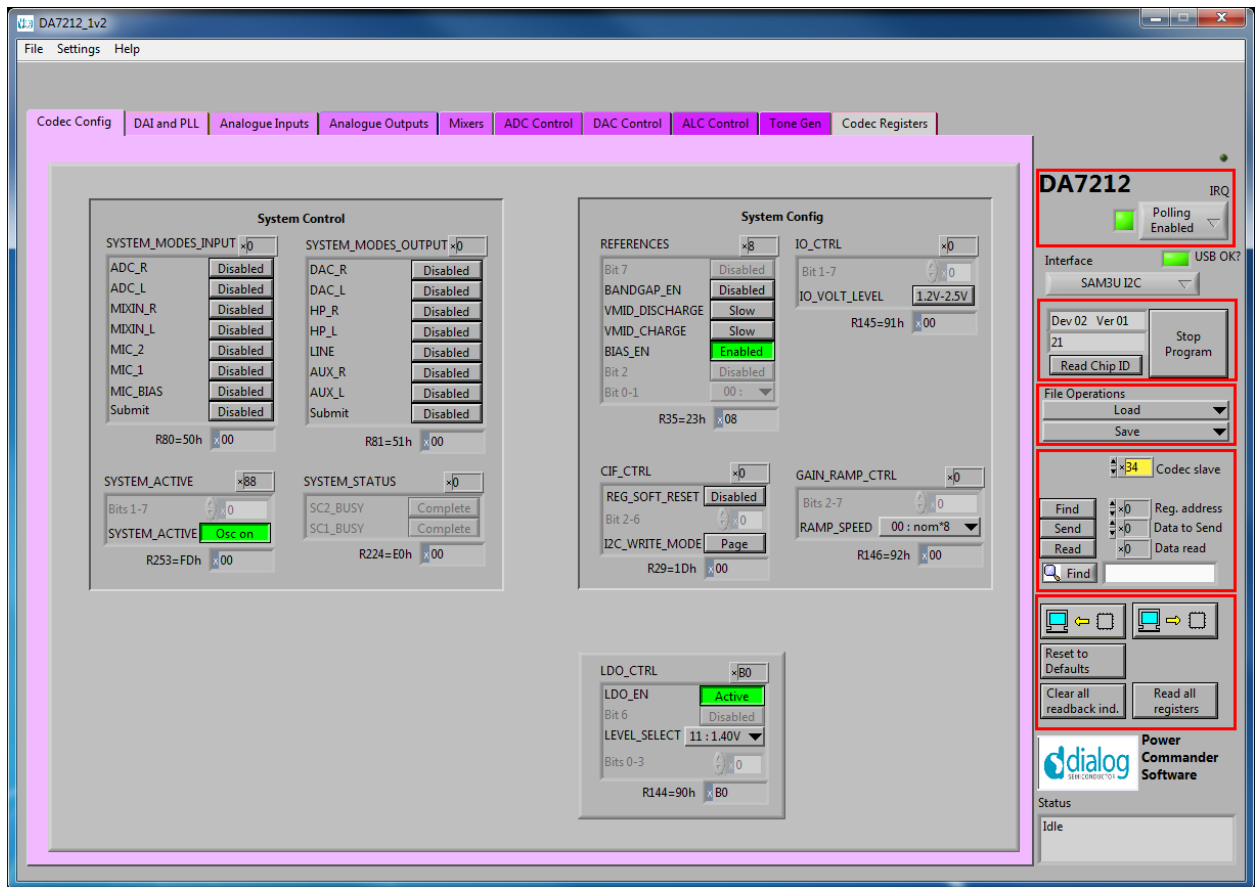

## DAI and PLL Page

The DAI and PLL page allows control of the digital audio interface and phase-locked loop. The DAI CTRL panel sets the format on the DAI and the DAI CLK MODE panel sets the master/slave mode as well as the clock polarity and number of BCLKS per WCLK. The DIG ROUTING DAI panel selects the data source for the DAI and DIG ROUTING DAC selects the data source for the DAC.

The PLL Control panel contains all the settings for the PLL and on-chip clocking. The SR panel sets the sample rate being used. The PLL CTRL panel sets the input clock rate, whether the PLL is enabled and whether sample rate matching (SRM) is required to track the DAI in slave mode. If the PLL is required, the three FB DIV panels control the value of the feedback divider. The required values can be calculated using the DA7212 PLL Calculator spreadsheet, or they can be determined automatically by entering the supplied MCLK frequency and pressing the Calculate PLL button. The current status of the PLL is shown in the PLL STATUS panel. The PC COUNT panel controls the behavior of the internal program counter.

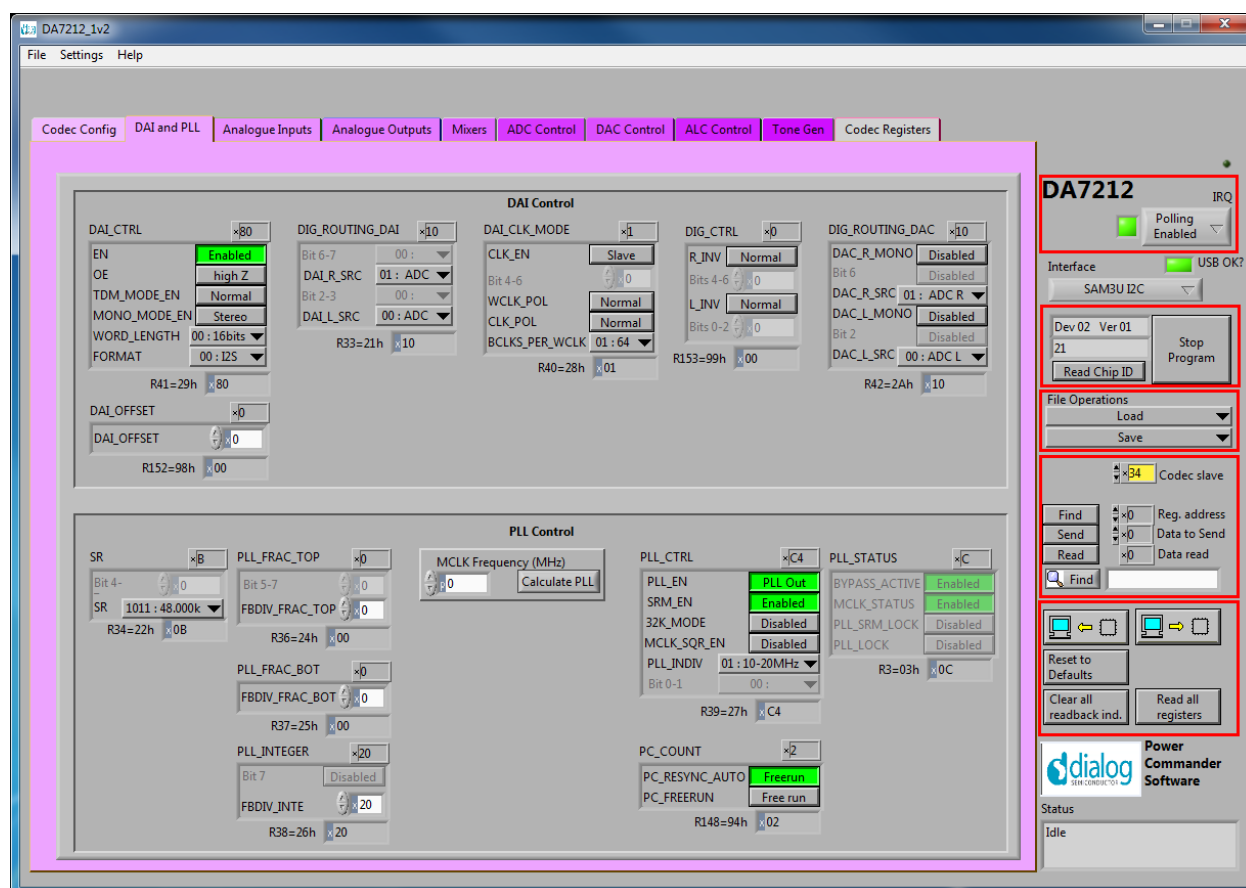

## Analogue Inputs

The Analogue Inputs page controls the input amplifiers and microphone biases. Each of the GAIN panels sets the target gain for the amplifiers, and the GAIN STATUS shows the currently active gain setting. Each of the CTRL panels sets the enable, mute, and gain change behavior (ramped or zero-crossed) for the amplifiers. The MIC CTRL panels allow selection of single-ended or differential input signal. The MICBIAS CTRL panel enables and sets the output level for the microphone bias outputs. The MIC CONFIG panel sets the clock and data format when digital microphones are used.

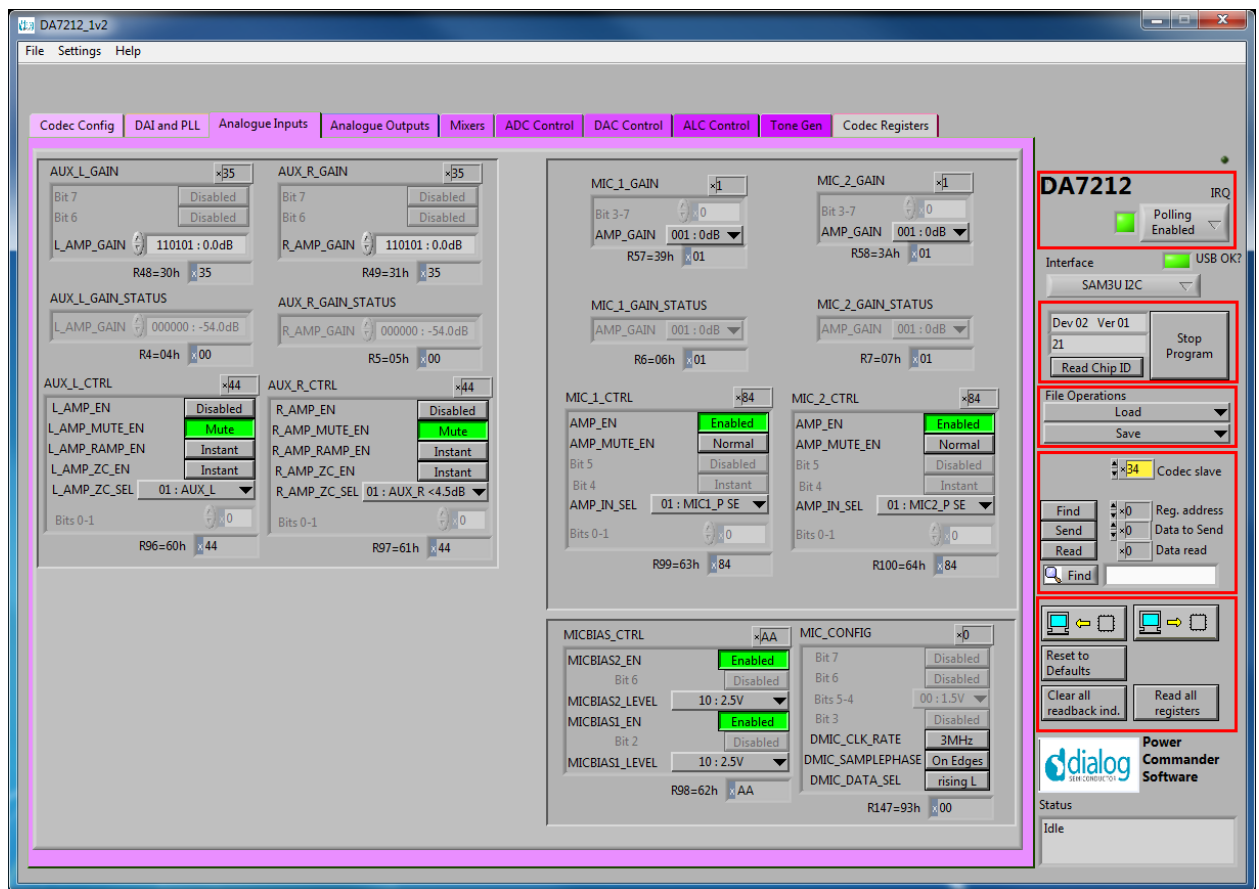

## Analogue Outputs

The Analogue Outputs page controls the headphone and line (speaker) amplifiers as well as the charge pump for the headphone supplies. The GAIN, GAIN STATUS and CTRL panels behave as for the Analogue Inputs page. The Charge Pump Control controls the mode and switching behavior of the charge pump as explained in the datasheet.

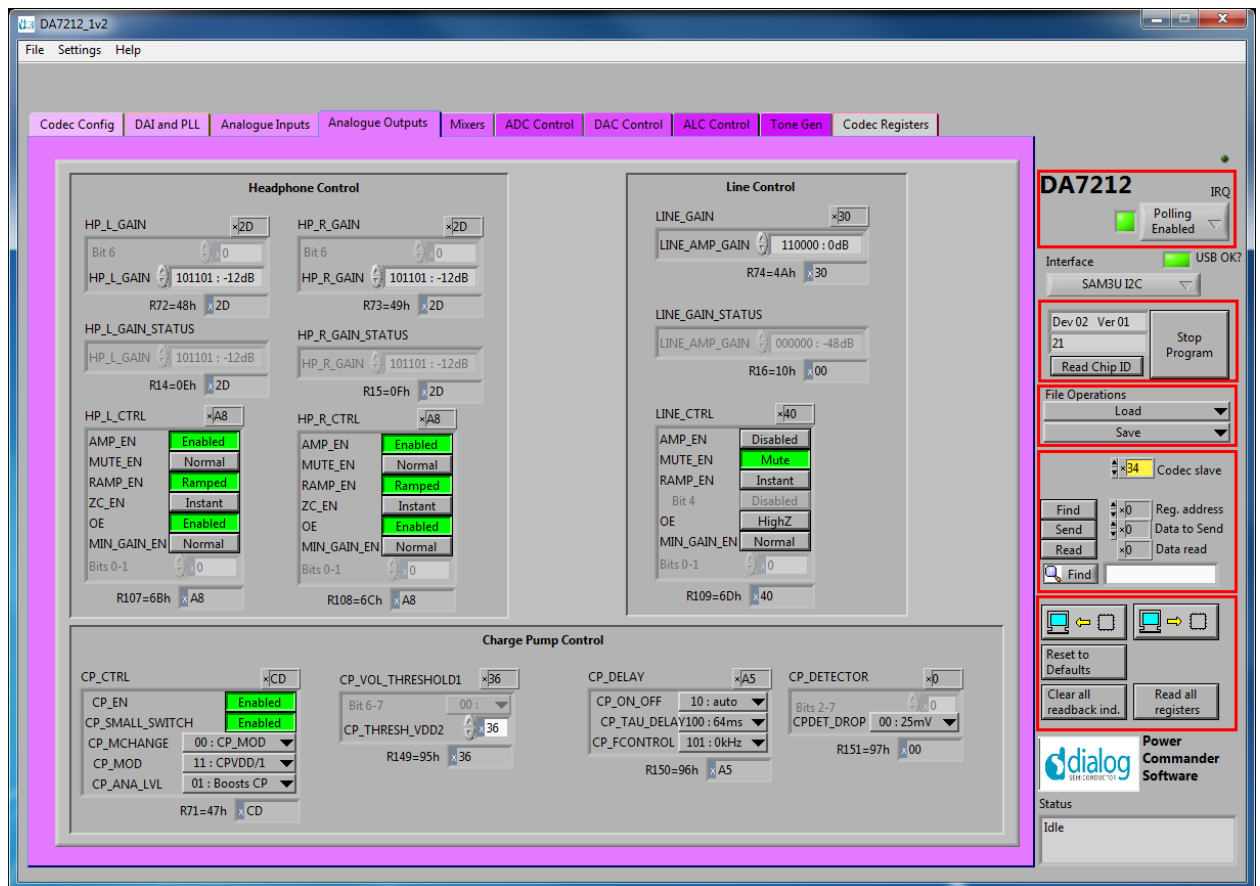

## Mixers

The Mixers page controls the behavior of the analogue input and output mixers. The GAIN, GAIN STATUS and CTRL panels behave as for the Analogue Inputs page. The MIXOUT CTRL panel also enables the Softmix feature to ramp in/out the the select inputs. The SELECT panels controls which inputs are routed to each of the four mixers.

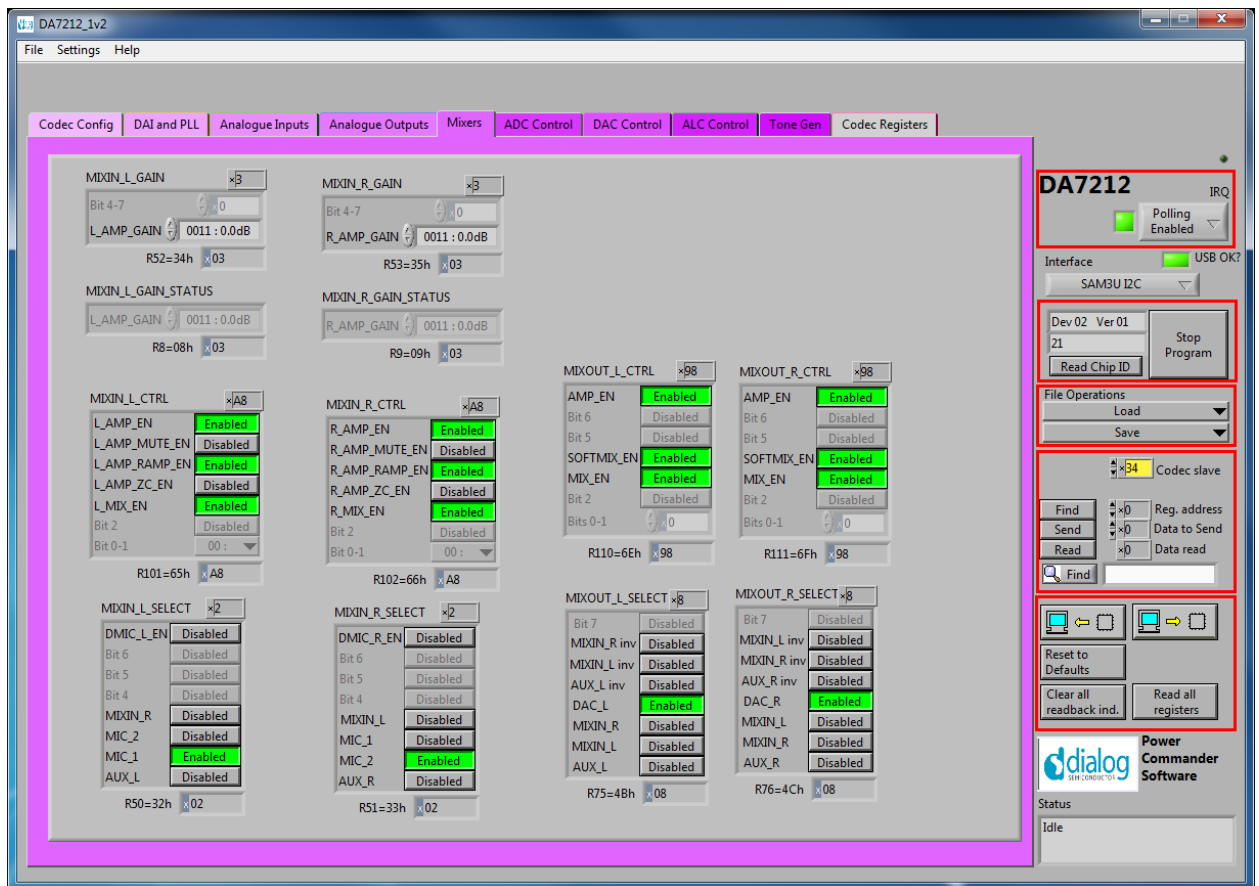

## ADC Control

The ADC Control page enables the ADC, sets the digital gain applied after the ADC and controls the behavior of the high-pass filter.

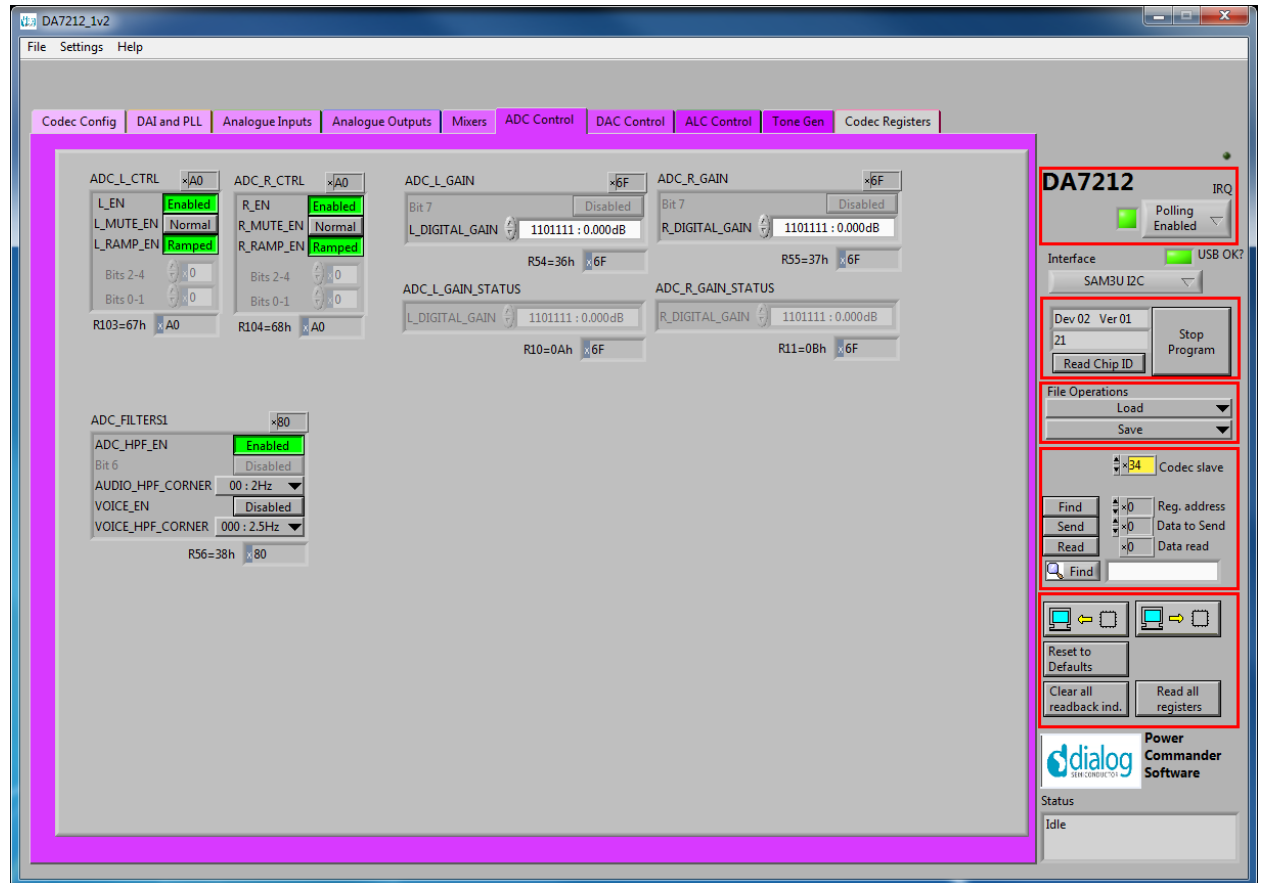

## DAC Control

The DAC Control page controls the DAC, the DAC filters and the DAC noise gate. The DAC FILTERS panels control the high-pass filter as well as the 5-band EQ filter. There is also an option to apply a soft mute to the DAC input signal. The DAC NG panels control the behavior of the DAC noise gate in terms of its on and off thresholds, attack/decay rates and hold time.

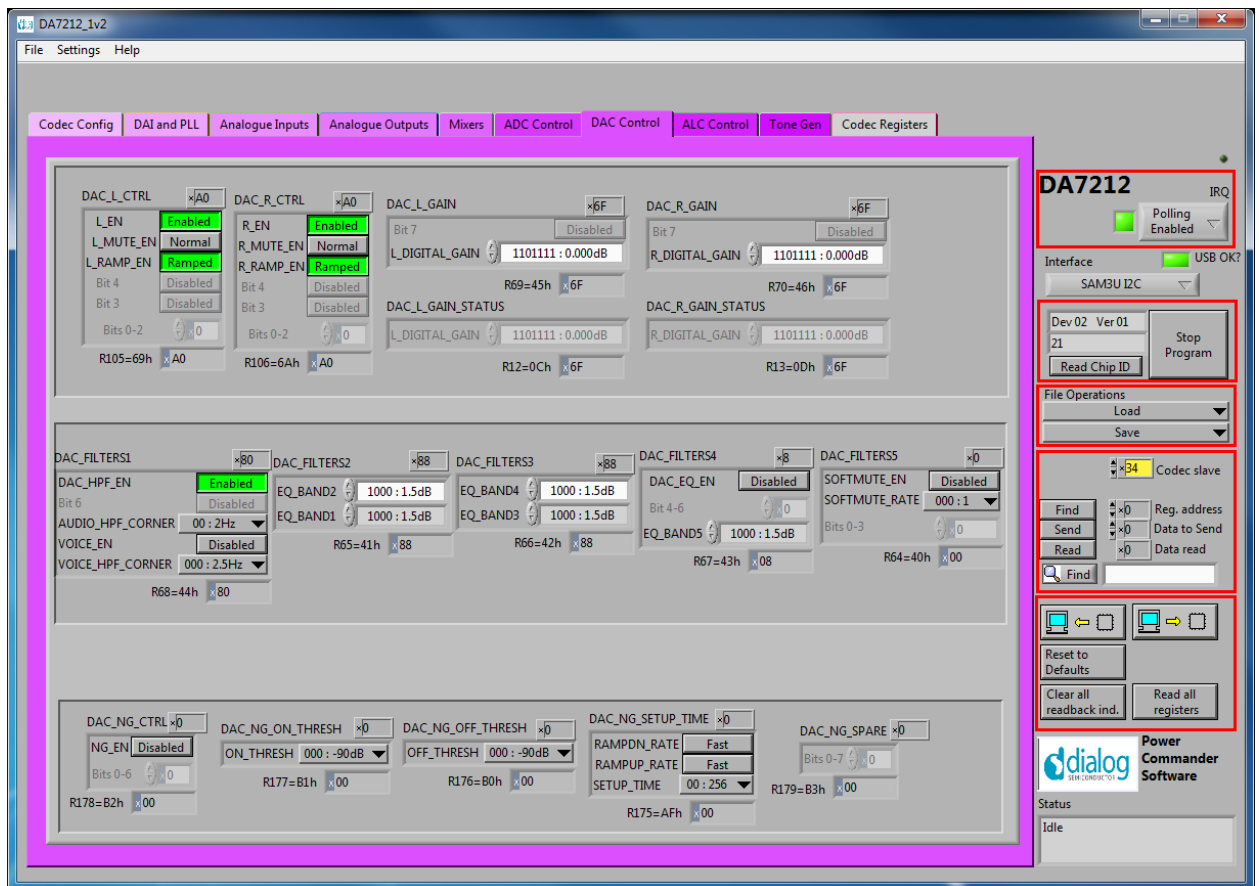



## ALC Control

The ALC Control page configures the automatic level control on the record path. The ALC behavior is described in detail in the datasheet.

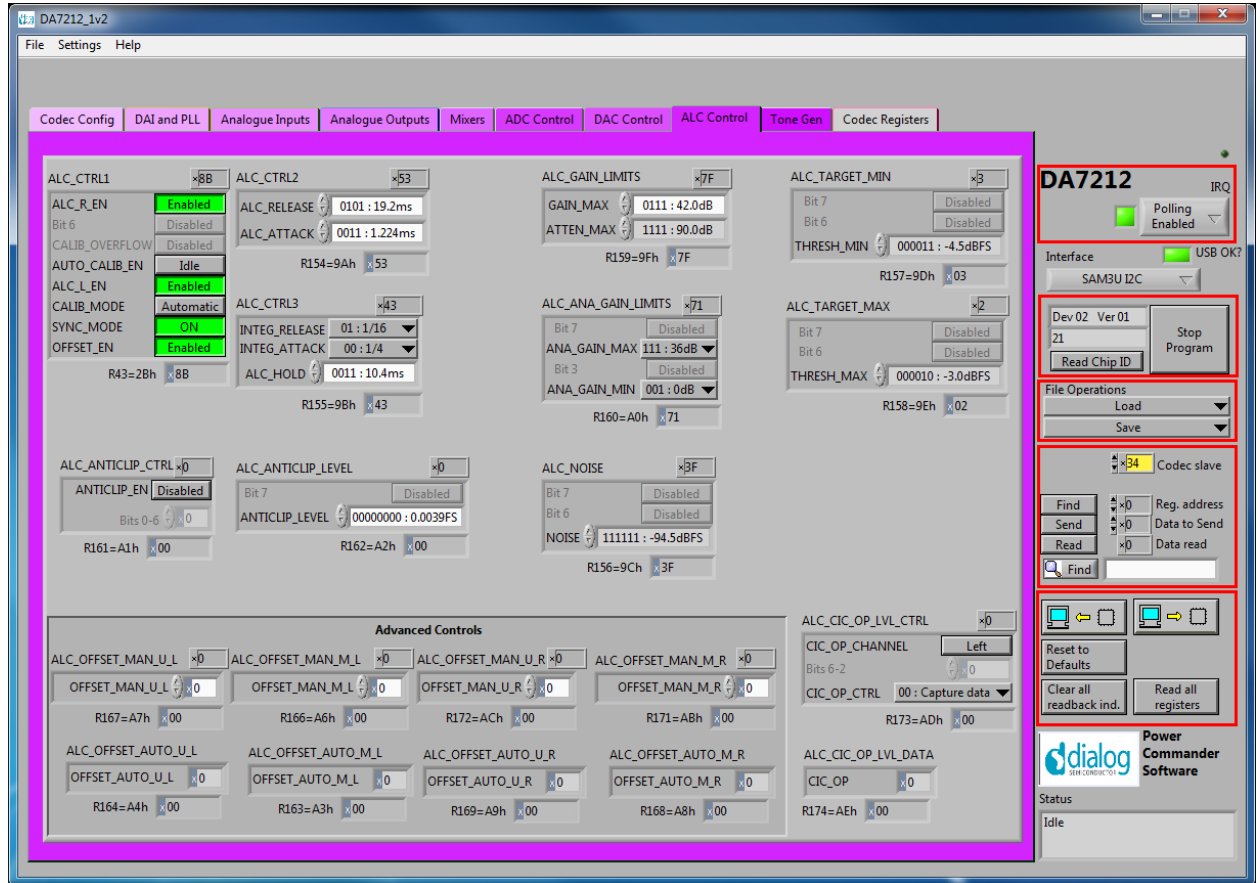

## Tone Gen

The Tone Gen page controls the digital tone generator at the input to the DAC. TONE GEN CFG1 panel starts the tone generator and enables a DTMF tone if required. TONE GEN CFG2 panel sets the gain applied to the tone and controls which sine-wave generator is used (or both). The TONE GEN FREQ panels set the frequency for the two generators as described in the datasheet. The DTMF Phone pad panel produces DTMF tones when the buttons are pressed. The TONE GEN CYCLES panel controls how many beeps are produced, and the TONE GEN ON and OFF PER panels control the on and off periods.

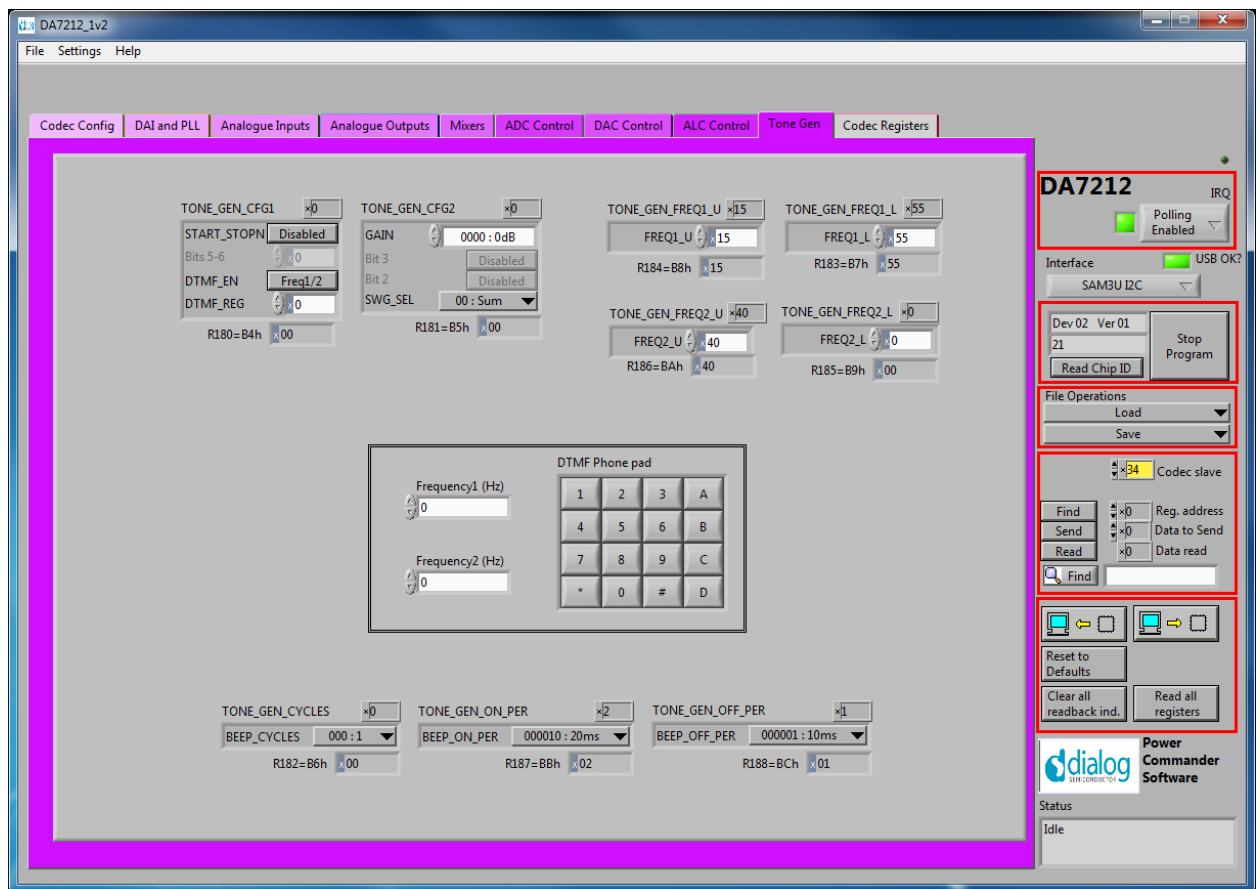

## Codec Registers

This page presents the registers in a single table. The table is interactive, both receiving changes made in other controls, and passing values to other controls if changed in the table. In some conditions this register view may be useful.

The screenshot shows the DA7212 software interface. The main window is titled "DA7213\_1v" and has a menu bar with "File", "Settings", and "Help". Below the menu bar is a toolbar with tabs for "Codec Config", "DAI and PLL", "Analogue Inputs", "Analogue Outputs", "Mixers", "DAC Control", "ADC Control", "ALC Control", "Tone Gen", and "Codec Registers".

The "Codec Registers" tab is active, displaying two tables: "Codec Table" and "Codec Register Map".

**Codec Table**

Input	Readbac	Default
0x07c		0x00
0x07e		0x00
0x07f		0x00
0x07d		0x00
0x07b		0x00
0x07a		0x00
0x079		0x00
0x078		0x00
0x077		0x00
0x076		0x00
0x075		0x00
0x074		0x00
0x073		0x00
0x072		0x00
0x071		0x00
0x070		0x00
0x06f		0x00
0x06e		0x00
0x06d		0x00
0x06c		0x00
0x06b		0x00
0x06a		0x00
0x069		0x00
0x068		0x00
0x067		0x00
0x066		0x00
0x065		0x00
0x064		0x00
0x063		0x00
0x062		0x00
0x061		0x00
0x060		0x00
0x05f		0x00
0x05e		0x00
0x05d		0x00
0x05c		0x00
0x05b		0x00
0x05a		0x00
0x059		0x00
0x058		0x00
0x057		0x00
0x056		0x00
0x055		0x00
0x054		0x00
0x053		0x00
0x052		0x00
0x051		0x00
0x050		0x00
0x04f		0x00
0x04e		0x00
0x04d		0x00
0x04c		0x00
0x04b		0x00
0x04a		0x00
0x049		0x00
0x048		0x00
0x047		0x00
0x046		0x00
0x045		0x00
0x044		0x00
0x043		0x00
0x042		0x00
0x041		0x00
0x040		0x00
0x03f		0x00
0x03e		0x00
0x03d		0x00
0x03c		0x00
0x03b		0x00
0x03a		0x00
0x039		0x00
0x038		0x00
0x037		0x00
0x036		0x00
0x035		0x00
0x034		0x00
0x033		0x00
0x032		0x00
0x031		0x00
0x030		0x00
0x02f		0x00
0x02e		0x00
0x02d		0x00
0x02c		0x00
0x02b		0x00
0x02a		0x00
0x029		0x00
0x028		0x00
0x027		0x00
0x026		0x00
0x025		0x00
0x024		0x00
0x023		0x00
0x022		0x00
0x021		0x00
0x020		0x00
0x01f		0x00
0x01e		0x00
0x01d		0x00
0x01c		0x00
0x01b		0x00
0x01a		0x00
0x019		0x00
0x018		0x00
0x017		0x00
0x016		0x00
0x015		0x00
0x014		0x00
0x013		0x00
0x012		0x00
0x011		0x00
0x010		0x00
0x00f		0x00
0x00e		0x00
0x00d		0x00
0x00c		0x00
0x00b		0x00
0x00a		0x00
0x009		0x00
0x008		0x00
0x007		0x00
0x006		0x00
0x005		0x00
0x004		0x00
0x003		0x00
0x002		0x00
0x001		0x00
0x000		0x00

**Codec Register Map**

Register	Value	Bit Field
0x05		alc_offset_wd2_m1(7:0)
0x06		alc_offset_wd2_m1(7:0)
0x07		alc_offset_wd2_m1(6:0)
0x08		alc_offset_wd2_m1(7:0)
0x09		alc_offset_wd2_m1(6:0)
0x0a		alc_offset_wd2_m1(7:0)
0x0b		alc_offset_wd2_m1(6:0)
0x0c		alc_offset_wd2_m1(7:0)
0x0d		alc_offset_wd2_m1(6:0)
PAGE0	REG_PAGE	
CONTROL	REG_SOFT_RESET	WRITE_MODE
UNLOCK		RESERVED(7:0)
SYSTEM_MODES	DAC_MODE(7:4)	ADC_MODE(3:0)
SYSTEM_TEST		SO_OVERRIDE
PLL_TEST		PLL_TEST2(7:2)
		PLL_TEST2
		PLL_TEST1
PLL_SRPL_TEST		PLL_SRPL_TEST2(0)
OP_TEST1		OP_TEST(7:0)
OP_TEST2		OP_TEST2(4:0)
OP_TEST3		OP_LIMIT(7:0)
OP_TEST4		OP_OPT1EN
		OP_OPT1MOD
		OP_OPT1FRQ
		OP_OPT1LEV
DHMC_CTRL	DHMC_L_EN	DHMC_L_EN
DHMC_DATA_CTRL		DHMC_CLK_RATE(6)
		DHMC_SAMPLE(5)
		DHMC_DATA_SEL
PAGE1	REG_PAGE	
DIG_TESTMUIH	DIG_TEST_MUIH(4)	DIG_TEST_MUIH_ADDR(3:0)
ADC_TEST		ADC_TEST(7:0)
ADC_BIAS_TRIM1		ADC_BIAS_TRIM(7:0)
HPAMP_TEST		HPAMP_TEST(4:0)
LINE_TEST		LINE_TEST2(0)

Buttons: Refresh Codec table, Read All, Read\_Registers

**Right Sidebar:**

- DA7213: Polling Enabled, IRQ
- Interface: SAM3U I2C, USB OK?
- Dev 00 Ver 00: Read Chip ID, Stop Program
- File Operations: Load, Save
- #34 Codec slave: Find, Send, Read, Find
- Reset to Defaults, Clear all readback ind., Read all registers
- dialog SEMICONDUCTOR Power Commander Software
- Status: Idle

## Troubleshooting

This section is an aid to resolving problems occurring in the previous sections.

### Software Issues

The USB device should install without difficulty automatically. Make sure that the installation finds and uses the driver contained in the USB memory stick.

If the program is started before the USB Interface board is plugged in, the program will default to the offline mode. It can be useful to familiarise yourself with the software in a desk environment without the hardware attached. If the board is subsequently attached, move the Interface control to “USB”. Make sure the USB is connected and then restart the program.

The software is optimized for a display screen size of 1024 by 768 pixels or greater, with Fonts set to Normal (96dpi).

There have been reported issues of unpredictable display effects when large fonts (120dpi) are used. This can be changed by right-clicking on the desktop, select Properties. Select the Settings tab, select Advanced, then Normal size from the drop-down box.

If communications are apparently lost, first press the “Start Device” button. This attempts to make the device go active.

Also switching the “Interface mode” to Offline, then back to USB can reinitialize the USB interface. Last resort is to unplug the USB then reconnect. The software will detect this and reinitialize.

### Hardware Issues

Most hardware problems can be traced to incorrect jumper positions.

Check carefully jumper positions by comparing them with the default positions on page 7. Use the jumper table details and the board schematic as a guide to the jumper functions and locations.

### Selecting USB playback

The dialog DA7212 EVB coupled with the digital IO board allows a number of audio sources to be selected with ease for testing and evaluation. One example is to stream audio from a PC to the EVB over USB, This can easily be done in the following way.

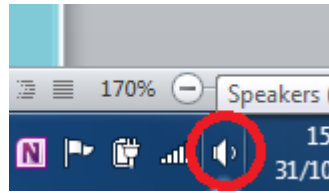

Right click on speaker symbol in task bar, circled in red

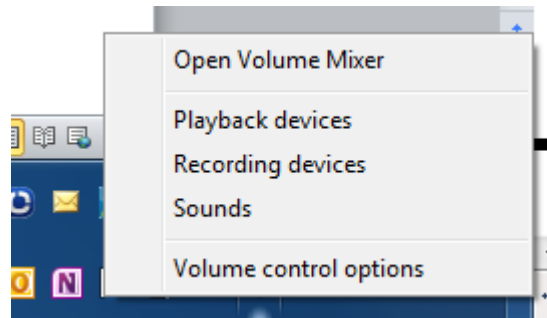

Select playback devices

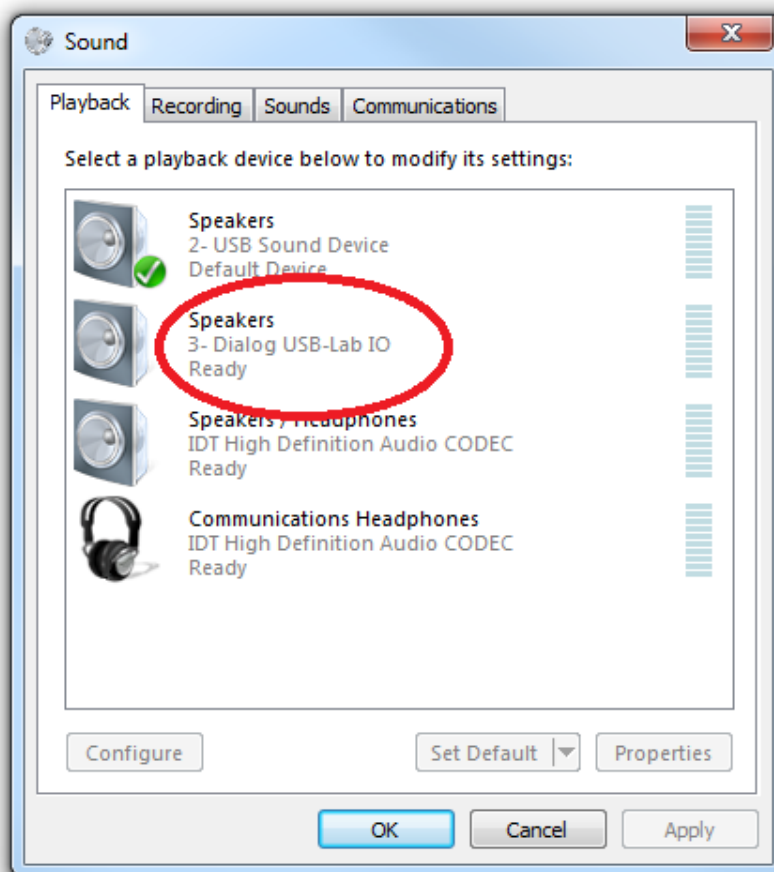

Left click on Dialog US-Lab IO, then select “Set Default” and OK.

Audio played on the PC will now be streamed over USB to the digital IO board for use on the DA7212 board.

## Appendix A – Register Text File

The software includes the ability to save and load a text file containing command codes representing the register addresses and data. This file is principally used to save and load setup data, but may also be used to perform a small degree of automation.

*Note that at the end of the startup process, initiated by pressing “Start Device”, a file “Host\_configuration.txt” is loaded and run to emulate the host processor writing immediately to the device.*

If the option “Settings>Reg names in file” is set from the menu, register names, rather than numbers, are used in the file, and the slave address is replaced by the word “CODEC”. This is generally preferable and more readable. Names are defined in the files “Registers\_DA7212.h”, and “Hardware\_DA7212.h” that reside in the \Data\Drivers directory. Hex codes for slave address and register address are still accepted on reading in the file.

The use of the Save\logtest.txt facility permits register contents to be transferred to the user’s own software. Clicking on Save\logtest.txt brings up the following panel, showing the location and name of the saved file. This is a Register dump of the entire device.

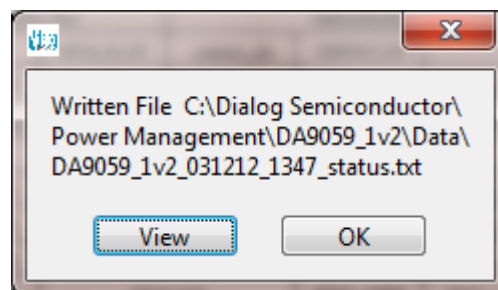

Example message box.

## I2C Register Text File Format

The following formats are used for both read and write in the text file.

- Numbers apart from time delays are always expressed in Hex, separated by tabs. The use of “0x” in front of the hex value is optional.
- The first parameter is the device slave address in 8bit format. **OR**
- The first parameter is a token:
  - “WRITE2” or “CODEC” will write to the CODEC device at the currently selected slave address (I2C mode only).
  - “READ2” will read from the CODEC device at the values of a number of registers.

- “DELAY” or “WAIT” will implement a time delay specified up to 65535 milliseconds. The delay time is specified in decimal or hex if preceded by “0x”.
  - ITERATE will cause the **whole** script to be repeated the specified number of times.
- 
- The second parameter is the register address as a name or hex value.
  - The third parameter is the data.
  - Comments (i.e. lines beginning with ‘//’) are permitted in the file.
  - Inline comments (i.e. //comment) are permitted.
  - The data will be processed in the order written and written directly to the specified device. The screen controls will be updated once command in the file have finished.
  - The use of the slave address in the file allows any device attached to the I2C bus to be controlled.
  - For read operations, the result of the read is passed to the history log window.

Example files contents:

```
//Write to CODEC in 3 ways
CODEC MIC_L 0x01
WRITE2 MIC_R 0x02
0x34 0x09 0xB1

//Read CODEC starting at DAC_R
// for next 10 registers
//Result is visible in Datalog window

READ2 DAC_R 10

//Wait 255ms
DELAY 255
WAIT 0xFF
```

Alternative form

```
//Register Dump
//Slave  Register  Data
0x92    0x01    0x00
0x92    0x02    0x01
0x92    0x03    0x02
0x92    0x04    0x02
0x92    0x05    0x04
0x92    0x06    0x05
0x92    0x07    0x06
0x92    0x08    0x07
0x92    0x09    0x08
```

The results in the history log file are shown below.

The Read operations are in brackets following the command.

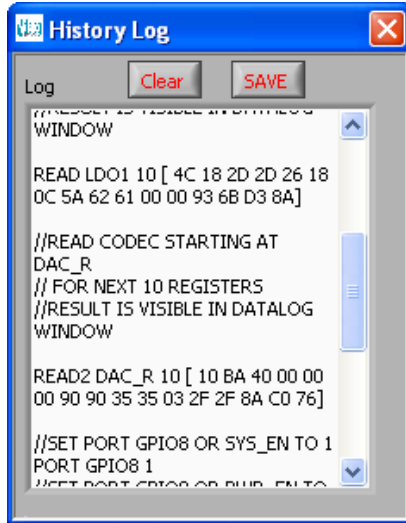



## Appendix A – Socketed Miniboard (169-01-A)

A socketed miniboard is available for evaluation purposes. This PCB uses larger passive components (0402) to allow for customer experimentation. A soldered device can replace the socket on request.

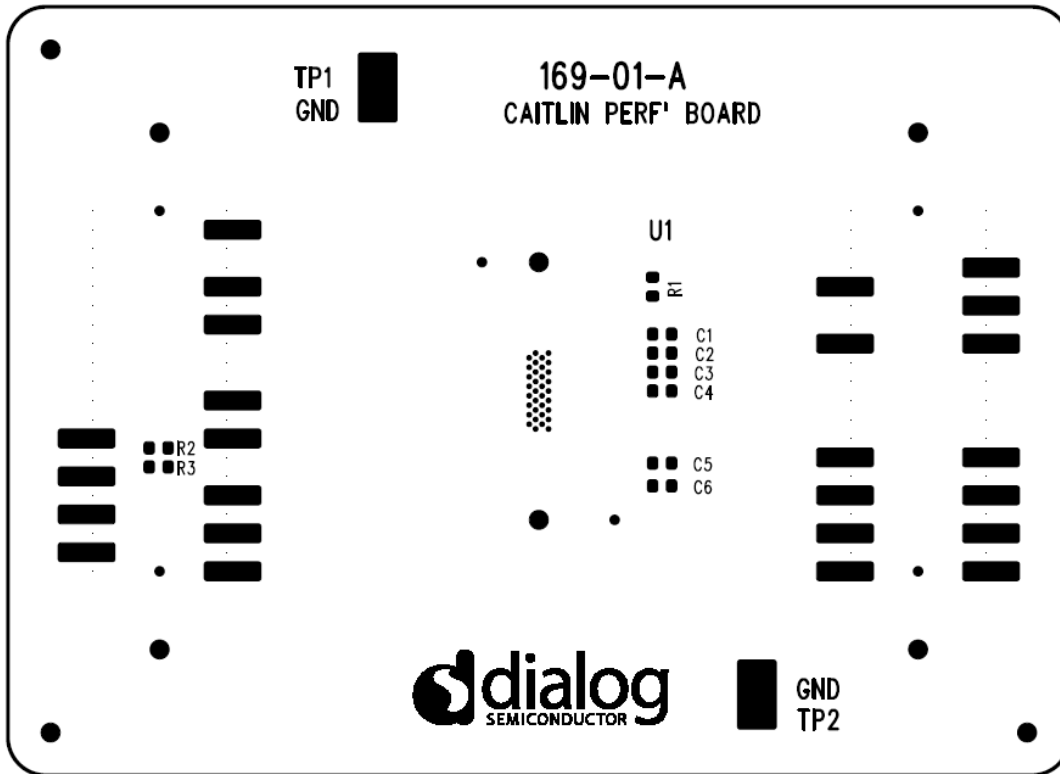

Figure 5 DA7212 Mini Board

## REVISION HISTORY

REVISION	DATE	ORIGINATOR	CHANGE
1.0	28/06/2013	CM	Initial Release
1.1	20/11/2013	CM	Updated default jumper locations
1.2	21/11/2013	PH	Added description for each page in the GUI

---

**Dialog Semiconductor Worldwide**

---

**Germany (Headquarter)**  
Tel: (+49) 7021 805-0  
Fax (+49) 7021 805-100

**USA**  
Tel: (+1) 949 623 8686  
Fax: (+1) 949 623 8305

**United Kingdom**  
Tel: (+44) 1793 757700  
Fax: (+44) 1793 757800

**China**  
Tel: (+852) 2607 4271  
Fax: (+852) 2607 4169

**Japan**  
Tel: +81-3-3215-5123  
Fax +81-3-3125-5124

**Taiwan**  
Tel: +886 22 67 57 876  
Fax +886 22 67 54 098

This publication is issued to provide outline information only, which (unless agreed by Dialog Semiconductor in writing) may not be used, applied or reproduced for any purpose or form part of any order or contract or be regarded as a representation relating to products or services concerned. Dialog Semiconductor reserves the right to alter without notice the specification, design, price or conditions of supply of the product. Customer takes note that Dialog Semiconductor's products are not designed for use in devices or systems intended for supporting or monitoring life nor for surgical implants into the body. Customer shall notify the company of any such intended use so that Dialog Semiconductor may determine suitability. Customer agrees to indemnify Dialog Semiconductor for all damages that may be incurred due to use without the company's prior written permission of products in such

Email: [enquiry@diasemi.com](mailto:enquiry@diasemi.com)

[www.dialog-semiconductor.com](http://www.dialog-semiconductor.com)