

PolySwitch Resettable Devices Strap Battery Devices

TE Circuit Protection, a pioneer of polymeric positive temperature coefficient resettable devices, has developed several material platforms to help protect battery applications. Each of these material platforms offers different performance characteristics, allowing the engineer greater design flexibility. PolySwitch devices for battery protection include SRP, LR4, VTP, VLP, VLR and MXP series, disc, and special application strap devices.

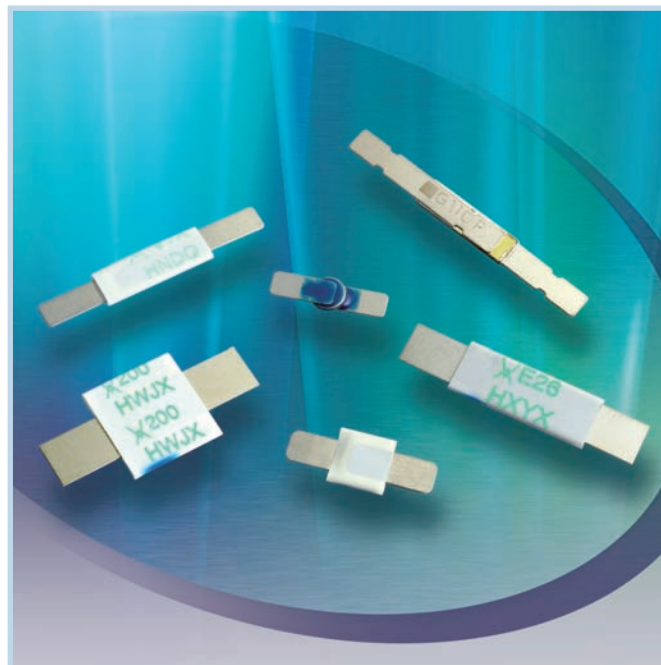

Benefits

- Many material platforms and device form factors give engineers more design flexibility
- Compatible with high-volume electronics assembly
- Assists in meeting regulatory requirements
- Low resistance devices increase battery operating time

Features

- RoHS compliant
- Lead free versions of all devices are available
- Broad range of resettable devices available
- Current ratings from 1.1A to 13A
- Voltage ratings from 6V to 30V
- Agency recognition, UL, CSA, TÜV
- Fast time-to-trip
- Low resistance

Applications

- Mobile phone and smart phone battery packs
- Tablet PC battery packs
- Mobile radio battery packs
- Computer battery packs
- Digital camera battery packs
- Portable media player battery packs
- Power tools (charge line)

Application Selection Guide for Strap Battery Devices

The guide below lists PolySwitch strap battery devices which are typically used in these applications. The following pages contain the specifications for the part numbers recommended below. Once a device is selected, the user should evaluate and test each product for its intended application.

Protection Application	Additional Comments	PolySwitch Resettable Devices — Key Device Selection Criteria			
		Installation Method	Lowest Resistance	Lowest Thermal Cut-off	
Mobile phone battery packs	Li-ion	Surface Mount	refer to Surface-mount section of this catalog		
		Prismatic	MXP370BD	VLR175F	
Cordless phone battery packs	NiMH	Cylindrical	VLP210F	—	
			SRP175F	—	
Mobile radio battery packs	NiMH	Cylindrical	LR4-380F	—	
			SRP350F	—	
Computer battery packs	NiMH	Cylindrical	LR4-900F	—	
		Li-ion	Cylindrical	LR4-1300SSF	—
			Prismatic	Consult local Rep	Consult local Rep
Camcorder battery packs	NiMH or Li-ion	Prismatic	VLP270F	VTP210GF	
			LR4-380F	—	
PDA battery packs	Li-ion	Prismatic	VLP220F	VLR175F	
Power tools (charge line)	NiCd, NiMH or Li-ion	Cylindrical	custom LR4	custom VTP	

Table B1 Product Series - Current Rating, Voltage Rating / Typical Resistance for Strap Battery Devices

Hold Current (A)	VLR	VLP	VTP	MXP	SRP	LR4
	Typical Activation Temperature		90°C	120°C	125°C	125°C
	85°C	90°C				
1.10	—	—	16V/0.054Ω	—	—	—
1.20	—	16V/0.053Ω	—	—	15V/0.123Ω	—
1.70	12V/0.025Ω	—	16V/0.041Ω	—	—	—
1.75	12V/0.024Ω	16V/0.040Ω	16V/0.040Ω	—	15V/0.070Ω	—
1.90	—	—	—	6V/0.010Ω	—	15V/0.056Ω
2.00	—	—	—	—	30V/0.045Ω	—
2.10	—	16V/0.024Ω	16V/0.024Ω	—	—	—
2.20	—	16V/0.023Ω	—	—	—	—
2.30	12V/0.015Ω	—	—	—	—	—
2.60	—	—	—	—	—	15V/0.031Ω
2.70	—	16V/0.015Ω	—	—	—	—
3.50	—	—	—	—	30V/0.024Ω	—
3.70	—	—	—	6V/0.013Ω	—	—
3.80	—	—	—	—	—	15V/0.020Ω
4.20	—	—	—	—	30V/0.018Ω	—
4.50	—	—	—	—	—	20V/0.016Ω
5.50	—	—	—	—	—	20V/0.013Ω
6.00	—	—	—	—	—	20V/0.011Ω
7.30	—	—	—	—	—	20V/0.009Ω
9.00	—	—	—	—	—	20V/0.008Ω
13.00	—	—	—	—	—	20V/0.006Ω

**Table B2 Thermal Derating for Strap Battery Devices
[Hold Current (A) at Ambient Temperature (°C)]**

Part Number	Maximum Ambient Temperature										
	-40°C	-20°C	0°C	20°C	25°C	40°C	50°C	60°C	70°C	80°C	85°C
85°C Typical Activation											
VLR*											
VLR170F	3.5	2.9	2.4	1.84	1.70	1.2	1.0	0.7	0.3	—	—
VLR170LF	3.5	2.9	2.4	1.84	1.70	1.2	1.0	0.7	0.3	—	—
VLR170UF	3.5	2.9	2.4	1.84	1.70	1.2	1.0	0.7	0.3	—	—
VLR175F	3.5	2.9	2.4	1.87	1.75	1.3	1.0	0.8	0.3	—	—
VLR175LF	3.5	2.9	2.4	1.87	1.75	1.3	1.0	0.8	0.3	—	—
VLR175UF	3.5	2.9	2.4	1.87	1.75	1.3	1.0	0.8	0.3	—	—
VLR230F	5.0	4.2	3.4	2.52	2.30	1.7	1.3	0.9	0.4	—	—
90°C Typical Activation											
VLP*											
VLP120UF	2.4	2.1	1.8	1.30	1.20	1.0	0.7	0.6	0.3	0.2	0.1
VLP175UF	3.2	2.7	2.3	1.70	1.75	1.2	1.0	0.8	0.5	0.2	0.1
VLP210F	4.3	3.6	2.9	2.31	2.10	1.6	1.3	1.0	0.6	0.3	0.1
VLP220F	4.5	3.8	3.0	2.45	2.20	1.7	1.4	1.1	0.7	0.3	0.1
VLP270F	5.6	4.7	4.0	3.05	2.70	2.2	1.7	1.4	0.9	0.4	0.1
VTP*											
VTP110F	2.0	1.7	1.4	1.12	1.10	0.85	0.75	0.7	0.4	0.2	0.1
VTP170F	3.2	2.7	2.2	1.80	1.70	1.3	1.0	0.8	0.5	0.3	0.1
VTP170SSF	3.2	2.7	2.2	1.80	1.70	1.3	1.0	0.8	0.5	0.3	0.1
VTP170XF	3.2	2.7	2.2	1.80	1.70	1.3	1.0	0.8	0.5	0.3	0.1
VTP170XSF	3.2	2.7	2.2	1.80	1.70	1.3	1.0	0.8	0.5	0.3	0.1
VTP175F	3.2	2.7	2.2	1.84	1.75	1.3	1.0	0.8	0.5	0.3	0.1
VTP175LF	3.2	2.7	2.2	1.84	1.75	1.3	1.0	0.8	0.5	0.3	0.1
VTP210GF	4.1	3.5	2.9	2.26	2.10	1.6	1.3	1.0	0.7	0.4	0.1
VTP210SF	4.1	3.5	2.9	2.26	2.10	1.6	1.3	1.0	0.7	0.4	0.1
120°C Typical Activation											
MXP*											
MXP190BB	—	—	2.6	—	1.90	—	—	0.85	—	—	—
MXP370BD	—	—	5.0	—	3.70	—	—	1.90	—	—	—
125°C Typical Activation											
SRP											
SRP120F	1.9	1.7	1.5	1.20	1.17	1.0	0.9	0.8	0.6	0.5	0.4
SRP120LF	1.9	1.7	1.5	1.20	1.17	1.0	0.9	0.8	0.6	0.5	0.4
SRP120SF	1.9	1.7	1.5	1.20	1.17	1.0	0.9	0.8	0.6	0.5	0.4
SRP175F	2.5	2.2	2.0	1.75	1.68	1.4	1.3	1.2	1.0	0.9	0.8
SRP175LF	2.5	2.2	2.0	1.75	1.68	1.4	1.3	1.2	1.0	0.9	0.8
SRP175SF	2.5	2.2	2.0	1.75	1.68	1.4	1.3	1.2	1.0	0.9	0.8
SRP200F	3.1	2.8	2.5	2.00	1.97	1.7	1.5	1.4	1.2	1.0	0.9
SRP350F	5.3	4.8	4.3	3.50	3.44	3.0	2.7	2.5	2.1	1.8	1.7
SRP420F	6.3	5.7	5.1	4.20	4.11	3.6	3.3	3.0	2.6	2.2	2.1
LR4											
LR4-190F	2.8	2.5	2.3	1.9	1.86	1.6	1.5	1.4	1.2	1.1	1.0
LR4-260F	3.8	3.4	3.1	2.6	2.54	2.2	2.0	1.9	1.7	1.4	1.3
LR4-260SF	3.8	3.4	3.1	2.6	2.54	2.2	2.0	1.9	1.7	1.4	1.3
LR4-380F	5.4	4.9	4.4	3.8	3.64	3.3	3.0	2.8	2.5	2.3	2.1
LR4-380XF	5.4	4.9	4.4	3.8	3.64	3.3	3.0	2.8	2.5	2.3	2.1
LR4-450F	6.5	5.8	5.3	4.5	4.38	3.9	3.6	3.3	2.9	2.6	2.4
LR4-550F	7.6	6.9	6.2	5.5	5.32	4.7	4.3	4.0	3.6	3.2	3.0
LR4-600F	8.7	7.8	7.1	6.0	5.86	5.2	4.7	4.4	3.9	3.4	3.2
LR4-600XF	8.7	7.8	7.1	6.0	5.86	5.2	4.7	4.4	3.9	3.4	3.2
LR4-730F	10.5	9.5	8.6	7.3	7.13	6.3	5.7	5.4	4.7	4.2	4.0
LR4-900F	12.7	11.4	10.0	9.0	8.50	7.5	6.8	6.2	5.5	4.9	4.5
LR4-1300SSF	17.9	16.2	14.5	13.0	12.40	11.1	10.3	9.5	8.6	7.7	7.2

* Product electrical characteristics determined at 25°C.

Figure B1 Thermal Derating Curve for Strap Battery Devices

- A = LR4
- B = SRP
- C = VTP, VLP, MXP
- D = VLR

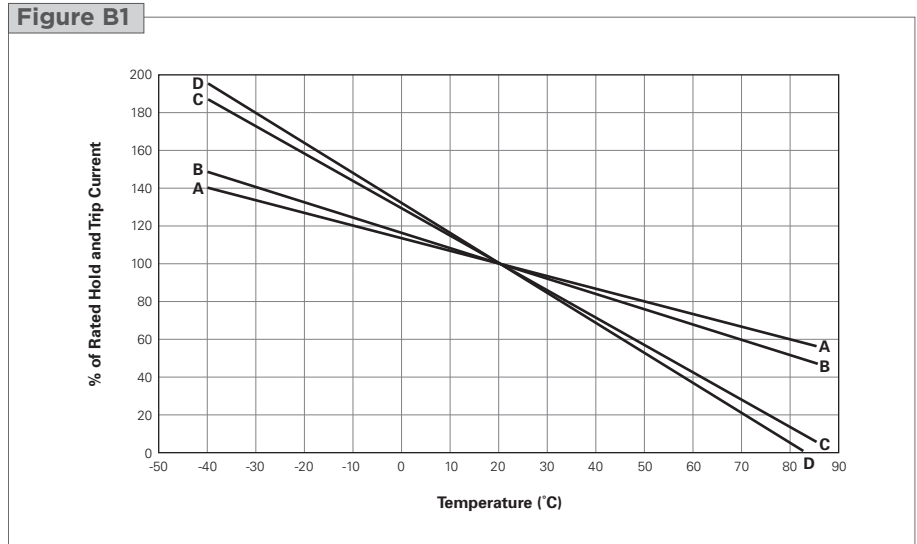

Table B3 Electrical Characteristics for Strap Battery Devices

Part Number	I _H (A)	I _T (A)	V _{MAX} (V _{DC})	I _{MAX} (A)	P _{D MAX} (W)	Max. Time-to-trip		R _{MIN} (Ω)	R _{MAX} (Ω)	R _{1MAX} (Ω)	Figure for Dimensions
						(A)	(s)				
85°C Typical Activation											
VLR*											
VLR170F	1.70	4.1	12	100	1.4	8.50	5.0	0.018	0.032	0.064	B3
VLR170LF	1.70	4.1	12	100	1.4	8.50	5.0	0.018	0.032	0.064	B3
VLR170UF	1.70	4.1	12	100	1.4	8.50	5.0	0.018	0.032	0.064	B5
VLR175F	1.75	4.2	12	100	1.4	8.75	5.0	0.017	0.031	0.062	B3
VLR175LF	1.75	4.2	12	100	1.4	8.75	5.0	0.017	0.031	0.062	B3
VLR175UF	1.75	4.2	12	100	1.4	8.75	5.0	0.017	0.031	0.062	B5
VLR230F	2.30	5.0	12	100	2.5	10.00	5.0	0.012	0.018	0.036	B3
90°C Typical Activation											
VLP*											
VLP120UF	1.20	3.6	16	60	1.6	7.00	5.0	0.039	0.067	0.134	B5
VLP175UF	1.75	3.9	16	60	1.6	8.75	5.0	0.030	0.050	0.100	B5
VLP210F	2.10	5.0	16	60	1.8	10.50	5.0	0.018	0.030	0.060	B2
VLP220F	2.20	5.3	16	60	1.8	11.00	5.0	0.017	0.029	0.058	B3
VLP270F	2.70	6.5	16	60	2.5	13.50	5.0	0.012	0.018	0.036	B3
VTP*											
VTP110F	1.10	2.7	16	100	1.3	5.50	5.0	0.038	0.070	0.140	B5
VTP170F	1.70	3.4	16	100	1.4	8.50	5.0	0.030	0.052	0.105	B2
VTP170SSF	1.70	3.4	16	100	1.4	8.50	5.0	0.030	0.052	0.105	B7
VTP170XF	1.70	3.4	16	100	1.4	8.50	5.0	0.030	0.052	0.105	B3
VTP170XSF	1.70	3.4	16	100	1.4	8.50	5.0	0.030	0.052	0.105	B4
VTP175F	1.75	3.6	16	100	1.4	8.75	5.0	0.029	0.051	0.102	B3
VTP175LF	1.75	3.6	16	100	1.4	8.75	5.0	0.029	0.051	0.102	B3
VTP210GF	2.10	4.7	16	100	1.5	10.00	5.0	0.018	0.030	0.060	B3
VTP210SF	2.10	4.7	16	100	1.5	10.00	5.0	0.018	0.030	0.060	B4
120°C Typical Activation											
MXP*											
MXP190BB	1.90	4.9	6	50	1.0	9.50	2.0	0.007	0.015	0.024	B12
MXP370BD	3.70	9.0	6	50	1.3	18.50	5.0	0.004	0.010	0.016	B12

* Product electrical characteristics determined at 25°C.

Table B3 Electrical Characteristics for Strap Battery Devices

Cont'd

Part Number	I_H (A)	I_T (A)	V_{MAX} (V _{DC})	I_{MAX} (A)	$P_{D MAX}$ (W)	Max. Time-to-trip (A)	(s)	R_{MIN} (Ω)	R_{MAX} (Ω)	R_{1MAX} (Ω)	Figure for Dimensions
125°C Typical Activation SRP											
SRP120F	1.20	2.7	15	100	1.2	6.00	5.0	0.085	0.160	0.220	B6
SRP120LF	1.20	2.7	15	100	1.2	6.00	5.0	0.085	0.160	0.220	B6
SRP120SF	1.20	2.7	15	100	1.2	6.00	5.0	0.085	0.160	0.220	B10
SRP175F	1.75	3.8	15	100	1.5	8.75	5.0	0.050	0.090	0.120	B6
SRP175LF	1.75	3.8	15	100	1.5	8.75	5.0	0.050	0.090	0.120	B6
SRP175SF	1.75	3.8	15	100	1.5	8.75	5.0	0.050	0.090	0.120	B10
SRP200F	2.00	4.4	30	100	1.9	10.00	4.0	0.030	0.060	0.100	B6
SRP350F	3.50	6.3	30	100	2.5	20.00	3.0	0.017	0.031	0.050	B6
SRP420F	4.20	7.6	30	100	2.9	20.00	6.0	0.012	0.024	0.040	B6
LR4											
LR4-190F	1.90	3.9	15	100	1.2	9.5	5.0	0.0390	0.0720	0.102	B8
LR4-260F	2.60	5.8	15	100	2.5	13.0	5.0	0.0200	0.0420	0.063	B8
LR4-260SF	2.60	5.8	15	100	2.5	13.0	5.0	0.0200	0.0420	0.063	B9
LR4-380F	3.80	8.3	15	100	2.5	19.0	5.0	0.0130	0.0260	0.037	B8
LR4-380XF	3.80	8.3	15	100	2.5	19.0	5.0	0.0130	0.0260	0.037	B8
LR4-450F	4.50	8.9	20	100	2.3	22.5	5.0	0.0110	0.0200	0.028	B8
LR4-550F	5.50	10.5	20	100	2.8	27.5	5.0	0.0090	0.0160	0.022	B8
LR4-600F	6.00	11.7	20	100	2.8	30.0	5.0	0.0070	0.0140	0.019	B8
LR4-600XF	6.00	11.7	20	100	2.8	30.0	5.0	0.0075	0.0140	0.019	B8
LR4-730F	7.30	14.1	20	100	3.3	30.0	5.0	0.0060	0.0120	0.015	B8
LR4-900F	9.00	16.7	20	100	3.8	45.0	5.0	0.0060	0.0100	0.014	B8
LR4-1300SSF	13.00	21.2	20	100	4.5	50.0	10.0	0.0035	0.0065	0.009	B11

* Product electrical characteristics determined at 25°C.

Notes:

- I_H : Hold current: maximum current device will pass without interruption in 20°C still air unless otherwise specified.
- I_T : Trip current: minimum current that will switch the device from low resistance to high resistance in 20°C still air unless otherwise specified.
- V_{MAX} : Maximum voltage device can withstand without damage at rated current.
- I_{MAX} : Maximum fault current device can withstand without damage at rated voltage.
- P_D : Power dissipated from device when in the tripped state in 20°C still air unless otherwise specified.
- R_{MIN} : Minimum resistance of device as supplied at 20°C unless otherwise specified.
- R_{MAX} : Maximum resistance of device as supplied at 20°C unless otherwise specified.
- R_{1MAX} : Maximum resistance, measured at 20°C unless otherwise specified, of device one hour after being tripped the first time.

Figure B2-B12 Dimension Figures for Strap Battery Devices

Figure B5

Figure B6

Figure B7

Figure B8

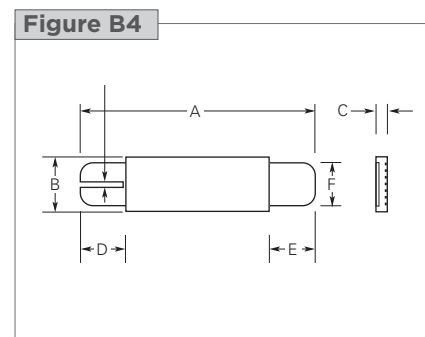
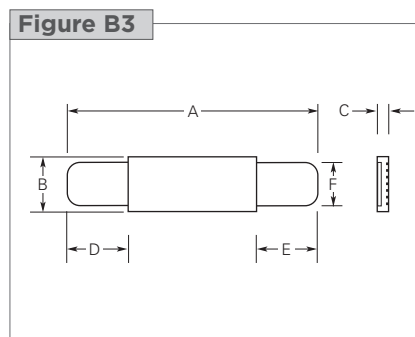
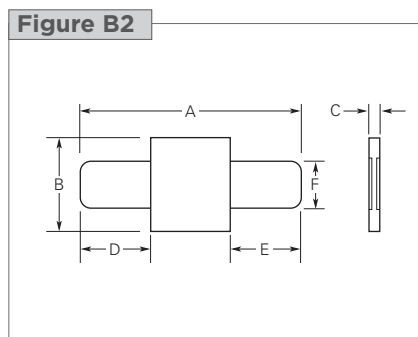
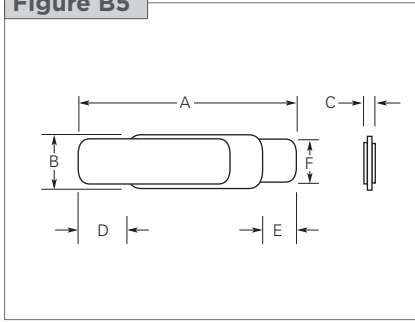
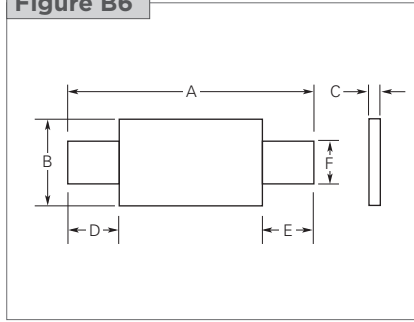
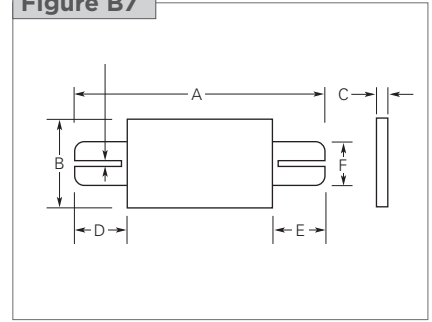
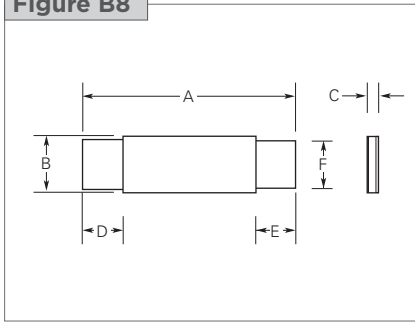
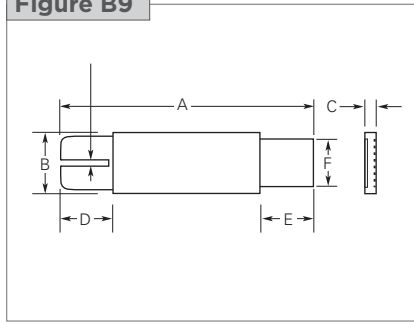
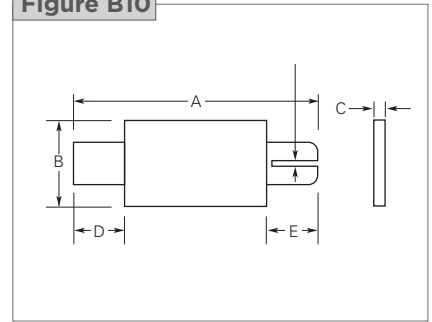
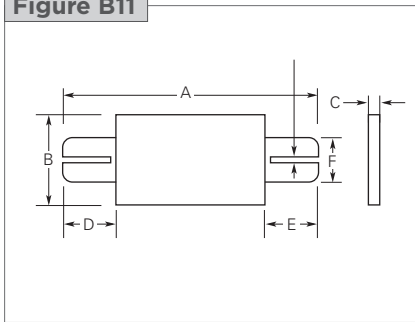
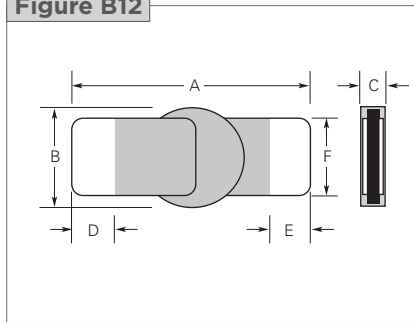
Figure B9

Figure B10

Figure B11

Figure B12

Table B4 Dimensions for Strap Battery Devices in Millimeters (Inches)

Part Number	A		B		C		D		E		F		Figure
	Min.	Max.	Min.	Max.	Min.	Max.	Min.	Max.	Min.	Max.	Min.	Max.	
85°C Typical Activation													
VLR													
VLR170F	20.8 (0.832)	23.2 (0.928)	3.5 (0.140)	3.9 (0.156)	—	0.8 (0.032)	4.5 (0.180)	6.5 (0.260)	4.5 (0.180)	6.5 (0.260)	2.4 (0.096)	2.6 (0.104)	B3
VLR170LF	38.8 (1.552)	41.2 (1.648)	3.5 (0.140)	3.9 (0.156)	—	0.8 (0.032)	8.7 (0.348)	10.3 (0.412)	18.7 (0.748)	20.3 (0.812)	2.4 (0.096)	2.6 (0.104)	B3
VLR170UF	20.8 (0.832)	23.2 (0.928)	3.5 (0.140)	3.7 (0.148)	—	0.07 (0.003)	5.3 (0.212)	6.7 (0.268)	5.3 (0.212)	6.7 (0.268)	2.4 (0.096)	2.6 (0.104)	B5
VLR175F	23.0 (0.920)	24.5 (0.980)	2.9 (0.116)	3.3 (0.132)	0.5 (0.020)	0.8 (0.032)	4.7 (0.188)	7.2 (0.288)	3.8 (0.152)	5.4 (0.216)	2.4 (0.096)	2.6 (0.104)	B3
VLR175LF	29.3 (1.172)	31.7 (1.268)	2.9 (0.116)	3.3 (0.132)	—	0.8 (0.032)	5.2 (0.208)	6.8 (0.272)	10 (0.400)	12.5 (0.500)	2.4 (0.096)	2.6 (0.104)	B3
VLR175UF	23.0 (0.920)	24.5 (0.980)	2.9 (0.116)	3.1 (0.124)	—	0.7 (0.028)	5.2 (0.208)	7.5 (0.300)	4.3 (0.172)	5.7 (0.228)	2.4 (0.096)	2.6 (0.104)	B5
VLR230F	20.9 (0.836)	23.1 (0.924)	4.9 (0.196)	5.3 (0.212)	—	0.8 (0.032)	4.1 (0.164)	5.8 (0.232)	4.1 (0.164)	5.8 (0.232)	3.9 (0.156)	4.1 (0.164)	B3

Table B4 Dimensions for Strap Battery Devices in Millimeters (Inches)

Cont'd

Part Number	A		B		C		D		E		F		Figure
	Min.	Max.	Min.	Max.	Min.	Max.	Min.	Max.	Min.	Max.	Min.	Max.	
90°C Typical Activation													
VLP													
VLP120UF	10.9 (0.430)	11.8 (0.460)	4.4 (0.170)	4.6 (0.180)	— (0.028)	0.7 (0.028)	5.5 (0.220)	6.5 (0.260)	1.65 (0.065)	1.9 (0.075)	2.3 (0.091)	2.5 (0.098)	B5
VLP175UF	19.0 (0.750)	21.0 (0.830)	3.4 (0.130)	3.6 (0.140)	— (0.030)	0.7 (0.030)	10.0 (0.390)	11.0 (0.430)	2.5 (0.100)	3.5 (0.140)	2.9 (0.110)	3.1 (0.120)	B5
VLP210F	15.4 (0.616)	17.5 (0.700)	6.9 (0.276)	7.3 (0.292)	0.6 (0.024)	0.8 (0.032)	4.0 (0.160)	6.2 (0.248)	4.0 (0.160)	6.2 (0.248)	3.9 (0.156)	4.1 (0.164)	B2
VLP220F	21.1 (0.844)	23.3 (0.932)	3.5 (0.140)	3.9 (0.156)	0.6 (0.024)	0.8 (0.032)	5.1 (0.204)	6.8 (0.272)	5.1 (0.204)	6.8 (0.272)	2.9 (0.116)	3.1 (0.124)	B3
VLP270F	20.9 (0.836)	23.1 (0.924)	4.9 (0.196)	5.3 (0.212)	0.6 (0.024)	0.8 (0.032)	4.1 (0.164)	5.8 (0.232)	4.1 (0.164)	5.8 (0.232)	3.9 (0.156)	4.1 (0.164)	B3
VTP													
VTP110F	23.6 (0.944)	25.6 (1.024)	2.7 (0.108)	2.9 (0.116)	— (0.028)	0.7 (0.028)	7.0 (0.280)	8.0 (0.320)	7.0 (0.280)	8.0 (0.320)	2.3 (0.092)	2.5 (0.100)	B5
VTP170F	15.4 (0.616)	17.5 (0.700)	7.0 (0.280)	7.4 (0.296)	0.5 (0.020)	0.8 (0.032)	4.0 (0.160)	6.2 (0.248)	4.0 (0.160)	6.2 (0.248)	3.9 (0.156)	4.1 (0.164)	B2
VTP170SSF	15.4 (0.616)	17.5 (0.700)	7.0 (0.280)	7.4 (0.296)	0.5 (0.020)	0.8 (0.032)	4.0 (0.160)	6.2 (0.248)	4.0 (0.160)	6.2 (0.248)	3.9 (0.156)	4.1 (0.164)	B7
VTP170XF	20.9 (0.836)	22.9 (0.916)	4.9 (0.196)	5.3 (0.212)	0.5 (0.020)	0.8 (0.032)	6.0 (0.240)	8.6 (0.344)	6.0 (0.240)	8.6 (0.344)	3.9 (0.156)	4.1 (0.164)	B3
VTP170XSF	20.9 (0.836)	22.9 (0.916)	4.9 (0.196)	5.3 (0.212)	0.5 (0.020)	0.8 (0.032)	6.0 (0.240)	8.6 (0.344)	6.0 (0.240)	8.6 (0.344)	3.9 (0.156)	4.1 (0.164)	B4
VTP175F	21.2 (0.848)	23.2 (0.928)	3.5 (0.140)	3.9 (0.156)	— (0.032)	0.8 (0.032)	4.6 (0.184)	6.6 (0.264)	4.6 (0.184)	6.6 (0.264)	2.9 (0.116)	3.1 (0.124)	B3
VTP175LF	25.8 (1.032)	28.2 (1.128)	3.5 (0.140)	3.9 (0.156)	— (0.032)	0.8 (0.032)	5.7 (0.228)	7.3 (0.292)	8.7 (0.348)	10.3 (0.412)	2.4 (0.096)	2.6 (0.104)	B3
VTP210GF	20.9 (0.836)	23.1 (0.924)	4.9 (0.196)	5.3 (0.212)	— (0.032)	0.8 (0.032)	4.1 (0.164)	5.8 (0.232)	4.1 (0.164)	5.8 (0.232)	3.9 (0.156)	4.1 (0.164)	B3
VTP210SF	20.9 (0.836)	23.1 (0.924)	4.9 (0.196)	5.3 (0.212)	0.6 (0.024)	0.8 (0.032)	4.1 (0.164)	5.8 (0.232)	4.1 (0.164)	5.8 (0.232)	3.9 (0.156)	4.1 (0.164)	B4
120°C Typical Activation													
MXP													
MXP190BB	9.2 (0.368)	10.8 (0.432)	2.96 (0.118)	3.26 (0.130)	0.7 (0.028)	1.1 (0.044)	1.6 (0.064)	3.1 (0.124)	1.6 (0.064)	3.1 (0.124)	2.2 (0.088)	2.4 (0.096)	B12
MXP370BD	10.5 (0.420)	11.3 (0.452)	2.96 (0.118)	3.26 (0.130)	0.7 (0.028)	1.1 (0.044)	5.0 (0.200)	—	2.0 (0.080)	—	2.2 (0.088)	2.4 (0.096)	B12
125°C Typical Activation													
SRP													
SRP120F	19.9 (0.796)	22.1 (0.884)	4.9 (0.196)	5.2 (0.208)	0.6 (0.024)	1.0 (0.040)	5.5 (0.220)	7.5 (0.300)	5.5 (0.220)	7.5 (0.300)	3.9 (0.156)	4.1 (0.164)	B6
SRP120LF	24.9 (0.996)	27.1 (1.084)	4.9 (0.196)	5.2 (0.208)	0.6 (0.024)	1.0 (0.040)	5.5 (0.220)	7.5 (0.300)	10.5 (0.420)	12.5 (0.500)	3.9 (0.156)	4.1 (0.164)	B6
SRP120SF	19.9 (0.796)	22.1 (0.884)	4.9 (0.196)	5.2 (0.208)	0.6 (0.024)	1.0 (0.040)	5.5 (0.220)	7.5 (0.300)	5.5 (0.220)	7.5 (0.300)	3.9 (0.156)	4.1 (0.164)	B10
SRP175F	20.9 (0.836)	23.1 (0.924)	4.9 (0.196)	5.2 (0.208)	0.6 (0.024)	1.0 (0.040)	4.1 (0.164)	5.5 (0.220)	4.1 (0.164)	5.5 (0.220)	3.9 (0.156)	4.1 (0.164)	B6
SRP175LF	29.9 (1.196)	32.1 (1.284)	4.9 (0.196)	5.2 (0.208)	0.6 (0.024)	1.0 (0.040)	10.5 (0.420)	12.5 (0.500)	5.5 (0.220)	7.5 (0.300)	3.9 (0.156)	4.1 (0.164)	B6
SRP175SF	20.9 (0.836)	23.1 (0.924)	4.9 (0.196)	5.2 (0.208)	0.6 (0.024)	1.0 (0.040)	4.1 (0.164)	5.5 (0.220)	4.1 (0.164)	5.5 (0.220)	3.9 (0.156)	4.1 (0.164)	B10
SRP200F	21.3 (0.852)	23.4 (0.936)	10.2 (0.408)	11.0 (0.440)	0.5 (0.020)	1.1 (0.044)	5.0 (0.200)	7.6 (0.304)	5.0 (0.200)	7.6 (0.304)	4.8 (0.192)	5.4 (0.216)	B6
SRP350F	28.4 (1.136)	31.8 (1.272)	13.0 (0.520)	13.5 (0.540)	0.5 (0.020)	1.1 (0.044)	6.3 (0.252)	8.9 (0.356)	6.3 (0.252)	8.9 (0.356)	6.0 (0.240)	6.6 (0.264)	B6
SRP420F	30.6 (1.224)	32.4 (1.296)	12.9 (0.516)	13.6 (0.544)	0.5 (0.020)	1.1 (0.044)	5.0 (0.200)	7.5 (0.300)	5.0 (0.200)	7.5 (0.300)	6.0 (0.240)	6.7 (0.268)	B6

Table B4 Dimensions for Strap Battery Devices in Millimeters (Inches)

Cont'd

Part Number	A		B		C		D		E		F		Figure
	Min.	Max.	Min.	Max.	Min.	Max.	Min.	Max.	Min.	Max.	Min.	Max.	
LR4													
LR4-190F	19.9 (0.796)	22.1 (0.884)	4.9 (0.196)	5.5 (0.220)	0.6 (0.024)	1.0 (0.040)	5.5 (0.220)	7.5 (0.300)	5.5 (0.220)	7.5 (0.300)	3.9 (0.156)	4.1 (0.164)	B8
LR4-260F	20.9 (0.836)	23.1 (0.924)	4.9 (0.196)	5.5 (0.220)	0.6 (0.024)	1.0 (0.040)	4.1 (0.164)	5.5 (0.220)	4.1 (0.164)	5.5 (0.220)	3.9 (0.156)	4.1 (0.164)	B8
LR4-260SF	20.9 (0.836)	23.1 (0.924)	4.9 (0.196)	5.5 (0.220)	0.6 (0.024)	1.0 (0.040)	4.1 (0.164)	5.5 (0.220)	4.1 (0.164)	5.5 (0.220)	3.9 (0.156)	4.1 (0.164)	B9
LR4-380F	24.0 (0.960)	26.0 (1.040)	6.9 (0.276)	7.5 (0.300)	0.6 (0.024)	1.0 (0.040)	4.1 (0.164)	5.5 (0.220)	4.1 (0.164)	5.5 (0.220)	4.9 (0.196)	5.1 (0.204)	B8
LR4-380XF	32.2 (1.288)	35.8 (1.432)	4.9 (0.196)	5.5 (0.220)	0.6 (0.024)	1.0 (0.040)	5.5 (0.220)	7.5 (0.300)	5.5 (0.220)	7.5 (0.300)	3.9 (0.156)	4.1 (0.164)	B8
LR4-450F	24.0 (0.960)	26 (1.040)	9.9 (0.396)	10.5 (0.420)	0.6 (0.024)	1.0 (0.040)	5.3 (0.212)	6.7 (0.268)	5.3 (0.212)	6.7 (0.268)	5.9 (0.236)	6.1 (0.244)	B8
LR4-550F	35.0 (1.400)	37.0 (1.480)	6.9 (0.276)	7.5 (0.300)	0.6 (0.024)	1.0 (0.040)	5.3 (0.212)	6.7 (0.268)	5.3 (0.212)	6.7 (0.268)	4.9 (0.196)	5.1 (0.204)	B8
LR4-600F	24.0 (0.960)	26.0 (1.040)	13.9 (0.556)	14.5 (0.580)	0.6 (0.024)	1.0 (0.040)	4.1 (0.164)	5.5 (0.220)	4.1 (0.164)	5.5 (0.220)	5.9 (0.236)	6.1 (0.244)	B8
LR4-600XF	40.5 (1.620)	42.7 (1.708)	6.9 (0.276)	7.5 (0.300)	0.6 (0.024)	1.0 (0.040)	5.2 (0.208)	6.8 (0.272)	5.2 (0.208)	6.8 (0.272)	4.9 (0.196)	5.1 (0.204)	B8
LR4-730F	27.1 (1.084)	29.1 (1.164)	13.9 (0.556)	14.5 (0.580)	0.6 (0.024)	1.0 (0.040)	4.1 (0.164)	5.5 (0.220)	4.1 (0.164)	5.5 (0.220)	5.9 (0.236)	6.1 (0.244)	B8
LR4-900F	45.4 (1.816)	47.6 (1.904)	7.9 (0.316)	8.5 (0.340)	0.9 (0.036)	1.3 (0.052)	4.6 (0.184)	6.2 (0.248)	4.6 (0.184)	6.2 (0.248)	5.9 (0.236)	6.1 (0.244)	B8
LR4-1300SSF	61.5 (2.460)	66.5 (2.660)	9.4 (0.376)	10.0 (0.400)	0.9 (0.036)	1.3 (0.052)	5.0 (0.200)	7.5 (0.300)	5.0 (0.200)	7.5 (0.300)	5.9 (0.236)	6.1 (0.244)	B11

Figure B13-B18 Typical Time-to-trip Curves at 20°C for Strap Battery Devices
VLR (data at 25°C)

A = VLR170F

B = VLR175F

C = VLR230F

Figure B13

Figure B13-B18 Typical Time-to-trip Curves at 20°C for Strap Battery Devices

Cont'd

VLP (data at 25°C)

- A = VLP120UF
- B = VLP175UF
- C = VLP210F
- D = VLP220F
- E = VLP270F

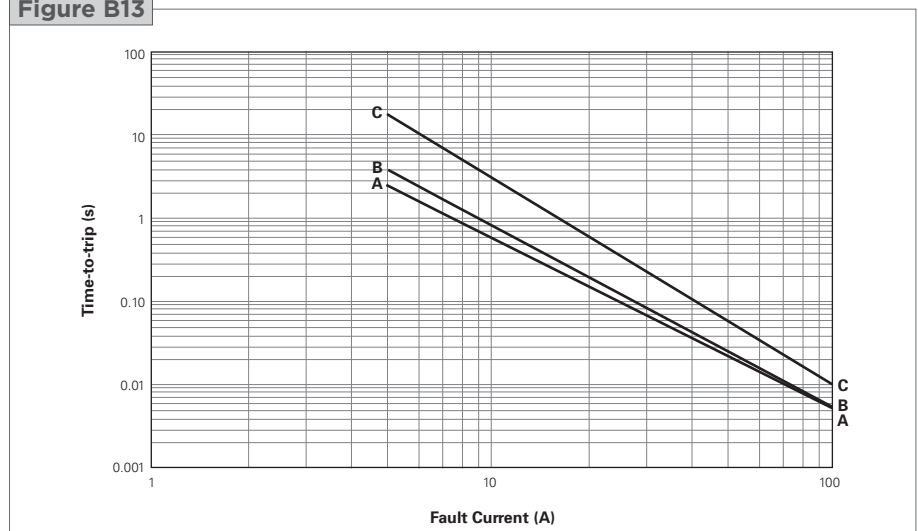
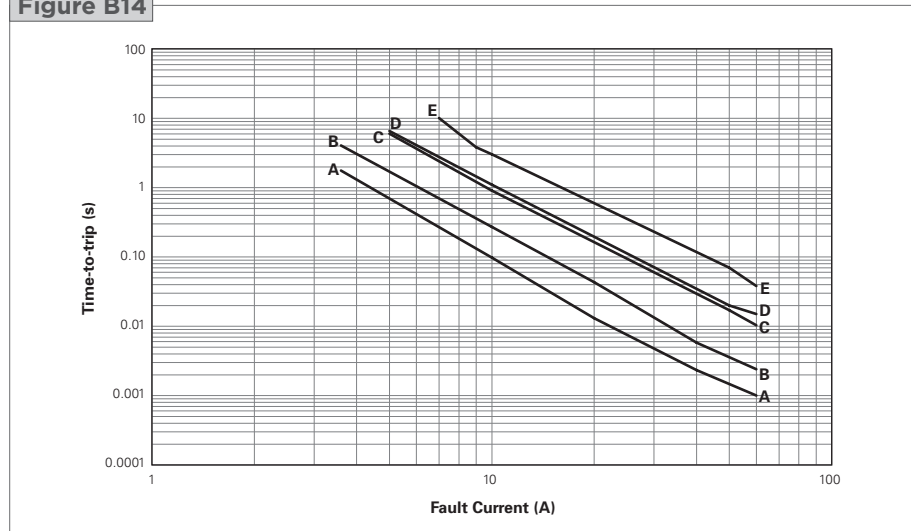
Figure B14

VTP (data at 25°C)

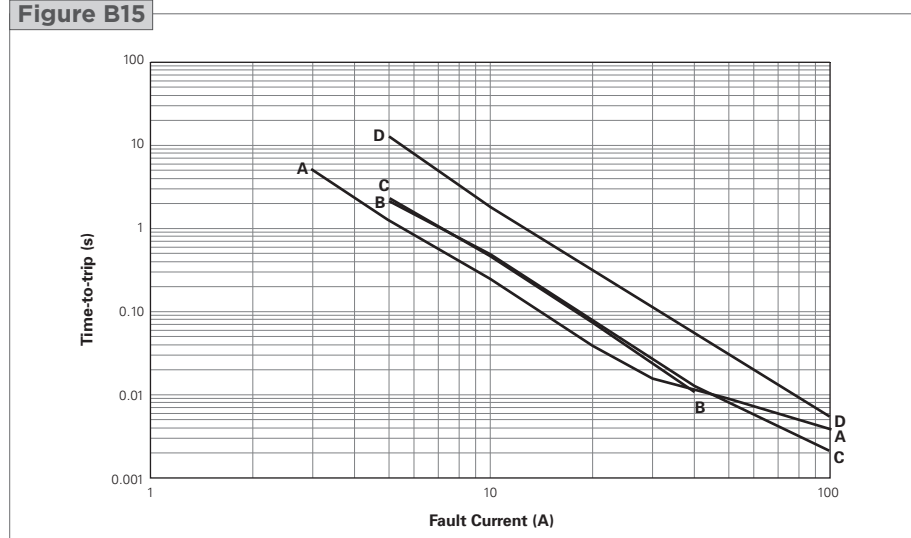
- A = VTP110F
- B = VTP170F
- C = VTP175F
- D = VTP210GF

Figure B15

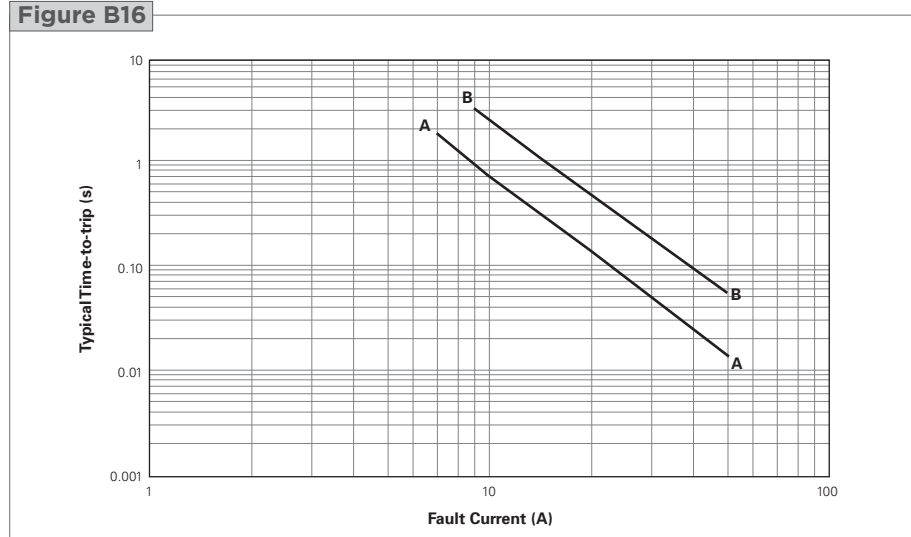
MXP (data at 25°C)

- A = MXP190BB
- B = MXP370BD

Figure B16

SRP

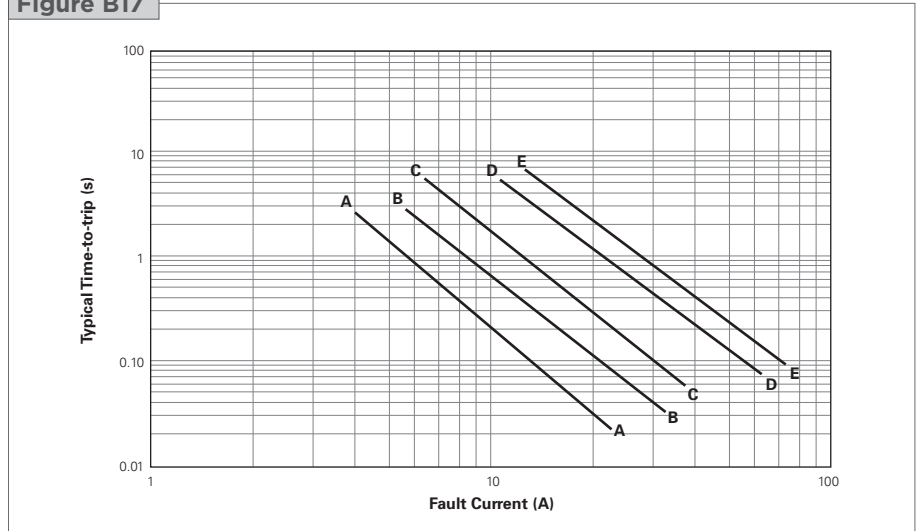
- A = SRP120F
- B = SRP175F
- C = SRP200F
- D = SRP350F
- E = SRP420F

Figure B17

LR4

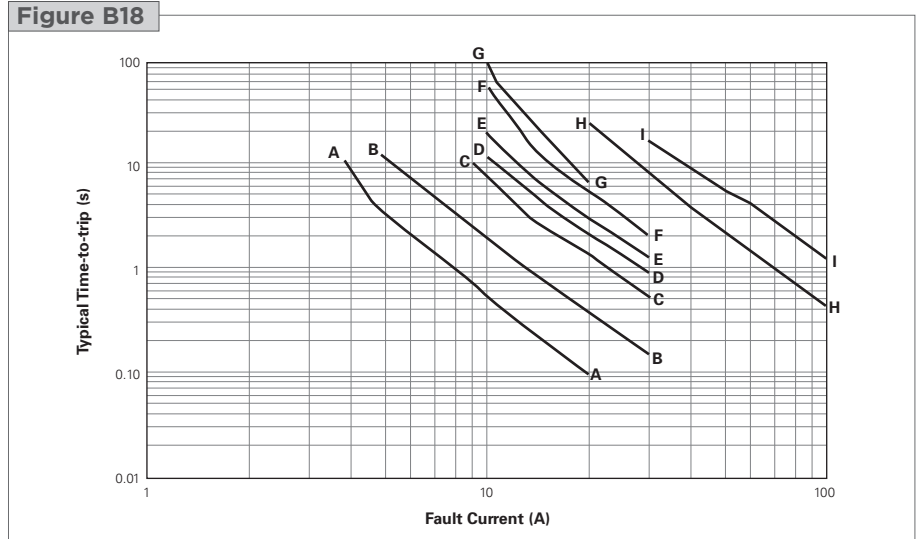
- A = LR4-190F
- B = LR4-260F
- C = LR4-380F
- D = LR4-450F
- E = LR4-550F
- F = LR4-600F
- G = LR4-730F
- H = LR4-900F
- I = LR4-1300SSF

Figure B18

Table B5 Physical Characteristics and Environmental Specifications for Strap Battery Devices
VLR
Physical Characteristics

Lead material	0.125mm nominal thickness, quarter-hard nickel
Tape material	Polyester

Environmental Specifications

Test	Conditions	Resistance Change
Passive aging	-40°C, 1000 hours	±5% typical
	60°C, 1000 hours	±20% typical
Humidity aging	60°C/95% RH, 1000 hours	±30% typical
Thermal shock	85°C, -40°C (10 times)	±5% typical
Vibration	MIL-STD-883D, Method 2026	No change

Table B5 Physical Characteristics and Environmental Specifications for Strap Battery Devices

Cont'd

VLP and VTP
Physical Characteristics

Lead material	0.125mm nominal thickness, quarter-hard nickel
Tape material	Polyester

Environmental Specifications

Test	Conditions	Resistance Change
Passive aging	-40°C, 1000 hours	±5% typical
	60°C, 1000 hours	±10% typical
Humidity aging	60°C/95% RH, 1000 hours	±10% typical
Thermal shock	85°C, -40°C (10 times)	±5% typical
Vibration	MIL-STD-883D, Method 2026	No change

MXP
Physical Characteristics

Lead material	0.1mm nominal thickness, half-hard nickel
Coating material	Epoxy

Environmental Specifications

Test	Conditions	Resistance Change
Passive aging	-40°C, 1000 hours	±5% typical
	60°C, 1000 hours	±20% typical
Humidity aging	60°C/95% RH, 1000 hours	±30% typical
Thermal shock	85°C, -40°C (10 times)	±5% typical
Vibration	MIL-STD-883D, Method 2026	No change

SRP
Physical Characteristics

Lead material	0.125mm nominal thickness, quarter-hard nickel
Tape material	Polyester

Environmental Specifications

Test	Conditions	Resistance Change
Passive aging	70°C, 1000 hours	±10% typical
Humidity aging	85°C/85% RH, 7 days	±5% typical
Vibration	MIL-STD-883C, Test Condition A	No change

LR4
Physical Characteristics

Lead material	0.125mm nominal thickness, quarter-hard nickel
Tape material	Polyester

Environmental Specifications

Test	Conditions	Resistance Change
Passive aging	70°C, 1000 hours	±10% typical
Humidity aging	85°C/85% RH, 7 days	±5% typical
Vibration	MIL-STD-883D, Method 2026	No change

Note: Storage conditions: 40°C max., 70% RH max.; devices should remain in original sealed bags prior to use. Devices may not meet specified values if these storage conditions are exceeded.

Table B6 Packaging and Marking Information/Agency Recognition for Strap Battery Devices

Part Number	Bag Quantity	Tape & Reel Quantity	Standard Package Quantity	Part Marking	Agency Recognition
85°C Typical Activation					
VLR					
VLR170F	1,000	—	10,000	R17	UL, CSA, TÜV
VLR170LF	1,000	—	10,000	R17	UL, CSA, TÜV
VLR170UF	1,000	—	10,000	—	UL, CSA, TÜV
VLR175F	1,000	—	10,000	R1X	UL, CSA, TÜV
VLR175LF	1,000	—	10,000	R1X	UL, CSA, TÜV
VLR175UF	1,000	—	10,000	—	UL, CSA, TÜV
VLR230F	1,000	—	10,000	R23	UL, CSA, TÜV
90°C Typical Activation					
VLP					
VLP120UF	1,000	—	10,000	—	UL, CSA, TÜV
VLP175UF	1,000	—	10,000	—	UL, CSA, TÜV
VLP210F	1,000	—	10,000	W21	UL, CSA, TÜV
VLP220F	1,000	—	10,000	W22	UL, CSA, TÜV
VLP270F	1,000	—	10,000	W27	UL, CSA, TÜV
VTP					
VTP110F	1,000	—	10,000	—	UL, CSA, TÜV
VTP170F	1,000	—	10,000	V17	UL, CSA, TÜV
VTP170SSF	1,000	—	10,000	V17	UL, CSA, TÜV
VTP170XF	1,000	—	10,000	V17	UL, CSA, TÜV
VTP170XSf	1,000	—	10,000	V17	UL, CSA, TÜV
VTP175F	1,000	—	10,000	V1X	UL, CSA, TÜV
VTP175LF	1,000	—	10,000	V1X	UL, CSA, TÜV
VTP210GF	1,000	—	10,000	V21	UL, CSA, TÜV
VTP210SF	1,000	—	10,000	V21	UL, CSA, TÜV
120°C Typical Activation					
MXP					
MXP190BB	4,000	—	8,000	—	UL, CSA, TÜV
MXP370BD	2,000	—	4,000	—	UL, CSA, TÜV
125°C Typical Activation					
SRP					
SRP120F	1,000	—	10,000	120	UL, CSA, TÜV
SRP120LF	1,000	—	10,000	120	UL, CSA, TÜV
SRP120SF	2,000	—	10,000	120	UL, CSA, TÜV
SRP175F	2,000	—	10,000	175	UL, CSA, TÜV
SRP175LF	1,000	—	10,000	175	UL, CSA, TÜV
SRP175SF	2,000	—	10,000	175	UL, CSA, TÜV
SRP200F	1,000	—	10,000	200	UL, CSA, TÜV
SRP350F	500	—	10,000	350	UL, CSA, TÜV
SRP420F	500	—	10,000	420	UL, CSA, TÜV
LR4					
LR4-190F	2,000	—	10,000	E19	UL, CSA, TÜV
LR4-260F	1,000	—	10,000	E26	UL, CSA, TÜV
LR4-260SF	1,000	—	10,000	E26	UL, CSA, TÜV
LR4-380F	1,000	—	10,000	E38	UL, CSA, TÜV
LR4-380XF	1,000	—	10,000	E38	UL, CSA, TÜV
LR4-450F	1,000	—	10,000	E45	UL, CSA, TÜV
LR4-550F	1,000	—	10,000	E55	UL, CSA, TÜV
LR4-600F	1,000	—	10,000	E60	UL, CSA, TÜV
LR4-600XF	1,000	—	10,000	E60	UL, CSA, TÜV
LR4-730F	1,000	—	10,000	E73	UL, CSA, TÜV
LR4-900F	500	—	10,000	E90	UL, CSA, TÜV
LR4-1300SSF	250	—	10,000	EX3	UL, CSA, TÜV

Agency Recognition for Strap Battery Devices

UL	File # E74889
CSA	File # 78165C
TÜV	Certificate number available on request

Installation Guidelines for the Strap Family

- PPTC devices operate by thermal expansion of the conductive polymer. If devices are placed under pressure or installed in spaces that would prevent thermal expansion, they may not properly protect against damage caused by fault conditions. Designs must be selected in such a manner that adequate space is maintained over the life of the product.
- Twisting, bending, or placing the PPTC device in tension will decrease the ability of the device to protect against damage caused by electrical faults. No residual force should remain on device after installation. Mechanical damage to the PPTC device may affect device performance and should be avoided.
- Chemical contamination of PPTC devices should be avoided. Certain greases, solvents, hydraulic fluids, fuels, industrial cleaning agents, volatile components of adhesives, silicones, and electrolytes can have an adverse effect on device performance.
- PPTC strap devices are designed to be resistance welded to battery cells or to pack interconnect straps, yet some precautions must be taken when doing so. In order for the PPTC device to exhibit its specified performance, weld placement should be a minimum of 2mm from the edge of the PPTC device, weld splatter must not touch the PPTC device, and welding conditions must not heat the PPTC device above its maximum operating temperature.
- PPTC strap devices are not designed for applications where reflow onto flex circuits or rigid circuit boards is required.
- The polyester tape on PPTC strap devices is intended for marking and identification purposes only, not for electrical insulation.
- The coating on MXP devices is intended to prevent oxidization/aging of the devices. Damaging the coating or causing the coating to delaminate can have negative effects on device performance and should be avoided.
- MXP devices have small PPTC chip size and therefore have weaker peel strength between polymer and Ni-foil of the chip. Excessive mechanical force to the device may cause delamination of Ni-foil from polymer.

Part Numbering System for Strap Battery Devices

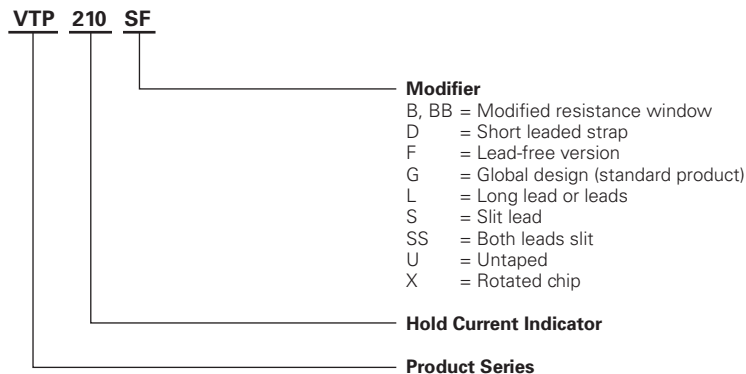

Warning :

- Users should independently evaluate the suitability of and test each product selected for their own application.
- Operation beyond the maximum ratings or improper use may result in device damage and possible electrical arcing and flame.
- These devices are intended for protection against damage caused by occasional overcurrent or overtemperature fault conditions and should not be used when repeated fault conditions or prolonged trip events are anticipated.
- Contamination of the PPTC material with certain silicone-based oils or some aggressive solvents can adversely impact the performance of the devices.
- Device performance can be impacted negatively if devices are handled in a manner inconsistent with recommended electronic, thermal, and mechanical procedures for electronic components.
- PPTC devices are not recommended for installation in applications where the device is constrained such that its PTC properties are inhibited, for example in rigid potting materials or in rigid housings, which lack adequate clearance to accommodate device expansion.
- Operation in circuits with a large inductance can generate a circuit voltage (Ldi/dt) above the rated voltage of the device.

