

### Product Description

Qorvo's QPA1000 is a high-power, S-band amplifier fabricated on Qorvo's QGaN25 0.25 um GaN on SiC production process. Covering 2.8–3.2 GHz, the QPA1000 typically provides 47 dBm of saturated output power and 22 dB of large-signal gain while achieving 58 % power-added efficiency.

The QPA1000 can also support a variety of operating conditions to best support system requirements. With good thermal properties, it can support a range of bias voltages and will perform well under pulse applications. The QPA1000 is matched to 50 ohms with integrated DC blocking caps on both I/O ports. It is ideal for use in both commercial and military radar systems.

Lead-free and RoHS compliant.

Evaluation boards are available upon request.

### Functional Block Diagram

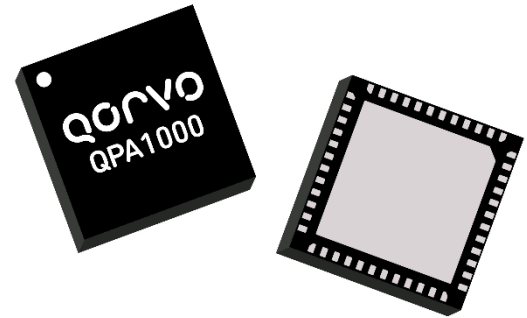
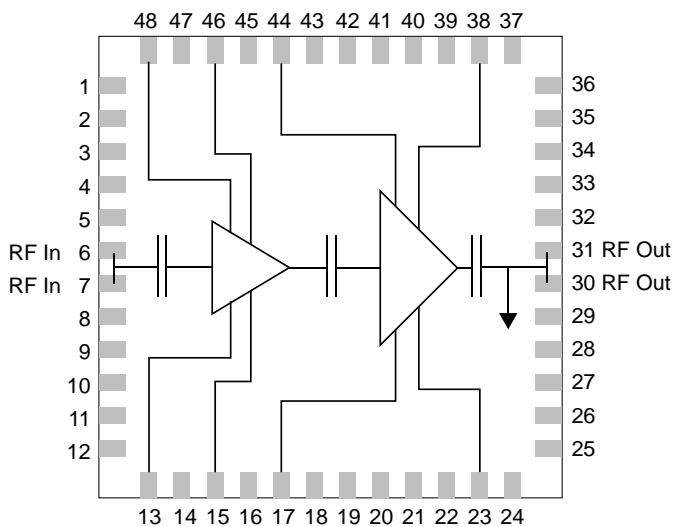

### Product Features

- Frequency Range: 2.8 – 3.2 GHz
- Pout: 47 dBm ( $P_{IN} = 25$  dBm)
- Large Signal Gain: 22 dB ( $P_{IN} = 25$  dBm)
- PAE: 58 % ( $P_{IN} = 25$  dBm)
- Bias:  $V_D = 25$  V,  $I_{DQ} = 200$  mA,  $V_G = -2.8$  V (Typ)
- Supports Long Pulse Operation
- Package Dimensions: 7.0 x 7.0 x 0.85 mm

*Performance is typical across frequency. Please reference electrical specification table and data plots for more details.*

### Applications

- Military Radar
- Commercial Radar

### Ordering Information

Part	Description
QPA1000	2.8–3.2 GHz 50 W GaN Power Amplifier



# QPA1000

## 2.8 – 3.2 GHz 50 Watt GaN Amplifier

### Electrical Specifications

Test conditions, unless otherwise noted: 25 °C,  $V_D = 25$  V,  $I_{DQ} = 200$  mA, Pulse Width = 100 us, Duty Cycle = 10%

Parameter		Min	Typ	Max	Units
Operational Frequency Range		2.8	3.0	3.2	GHz
Output Power @ $P_{IN} = 25$ dBm	Frequency = 3.0 GHz	46	47		dBm
Power Added Efficiency @ $P_{IN} = 25$ dBm	Frequency = 3.0 GHz	50	58		%
Small Signal Gain	Frequency = 3.0 GHz		25		dB
Input Return Loss	Frequency = 3.0 GHz		11		dB
Output Return Loss	Frequency = 3.0 GHz		13		dB
Output Power Temperature Coefficient			-0.004		dBm/°C
Recommended Operating Drain Voltage				25	V

### Recommended Operating Conditions

Parameter	Value
Drain Voltage	25 V
Drain Current (quiescent, $I_{DQ}$ )	200 mA
Drain Current (under drive, $I_D$ )	3.7 A
Gate Voltage	-2.8 V
Operating Temperature Range	-40 to 85 °C

Electrical specifications are measured at specified test conditions. Specifications are not guaranteed over all recommended operating conditions.

### Performance Plots – Large Signal (Pulsed)

Test conditions unless otherwise noted: Temp. = 25 °C,  $V_D = 25$  V,  $I_{DQ} = 200$  mA, PW = 100 us, Duty Cycle = 10%

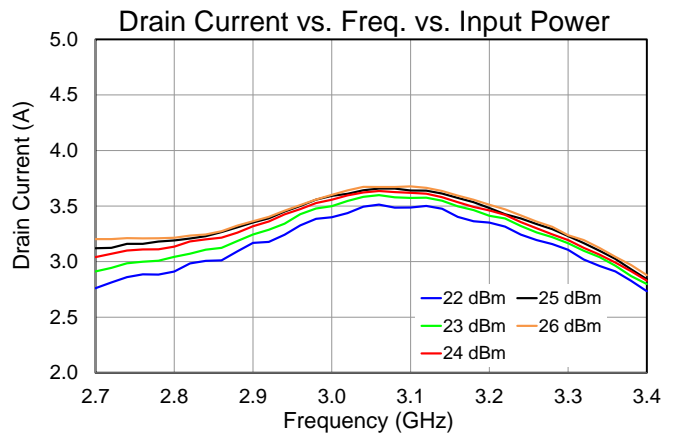
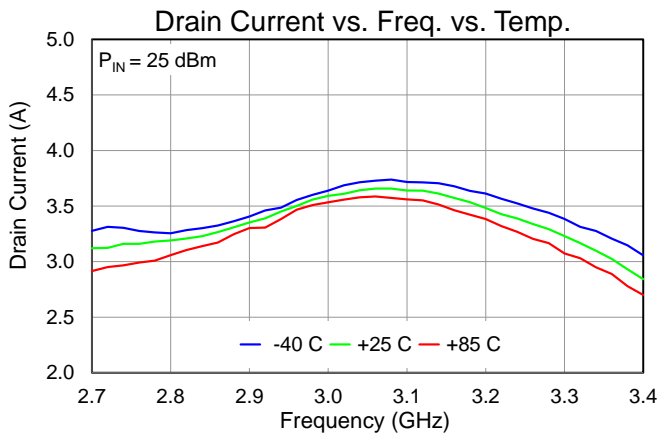
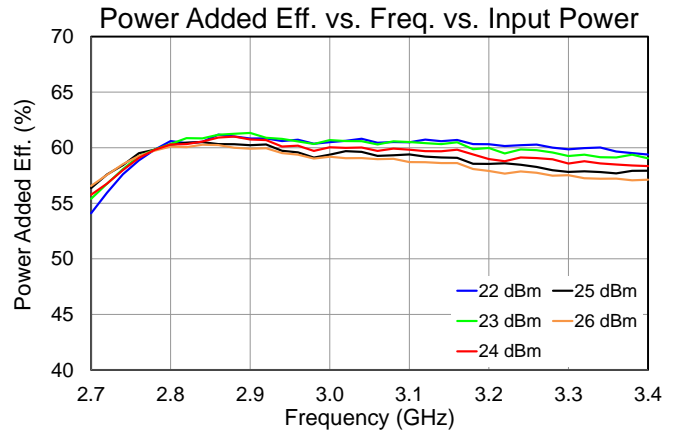
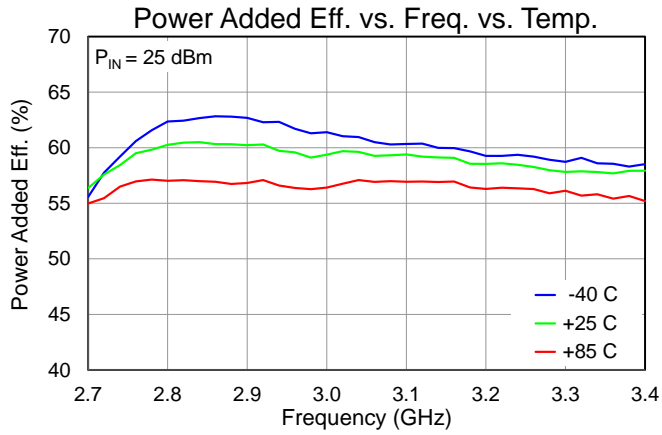
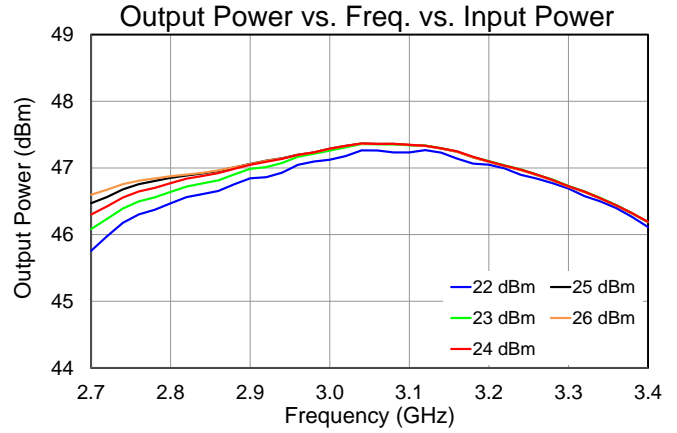
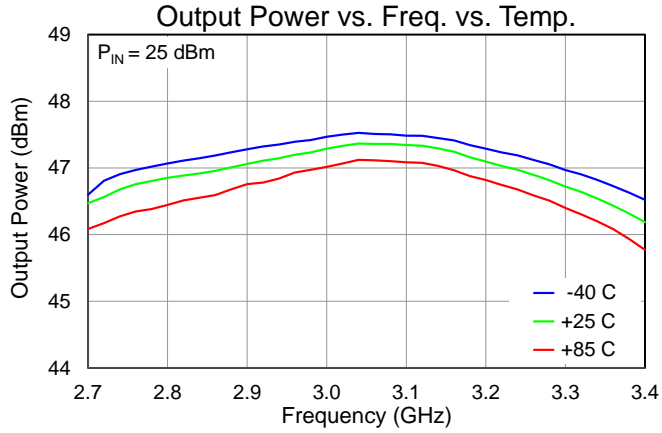

### Performance Plots – Large Signal (Pulsed)

Test conditions unless otherwise noted: Temp. = 25 °C,  $V_D = 25$  V,  $I_{DQ} = 200$  mA, PW = 100 us, Duty Cycle = 10%

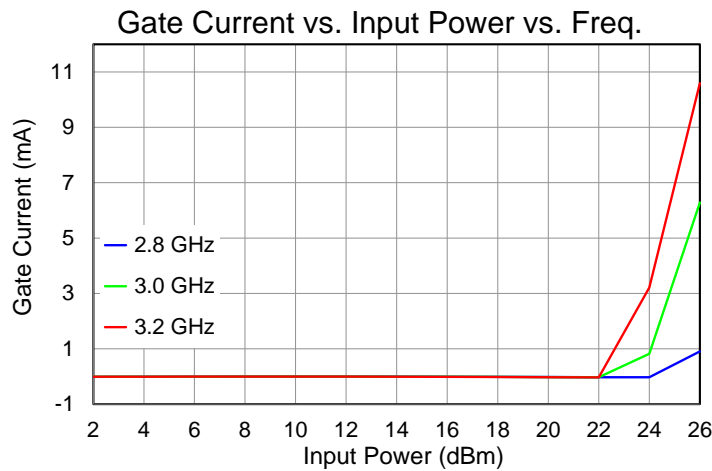
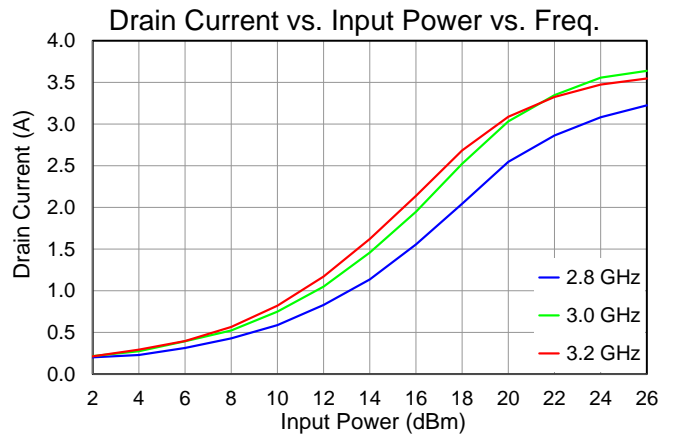
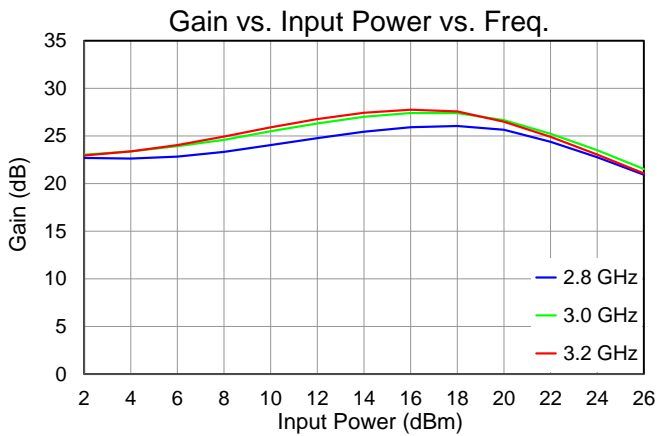
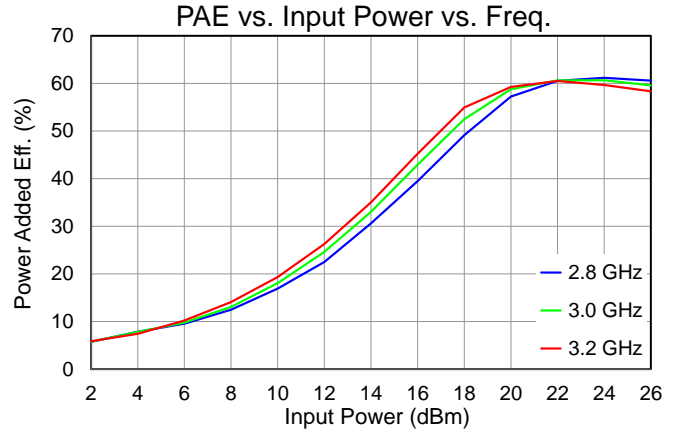
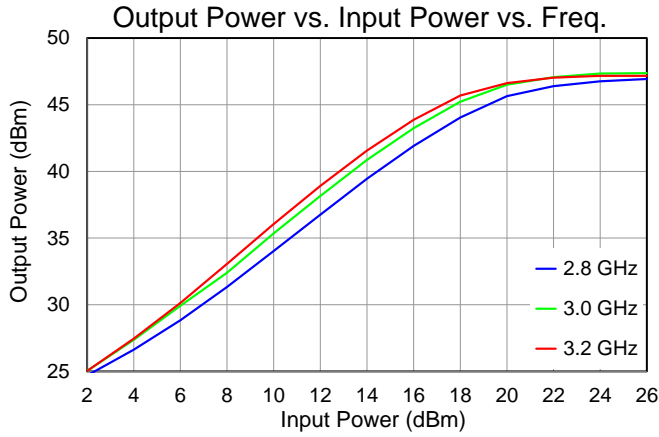

### Performance Plots – Large Signal (Pulsed)

Test conditions unless otherwise noted: Temp. = 25 °C,  $V_D = 25$  V,  $I_{DQ} = 200$  mA, PW = 100 us, Duty Cycle = 10%

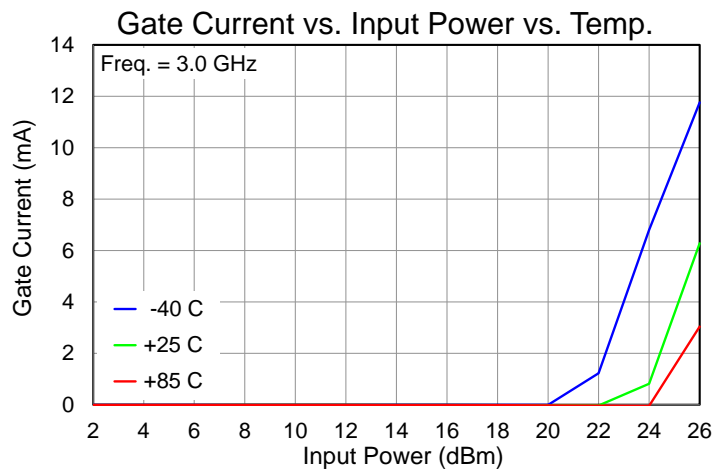
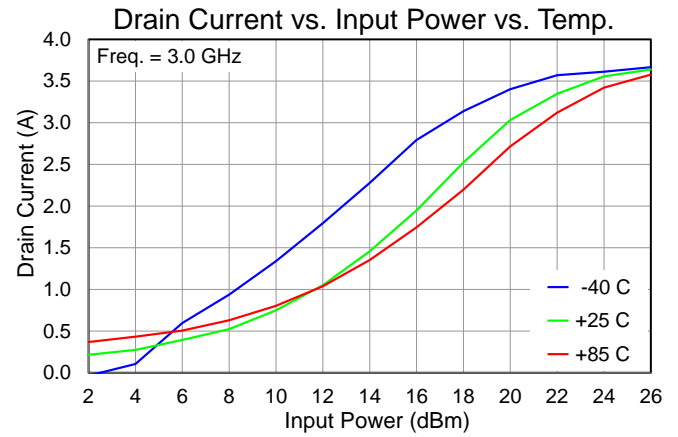
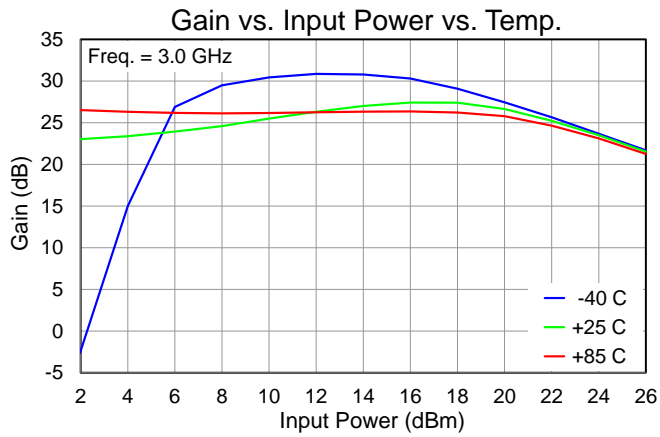
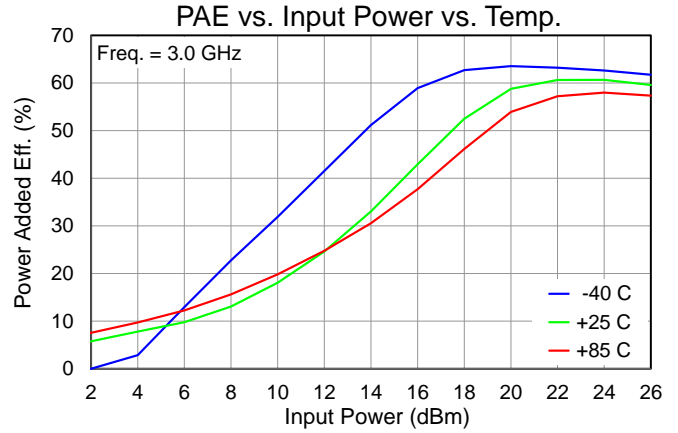
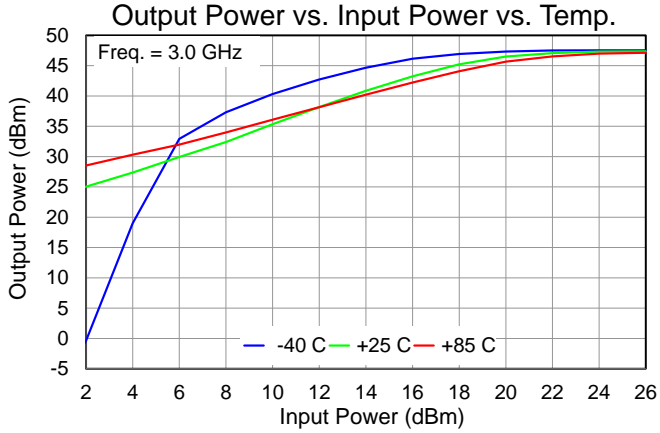

### Performance Plots – Small Signal

Test conditions unless otherwise noted: Temp. = 25 °C,  $V_D = 25$  V,  $I_{DQ} = 200$  mA

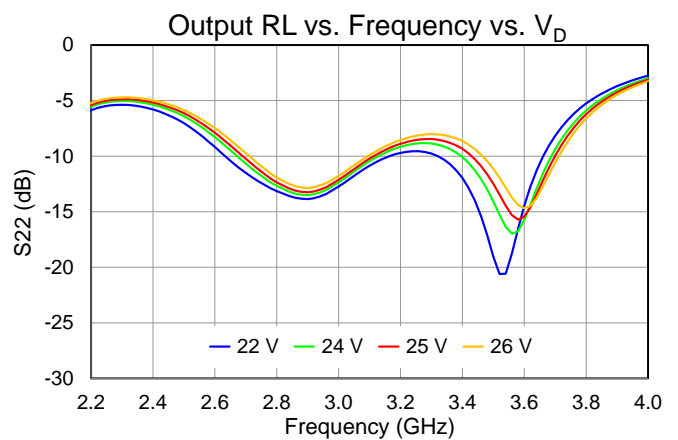
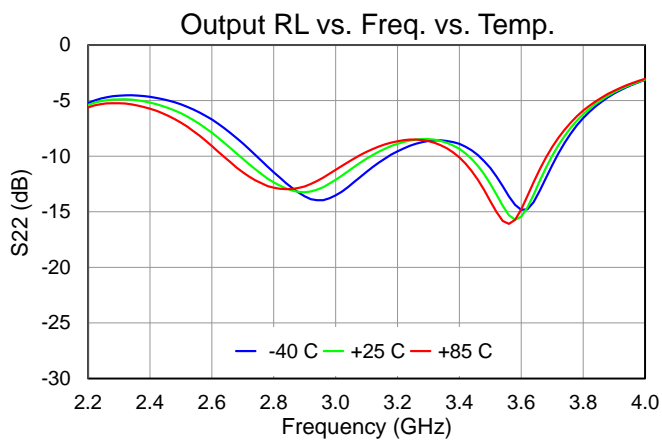
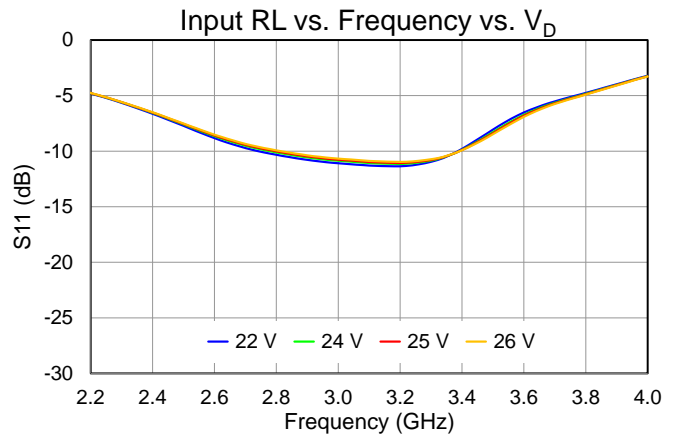
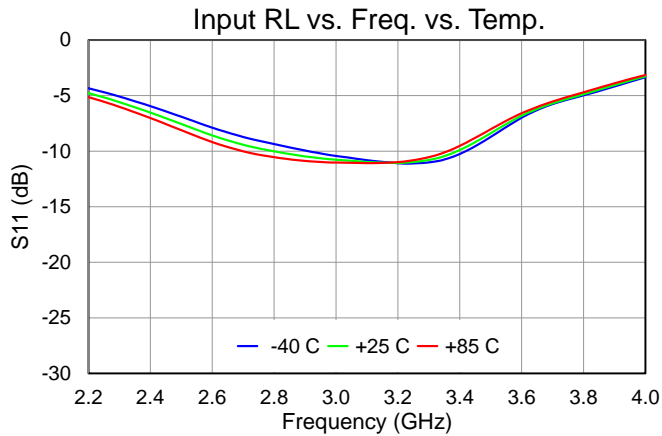
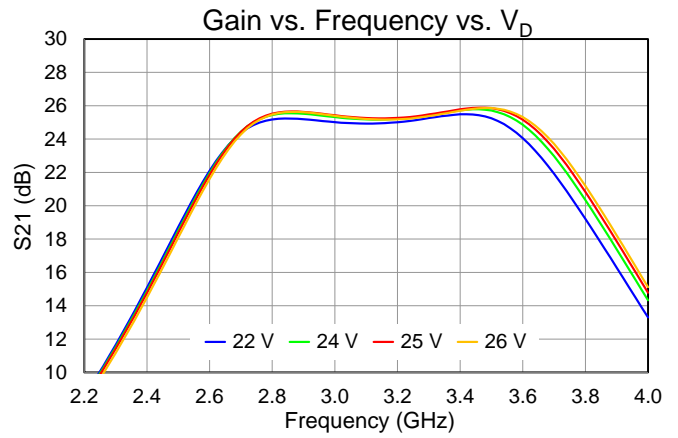
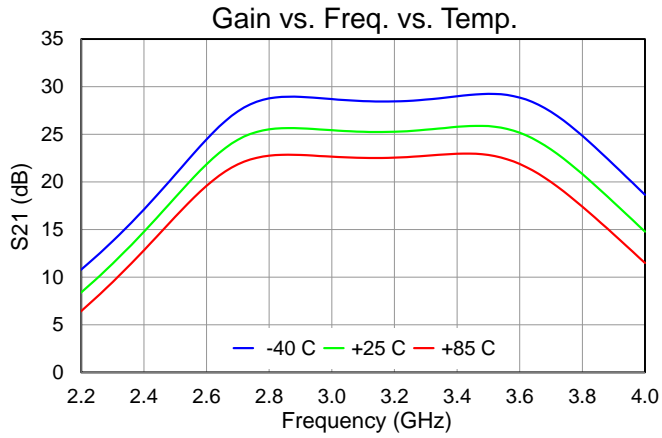

### Performance Plots – Small Signal

Test conditions unless otherwise noted: Temp. = 25 °C,  $V_D = 25$  V,  $I_{DQ} = 200$  mA

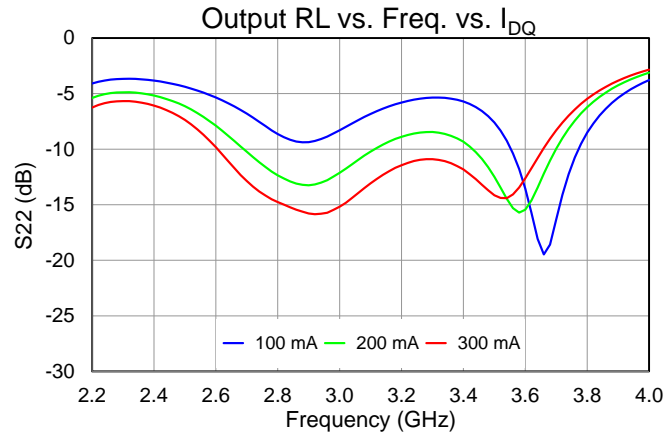
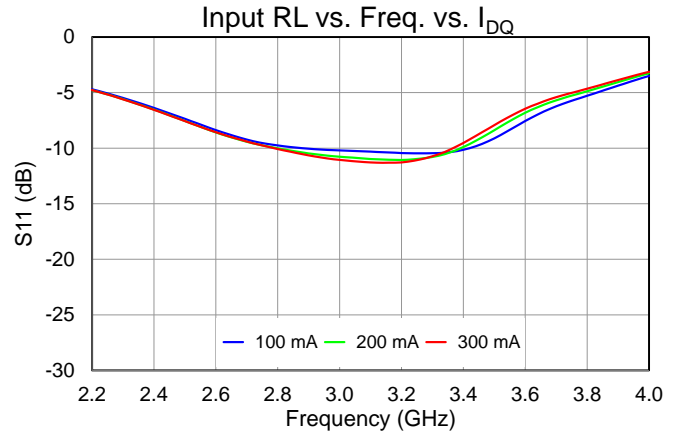
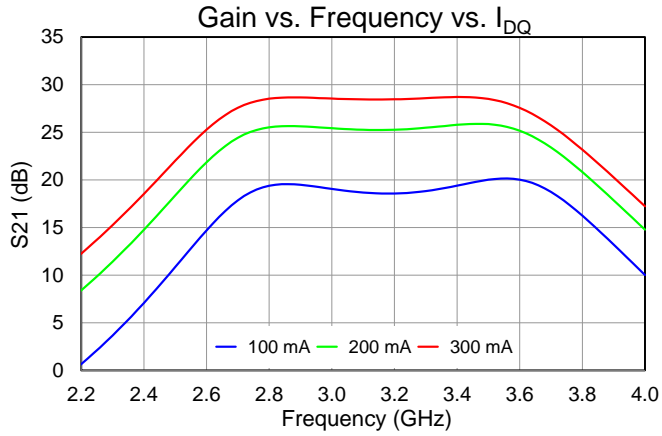

### Thermal and Reliability Information

Parameter	Test Conditions	Value	Units
Thermal Resistance ( $\theta_{JC}$ ) <sup>(1)</sup>	$T_{base} = 85^{\circ}C$	0.6	$^{\circ}C/W$
Channel Temperature ( $T_{CH}$ ) (Quiescent)	$V_D = 25 V, I_{DQ} = 200 mA$ $P_{DISS} = 5.0 W$	88	$^{\circ}C$
Thermal Resistance ( $\theta_{JC}$ ) <sup>(1)</sup>	$T_{base} = 85^{\circ}C, V_D = 25 V, I_{DQ} = 200 mA, Freq = 2.8 GHz,$	0.65	$^{\circ}C/W$
Channel Temperature ( $T_{CH}$ ) (Under RF drive)	$I_{D\_Drive} = 3.6 A, P_{IN} = 26 dBm, P_{OUT} = 46.6 dBm,$ $P_{DISS} = 33.9 W, PW = 100 \mu s, DC = 10\%$	107	$^{\circ}C$
Thermal Resistance ( $\theta_{JC}$ ) <sup>(1)</sup>	$T_{base} = 85^{\circ}C, V_D = 25 V, I_{DQ} = 200 mA, Freq = 3.1 GHz,$	0.66	$^{\circ}C/W$
Channel Temperature ( $T_{CH}$ ) (Under RF drive)	$I_{D\_Drive} = 3.8 A, P_{IN} = 26 dBm, P_{OUT} = 47.1 dBm,$ $P_{DISS} = 39.4 W, PW = 100 \mu s, DC = 10\%$	111	$^{\circ}C$

Notes:

1. Thermal resistance measured to back of package.
2. Refer to the following document: [GaN Device Channel Temperature, Thermal Resistance, and Reliability Estimates](#)

### Power Dissipation

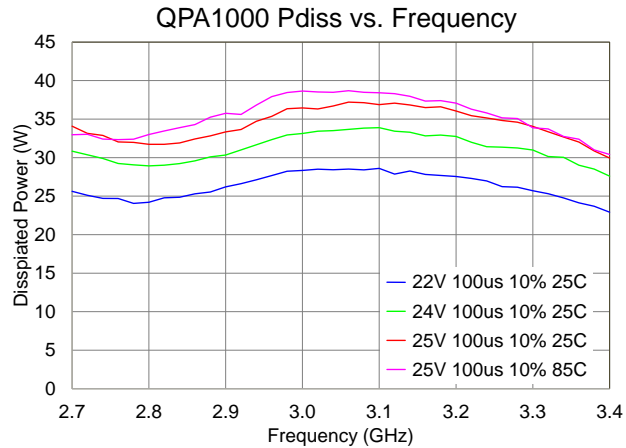



### Applications Circuit

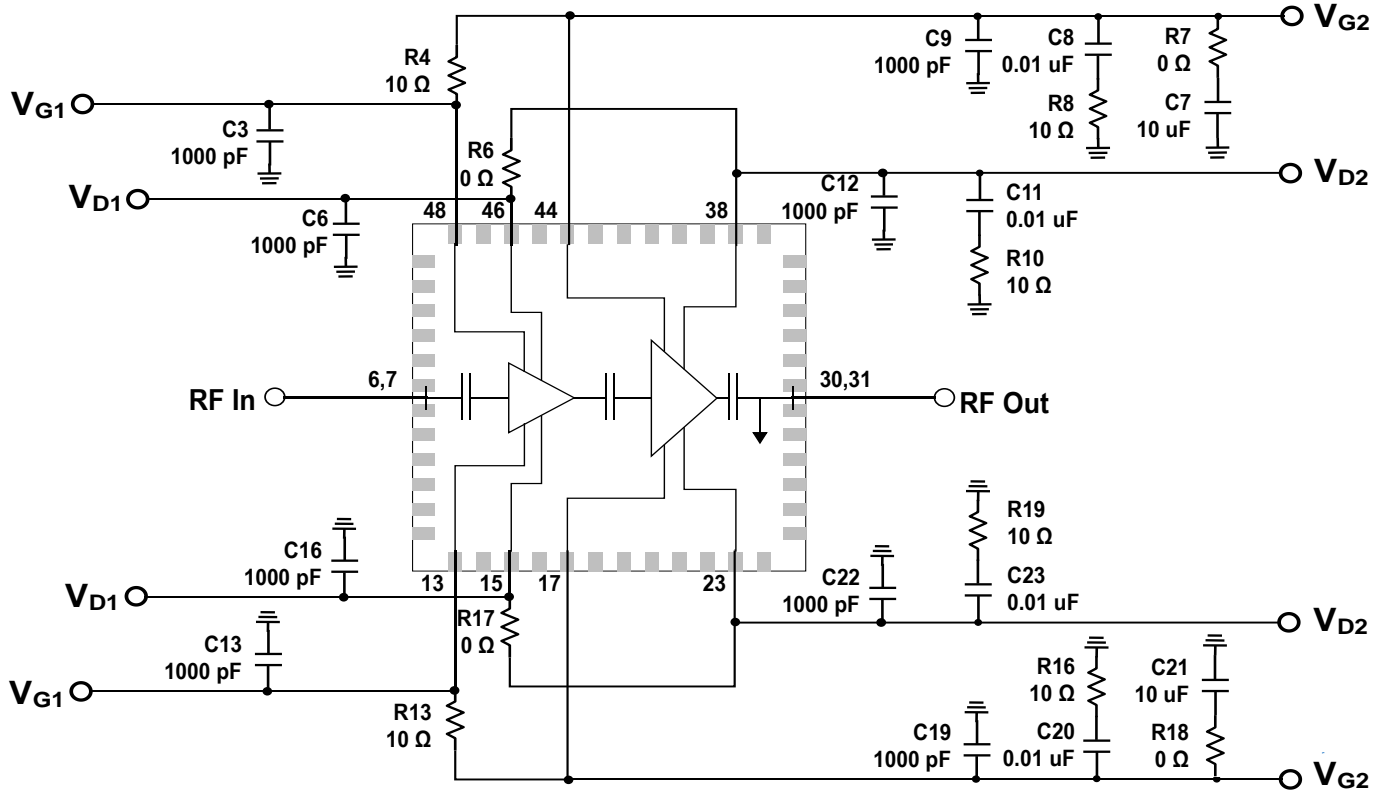

Notes:

1.  $V_G$  and  $V_D$  must be biased from both sides (top and bottom).

### Bias Up Procedure

1. Set  $I_D$  limit to 6000 mA,  $I_G$  limit to 40 mA
2. Set  $V_G$  to -6.0 V
3. Set  $V_D$  +25 V
4. Adjust  $V_G$  more positive until  $I_{DQ} = 200$  mA ( $V_G \sim -2.8$  V Typical)
5. Apply RF signal

### Bias Down Procedure

1. Turn off RF supply
2. Reduce  $V_G$  to -6.0 V. Ensure  $I_{DQ} \sim 0$  mA
3. Set  $V_D$  to 0 V
4. Turn off  $V_D$  supply
5. Turn off  $V_G$  supply

### Evaluation Board and Mounting Detail

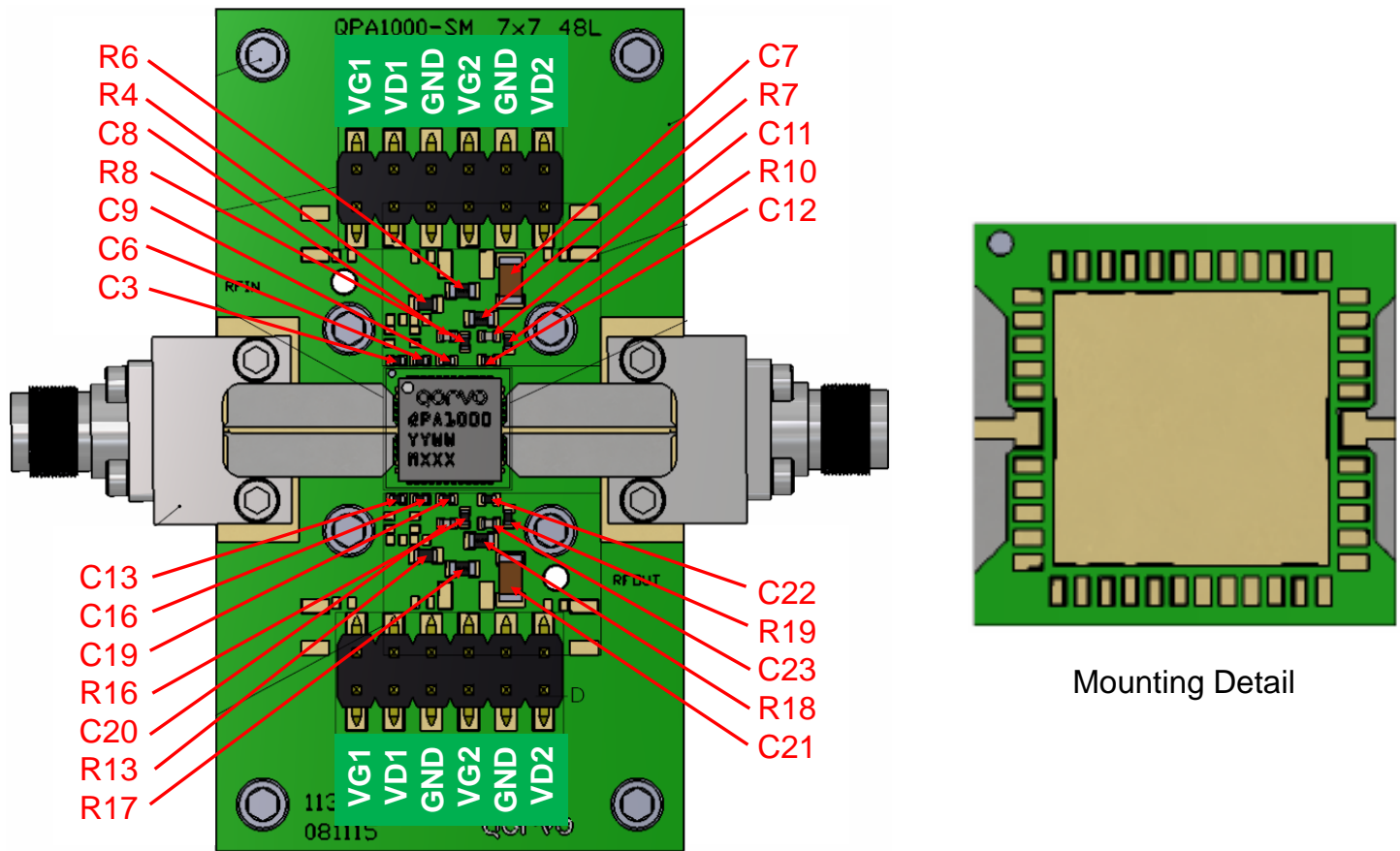

RF Layer is 0.008" thick Rogers Corp. RO40003C ( $\epsilon_r = 3.35$ ). Metal layers are 0.5 oz. copper. The microstrip line at the connector interface is optimized for the Southwest Microwave end launch connector 1092-02A-5.

### Bill of Materials

Ref. Des.	Component	Value	Manuf.	Part Number
C7, C21	Surface Mount Cap.	CAP, 1206, 10uF, 20%, 50V, 20%, X5R	Various	
C3, C6, C9, C12, C13, C16, C19, C22	Surface Mount Cap.	CAP, 0402, 1000pF, 10%, 100V, X7R	Various	
C8, C11, C20, C23	Surface Mount Cap.	CAP, 0402, 0.01uF, $\pm 10\%$ , 50V, X7R	Various	
R8, R10, R16, R19	Surface Mount Res.	RES, 10 OHM $\pm 5\%$ 0402	Various	
R4, R13	Surface Mount Res.	RES, 10 OHM 1/10W $\pm 5\%$ 0603	Various	
R6, R7, R16, R18	Surface Mount Res.	RES, 0 OHM 5% 0603	Various	

### Mechanical Information

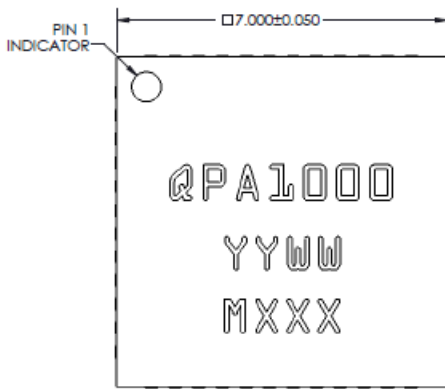

A		QFN
	MAX.	0.900
	NOM.	0.850
	MIN.	0.800

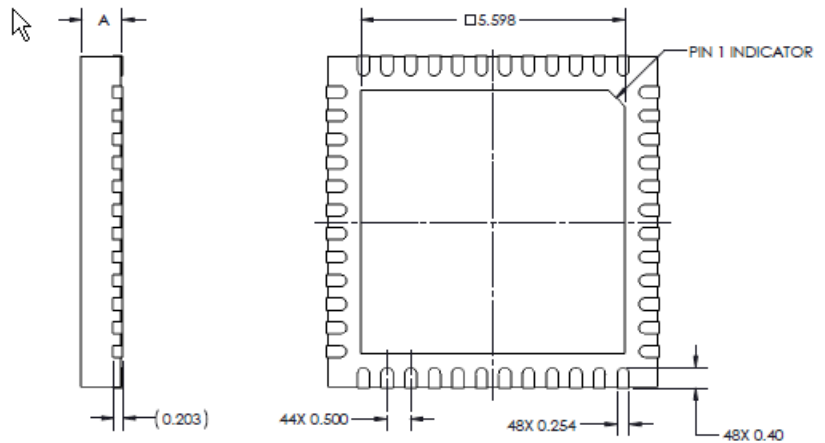

NOTES:  
PACKAGE METAL BASE AND LEADS  
ARE GOLD PLATED.

PART MARKING:  
QPA1000: PART NUMBER  
YY: PART ASSY YEAR  
WW: PART ASSY WEEK  
MXXX: LOT NUMBER

DIMENSIONS IN MM

### Pin Description

Pin Number	Symbol	Description
1-5, 8-12, 14, 16, 18-22, 24-29, 32-37, 39-43, 45, 47	NC	No connection. Can be grounded on PCB if desired.
6, 7	RF Input	50 Ohm RF input. Pad is capacitively coupled to block on-chip DC voltages.
13, 48	V <sub>G1</sub>	1 <sup>st</sup> Stage Gate Voltage; bias network is required; must be biased from both sides (V <sub>G1</sub> and V <sub>G2</sub> can be tied together in application)
15, 46	V <sub>D1</sub>	1 <sup>st</sup> Stage Drain Voltage; bias network is required; must be biased from both sides (V <sub>D1</sub> and V <sub>D2</sub> can be tied together in application)
17, 44	V <sub>G2</sub>	2 <sup>nd</sup> Stage Gate Voltage; bias network is required; must be biased from both sides (V <sub>G1</sub> and V <sub>G2</sub> can be tied together in application)
23, 38	V <sub>D2</sub>	2 <sup>nd</sup> Stage Drain Voltage; bias network is required; must be biased from both sides (V <sub>D1</sub> and V <sub>D2</sub> can be tied together in application)
30, 31	RF Output	50 Ohm RF output. Pad is capacitively coupled to block on-chip DC voltages. Pad is DC grounded.
49	GND	Ground connection.

### Absolute Maximum Ratings

Parameter	Value / Range
Drain Voltage ( $V_D$ )	40 V
Drain Current ( $I_{D1}/I_{D2}$ )	0.77/3.84 A
Gate Voltage Range	-8 to 0 V
Gate Current ( $I_G$ )	See $I_{G\_Max}$ plot
Dissipated Power ( $P_{DISS}$ ) <sup>1</sup>	44.25 W
Input Power (50 $\Omega$ , 85 °C)	33 dBm
Input Power (9:1 VSWR, 85 °C)	33 dBm
Mounting Temperature (30 seconds)	260 °C
Storage Temperature	-55 to 150 °C

Note:  
<sup>1</sup>  $T_{BASE} = 85\text{ °C}$ ,  $T_{CH} = 225\text{ °C}$

Operation of this device outside the parameter ranges given above may cause permanent damage. These are stress ratings only, and functional operation of the device at these conditions is not implied.

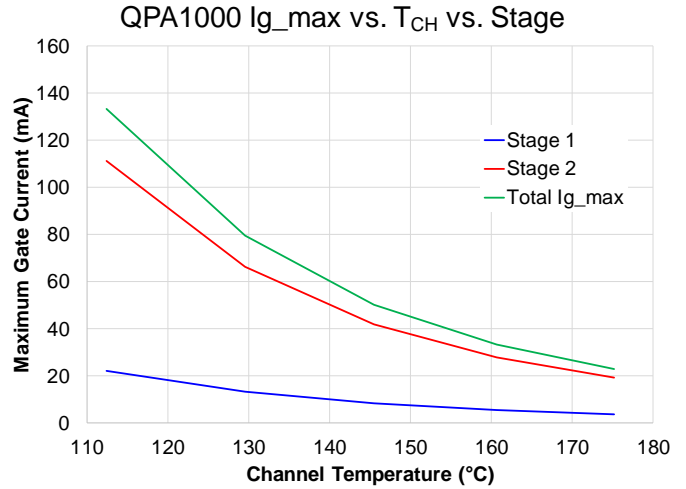

### Recommended Soldering Temperature Profile

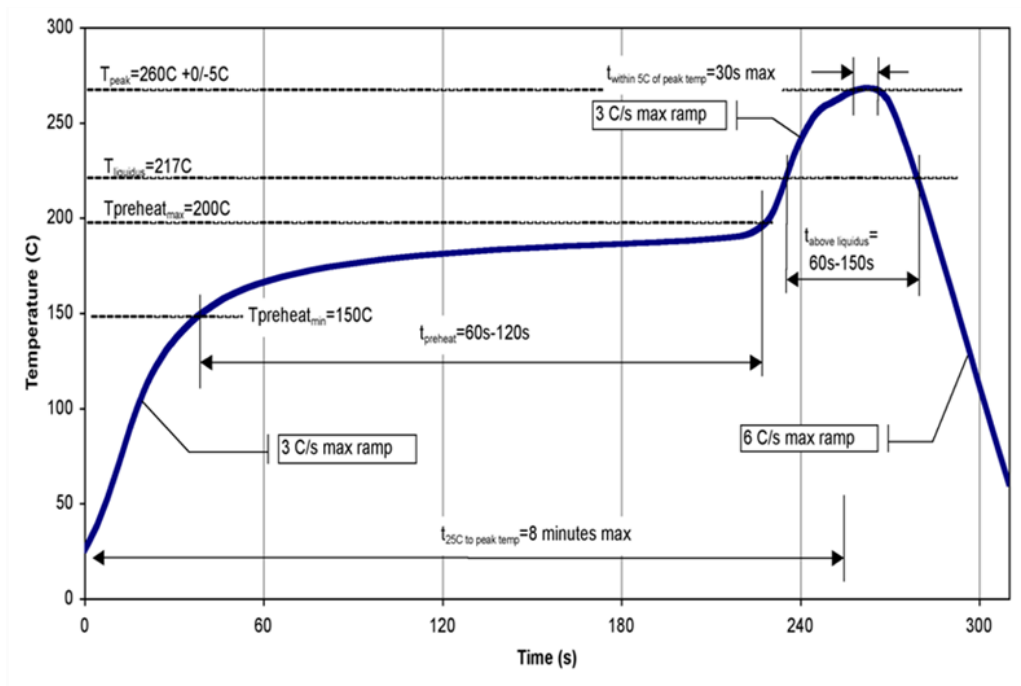

## Handling Precautions

Parameter	Rating	Standard
ESD – Human Body Model (HBM)	Class 0B	ANSI/ESD/JEDEC JS-001
ESD – Charge Device Model (CDM)	Class C3	ANSI/ESD/JEDEC JS-002
MSL – Moisture Sensitivity Level	Level 3	IPC/JEDEC J-STD-020



Caution!  
ESD-Sensitive Device

## Solderability

Compatible with the latest version of J-STD-020 Lead free solder, 260 °C.  
Solder profiles available upon request.

## RoHS Compliance

This product is compliant with the 2011/65/EU RoHS directive (Restrictions on the Use of Certain Hazardous Substances in Electrical and Electronic Equipment), as amended by Directive 2015/863/EU. This product also has the following attributes:

- Lead Free
- Halogen Free (Chlorine, Bromine)
- Antimony Free
- TBBP-A (C<sub>15</sub>H<sub>12</sub>Br<sub>4</sub>O<sub>2</sub>) Free
- PFOS Free
- SVHC Free
- Qorvo Green

## Contact Information

For the latest specifications, additional product information, worldwide sales and distribution locations:

**Tel: 1-844-890-8163**

**Web: [www.qorvo.com](http://www.qorvo.com)**

**Email: [customer.support@qorvo.com](mailto:customer.support@qorvo.com)**

## Important Notice

The information contained herein is believed to be reliable; however, Qorvo makes no warranties regarding the information contained herein and assumes no responsibility or liability whatsoever for the use of the information contained herein. All information contained herein is subject to change without notice. Customers should obtain and verify the latest relevant information before placing orders for Qorvo products. The information contained herein or any use of such information does not grant, explicitly or implicitly, to any party any patent rights, licenses, or any other intellectual property rights, whether with regard to such information itself or anything described by such information. **THIS INFORMATION DOES NOT CONSTITUTE A WARRANTY WITH RESPECT TO THE PRODUCTS DESCRIBED HEREIN, AND QORVO HEREBY DISCLAIMS ANY AND ALL WARRANTIES WITH RESPECT TO SUCH PRODUCTS WHETHER EXPRESS OR IMPLIED BY LAW, COURSE OF DEALING, COURSE OF PERFORMANCE, USAGE OF TRADE OR OTHERWISE, INCLUDING THE IMPLIED WARRANTIES OF MERCHANTABILITY AND FITNESS FOR A PARTICULAR PURPOSE.**

Without limiting the generality of the foregoing, Qorvo products are not warranted or authorized for use as critical components in medical, life-saving, or life-sustaining applications, or other applications where a failure would reasonably be expected to cause severe personal injury or death.

Copyright 2018 © Qorvo, Inc. | Qorvo is a registered trademark of Qorvo, Inc.