

Features

- 5mm Through hole, 8.65mm lens height
- High Brightness
- Water Clear lens
- InGaN / AlInGaP Technology
- Special packaging available upon request
- High reliability

Applications

- Consumer Electronics
- Variable Message Signs (VMS)
- Automobile After Market
- Industrial Equipment
- Advertising Signs

Description

The INL-5AX30 is high brightness 30 degrees through-hole lamp. It is a 5mm epoxy type LED which can be used in various applications.

Package Dimensions in mm

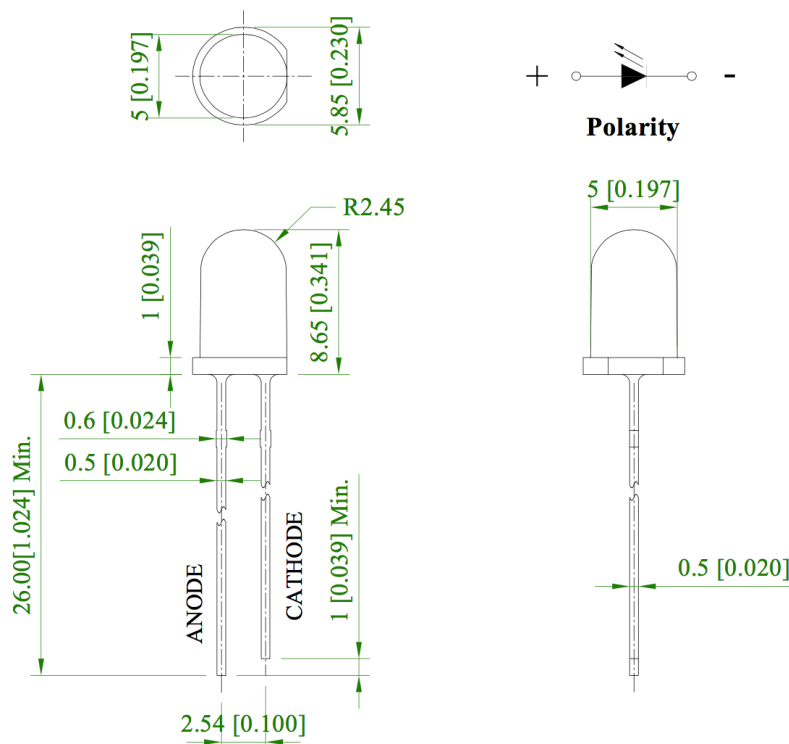

Figure 1. INL-5AX30 Package Dimensions

Absolute Maximum Rating at 25°C (Note 1)

| Product | Emission Color | P_d (mW) | I_F (mA) | I_{FP}^* (mA) | V_R (V) | T_{OP} (°C) | T_{ST} (°C) |
|------------|----------------|------------|------------|-----------------|-----------|---------------|---------------|
| INL-5AYG30 | Yellow Green | 65 | 25 | 100 | 5 | -40°C~+85°C | -40°C~+100°C |
| INL5AY30 | Yellow | | | | | | |
| INL5AA30 | Amber | | | | | | |
| INL5AR30 | Red | | | | | | |
| INL5AB30 | Blue | 95 | 25 | 100 | | | |
| INL5AG30 | Green | | | | | | |
| INL5AW30 | White | | | | | | |

Notes

1. Condition for I_{FP} is pulse of 1/10 duty and 0.1msec width

Electrical Characteristics $T_A = 25^\circ\text{C}$ (Note 1)

| Product | Emission Color | $I_F(\text{mA})$ | $V_F(\text{V})$ | | $\lambda(\text{nm})$ | | | Viewing Angle | $I_v(\text{mcd})$ | |
|------------|----------------|------------------|-----------------|-----|----------------------|-------------|-----------------|-----------------|-------------------|-------|
| | | | min | max | λ_D | λ_P | $\Delta\lambda$ | $2\theta_{1/2}$ | min | typ. |
| INL-5AYG30 | Yellow Green | 20 | 1.6 | 2.6 | 573 | 575 | 20 | 30 | 270 | 460 |
| INL5AY30 | Yellow | 20 | 1.6 | 2.6 | 590 | 592 | 15 | 30 | 600 | 1000 |
| INL5AA30 | Amber | 20 | 1.6 | 2.6 | 605 | 610 | 35 | 30 | 460 | 780 |
| INL5AR30 | Red | 20 | 1.6 | 2.6 | 624 | 632 | 20 | 30 | 780 | 1300 |
| INL5AB30 | Blue | 20 | 2.6 | 3.8 | 470 | 468 | 25 | 30 | 2900 | 5000 |
| INL5AG30 | Green | 20 | 2.6 | 3.6 | 525 | 520 | 35 | 30 | 14000 | 23000 |
| INL5AW30 | White | 20 | 2.8 | 3.8 | X = 0.28 Y = 0.28 | | | 30 | 6500 | 8500 |

Notes

1. Performance guaranteed only under conditions listed in above tables.

ESD Precaution

ATTENTION: Electrostatic Discharge (ESD) protection



The symbol above denotes that ESD precaution is needed. ESD protection for GaP and AlGaAs based chips is necessary even though they are relatively safe in the presence of low static-electric discharge. Parts built with AlInGaP, GaN, or/and InGaN based chips are STATIC SENSITIVE devices. ESD precaution must be taken during design and assembly. If manual work or processing is needed, please ensure the device is adequately protected from ESD during the process.

Please be advised that normal static precautions should be taken in the handling and assembly of this device to prevent damage or degradation which may be induced by electrostatic discharge (ESD).

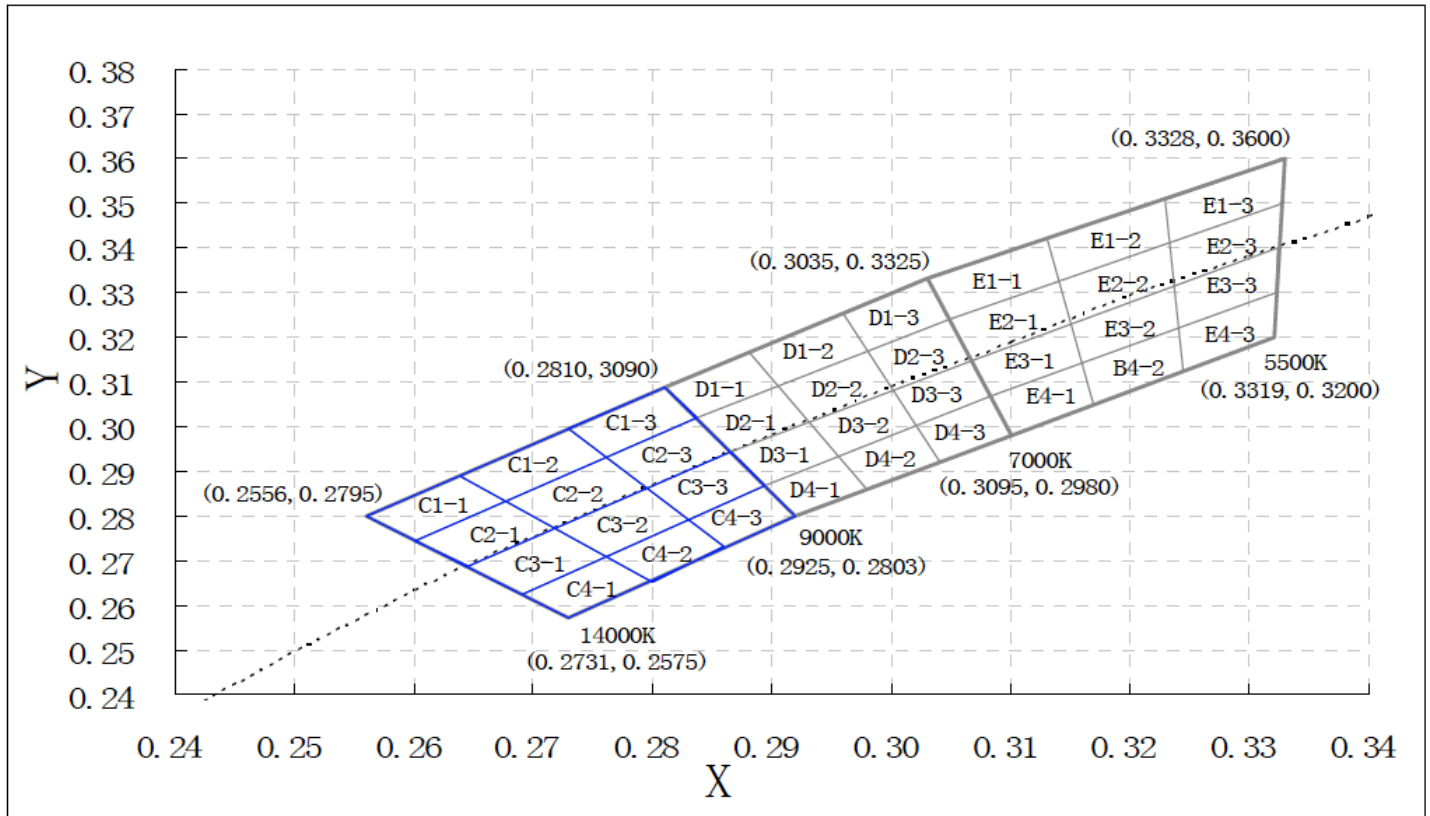
Chromaticity Bin (For White Only)

| Bin Code | Left x | Left y | Top x | Top y | Right x | Right y | Bottom x | Bottom y |
|----------|--------|--------|-------|-------|---------|---------|----------|----------|
| C1-1 | 0.256 | 0.28 | 0.264 | 0.289 | 0.268 | 0.283 | 0.26 | 0.274 |
| C2-1 | 0.26 | 0.274 | 0.268 | 0.283 | 0.272 | 0.277 | 0.264 | 0.269 |
| C3-1 | 0.264 | 0.269 | 0.272 | 0.277 | 0.276 | 0.271 | 0.269 | 0.263 |
| C4-1 | 0.269 | 0.263 | 0.276 | 0.271 | 0.28 | 0.265 | 0.273 | 0.257 |
| C1-2 | 0.264 | 0.289 | 0.273 | 0.299 | 0.276 | 0.293 | 0.268 | 0.283 |
| C2-2 | 0.268 | 0.283 | 0.276 | 0.293 | 0.279 | 0.286 | 0.272 | 0.277 |
| C3-2 | 0.272 | 0.277 | 0.279 | 0.286 | 0.283 | 0.279 | 0.276 | 0.271 |
| C4-2 | 0.276 | 0.271 | 0.283 | 0.279 | 0.286 | 0.273 | 0.28 | 0.265 |
| C1-3 | 0.273 | 0.299 | 0.281 | 0.309 | 0.284 | 0.302 | 0.276 | 0.293 |
| C2-3 | 0.276 | 0.293 | 0.284 | 0.302 | 0.287 | 0.295 | 0.279 | 0.286 |
| C3-3 | 0.279 | 0.286 | 0.287 | 0.295 | 0.29 | 0.287 | 0.283 | 0.279 |
| C4-3 | 0.283 | 0.279 | 0.29 | 0.287 | 0.292 | 0.28 | 0.286 | 0.273 |
| D1-1 | 0.281 | 0.309 | 0.288 | 0.317 | 0.291 | 0.309 | 0.284 | 0.302 |
| D2-1 | 0.284 | 0.302 | 0.291 | 0.309 | 0.293 | 0.302 | 0.287 | 0.295 |
| D3-1 | 0.287 | 0.295 | 0.293 | 0.302 | 0.296 | 0.294 | 0.29 | 0.287 |
| D4-1 | 0.29 | 0.287 | 0.296 | 0.294 | 0.298 | 0.286 | 0.292 | 0.28 |
| D1-2 | 0.288 | 0.317 | 0.296 | 0.325 | 0.298 | 0.317 | 0.291 | 0.309 |
| D2-2 | 0.291 | 0.309 | 0.298 | 0.317 | 0.3 | 0.308 | 0.293 | 0.302 |
| D3-2 | 0.293 | 0.302 | 0.3 | 0.308 | 0.302 | 0.3 | 0.296 | 0.294 |
| D4-2 | 0.296 | 0.294 | 0.302 | 0.3 | 0.304 | 0.292 | 0.298 | 0.286 |
| D1-3 | 0.296 | 0.325 | 0.303 | 0.333 | 0.305 | 0.324 | 0.298 | 0.317 |
| D2-3 | 0.298 | 0.317 | 0.305 | 0.324 | 0.307 | 0.315 | 0.3 | 0.308 |
| D3-3 | 0.3 | 0.308 | 0.307 | 0.315 | 0.308 | 0.307 | 0.302 | 0.3 |
| D4-3 | 0.302 | 0.3 | 0.308 | 0.307 | 0.31 | 0.298 | 0.304 | 0.292 |
| E1-1 | 0.303 | 0.333 | 0.313 | 0.342 | 0.314 | 0.333 | 0.305 | 0.324 |
| E2-1 | 0.305 | 0.324 | 0.314 | 0.333 | 0.315 | 0.324 | 0.307 | 0.315 |
| E3-1 | 0.307 | 0.315 | 0.315 | 0.324 | 0.316 | 0.314 | 0.308 | 0.307 |
| E4-1 | 0.308 | 0.307 | 0.316 | 0.314 | 0.317 | 0.305 | 0.31 | 0.298 |
| E1-2 | 0.313 | 0.342 | 0.323 | 0.351 | 0.323 | 0.341 | 0.314 | 0.333 |
| E2-2 | 0.314 | 0.333 | 0.323 | 0.341 | 0.324 | 0.332 | 0.315 | 0.324 |
| E3-2 | 0.315 | 0.324 | 0.324 | 0.332 | 0.324 | 0.322 | 0.316 | 0.314 |
| E4-2 | 0.316 | 0.314 | 0.324 | 0.322 | 0.324 | 0.313 | 0.317 | 0.305 |
| E1-3 | 0.323 | 0.351 | 0.333 | 0.36 | 0.333 | 0.35 | 0.323 | 0.341 |
| E2-3 | 0.324 | 0.332 | 0.333 | 0.35 | 0.332 | 0.34 | 0.324 | 0.331 |
| E3-3 | 0.324 | 0.332 | 0.332 | 0.34 | 0.332 | 0.33 | 0.324 | 0.322 |
| E4-3 | 0.324 | 0.322 | 0.332 | 0.33 | 0.332 | 0.32 | 0.324 | 0.313 |

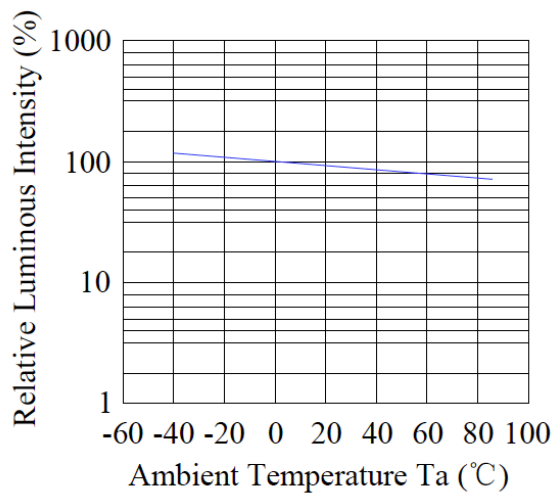
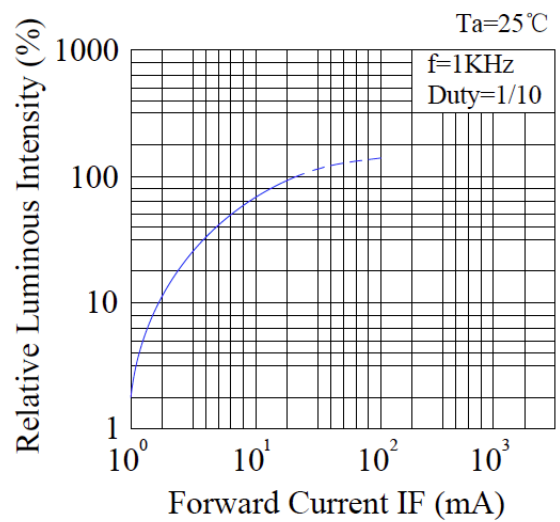
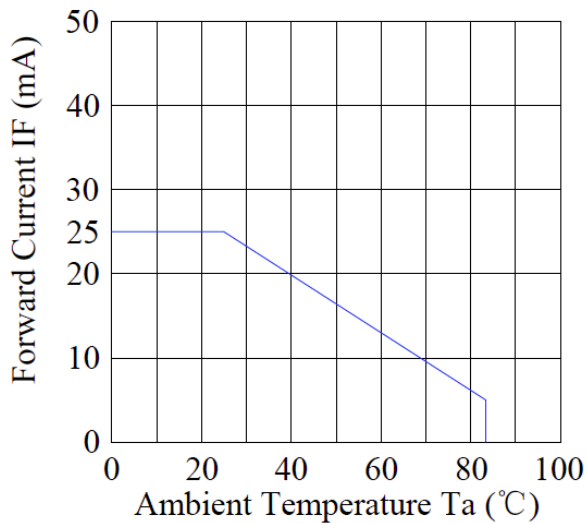
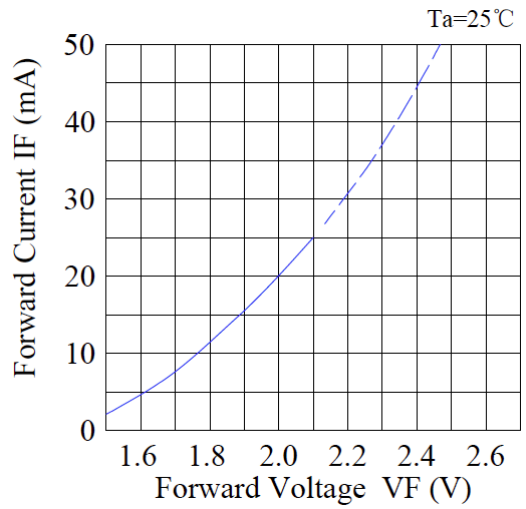
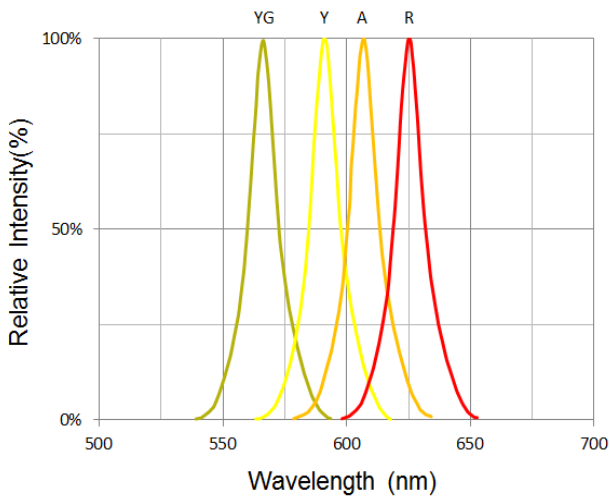
Typical Characteristic Curves – YG, Y, A, R

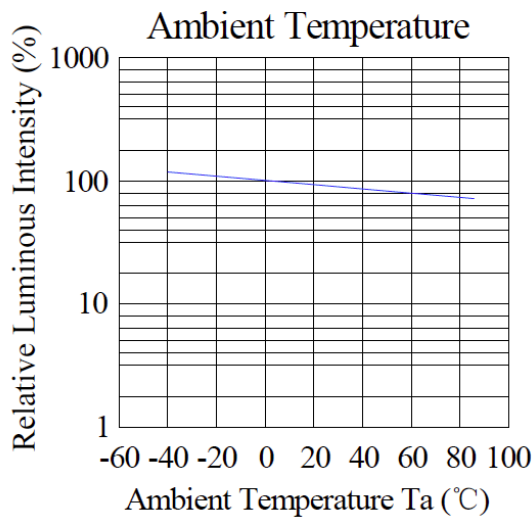
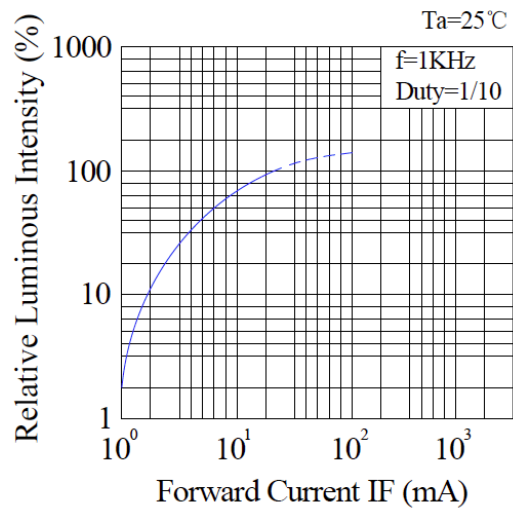
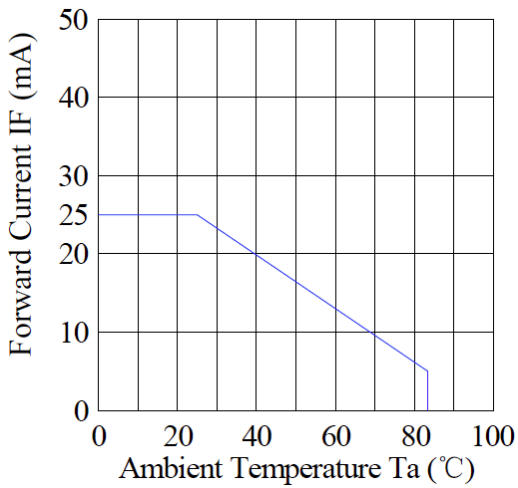
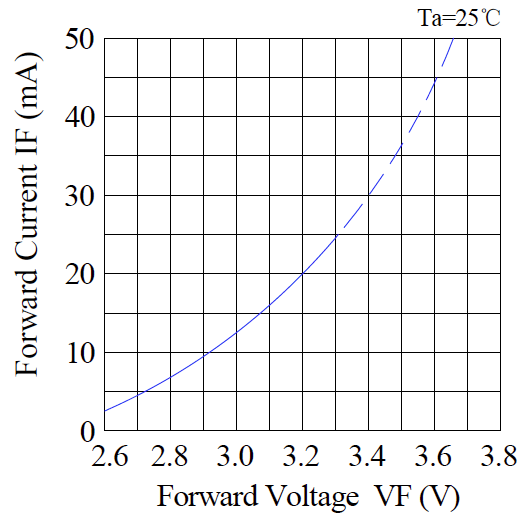
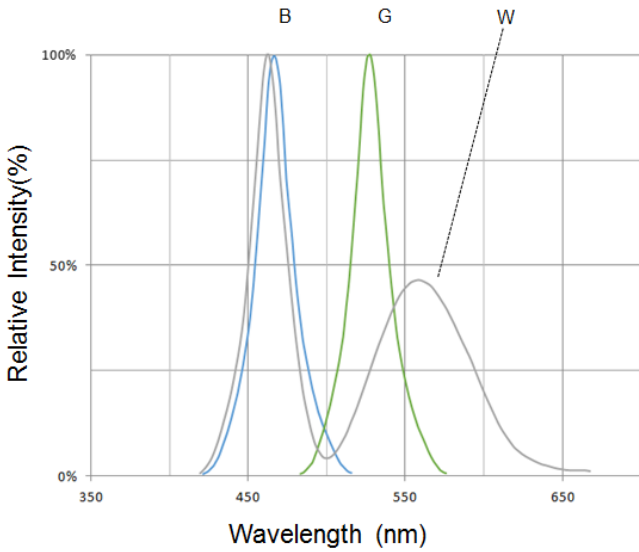
Typical Characteristic Curves – B, G, W

Typical Characteristic Curves – Radiation Pattern

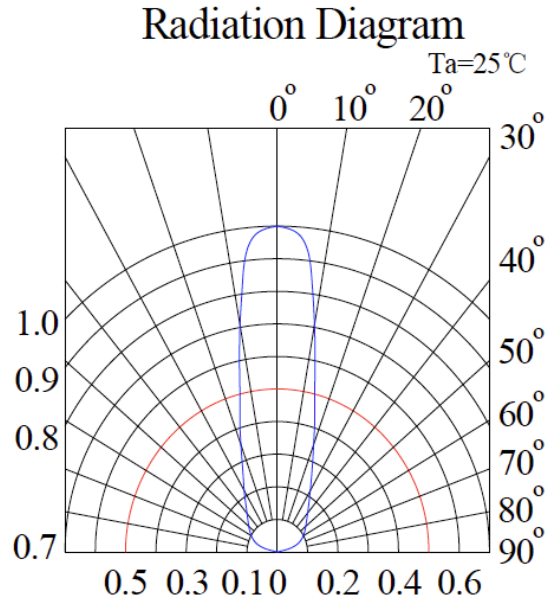

Ordering Information

| Product | Emission Color | Technology | Test Current I_F (mA) | Luminous Intensity I_V (mcd) (Typ.) | Forward Voltage V_F (V) (Typ.) | Orderable Part Number |
|------------|----------------|------------|-------------------------|---------------------------------------|----------------------------------|-----------------------|
| INL-5AYG30 | Yellow Green | AlInGaP | 20 | 460 | 2.0 | INL-5AYG30 |
| INL5AY30 | Yellow | AlInGaP | 20 | 1000 | 2.0 | INL5AY30 |
| INL5AA30 | Amber | AlInGaP | 20 | 780 | 2.0 | INL5AA30 |
| INL5AR30 | Red | AlInGaP | 20 | 1300 | 2.0 | INL5AR30 |
| INL5AB30 | Blue | InGaN | 20 | 5000 | 3.2 | INL5AB30 |
| INL5AG30 | Green | InGaN | 20 | 23000 | 3.2 | INL5AG30 |
| INL5AW30 | White | InGaN | 20 | 8500 | 3.3 | INL5AW30 |

Label Specifications

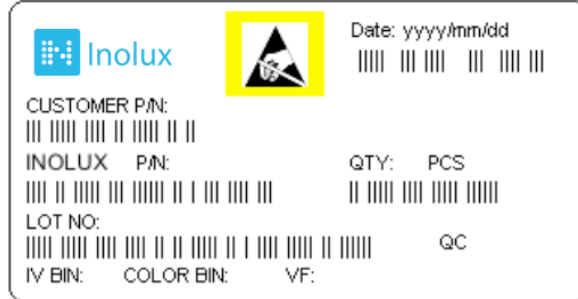

Inolux P/N:

| | | | | | | | | | | | | | | |
|--------------------------------|---|---|-------------------------------|--|--------------|-------------------------|---|---|---|---|---|---|---|---|
| I | N | L | - | 5 | A | | Y | 3 | 0 | - | X | X | X | X |
| Inolux Through Hole Lamp | | Material | Lens | Color | View Angle | Customized Stamp-off | | | | | | | | |
| | | 5A = 5mm with flange, 8.65 height | (Blank) = Clear Lens | R=636nm A=609nm Y=593nm YG=574nm G=530nm B=468nm W=White | 30 = 30 deg. | | | | | | | | | |

Lot No.:

| | | | | | | | |
|---------------------|--------------------------|---|---|---|-------|------|--------|
| Z | 2 | 0 | 1 | 7 | 01 | 24 | 001 |
| Internal Tracker | Year (2017, 2018,) | | | | Month | Date | Serial |

Soldering

Recommended soldering conditions:

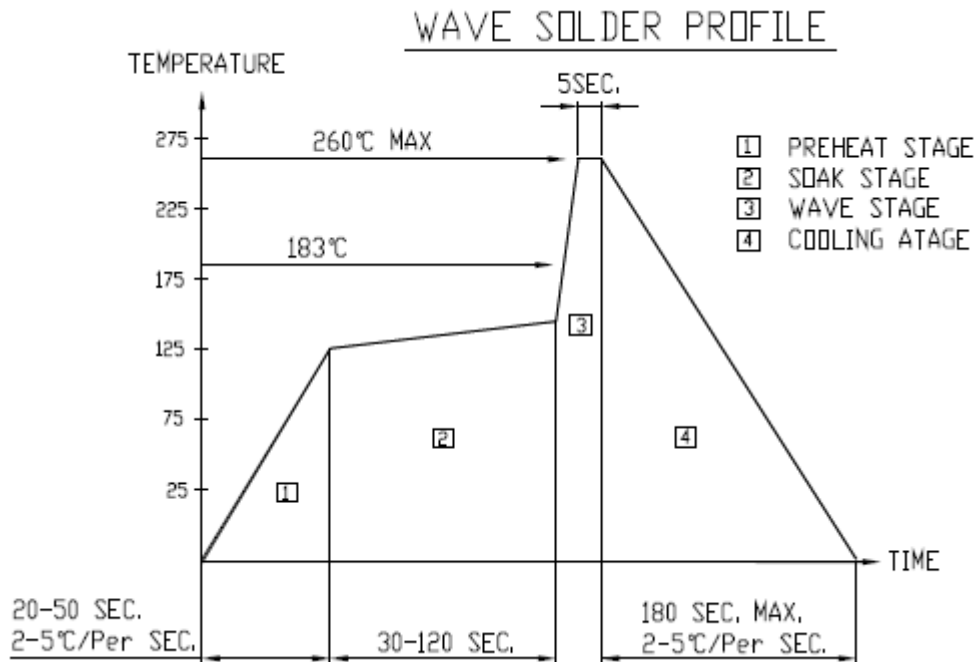

Soldering Iron

Basic Spec is Max 3 sec. @ 300°C. Lamps without stopper must leave a min. of 3mm clearance from base of the lens to the soldering point.

Rework

Caution is advised when rework is performed. Rework should be completed within 4 second under 245°C using a double-headed soldering iron.

Reliability

| Item | Frequency/ lots/ samples/ failures | Standards Reference | Conditions |
|--------------------------------------|---|--------------------------------|--|
| Precondition | For all reliability monitoring tests according to JEDEC Level 2 | J-STD-020 | 1.) Baking at 85°C for 24hrs 2.) Moisture storage at 85°C/ 60% R.H. for 168hrs |
| Solderability | 1Q/ 1/ 22/ 0 | JESD22-B102-B And CNS-5068 | Accelerated aging 155°C/ 24hrs Tinning speed: 2.5+0.5cm/s Tinning: A: 215°C/ 3+1s or B: 260°C/ 10+1s |
| Resistance to soldering heat | | CNS-5067 | Dipping soldering terminal only Soldering bath temperature A: 260+/-5°C; 10+/-1s B: 350+/-10°C; 3+/-0.5s |
| Operating life test | 1Q/ 1/ 40/ 0 | CNS-11829 | 1.) Precondition: 85°C baking for 24hrs 85°C/ 60%R.H. for 168hrs 2.) Tamb25°C; IF=20mA; duration 1000hrs |
| High humidity, high temperature bias | 1Q/ 1/ 45/ 0 | JESD-A101-B | Tamb: 85°C Humidity: 85% R.H., IF=5mA Duration: 1000hrs |
| High temperature bias | 1Q/ 1/ 20 | IN specs. | Tamb: 55°C IF=20mA Duration: 1000hrs |
| Pulse life test | 1Q/ 1/ 40/ 0 | | Tamb25°C, If=20mA,, Ip=100mA, Duty cycle=0.125 (tp=125 μs, T=1sec) Duration 500hrs) |
| Temperature cycle | 1Q/ 1/ 76/ 0 | JESD-A104-A IEC 68-2-14, Nb | A cycle: -40 degree C 15min; +85 degree C 15min Thermal steady within 5 min.. 300 cycles 2 chamber/ Air-to-air type |
| High humidity storage test | 1Q/ 1/ 40/ 0 | CNS-6117 | 60+3°C 90+5/-10% R.H. for 500hrs |
| High temperature storage test | 1Q/ 1/ 40/ 0 | CNS-554 | 100+10°C for 500hrs |
| Low temperature storage test | 1Q/ 1/ 40/ 0 | CNS-6118 | -40+5°C for 500hrs |

Revision History

| Changes since last revision | Page | Version No. | Revision Date |
|-----------------------------|------|-------------|---------------|
| Initial Release | | 1.0 | 07-10-2017 |
| | | | |
| | | | |
| | | | |
| | | | |
| | | | |
| | | | |
| | | | |
| | | | |

DISCLAIMER

INOLUX reserves the right to make changes without further notice to any products herein to improve reliability, function or design. INOLUX does not assume any liability arising out of the application or use of any product or circuit described herein; neither does it convey any license under its patent rights, nor the rights of others.

LIFE SUPPORT POLICY

INOLUX's products are not authorized for use as critical components in life support devices or systems without the express written approval of the President of INOLUX or INOLUX CORPORATION. As used herein:

1. Life support devices or systems are devices or systems which, (a) are intended for surgical implant into the body, or (b) support or sustain life, and (c) whose failure to perform when properly used in accordance with instructions for use provided in the labeling, can be reasonably expected to result in a significant injury of the user.
2. A critical component in any component of a life support device or system whose failure to perform can be reasonably expected to cause the failure of the life support device or system, or to affect its safety or effectiveness.