

ADR3412/ADR3420/ADR3425/ADR3430/ADR3433/ADR3440/ADR3450

FEATURES

Initial accuracy: $\pm 0.1\%$ (maximum)
Maximum temperature coefficient: 8 ppm/ $^{\circ}\text{C}$
Operating temperature range: -40°C to $+125^{\circ}\text{C}$
Output current: $+10\text{ mA}$ source/ -3 mA sink
Low quiescent current: 100 μA (maximum)
Low dropout voltage: 250 mV at 2 mA
Output noise (0.1 Hz to 10 Hz): $<10\text{ }\mu\text{V p-p}$ at 1.2 V (typical)
6-lead SOT-23

APPLICATIONS

Precision data acquisition systems
Industrial instrumentation
Medical devices
Battery-powered devices

GENERAL DESCRIPTION

The ADR3412/ADR3420/ADR3425/ADR3430/ADR3433/ADR3440/ADR3450 are low cost, low power, high precision CMOS voltage references, featuring $\pm 0.1\%$ initial accuracy, low operating current, and low output noise in a small SOT-23 package. For high accuracy, output voltage and temperature coefficient are trimmed digitally during final assembly using Analog Devices, Inc., proprietary DigiTrim[®] technology.

Stability and system reliability are further improved by the low output voltage hysteresis of the device and low long-term output voltage drift. Furthermore, the low operating current of the device (100 μA maximum) facilitates usage in low power devices, and its low output noise helps maintain signal integrity in critical signal processing systems.

These CMOS are available in a wide range of output voltages, all of which are specified over the industrial temperature range of -40°C to $+125^{\circ}\text{C}$.

Table 1. Selection Guide

| Model | Output Voltage (V) | Input Voltage Range (V) |
|---------|--------------------|-------------------------|
| ADR3412 | 1.200 | 2.3 to 5.5 |
| ADR3420 | 2.048 | 2.3 to 5.5 |
| ADR3425 | 2.500 | 2.7 to 5.5 |
| ADR3430 | 3.000 | 3.2 to 5.5 |
| ADR3433 | 3.300 | 3.5 to 5.5 |
| ADR3440 | 4.096 | 4.3 to 5.5 |
| ADR3450 | 5.000 | 5.2 to 5.5 |

PIN CONFIGURATION

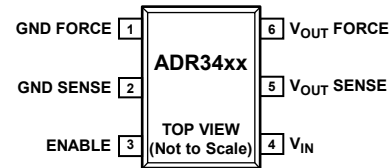

Figure 1. 6-Lead SOT-23

Table 2. Voltage Reference Choices from Analog Devices

| V _{OUT} (V) | Low Cost/ Low Power | Ultralow Power | Low Noise | High Voltage, High Performance |
|----------------------|-----------------------------|-------------------|------------------|-----------------------------------|
| 0.5/1.0 | | | ADR130 | |
| 1.2 | ADR3412 ADR280 | | | |
| 2.048 | ADR360 ADR3420 | REF191 | ADR430 ADR440 | |
| 2.5 | ADR3425 AD1582 ADR361 | ADR291 REF192 | ADR431 ADR441 | ADR03 AD780 |
| 3.0 | ADR3430 AD1583 ADR363 | REF193 | ADR433 ADR443 | ADR06 AD780 |
| 3.3 | ADR366 ADR3433 | REF196 | | |
| 4.096 | ADR3440 AD1584 ADR364 | ADR292 REF198 | ADR434 ADR444 | |
| 5.0 | ADR3450 AD1585 ADR365 | ADR293 REF195 | ADR435 ADR445 | ADR02 AD586 |
| 10.0 | | | | ADR01 AD587 |

TABLE OF CONTENTS

| | |
|---|----|
| Features | 1 |
| Applications..... | 1 |
| Pin Configuration..... | 1 |
| General Description | 1 |
| Revision History | 2 |
| Specifications..... | 3 |
| ADR3412 Electrical Characteristics..... | 3 |
| ADR3420 Electrical Characteristics..... | 4 |
| ADR3425 Electrical Characteristics..... | 5 |
| ADR3430 Electrical Characteristics..... | 6 |
| ADR3433 Electrical Characteristics..... | 7 |
| ADR3440 Electrical Characteristics..... | 8 |
| ADR3450 Electrical Characteristics..... | 9 |
| Absolute Maximum Ratings and Minimum Operating Condition..... | 10 |
| Thermal Resistance | 10 |
| ESD Caution..... | 10 |

REVISION HISTORY

6/2018—Rev. B to Rev. C

| | |
|--|----|
| Change to General Description | 1 |
| Change to Figure 17 | 14 |
| Change to Figure 23 | 15 |
| Changes to Figure 35 and Figure 36 Caption | 17 |
| Changes to Theory of Operation Section..... | 19 |
| Change to Ordering Guide..... | 22 |

6/2010—Rev. A to Rev. B

| | |
|--|------------|
| Added ADR3412, ADR3420, ADR3433 | Throughout |
| Changes to Table 1 and Table 2..... | 1 |
| Added ADR3412 Electrical Characteristics Section and Table 3..... | 3 |
| Added ADR3420 Electrical Characteristics Section and Table 4..... | 4 |
| Added ADR3433 Electrical Characteristics Section and Table 7, Renumbered Subsequent Tables | 7 |
| Replaced Figure 5 Through Figure 7..... | 12 |
| Replaced Figure 11 Through Figure 13 | 13 |

| | |
|--|----|
| Pin Configuration and Function Descriptions..... | 11 |
| Typical Performance Characteristics | 12 |
| Terminology | 18 |
| Theory of Operation | 19 |
| Long-Term Stability | 19 |
| Power Dissipation..... | 19 |
| Applications Information | 20 |
| Basic Voltage Reference Connection | 20 |
| Input and Output Capacitors..... | 20 |
| 4-Wire Kelvin Connections | 20 |
| V _{IN} Slew Rate Considerations..... | 20 |
| Shutdown/Enable Feature | 20 |
| Sample Applications..... | 21 |
| Outline Dimensions | 22 |
| Ordering Guide | 22 |

4/2010—Rev. 0 to Rev. A

| | |
|--|-----------|
| Added ADR3430 and ADR3440..... | Universal |
| Changes to Table 1, Table 2, and Figure 1 | 1 |
| Changes to Table 3..... | 3 |
| Added ADR3430 Electrical Characteristics Section..... | 4 |
| Added Table 4; Renumbered Sequentially | 4 |
| Added ADR3440 Electrical Characteristics Section and Table 5 | 5 |
| Changes to Table 6..... | 6 |
| Changes to Figure 2..... | 8 |
| Changes to Figure 4 and Figure 5..... | 9 |
| Changes to Figure 11..... | 10 |
| Changes to Figure 36 and Figure 37 Caption | 14 |
| Changes to Figure 39 and Theory of Operation Section | 16 |
| Changes to Figure 40 and Figure 41 | 17 |
| Changes to Negative Reference Section, Boosted Output Current Reference Section, Figure 43, and Figure 44..... | 18 |
| Changes to Ordering Guide | 19 |

3/2010—Revision 0: Initial Version

SPECIFICATIONS

ADR3412 ELECTRICAL CHARACTERISTICS

$V_{IN} = 2.3\text{ V to }5.5\text{ V}$, $T_A = 25^\circ\text{C}$, $I_{LOAD} = 0\text{ mA}$, unless otherwise noted.

Table 3.

| Parameter | Symbol | Conditions | Min | Typ | Max | Unit |
|--|----------------------------|--|----------------------|---------|------------------------|---|
| OUTPUT VOLTAGE | V_{OUT} | | 1.1988 | 1.2000 | 1.2012 | V |
| INITIAL ACCURACY | V_{OERR} | | | | ± 0.1 ± 1.2 | % mV |
| TEMPERATURE COEFFICIENT | TCV_{OUT} | $-40^\circ\text{C} \leq T_A \leq +125^\circ\text{C}$ | | | 8 | ppm/ $^\circ\text{C}$ |
| LINE REGULATION | $\Delta V_O/\Delta V_{IN}$ | $V_{IN} = 2.3\text{ V to }5.5\text{ V}$ $V_{IN} = 2.3\text{ V to }5.5\text{ V}, -40^\circ\text{C} \leq T_A \leq +125^\circ\text{C}$ | | 7 | 50 160 | ppm/V ppm/V |
| LOAD REGULATION | $\Delta V_O/\Delta I_L$ | $I_L = 0\text{ mA to }10\text{ mA},$ $V_{IN} = 2.8\text{ V}, -40^\circ\text{C} \leq T_A \leq +125^\circ\text{C}$ $I_L = 0\text{ mA to }-3\text{ mA},$ $V_{IN} = 2.8\text{ V}, -40^\circ\text{C} \leq T_A \leq +125^\circ\text{C}$ | | 14 7 | 30 50 | ppm/mA ppm/mA |
| OUTPUT CURRENT CAPACITY | I_L | $V_{IN} = 2.8\text{ V to }5.5\text{ V}$ $V_{IN} = 2.8\text{ V to }5.5\text{ V}$ | 10 -3 | | | mA mA |
| QUIESCENT CURRENT | I_Q | ENABLE $> V_{IN} \times 0.85$ ENABLE = V_{IN} , $-40^\circ\text{C} \leq T_A \leq +125^\circ\text{C}$ ENABLE $< 0.7\text{ V}$ | | | 85 100 5 | μA μA μA |
| DROPOUT VOLTAGE ¹ | V_{DO} | $I_L = 0\text{ mA}, -40^\circ\text{C} \leq T_A \leq +125^\circ\text{C}$ $I_L = 2\text{ mA}, -40^\circ\text{C} \leq T_A \leq +125^\circ\text{C}$ | | 1 1 | 1.1 1.15 | V V |
| ENABLE PIN | | | | | | |
| Shutdown Voltage | V_L | | 0 | | 0.7 | V |
| ENABLE Voltage | V_H | | $V_{IN} \times 0.85$ | | V_{IN} | V |
| ENABLE Pin Leakage Current | I_{EN} | ENABLE = V_{IN} , $-40^\circ\text{C} \leq T_A \leq +125^\circ\text{C}$ | | 0.85 | 3 | μA |
| OUTPUT VOLTAGE NOISE | e_n p-p | $f = 0.1\text{ Hz to }10\text{ Hz}$ $f = 10\text{ Hz to }10\text{ kHz}$ | | 8 28 | | $\mu\text{V p-p}$ $\mu\text{V rms}$ |
| OUTPUT VOLTAGE NOISE DENSITY | e_n | $f = 1\text{ kHz}$ | | 0.6 | | $\mu\text{V}/\sqrt{\text{Hz}}$ |
| OUTPUT VOLTAGE HYSTERESIS ² | ΔV_{OUT_HYS} | $T_A = +25^\circ\text{C to }-40^\circ\text{C to }+125^\circ\text{C to }+25^\circ\text{C}$ | | 70 | | ppm |
| RIPPLE REJECTION RATIO | RRR | $f_{IN} = 60\text{ Hz}$ | | -60 | | dB |
| LONG-TERM STABILITY | ΔV_{OUT_LTD} | 1000 hours at 50°C | | 30 | | ppm |
| TURN-ON SETTLING TIME | t_R | $C_{IN} = 0.1\ \mu\text{F}, C_L = 0.1\ \mu\text{F}, R_{Load} = 1\ \text{k}\Omega$ | | 100 | | μs |

¹ Refers to the minimum difference between V_{IN} and V_{OUT} such that V_{OUT} maintains a minimum accuracy of 0.1%. See the Terminology section.

² See the Terminology section. The part is placed through the temperature cycle in the order of temperatures shown.

ADR3412/ADR3420/ADR3425/ADR3430/ADR3433/ADR3440/ADR3450

ADR3420 ELECTRICAL CHARACTERISTICS

$V_{IN} = 2.3\text{ V to }5.5\text{ V}$, $T_A = 25^\circ\text{C}$, $I_{LOAD} = 0\text{ mA}$, unless otherwise noted.

Table 4.

| Parameter | Symbol | Conditions | Min | Typ | Max | Unit |
|---|----------------------------|--|----------------------|--------|--------------------------|--------------------------------|
| OUTPUT VOLTAGE | V_{OUT} | | 2.0459 | 2.0480 | 2.0500 | V |
| INITIAL ACCURACY | V_{OERR} | | | | ± 0.1 ± 2.048 | % mV |
| TEMPERATURE COEFFICIENT | TCV_{OUT} | $-40^\circ\text{C} \leq T_A \leq +125^\circ\text{C}$ | | | 8 | ppm/ $^\circ\text{C}$ |
| LINE REGULATION | $\Delta V_O/\Delta V_{IN}$ | $V_{IN} = 2.3\text{ V to }5.5\text{ V}$ $V_{IN} = 2.3\text{ V to }5.5\text{ V}, -40^\circ\text{C} \leq T_A \leq +125^\circ\text{C}$ | | 7 | 50 160 | ppm/V ppm/V |
| LOAD REGULATION | $\Delta V_O/\Delta I_L$ | | | | | |
| Sourcing | | $I_L = 0\text{ mA to }10\text{ mA},$ $V_{IN} = 2.8\text{ V}, -40^\circ\text{C} \leq T_A \leq +125^\circ\text{C}$ | | 12 | 30 | ppm/mA |
| Sinking | | $I_L = 0\text{ mA to }-3\text{ mA},$ $V_{IN} = 2.8\text{ V}, -40^\circ\text{C} \leq T_A \leq +125^\circ\text{C}$ | | 7 | 50 | ppm/mA |
| OUTPUT CURRENT CAPACITY | I_L | | | | | |
| Sourcing | | $V_{IN} = 2.8\text{ V to }5.5\text{ V}$ | 10 | | | mA |
| Sinking | | $V_{IN} = 2.8\text{ V to }5.5\text{ V}$ | -3 | | | mA |
| QUIESCENT CURRENT | I_Q | | | | | |
| Normal Operation | | ENABLE $> V_{IN} \times 0.85$ ENABLE = V_{IN} , $-40^\circ\text{C} \leq T_A \leq +125^\circ\text{C}$ | | | 85 100 | μA μA |
| Shutdown | | ENABLE $< 0.7\text{ V}$ | | | 5 | μA |
| DROPOUT VOLTAGE ¹ | V_{DO} | | | | | |
| $I_L = 0\text{ mA}, -40^\circ\text{C} \leq T_A \leq +125^\circ\text{C}$ | | | | 100 | 250 | mV |
| $I_L = 2\text{ mA}, -40^\circ\text{C} \leq T_A \leq +125^\circ\text{C}$ | | | | 150 | 300 | mV |
| ENABLE PIN | | | | | | |
| Shutdown Voltage | V_L | | 0 | | 0.7 | V |
| ENABLE Voltage | V_H | | $V_{IN} \times 0.85$ | | V_{IN} | V |
| ENABLE Pin Leakage Current | I_{EN} | ENABLE = V_{IN} , $-40^\circ\text{C} \leq T_A \leq +125^\circ\text{C}$ | | 0.85 | 3 | μA |
| OUTPUT VOLTAGE NOISE | e_n p-p | | | | | |
| $f = 0.1\text{ Hz to }10\text{ Hz}$ | | | | 15 | | $\mu\text{V p-p}$ |
| $f = 10\text{ Hz to }10\text{ kHz}$ | | | | 38 | | $\mu\text{V rms}$ |
| OUTPUT VOLTAGE NOISE DENSITY | e_n | $f = 1\text{ kHz}$ | | 0.9 | | $\mu\text{V}/\sqrt{\text{Hz}}$ |
| OUTPUT VOLTAGE HYSTERESIS ² | ΔV_{OUT_HYS} | $T_A = +25^\circ\text{C to }-40^\circ\text{C to }+125^\circ\text{C to }+25^\circ\text{C}$ | | 70 | | ppm |
| RIPPLE REJECTION RATIO | RRR | $f_{IN} = 60\text{ Hz}$ | | -60 | | dB |
| LONG-TERM STABILITY | ΔV_{OUT_LTD} | 1000 hours at 50°C | | 30 | | ppm |
| TURN-ON SETTLING TIME | t_R | $C_{IN} = 0.1\ \mu\text{F}, C_L = 0.1\ \mu\text{F}, R_{Load} = 1\ \text{k}\Omega$ | | 400 | | μs |

¹ Refers to the minimum difference between V_{IN} and V_{OUT} such that V_{OUT} maintains a minimum accuracy of 0.1%. See the Terminology section.

² See the Terminology section. The part is placed through the temperature cycle in the order of temperatures shown.

ADR3425 ELECTRICAL CHARACTERISTICS

$V_{IN} = 2.7\text{ V to }5.5\text{ V}$, $I_L = 0\text{ mA}$, $T_A = 25^\circ\text{C}$, unless otherwise noted.

Table 5.

| Parameter | Symbol | Conditions | Min | Typ | Max | Unit |
|--|----------------------------|--|----------------------|-------|------------------------|--------------------------------|
| OUTPUT VOLTAGE | V_{OUT} | | 2.4975 | 2.500 | 2.5025 | V |
| INITIAL ACCURACY | V_{OERR} | | | | ± 0.1 ± 2.5 | % mV |
| TEMPERATURE COEFFICIENT | TCV_{OUT} | $-40^\circ\text{C} \leq T_A \leq +125^\circ\text{C}$ | | 2.5 | 8 | ppm/ $^\circ\text{C}$ |
| LINE REGULATION | $\Delta V_O/\Delta V_{IN}$ | $V_{IN} = 2.7\text{ V to }5.5\text{ V}$ $V_{IN} = 2.7\text{ V to }5.5\text{ V}, -40^\circ\text{C} \leq T_A \leq +125^\circ\text{C}$ | | 5 | 50 120 | ppm/V ppm/V |
| LOAD REGULATION | $\Delta V_O/\Delta I_L$ | | | | | |
| Sourcing | | $I_L = 0\text{ mA to }10\text{ mA}$, $V_{IN} = 3.0\text{ V}, -40^\circ\text{C} \leq T_A \leq +125^\circ\text{C}$ | | 10 | 30 | ppm/mA |
| Sinking | | $I_L = 0\text{ mA to }-3\text{ mA}$, $V_{IN} = 3.0\text{ V}, -40^\circ\text{C} \leq T_A \leq +125^\circ\text{C}$ | | 10 | 50 | ppm/mA |
| OUTPUT CURRENT CAPACITY | I_L | | | | | |
| Sourcing | | $V_{IN} = 3.0\text{ V to }5.5\text{ V}$ | 10 | | | mA |
| Sinking | | $V_{IN} = 3.0\text{ V to }5.5\text{ V}$ | -3 | | | mA |
| QUIESCENT CURRENT | I_Q | | | | | |
| Normal Operation | | $ENABLE \geq V_{IN} \times 0.85$ $ENABLE = V_{IN}, -40^\circ\text{C} \leq T_A \leq +125^\circ\text{C}$ | | | 85 100 | μA μA |
| Shutdown | | $ENABLE \leq 0.7\text{ V}$ | | | 5 | μA |
| DROPOUT VOLTAGE ¹ | V_{DO} | | | | | |
| | | $I_L = 0\text{ mA}, T_A = -40^\circ\text{C} \leq T_A \leq +125^\circ\text{C}$ | | 50 | 200 | mV |
| | | $I_L = 2\text{ mA}, T_A = -40^\circ\text{C} \leq T_A \leq +125^\circ\text{C}$ | | 75 | 250 | mV |
| ENABLE PIN | | | | | | |
| Shutdown Voltage | V_L | | 0 | | 0.7 | V |
| ENABLE Voltage | V_H | | $V_{IN} \times 0.85$ | | V_{IN} | V |
| ENABLE Pin Leakage Current | I_{EN} | $ENABLE = V_{IN}, T_A = -40^\circ\text{C} \leq T_A \leq +125^\circ\text{C}$ | | 1 | 3 | μA |
| OUTPUT VOLTAGE NOISE | e_n p-p | | | | | |
| | | $f = 0.1\text{ Hz to }10\text{ Hz}$ | | 18 | | $\mu\text{V p-p}$ |
| | | $f = 10\text{ Hz to }10\text{ kHz}$ | | 42 | | $\mu\text{V rms}$ |
| OUTPUT VOLTAGE NOISE DENSITY | e_n | $f = 1\text{ kHz}$ | | 1 | | $\mu\text{V}/\sqrt{\text{Hz}}$ |
| OUTPUT VOLTAGE HYSTERESIS ² | ΔV_{OUT_HYS} | $T_A = +25^\circ\text{C to }-40^\circ\text{C to }+125^\circ\text{C to }+25^\circ\text{C}$ | | 70 | | ppm |
| RIPPLE REJECTION RATIO | RRR | $f_{IN} = 60\text{ Hz}$ | | -60 | | dB |
| LONG-TERM STABILITY | ΔV_{OUT_LTD} | 1000 hours at 50°C | | 30 | | ppm |
| TURN-ON SETTLING TIME | t_R | $C_{IN} = 0.1\ \mu\text{F}, C_L = 0.1\ \mu\text{F}, R_{Load} = 1\ \text{k}\Omega$ | | 600 | | μs |

¹ Refers to the minimum difference between V_{IN} and V_{OUT} such that V_{OUT} maintains a minimum accuracy of 0.1%. See the Terminology section.

² See the Terminology section. The part is placed through the temperature cycle in the order of temperatures shown.

ADR3412/ADR3420/ADR3425/ADR3430/ADR3433/ADR3440/ADR3450

ADR3430 ELECTRICAL CHARACTERISTICS

$V_{IN} = 3.2\text{ V to }5.5\text{ V}$, $I_L = 0\text{ mA}$, $T_A = 25^\circ\text{C}$, unless otherwise noted.

Table 6.

| Parameter | Symbol | Conditions | Min | Typ | Max | Unit |
|--|----------------------------|--|----------------------|----------|------------------------|--|
| OUTPUT VOLTAGE | V_{OUT} | | 2.9970 | 3.0000 | 3.0030 | V |
| INITIAL ACCURACY | V_{OERR} | | | | ± 0.1 ± 3.0 | % mV |
| TEMPERATURE COEFFICIENT | TCV_{OUT} | $-40^\circ\text{C} \leq T_A \leq +125^\circ\text{C}$ | | 2.5 | 8 | ppm/ $^\circ\text{C}$ |
| LINE REGULATION | $\Delta V_O/\Delta V_{IN}$ | $V_{IN} = 3.2\text{ V to }5.5\text{ V}$ $V_{IN} = 3.2\text{ V to }5.5\text{ V}, -40^\circ\text{C} \leq T_A \leq +125^\circ\text{C}$ | | 5 | 50 120 | ppm/V ppm/V |
| LOAD REGULATION | $\Delta V_O/\Delta I_L$ | | | | | |
| Sourcing | | $I_L = 0\text{ mA to }10\text{ mA}$, $V_{IN} = 3.5\text{ V}, -40^\circ\text{C} \leq T_A \leq +125^\circ\text{C}$ | | 9 | 30 | ppm/mA |
| Sinking | | $I_L = 0\text{ mA to }-3\text{ mA}$, $V_{IN} = 3.5\text{ V}, -40^\circ\text{C} \leq T_A \leq +125^\circ\text{C}$ | | 10 | 50 | ppm/mA |
| OUTPUT CURRENT CAPACITY | I_L | | | | | |
| Sourcing | | $V_{IN} = 3.5\text{ V to }5.5\text{ V}$ | 10 | | | mA |
| Sinking | | $V_{IN} = 3.5\text{ V to }5.5\text{ V}$ | -3 | | | mA |
| QUIESCENT CURRENT | I_Q | | | | | |
| Normal Operation | | ENABLE $\geq V_{IN} \times 0.85$ ENABLE = V_{IN} , $-40^\circ\text{C} \leq T_A \leq +125^\circ\text{C}$ | | | 85 100 | μA μA |
| Shutdown | | ENABLE $\leq 0.7\text{ V}$ | | | 5 | μA |
| DROPOUT VOLTAGE ¹ | V_{DO} | $I_L = 0\text{ mA}, T_A = -40^\circ\text{C} \leq T_A \leq +125^\circ\text{C}$ $I_L = 2\text{ mA}, T_A = -40^\circ\text{C} \leq T_A \leq +125^\circ\text{C}$ | | 50 75 | 200 250 | mV mV |
| ENABLE PIN | | | | | | |
| Shutdown Voltage | V_L | | 0 | | 0.7 | V |
| ENABLE Voltage | V_H | | $V_{IN} \times 0.85$ | | V_{IN} | V |
| ENABLE Pin Leakage Current | I_{EN} | ENABLE = V_{IN} , $T_A = -40^\circ\text{C} \leq T_A \leq +125^\circ\text{C}$ | | 0.85 | 3 | μA |
| OUTPUT VOLTAGE NOISE | e_n p-p | $f = 0.1\text{ Hz to }10\text{ Hz}$ $f = 10\text{ Hz to }10\text{ kHz}$ | | 22 45 | | $\mu\text{V p-p}$ $\mu\text{V rms}$ |
| OUTPUT VOLTAGE NOISE DENSITY | e_n | $f = 1\text{ kHz}$ | | 1.1 | | $\mu\text{V}/\sqrt{\text{Hz}}$ |
| OUTPUT VOLTAGE HYSTERESIS ² | ΔV_{OUT_HYS} | $T_A = +25^\circ\text{C to }-40^\circ\text{C to }+125^\circ\text{C to }+25^\circ\text{C}$ | | 70 | | ppm |
| RIPPLE REJECTION RATIO | RRR | $f_{IN} = 60\text{ Hz}$ | | -60 | | dB |
| LONG-TERM STABILITY | ΔV_{OUT_LTD} | 1000 hours at 50°C | | 30 | | ppm |
| TURN-ON SETTLING TIME | t_R | $C_{IN} = 0.1\ \mu\text{F}, C_L = 0.1\ \mu\text{F}, R_{Load} = 1\ \text{k}\Omega$ | | 700 | | μs |

¹ Refers to the minimum difference between V_{IN} and V_{OUT} such that V_{OUT} maintains a minimum accuracy of 0.1%. See the Terminology section.

² See the Terminology section. The part is placed through the temperature cycle in the order of temperatures shown.

ADR3433 ELECTRICAL CHARACTERISTICS

$V_{IN} = 3.5\text{ V to }5.5\text{ V}$, $I_L = 0\text{ mA}$, $T_A = 25^\circ\text{C}$, unless otherwise noted.

Table 7.

| Parameter | Symbol | Conditions | Min | Typ | Max | Unit |
|--|----------------------------|--|----------------------|----------|------------------------|--|
| OUTPUT VOLTAGE | V_{OUT} | | 3.2967 | 3.30 | 3.3033 | V |
| INITIAL ACCURACY | V_{OERR} | | | | ± 0.1 ± 3.3 | % mV |
| TEMPERATURE COEFFICIENT | TCV_{OUT} | $-40^\circ\text{C} \leq T_A \leq +125^\circ\text{C}$ | | | 8 | ppm/ $^\circ\text{C}$ |
| LINE REGULATION | $\Delta V_O/\Delta V_{IN}$ | $V_{IN} = 3.5\text{ V to }5.5\text{ V}$ $V_{IN} = 3.5\text{ V to }5.5\text{ V}, -40^\circ\text{C} \leq T_A \leq +125^\circ\text{C}$ | | 5 | 50 120 | ppm/V ppm/V |
| LOAD REGULATION | $\Delta V_O/\Delta I_L$ | | | | | |
| Sourcing | | $I_L = 0\text{ mA to }10\text{ mA}$, $V_{IN} = 3.8\text{ V}, -40^\circ\text{C} \leq T_A \leq +125^\circ\text{C}$ | | 9 | 30 | ppm/mA |
| Sinking | | $I_L = 0\text{ mA to }-3\text{ mA}$, $V_{IN} = 3.8\text{ V}, -40^\circ\text{C} \leq T_A \leq +125^\circ\text{C}$ | | 10 | 50 | ppm/mA |
| OUTPUT CURRENT CAPACITY | I_L | | | | | |
| Sourcing | | $V_{IN} = 3.8\text{ V to }5.5\text{ V}$ | 10 | | | mA |
| Sinking | | $V_{IN} = 3.8\text{ V to }5.5\text{ V}$ | -3 | | | mA |
| QUIESCENT CURRENT | I_Q | | | | | |
| Normal Operation | | ENABLE $> V_{IN} \times 0.85$ ENABLE = V_{IN} , $-40^\circ\text{C} \leq T_A \leq +125^\circ\text{C}$ | | | 85 100 | μA μA |
| Shutdown | | ENABLE $< 0.7\text{ V}$ | | | 5 | μA |
| DROPOUT VOLTAGE ¹ | V_{DO} | $I_L = 0\text{ mA}, -40^\circ\text{C} \leq T_A \leq +125^\circ\text{C}$ $I_L = 2\text{ mA}, -40^\circ\text{C} \leq T_A \leq +125^\circ\text{C}$ | | 50 75 | 200 250 | mV mV |
| ENABLE PIN | | | | | | |
| Shutdown Voltage | V_L | | 0 | | 0.7 | V |
| ENABLE Voltage | V_H | | $V_{IN} \times 0.85$ | | V_{IN} | V |
| ENABLE Pin Leakage Current | I_{EN} | ENABLE = V_{IN} , $-40^\circ\text{C} \leq T_A \leq +125^\circ\text{C}$ | | 0.85 | 3 | μA |
| OUTPUT VOLTAGE NOISE | e_n p-p | $f = 0.1\text{ Hz to }10\text{ Hz}$ $f = 10\text{ Hz to }10\text{ kHz}$ | | 25 46 | | $\mu\text{V p-p}$ $\mu\text{V rms}$ |
| OUTPUT VOLTAGE NOISE DENSITY | e_n | $f = 1\text{ kHz}$ | | 1.2 | | $\mu\text{V}/\sqrt{\text{Hz}}$ |
| OUTPUT VOLTAGE HYSTERESIS ² | ΔV_{OUT_HYS} | $T_A = +25^\circ\text{C to }-40^\circ\text{C to }+125^\circ\text{C to }+25^\circ\text{C}$ | | 70 | | ppm |
| RIPPLE REJECTION RATIO | RRR | $f_{IN} = 60\text{ Hz}$ | | -60 | | dB |
| LONG-TERM STABILITY | ΔV_{OUT_LTD} | 1000 hours at 50°C | | 30 | | ppm |
| TURN-ON SETTLING TIME | t_R | $C_{IN} = 0.1\ \mu\text{F}, C_L = 0.1\ \mu\text{F}, R_{Load} = 1\ \text{k}\Omega$ | | 750 | | μs |

¹ Refers to the minimum difference between V_{IN} and V_{OUT} such that V_{OUT} maintains a minimum accuracy of 0.1%. See the Terminology section.

² See the Terminology section. The part is placed through the temperature cycle in the order of temperatures shown.

ADR3412/ADR3420/ADR3425/ADR3430/ADR3433/ADR3440/ADR3450

ADR3440 ELECTRICAL CHARACTERISTICS

$V_{IN} = 4.3\text{ V to }5.5\text{ V}$, $I_L = 0\text{ mA}$, $T_A = 25^\circ\text{C}$, unless otherwise noted.

Table 8.

| Parameter | Symbol | Conditions | Min | Typ | Max | Unit |
|---|----------------------------|--|----------------------|--------|--------------------------|--------------------------------|
| OUTPUT VOLTAGE | V_{OUT} | | 4.0919 | 4.0960 | 4.1000 | V |
| INITIAL ACCURACY | V_{OERR} | | | | ± 0.1 ± 4.096 | % mV |
| TEMPERATURE COEFFICIENT | TCV_{OUT} | $-40^\circ\text{C} \leq T_A \leq +125^\circ\text{C}$ | | 2.5 | 8 | ppm/ $^\circ\text{C}$ |
| LINE REGULATION | $\Delta V_O/\Delta V_{IN}$ | $V_{IN} = 4.3\text{ V to }5.5\text{ V}$ $V_{IN} = 4.3\text{ V to }5.5\text{ V}, -40^\circ\text{C} \leq T_A \leq +125^\circ\text{C}$ | | 3 | 50 120 | ppm/V ppm/V |
| LOAD REGULATION | $\Delta V_O/\Delta I_L$ | | | | | |
| Sourcing | | $I_L = 0\text{ mA to }10\text{ mA}$, $V_{IN} = 4.6\text{ V}, -40^\circ\text{C} \leq T_A \leq +125^\circ\text{C}$ | | 6 | 30 | ppm/mA |
| Sinking | | $I_L = 0\text{ mA to }-3\text{ mA}$, $V_{IN} = 4.6\text{ V}, -40^\circ\text{C} \leq T_A \leq +125^\circ\text{C}$ | | 15 | 50 | ppm/mA |
| OUTPUT CURRENT CAPACITY | I_L | | | | | |
| Sourcing | | $V_{IN} = 4.6\text{ V to }5.5\text{ V}$ | 10 | | | mA |
| Sinking | | $V_{IN} = 4.6\text{ V to }5.5\text{ V}$ | -3 | | | mA |
| QUIESCENT CURRENT | I_Q | | | | | |
| Normal Operation | | $ENABLE \geq V_{IN} \times 0.85$ $ENABLE = V_{IN}, -40^\circ\text{C} \leq T_A \leq +125^\circ\text{C}$ | | | 85 100 | μA μA |
| Shutdown | | $ENABLE \leq 0.7\text{ V}$ | | | 5 | μA |
| DROPOUT VOLTAGE ¹ | V_{DO} | | | | | |
| $I_L = 0\text{ mA}, T_A = -40^\circ\text{C} \leq T_A \leq +125^\circ\text{C}$ | | | | 50 | 200 | mV |
| $I_L = 2\text{ mA}, T_A = -40^\circ\text{C} \leq T_A \leq +125^\circ\text{C}$ | | | | 75 | 250 | mV |
| ENABLE PIN | | | | | | |
| Shutdown Voltage | V_L | | 0 | | 0.7 | V |
| ENABLE Voltage | V_H | | $V_{IN} \times 0.85$ | | V_{IN} | V |
| ENABLE Pin Leakage Current | I_{EN} | $ENABLE = V_{IN}, T_A = -40^\circ\text{C} \leq T_A \leq +125^\circ\text{C}$ | | | 3 | μA |
| OUTPUT VOLTAGE NOISE | e_n p-p | | | | | |
| $f = 0.1\text{ Hz to }10\text{ Hz}$ | | | | 29 | | $\mu\text{V p-p}$ |
| $f = 10\text{ Hz to }10\text{ kHz}$ | | | | 53 | | $\mu\text{V rms}$ |
| OUTPUT VOLTAGE NOISE DENSITY | e_n | $f = 1\text{ kHz}$ | | 1.4 | | $\mu\text{V}/\sqrt{\text{Hz}}$ |
| OUTPUT VOLTAGE HYSTERESIS ² | ΔV_{OUT_HYS} | $T_A = +25^\circ\text{C to }-40^\circ\text{C to }+125^\circ\text{C to }+25^\circ\text{C}$ | | 70 | | ppm |
| RIPPLE REJECTION RATIO | RRR | $f_{IN} = 60\text{ Hz}$ | | -60 | | dB |
| LONG-TERM STABILITY | ΔV_{OUT_LTD} | 1000 hours at 50°C | | 30 | | ppm |
| TURN-ON SETTLING TIME | t_R | $C_{IN} = 0.1\ \mu\text{F}, C_L = 0.1\ \mu\text{F}, R_{Load} = 1\text{ k}\Omega$ | | 800 | | μs |

¹ Refers to the minimum difference between V_{IN} and V_{OUT} such that V_{OUT} maintains a minimum accuracy of 0.1%. See the Terminology section.

² See the Terminology section. The part is placed through the temperature cycle in the order of temperatures shown.

ADR3412/ADR3420/ADR3425/ADR3430/ADR3433/ADR3440/ADR3450

ADR3450 ELECTRICAL CHARACTERISTICS

$V_{IN} = 5.2\text{ V to }5.5\text{ V}$, $I_L = 0\text{ mA}$, $T_A = 25^\circ\text{C}$, unless otherwise noted.

Table 9.

| Parameter | Symbol | Conditions | Min | Typ | Max | Unit |
|--|----------------------------|--|----------------------|----------|------------------------|--|
| OUTPUT VOLTAGE | V_{OUT} | | 4.9950 | 5.0000 | 5.0050 | V |
| INITIAL ACCURACY | V_{OERR} | | | | ± 0.1 ± 5.0 | % mV |
| TEMPERATURE COEFFICIENT | TCV_{OUT} | $-40^\circ\text{C} \leq T_A \leq +125^\circ\text{C}$ | | 2.5 | 8 | ppm/ $^\circ\text{C}$ |
| LINE REGULATION | $\Delta V_O/\Delta V_{IN}$ | $V_{IN} = 5.2\text{ V to }5.5\text{ V}$ $V_{IN} = 5.2\text{ V to }5.5\text{ V}, -40^\circ\text{C} \leq T_A \leq +125^\circ\text{C}$ | | 3 | 50 120 | ppm/V ppm/V |
| LOAD REGULATION | $\Delta V_O/\Delta I_L$ | | | | | |
| Sourcing | | $I_L = 0\text{ mA to }10\text{ mA}$, $V_{IN} = 5.5\text{ V}, -40^\circ\text{C} \leq T_A \leq +125^\circ\text{C}$ | | 3 | 30 | ppm/mA |
| Sinking | | $I_L = 0\text{ mA to }-3\text{ mA}$, $V_{IN} = 5.5\text{ V}, -40^\circ\text{C} \leq T_A \leq +125^\circ\text{C}$ | | 19 | 50 | ppm/mA |
| OUTPUT CURRENT CAPACITY | I_L | | | | | |
| Sourcing | | $V_{IN} = 5.5\text{ V}$ | 10 | | | mA |
| Sinking | | $V_{IN} = 5.5\text{ V}$ | -3 | | | mA |
| QUIESCENT CURRENT | I_Q | | | | | |
| Normal Operation | | $ENABLE \geq V_{IN} \times 0.85$ $ENABLE = V_{IN}, -40^\circ\text{C} \leq T_A \leq +125^\circ\text{C}$ | | | 85 100 | μA μA |
| Shutdown | | $ENABLE \leq 0.7\text{ V}$ | | | 5 | μA |
| DROPOUT VOLTAGE ¹ | V_{DO} | | | | | |
| | | $I_L = 0\text{ mA}, T_A = -40^\circ\text{C} \leq T_A \leq +125^\circ\text{C}$ $I_L = 2\text{ mA}, T_A = -40^\circ\text{C} \leq T_A \leq +125^\circ\text{C}$ | | 50 75 | 200 250 | mV mV |
| ENABLE PIN | | | | | | |
| Shutdown Voltage | V_L | | 0 | | 0.7 | V |
| ENABLE Voltage | V_H | | $V_{IN} \times 0.85$ | | V_{IN} | V |
| ENABLE Pin Leakage Current | I_{EN} | $ENABLE = V_{IN}, T_A = -40^\circ\text{C} \leq T_A \leq +125^\circ\text{C}$ | | 1 | 3 | μA |
| OUTPUT VOLTAGE NOISE | e_n p-p | | | | | |
| | | $f = 0.1\text{ Hz to }10\text{ Hz}$ $f = 10\text{ Hz to }10\text{ kHz}$ | | 35 60 | | $\mu\text{V p-p}$ $\mu\text{V rms}$ |
| OUTPUT VOLTAGE NOISE DENSITY | e_n | $f = 1\text{ kHz}$ | | 1.5 | | $\mu\text{V}/\sqrt{\text{Hz}}$ |
| OUTPUT VOLTAGE HYSTERESIS ² | ΔV_{OUT_HYS} | $T_A = +25^\circ\text{C to }-40^\circ\text{C to }+125^\circ\text{C to }+25^\circ\text{C}$ | | 70 | | ppm |
| RIPPLE REJECTION RATIO | RRR | $f_{IN} = 60\text{ Hz}$ | | -58 | | dB |
| LONG-TERM STABILITY | ΔV_{OUT_LTD} | 1000 hours at 50°C | | 30 | | ppm |
| TURN-ON SETTLING TIME | t_R | $C_{IN} = 0.1\ \mu\text{F}, C_L = 0.1\ \mu\text{F}, R_{Load} = 1\ \text{k}\Omega$ | | 900 | | μs |

¹ Refers to the minimum difference between V_{IN} and V_{OUT} such that V_{OUT} maintains a minimum accuracy of 0.1%. See the Terminology section.

² See the Terminology section. The part is placed through the temperature cycle in the order of temperatures shown.

ABSOLUTE MAXIMUM RATINGS AND MINIMUM OPERATING CONDITION

T_A = 25°C, unless otherwise noted.

Table 10.

| Parameter | Rating |
|-----------------------------------|-----------------|
| Supply Voltage | 6 V |
| ENABLE to GND SENSE Voltage | V _{IN} |
| V _{IN} Minimum Slew Rate | 0.1 V/ms |
| Operating Temperature Range | -40°C to +125°C |
| Storage Temperature Range | -65°C to +125°C |
| Junction Temperature Range | -65°C to +150°C |

Stresses at or above those listed under Absolute Maximum Ratings may cause permanent damage to the product. This is a stress rating only; functional operation of the product at these or any other conditions above those indicated in the operational section of this specification is not implied. Operation beyond the maximum operating conditions for extended periods may affect product reliability.

THERMAL RESISTANCE

θ_{JA} is specified for the worst-case conditions, that is, a device soldered in a circuit board for surface-mount packages.

Table 11. Thermal Resistance

| Package Type | θ _{JA} | θ _{JC} | Unit |
|----------------------|-----------------|-----------------|------|
| 6-Lead SOT-23 (RJ-6) | 230 | 92 | °C/W |

ESD CAUTION

| | |
|---|---|
|  | <p>ESD (electrostatic discharge) sensitive device. Charged devices and circuit boards can discharge without detection. Although this product features patented or proprietary protection circuitry, damage may occur on devices subjected to high energy ESD. Therefore, proper ESD precautions should be taken to avoid performance degradation or loss of functionality.</p> |
|---|---|

PIN CONFIGURATION AND FUNCTION DESCRIPTIONS

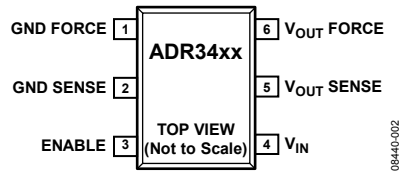

Figure 2. Pin Configuration

Table 12. Pin Function Descriptions

| Pin No. | Mnemonic | Description |
|---------|------------------------|--|
| 1 | GND FORCE | Ground Force Connection. ¹ |
| 2 | GND SENSE | Ground Voltage Sense Connection. Connect directly to the point of lowest potential in the application. ¹ |
| 3 | ENABLE | Enable Connection. Enables or disables the device. |
| 4 | V _{IN} | Input Voltage Connection. |
| 5 | V _{OUT} SENSE | Reference Voltage Output Sensing Connection. Connect directly to the voltage input of the load devices. ¹ |
| 6 | V _{OUT} FORCE | Reference Voltage Output. ¹ |

¹ See the Applications Information section for more information on force/sense connections.

TYPICAL PERFORMANCE CHARACTERISTICS

T_A = 25°C, unless otherwise noted.

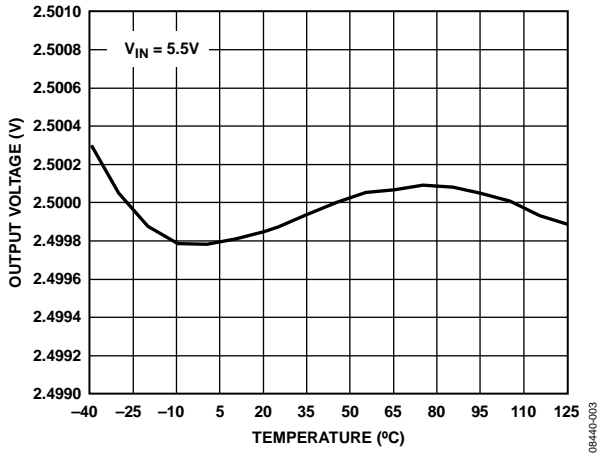

Figure 3. ADR3425 Output Voltage vs. Temperature

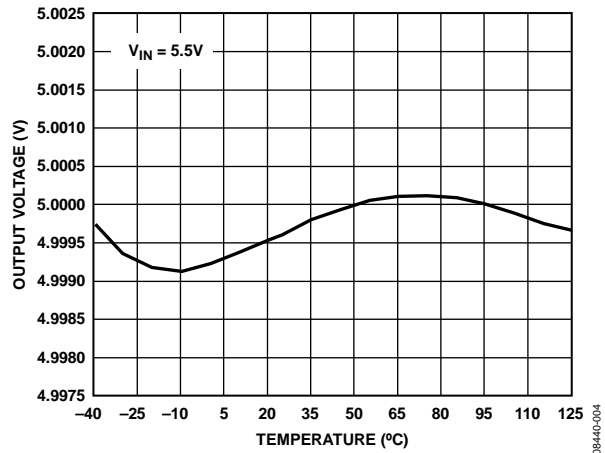

Figure 6. ADR3450 Output Voltage vs. Temperature

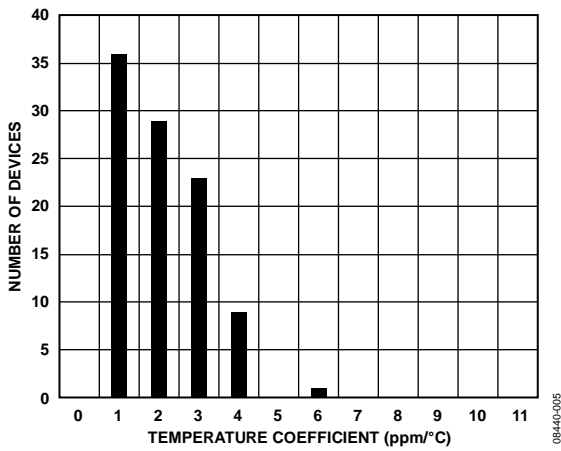

Figure 4. ADR3425 Temperature Coefficient Distribution

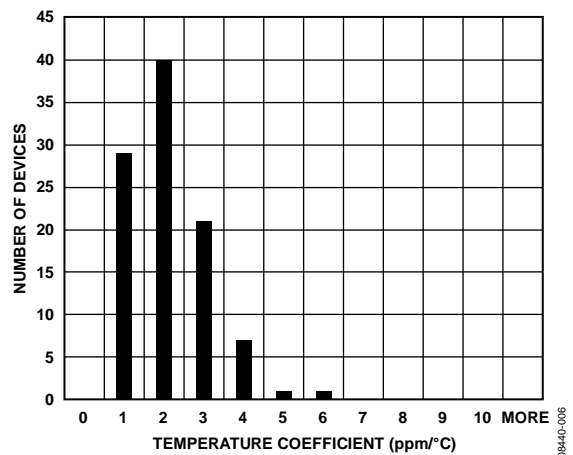

Figure 7. ADR3450 Temperature Coefficient Distribution

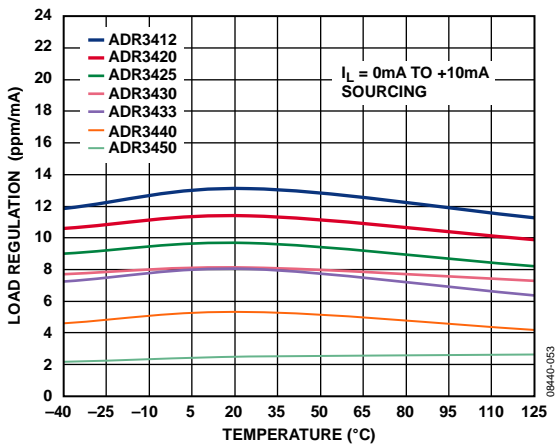

Figure 5. Load Regulation vs. Temperature (Sourcing)

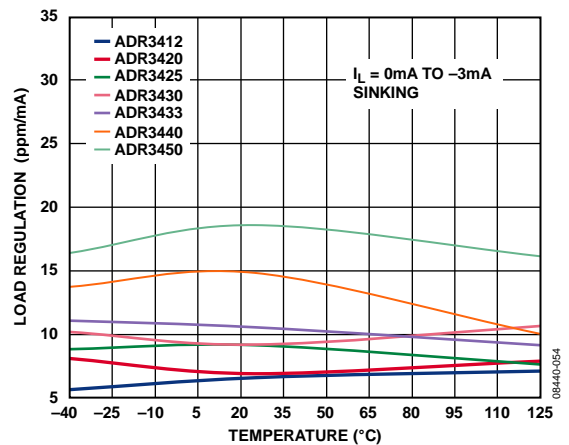

Figure 8. Load Regulation vs. Temperature (Sinking)

ADR3412/ADR3420/ADR3425/ADR3430/ADR3433/ADR3440/ADR3450

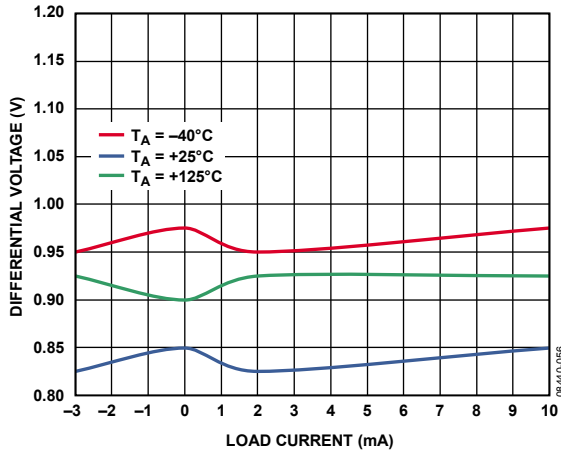

Figure 9. ADR3412 Dropout Voltage vs. Load Current

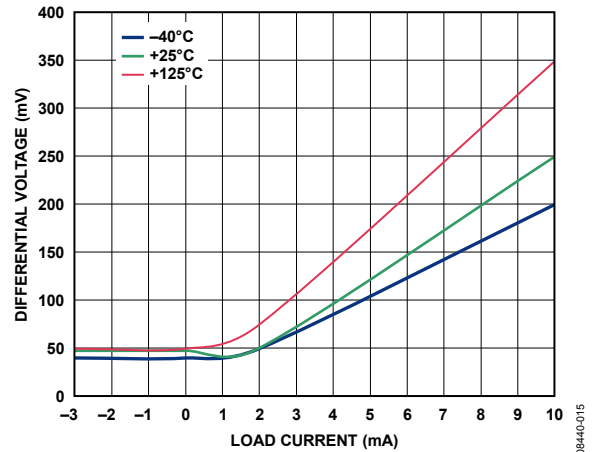

Figure 12. ADR3425 Dropout Voltage vs. Load Current

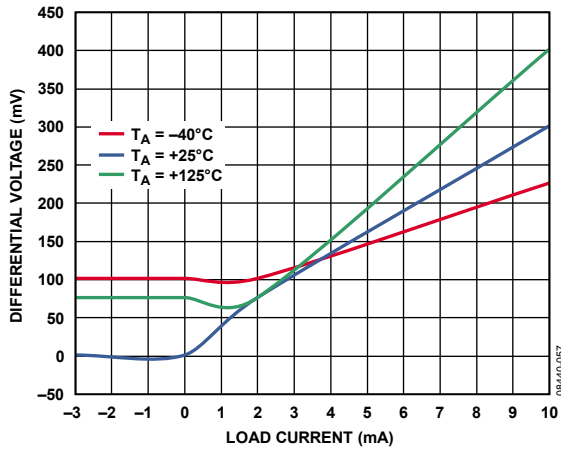

Figure 10. ADR3420 Dropout Voltage vs. Load Current

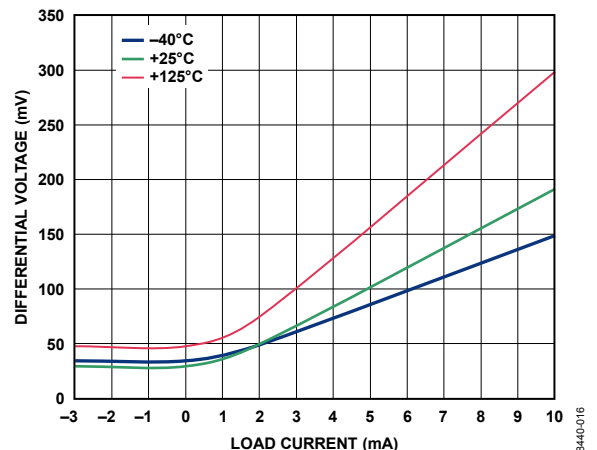

Figure 13. ADR3450 Dropout Voltage vs. Load Current

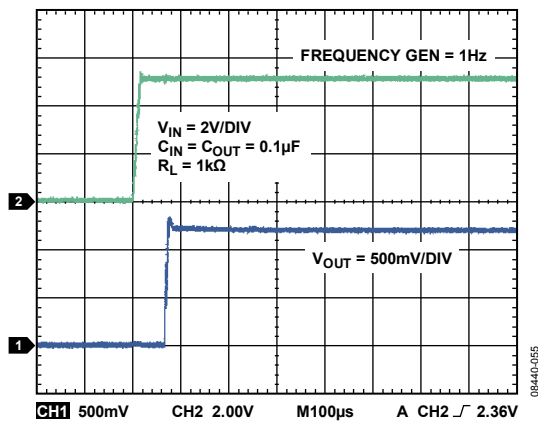

Figure 11. ADR3412 Start-Up (Turn-On Settle) Time

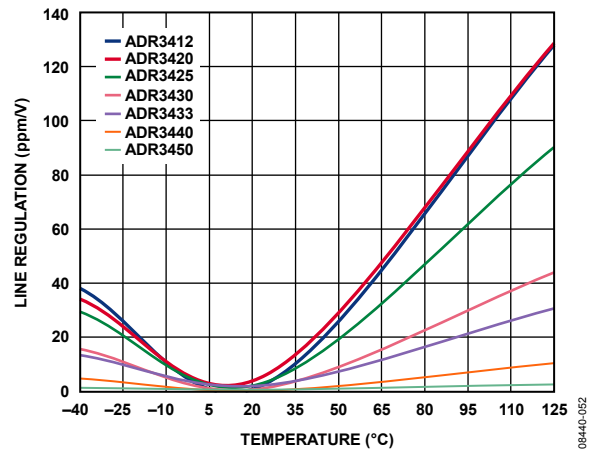

Figure 14. Line Regulation vs. Temperature

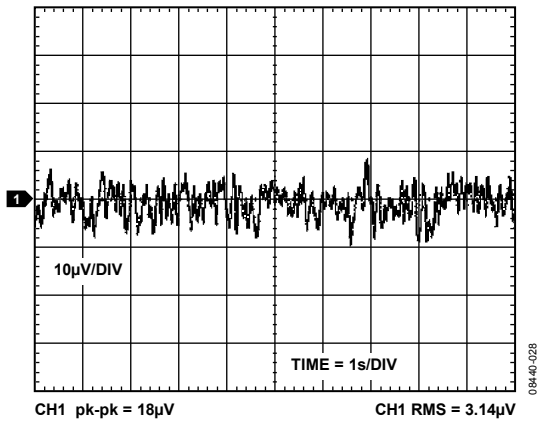

Figure 15. ADR3425 Output Voltage Noise (0.1 Hz to 10 Hz)

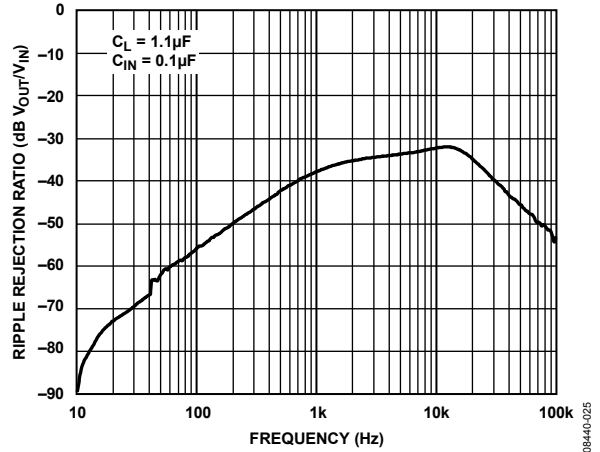

Figure 18. ADR3425 Ripple Rejection Ratio vs. Frequency

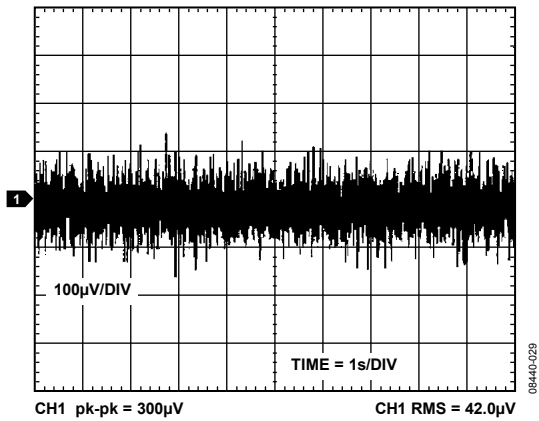

Figure 16. ADR3425 Output Voltage Noise (10 Hz to 10 kHz)

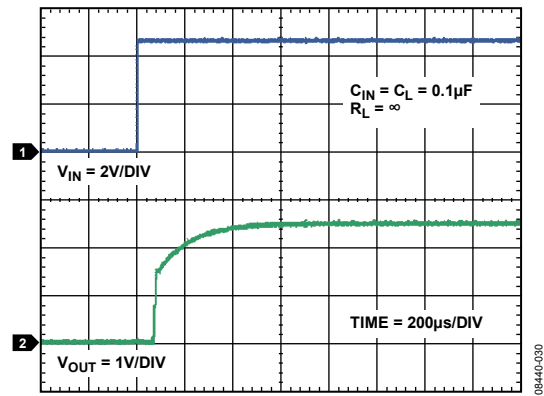

Figure 19. ADR3425 Start-Up Response

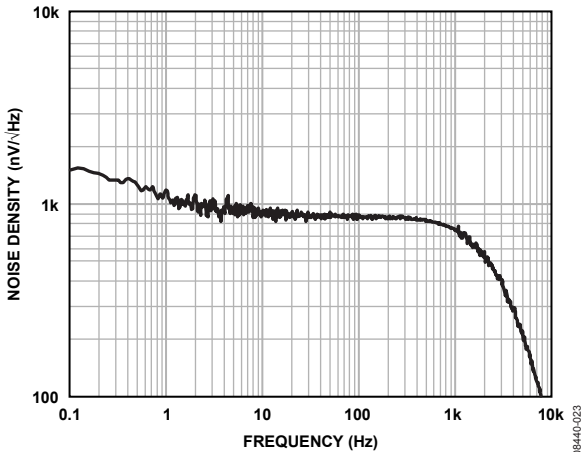

Figure 17. ADR3425 Output Noise Spectral Density

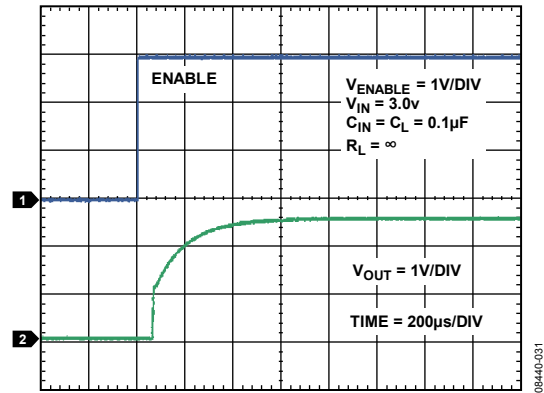

Figure 20. ADR3425 Restart Response from Shutdown

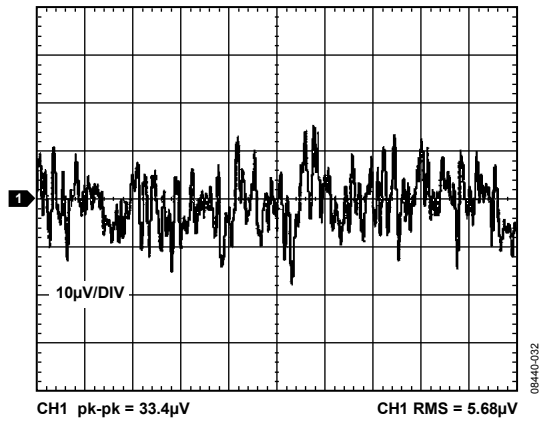

Figure 21. ADR3450 Output Voltage Noise (0.1 Hz to 10 Hz)

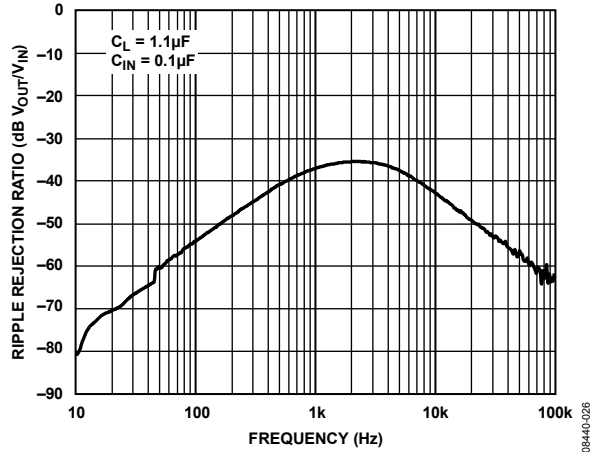

Figure 24. ADR3450 Ripple Rejection Ratio vs. Frequency

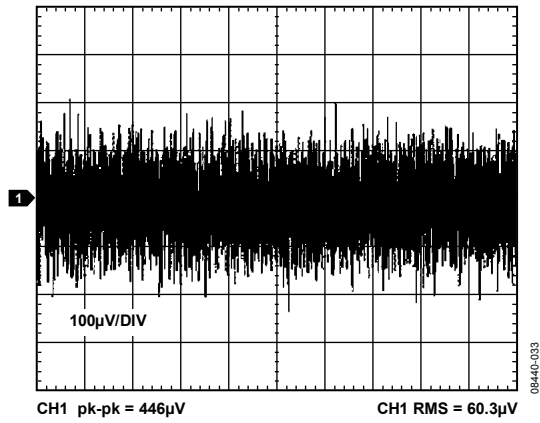

Figure 22. ADR3450 Output Voltage Noise (10 Hz to 10 kHz)

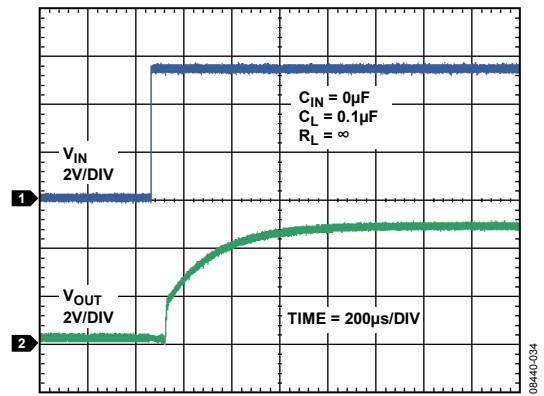

Figure 25. ADR3450 Start-Up Response

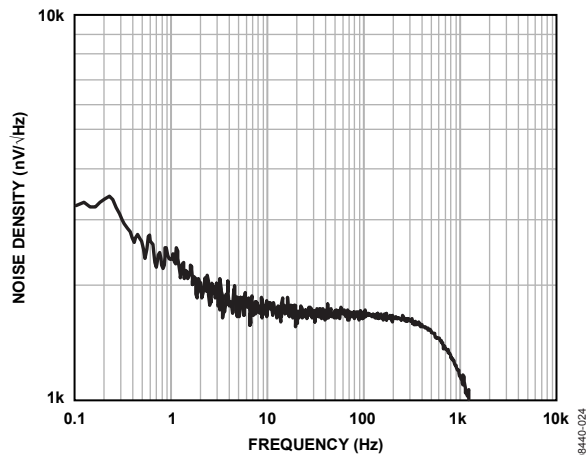

Figure 23. ADR3450 Output Noise Spectral Density

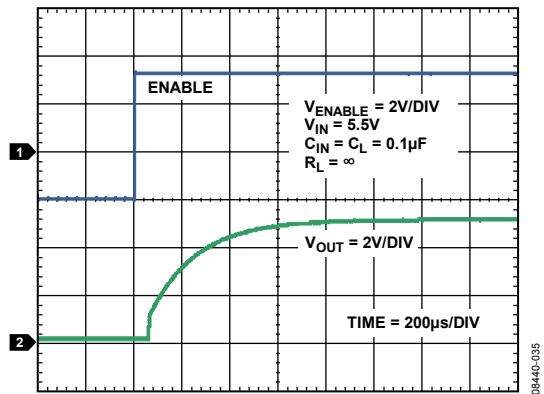

Figure 26. ADR3450 Restart Response from Shutdown

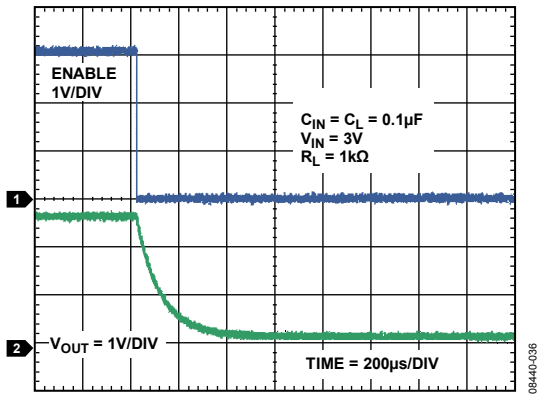

Figure 27. ADR3425 Shutdown Response

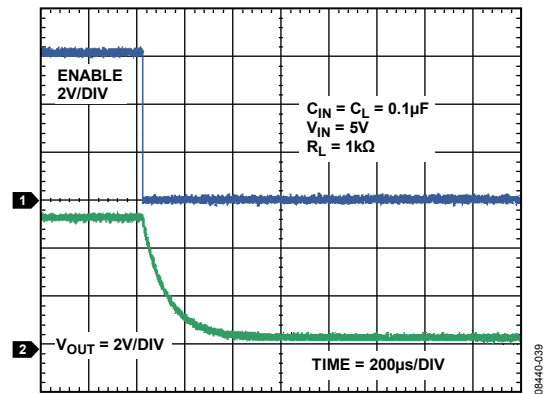

Figure 30. ADR3450 Shutdown Response

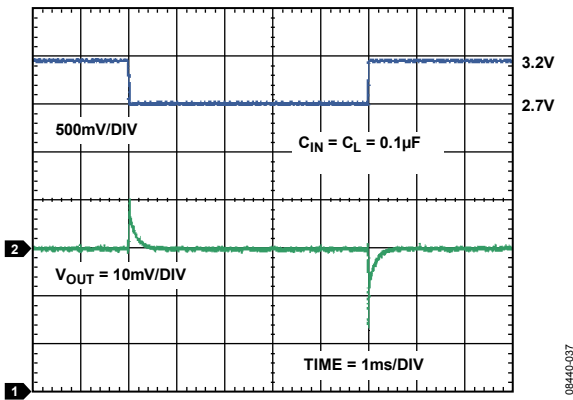

Figure 28. ADR3425 Line Transient Response

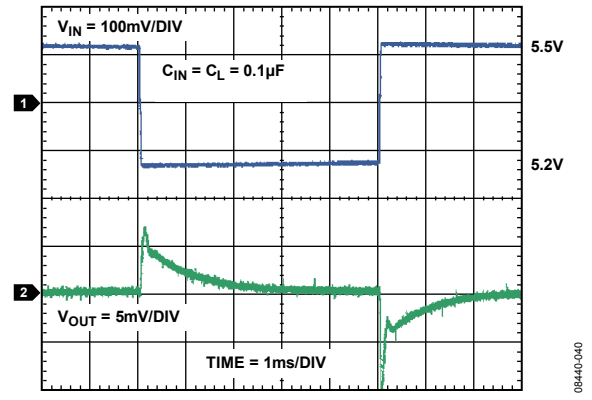

Figure 31. ADR3450 Line Transient Response

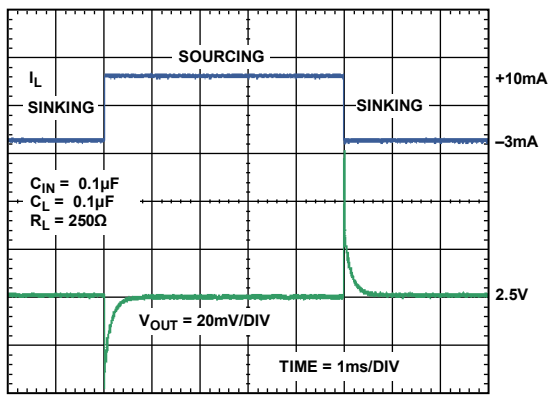

Figure 29. ADR3425 Load Transient Response

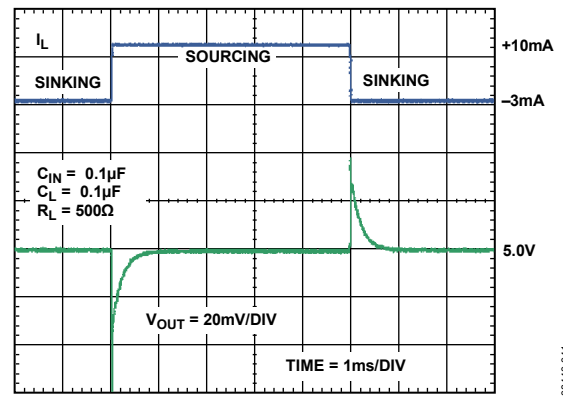

Figure 32. ADR3450 Load Transient Response

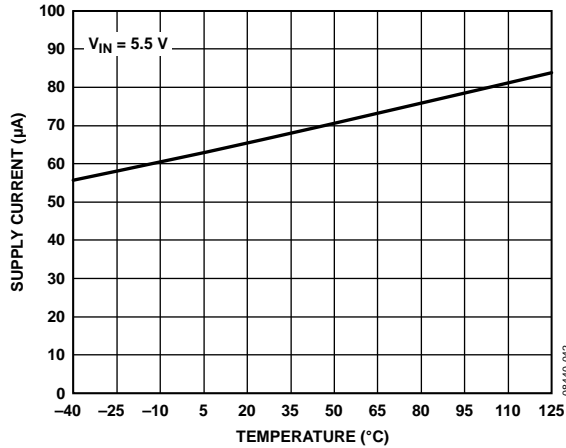

Figure 33. Supply Current vs. Temperature

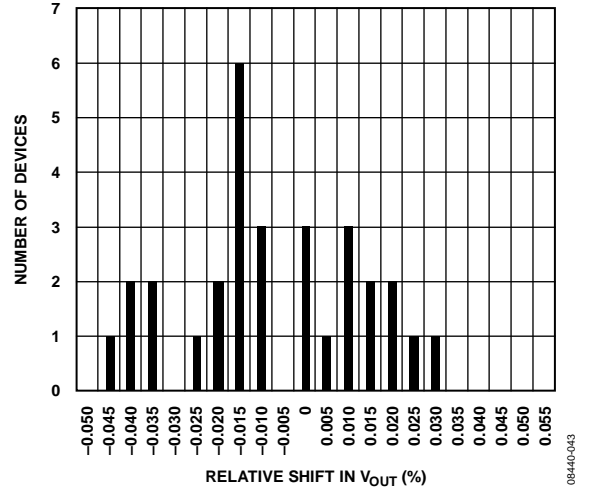

Figure 36. Output Voltage Shift Distribution After Reflow (SHR Drift)

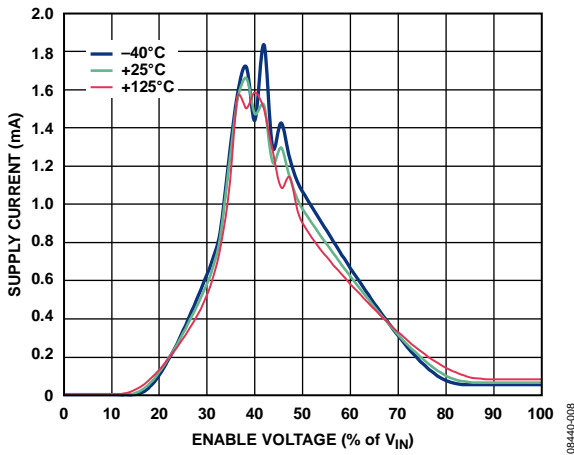

Figure 34. Supply Current vs. ENABLE Pin Voltage

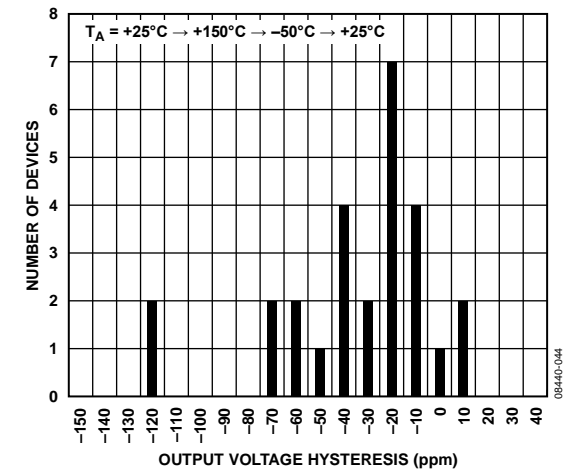

Figure 37. ADR3450 Thermally Induced Output Voltage Hysteresis Distribution

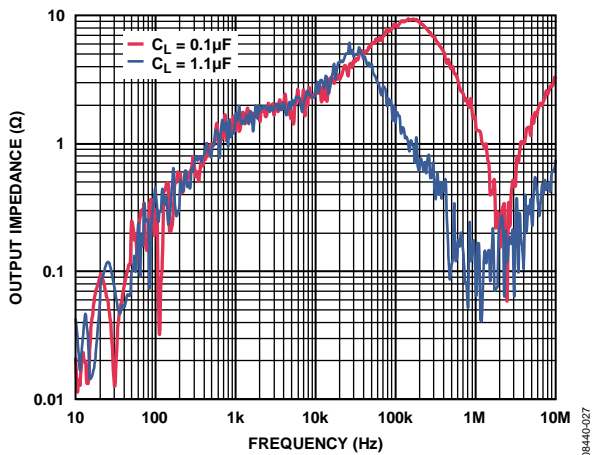

Figure 35. ADR3450 Output Impedance vs. Frequency

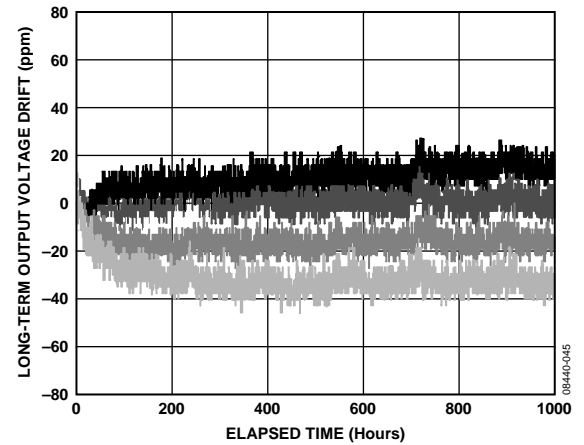

Figure 38. ADR3450 Typical Long-Term Output Voltage Drift (Four Devices, 1000 Hours)

TERMINOLOGY

Dropout Voltage (V_{DO})

Dropout voltage, sometimes referred to as supply voltage headroom or supply-output voltage differential, is defined as the minimum voltage differential between the input and output such that the output voltage is maintained to within 0.1% accuracy.

$$V_{DO} = (V_{IN} - V_{OUT})_{min} \mid I_L = constant$$

Because the dropout voltage depends upon the current passing through the device, it is always specified for a given load current. In series-mode devices, dropout voltage typically increases proportionally to load current (see Figure 8 and Figure 14).

Temperature Coefficient (TCV_{OUT})

The temperature coefficient relates the change in output voltage to the change in ambient temperature of the device, as normalized by the output voltage at 25°C. This parameter is expressed in ppm/°C and can be determined by the following equation:

$$TCV_{OUT} = \left| \frac{\max\{V_{OUT}(T_1, T_2, T_3)\} - \min\{V_{OUT}(T_1, T_2, T_3)\}}{V_{OUT}(T_2) \times (T_3 - T_1)} \right| \times 10^6 \text{ [ppm/°C]} \quad (1)$$

where:

$V_{OUT}(T)$ is the output voltage at Temperature T.

$T_1 = -40^\circ\text{C}$.

$T_2 = +25^\circ\text{C}$.

$T_3 = +125^\circ\text{C}$.

This three-point method ensures that TCV_{OUT} accurately portrays the maximum difference between any of the three temperatures at which the output voltage of the part is measured.

The TCV_{OUT} for the ADR3412/ADR3425/ADR3430/ADR3433/ADR3440/ADR3450 is guaranteed via statistical means. This is accomplished by recording output voltage data for a large number of units over temperature, computing TCV_{OUT} for each individual device via Equation 1, then defining the maximum TCV_{OUT} limits as the mean TCV_{OUT} for all devices extended by six standard deviations (6σ).

Thermally Induced Output Voltage Hysteresis (ΔV_{OUT_HYS})

Thermally induced output voltage hysteresis represents the change in output voltage after the device is exposed to a specified temperature cycle. This is expressed as either a shift in voltage or a difference in ppm from the nominal output.

$$\Delta V_{OUT_HYS} = V_{OUT}(25^\circ\text{C}) - V_{OUT_TC} \text{ [V]}$$

$$\Delta V_{OUT_HYS} = \frac{V_{OUT}(25^\circ\text{C}) - V_{OUT_TC}}{V_{OUT}(25^\circ\text{C})} \times 10^6 \text{ [ppm]}$$

where:

$V_{OUT}(25^\circ\text{C})$ is the output voltage at 25°C.

V_{OUT_TC} is the output voltage after temperature cycling.

Long-Term Stability (ΔV_{OUT_LTD})

Long-term stability refers to the shift in output voltage at 50°C after 1000 hours of operation in a 50°C environment. Ambient temperature is kept at 50°C to ensure that the temperature chamber does not switch randomly between heating and cooling, which can cause instability over the 1000 hour measurement. This is also expressed as either a shift in voltage or a difference in ppm from the nominal output.

$$\Delta V_{OUT_LTD} = |V_{OUT}(t_1) - V_{OUT}(t_0)| \text{ [V]}$$

$$\Delta V_{OUT_LTD} = \left| \frac{V_{OUT}(t_1) - V_{OUT}(t_0)}{V_{OUT}(t_0)} \right| \times 10^6 \text{ [ppm]}$$

where:

$V_{OUT}(t_0)$ is the V_{OUT} at 50°C at Time 0.

$V_{OUT}(t_1)$ is the V_{OUT} at 50°C after 1000 hours of operation at 50°C.

Line Regulation

Line regulation refers to the change in output voltage in response to a given change in input voltage and is expressed in percent per volt, ppm per volt, or μV per volt change in input voltage. This parameter accounts for the effects of self-heating.

Load Regulation

Load regulation refers to the change in output voltage in response to a given change in load current and is expressed in μV per mA, ppm per mA, or ohms of dc output resistance. This parameter accounts for the effects of self-heating.

Solder Heat Resistance (SHR) Drift

SHR drift refers to the permanent shift in output voltage induced by exposure to reflow soldering, expressed in units of ppm. This is caused by changes in the stress exhibited upon the die by the package materials when exposed to high temperatures. This effect is more pronounced in lead-free soldering processes due to higher reflow temperatures.

THEORY OF OPERATION

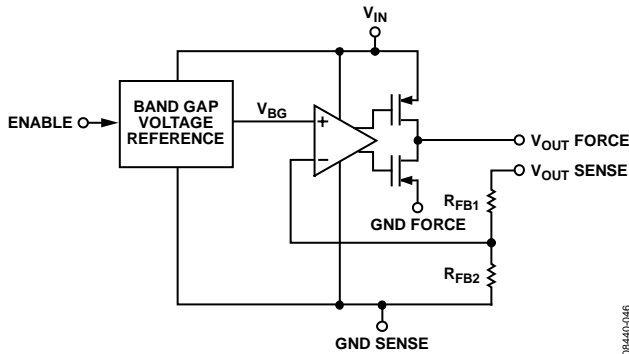

Figure 39. Block Diagram

The ADR3412/ADR3425/ADR3430/ADR3433/ADR3440/ADR3450 use a proprietary voltage reference architecture to achieve high accuracy, low temperature coefficient (TC), and low noise in a CMOS process. Like all band gap references, the references combine two voltages of opposite TCs to create an output voltage that is nearly independent of ambient temperature. However, unlike traditional band gap voltage references, the temperature-independent voltage of the references is arranged to be the base-emitter voltage, V_{BE} , of a bipolar transistor at room temperature rather than the V_{BE} extrapolated to 0 K (the V_{BE} of bipolar transistor at 0 K is approximately V_{GO} , the band gap voltage of silicon). A corresponding positive-TC voltage is then added to the V_{BE} voltage to compensate for its negative TC.

The key benefit of this technique is that the trimming of the initial accuracy and TC can be performed without interfering with one another, thereby increasing overall accuracy across temperature. Curvature correction techniques further reduce the temperature variation.

The band gap voltage (V_{BG}) is then buffered and amplified to produce stable output voltages of 2.5 V and 5.0 V. The output buffer can source up to 10 mA and sink up to -3 mA of load current.

The ADR34xx family leverages Analog Devices proprietary DigiTrim technology to achieve high initial accuracy and low TC, and precision layout techniques lead to very low long-term drift and thermal hysteresis.

LONG-TERM STABILITY

One of the key parameters of the ADR34xx references is long-term stability. Regardless of output voltage, internal testing during development showed a typical drift of approximately 30 ppm after 1000 hours of continuous, nonloaded operation in a 50°C environment.

It is important to understand that long-term stability is not guaranteed by design and that the output from the device may shift beyond the typical 30 ppm specification at any time, especially during the first 200 hours of operation. For systems that require highly stable output voltages over long periods of time, the designer should consider burning in the devices prior to use to minimize the amount of output drift exhibited by the reference over time. See the AN-713 Application Note, *The Effect of Long-Term Drift on Voltage References*, at www.analog.com for more information regarding the effects of long-term drift and how it can be minimized.

POWER DISSIPATION

The ADR34xx voltage references are capable of sourcing up to 10 mA of load current at room temperature across the rated input voltage range. However, when used in applications subject to high ambient temperatures, the input voltage and load current should be carefully monitored to ensure that the device does not exceed its maximum power dissipation rating. The maximum power dissipation of the device can be calculated via the following equation:

$$P_D = \frac{T_J - T_A}{\theta_{JA}} [W]$$

where:

P_D is the device power dissipation.

T_J is the device junction temperature.

T_A is the ambient temperature.

θ_{JA} is the package (junction-to-air) thermal resistance.

Because of this relationship, acceptable load current in high temperature conditions may be less than the maximum current-sourcing capability of the device. In no case should the part be operated outside of its maximum power rating because doing so can result in premature failure or permanent damage to the device.

APPLICATIONS INFORMATION

BASIC VOLTAGE REFERENCE CONNECTION

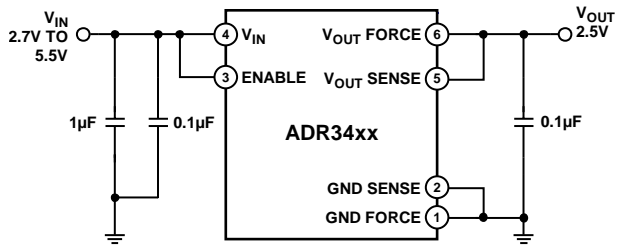

Figure 40. Basic Reference Connection

The circuit shown in Figure 40 illustrates the basic configuration for the ADR34xx references. Bypass capacitors should be connected according to the following guidelines.

INPUT AND OUTPUT CAPACITORS

A 1 µF to 10 µF electrolytic or ceramic capacitor can be connected to the input to improve transient response in applications where the supply voltage may fluctuate. An additional 0.1 µF ceramic capacitor should be connected in parallel to reduce high frequency supply noise.

A ceramic capacitor of at least a 0.1 µF must be connected to the output to improve stability and help filter out high frequency noise. An additional 1 µF to 10 µF electrolytic or ceramic capacitor can be added in parallel to improve transient performance in response to sudden changes in load current; however, the designer should keep in mind that doing so increases the turn-on time of the device.

Best performance and stability is attained with low ESR (for example, less than 1 Ω), low inductance ceramic chip-type output capacitors (X5R, X7R, or similar). If using an electrolytic capacitor on the output, a 0.1 µF ceramic capacitor should be placed in parallel to reduce overall ESR on the output.

4-WIRE KELVIN CONNECTIONS

Current flowing through a PCB trace produces an IR voltage drop, and with longer traces, this drop can reach several millivolts or more, introducing a considerable error into the output voltage of the reference. A 1 inch long, 5 mm wide trace of 1 ounce copper has a resistance of approximately 100 mΩ at room temperature; at a load current of 10 mA, this can introduce a full millivolt of error. In an ideal board layout, the reference should be mounted as close to the load as possible to minimize the length of the output traces, and, therefore, the error introduced by voltage drop. However, in applications where this is not possible or convenient, force and sense connections (sometimes referred to as Kelvin sensing connections) are provided as a means of minimizing the IR drop and improving accuracy.

Kelvin connections work by providing a set of high impedance voltage-sensing lines to the output and ground nodes. Because very little current flows through these connections, the IR drop across their traces is negligible, and the output and ground

voltages can be sensed accurately. These voltages are fed back into the internal amplifier and used to automatically correct for the voltage drop across the current-carrying output and ground lines, resulting in a highly accurate output voltage across the load. To achieve the best performance, the sense connections should be connected directly to the point in the load where the output voltage should be the most accurate. See Figure 41 for an example application.

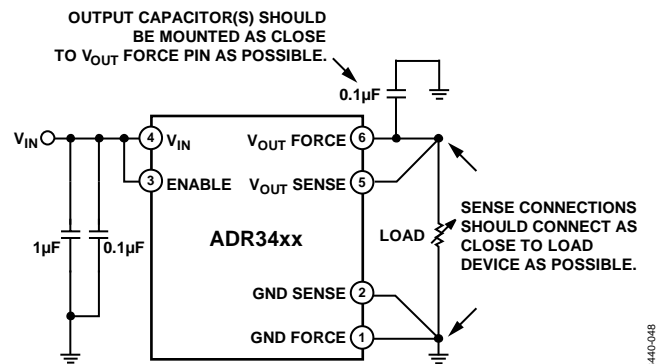

Figure 41. Application Showing Kelvin Connection

It is always advantageous to use Kelvin connections whenever possible. However, in applications where the IR drop is negligible or an extra set of traces cannot be routed to the load, the force and sense pins for both V_{OUT} and GND can simply be tied together, and the device can be used in the same fashion as a normal 3-terminal reference (as shown in Figure 40).

V_{IN} SLEW RATE CONSIDERATIONS

In applications with slow-rising input voltage signals, the reference exhibits overshoot or other transient anomalies that appear on the output. These phenomena also appear during shutdown as the internal circuitry loses power.

To avoid such conditions, ensure that the input voltage waveform has both a rising and falling slew rate of at least 0.1 V/ms.

SHUTDOWN/ENABLE FEATURE

The ADR34xx references can be switched to a low power shutdown mode when a voltage of 0.7 V or lower is input to the ENABLE pin. Likewise, the reference becomes operational for ENABLE voltages of $0.85 \times V_{IN}$ or higher. During shutdown, the supply current drops to less than 5 µA, useful in applications that are sensitive to power consumption.

If using the shutdown feature, ensure that the ENABLE pin voltage does not fall between 0.7 V and $0.85 \times V_{IN}$ because this causes a large increase in the supply current of the device and may keep the reference from starting up correctly (see Figure 34). If not using the shutdown feature, however, the ENABLE pin can simply be tied to the V_{IN} pin, and the reference remains operational continuously.

SAMPLE APPLICATIONS

Negative Reference

Figure 42 shows how to connect the ADR3450 and a standard CMOS op amp, such as the AD8663, to provide a negative reference voltage. This configuration provides two main advantages: first, it only requires two devices and, therefore, does not require excessive board space; second, and more importantly, it does not require any external resistors, meaning that the performance of this circuit does not rely on choosing expensive parts with low temperature coefficients to ensure accuracy.

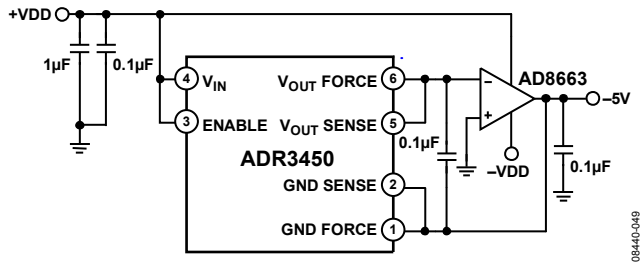

Figure 42. ADR3450 Negative Reference

In this configuration, the V_{OUT} pins of the reference sit at virtual ground, and the negative reference voltage and load current are taken directly from the output of the operational amplifier. Note that in applications where the negative supply voltage is close to the reference output voltage, a dual-supply, low offset, rail-to-rail output amplifier must be used to ensure an accurate output voltage. The operational amplifier must also be able to source or sink an appropriate amount of current for the application.

Bipolar Output Reference

Figure 43 shows a bipolar reference configuration. By connecting the output of the ADR3450 to the inverting terminal of an operational amplifier, it is possible to obtain both positive and negative reference voltages. R1 and R2 must be matched as closely as possible to ensure minimal difference between the negative and positive outputs. Resistors with low temperature coefficients must also be used if the circuit is used in environments with large temperature swings; otherwise, a voltage difference develops between the two outputs as the ambient temperature changes.

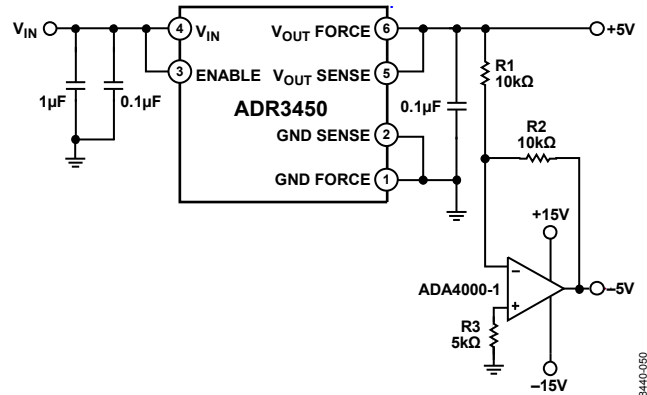

Figure 43. ADR3450 Bipolar Output Reference

Boosted Output Current Reference

Figure 44 shows a configuration for obtaining higher current drive capability from the ADR34xx references without sacrificing accuracy. The op amp regulates the current flow through the MOSFET until V_{OUT} equals the output voltage of the reference; current is then drawn directly from V_{IN} instead of from the reference itself, allowing increased current drive capability.

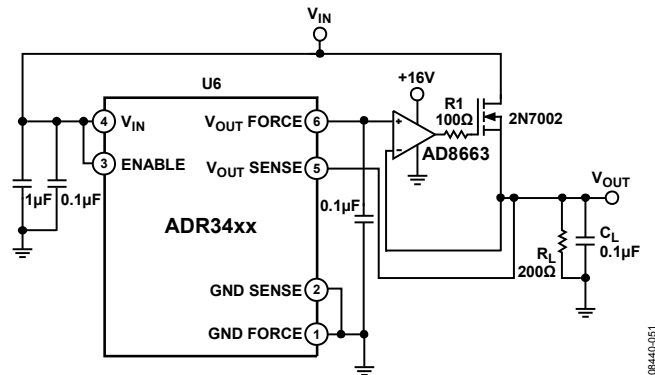
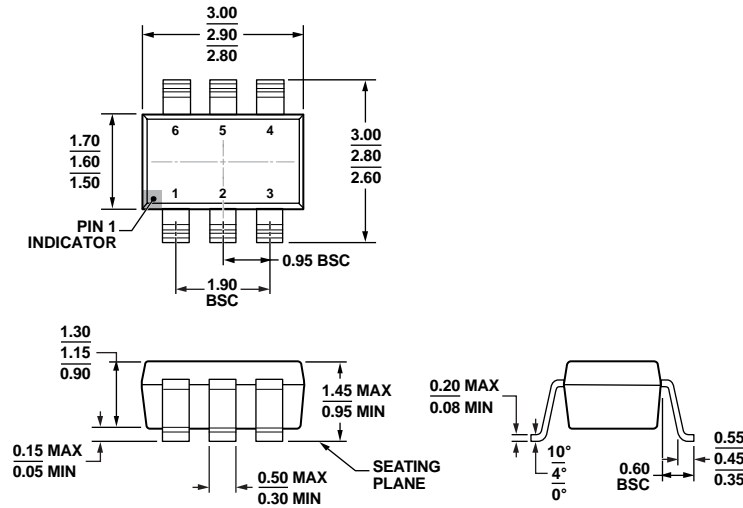

Figure 44. Boosted Output Current Reference

Because the current-sourcing capability of this circuit depends only on the I_D rating of the MOSFET, the output drive capability can be adjusted to the application simply by choosing an appropriate MOSFET. In all cases, the V_{OUT} SENSE pin should be tied directly to the load device to maintain maximum output voltage accuracy.

OUTLINE DIMENSIONS



COMPLIANT TO JEDEC STANDARDS MO-178-AB

Figure 45. 6-Lead Small Outline Transistor Package (SOT-23) (RJ-6)

Dimensions shown in millimeters

12-16-2008-A

ORDERING GUIDE

| Model ¹ | Output Voltage (V) | Temperature Range | Package Description | Package Option | Ordering Quantity | Marking Code |
|--------------------|--------------------|-------------------|---------------------|----------------|-------------------|--------------|
| ADR3412ARJZ-R2 | 1.200 | -40°C to +125°C | 6-Lead SOT-23 | RJ-6 | 250 | R2R |
| ADR3412ARJZ-R7 | 1.200 | -40°C to +125°C | 6-Lead SOT-23 | RJ-6 | 3,000 | R2R |
| ADR3420ARJZ-R2 | 2.048 | -40°C to +125°C | 6-Lead SOT-23 | RJ-6 | 250 | R2V |
| ADR3420ARJZ-R7 | 2.048 | -40°C to +125°C | 6-Lead SOT-23 | RJ-6 | 3,000 | R2V |
| ADR3425ARJZ-R2 | 2.500 | -40°C to +125°C | 6-Lead SOT-23 | RJ-6 | 250 | R2X |
| ADR3425ARJZ-R7 | 2.500 | -40°C to +125°C | 6-Lead SOT-23 | RJ-6 | 3,000 | R2X |
| ADR3430ARJZ-R2 | 3.000 | -40°C to +125°C | 6-Lead SOT-23 | RJ-6 | 250 | R2Z |
| ADR3430ARJZ-R7 | 3.000 | -40°C to +125°C | 6-Lead SOT-23 | RJ-6 | 3,000 | R2Z |
| ADR3433ARJZ-R2 | 3.300 | -40°C to +125°C | 6-Lead SOT-23 | RJ-6 | 250 | R31 |
| ADR3433ARJZ-R7 | 3.300 | -40°C to +125°C | 6-Lead SOT-23 | RJ-6 | 3,000 | R31 |
| ADR3440ARJZ-R2 | 4.096 | -40°C to +125°C | 6-Lead SOT-23 | RJ-6 | 250 | R33 |
| ADR3440ARJZ-R7 | 4.096 | -40°C to +125°C | 6-Lead SOT-23 | RJ-6 | 3,000 | R33 |
| ADR3450ARJZ-R2 | 5.000 | -40°C to +125°C | 6-Lead SOT-23 | RJ-6 | 250 | R34 |
| ADR3450ARJZ-R7 | 5.000 | -40°C to +125°C | 6-Lead SOT-23 | RJ-6 | 3,000 | R34 |

¹ Z = RoHS Compliant Part.