

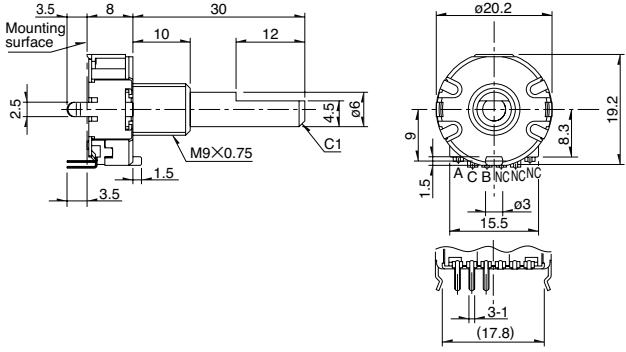

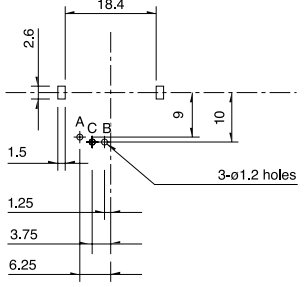

Dimensions

Unit:mm

| No. | Photo   | Style   | PC board mounting hole dimensions<br>(View from mounting side)                        |
|-----|---|---|---|
| 2   |    |   |    |
| 3   |  |  |  |

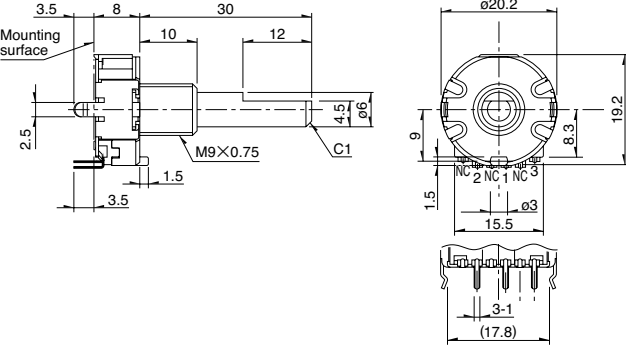
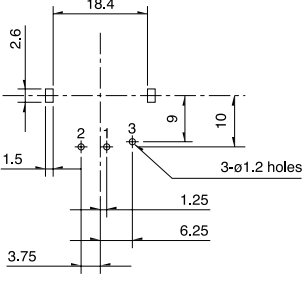
Output Wave (EC20A)

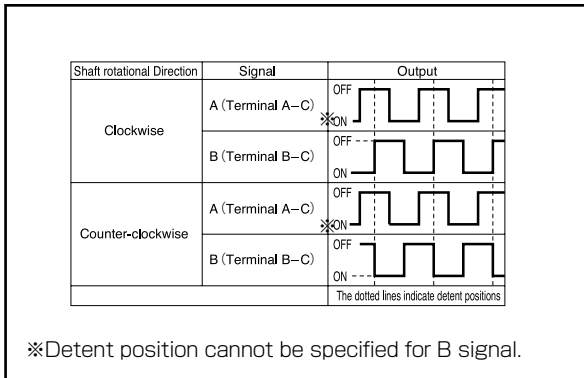

Output Wave (EC20A)

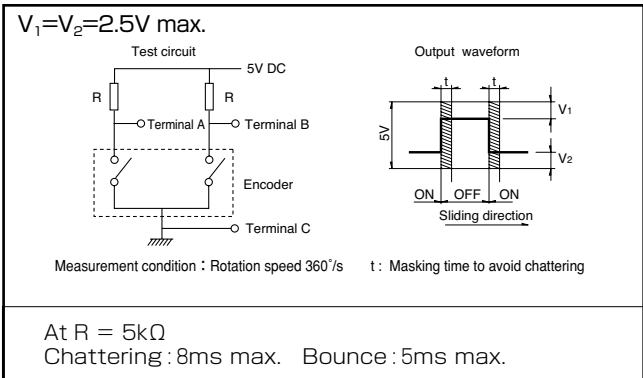

■ Circuit Diagram (RK203)

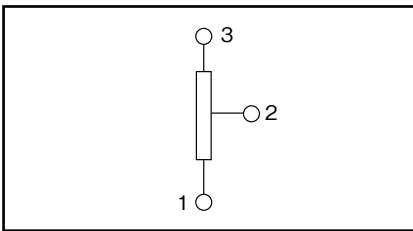

20mm Size Metal Shaft Type / Attached Parts









The following parts are included with the product

|     |  | Unit:mm |
|-----|--|---------|
| Nut |  | Washer  |
|     |  |         |

20mm Size Metal Shaft Encoder Type / Switch Specifications

The attachment switch is applied only for the encoder type.

|                        |  |   |
|------------------------|--|---|
| Switch type            | Momentary push switch                  |   |
| Contact arrangement    | Single pole and single throw (Push-on) |   |
| Travel (mm)            | 1.5±0.5                                |   |
| Operating force        | 4±2N                                   |   |
| Operating life         | 20,000 times                           |   |
| Electrical performance | Rating                                 | 0.1A 5V DC (0.1mA 5V DC min. ratings)                           |
|                        | Contact resistance                     | 100mΩ max. for initial period, 200mΩ max. after operating life. |
|                        | Insulation resistance                  | 10MΩ min. 50V DC  |
|                        | Voltage proof                          | 50V AC for 1 minute or 60V AC for 2 second                      |

| Type                               |  | Metal shaft   | Insulated shaft   |   |   |
|------------------------------------|--|---|---|---|---|
|                                    |  | 20mm size   | 12mm size   |   | 18mm size   |
| Series                             |  | <b>EC20A</b>  | <b>EC12E</b>  | <b>EC12D</b>  | <b>EC18A</b>  |
| Photo                              |  |  |  |  |  |
| Output                             |  | Incremental (Two phase A and B)   |   |   | Absolute type   |
| Shaft types                        |  | Single-shaft  |   |   |   |
| Operating direction                |  | Vertical  |   |   |   |
| Number of pulse / Number of detent |  | 18/18   | 12/12<br>24/24<br>24/without  | 15/30   | 12 positions<br>15 positions<br>16 positions  |
| Features                           |  | —   | —   | With push-on switch   | Water resisting performance (IPX7)  |
| Dimensions (mm)                    | W  | 20.2  | 12.4  | 12.5  | 18.8  |
|                                    | D  | 19.2  | 13.2  | 11.7  | 18  |
|                                    | H  | 10  | 5   |   | 8.75  |
| Operating temperature range        |  | -30°C to +80°C  | -10°C to +70°C  | -40°C to +85°C  | -20°C to +60°C  |
| Operating life                     |  | 30,000 cycles   | 15,000 cycles<br>30,000 cycles  | 30,000 cycles   |   |
| Automotive use                     |  | ●   | —   | ●   | —   |
| Life cycle (availability)          |  |  |  |  |  |
| Electrical performance             | Rating                                       | 1mA 5V DC   | 0.5mA 5V DC   | 1mA 5V DC   | 1mA 10V DC  |
|                                    | Max./min. operating current (Resistive load) | —   | 5mA / 0.5mA   | 10mA / 1mA  | —   |
|                                    | Insulation resistance                        | 10MΩ min. 50V DC  |   | 100MΩ min. 250V DC  | 10MΩ min. 250V DC   |
|                                    | Voltage proof                                | 50V AC for 1 minute or 60V AC for 2s  | 50V AC for 1 minute   | 300V AC for 1 minute or 360V AC for 1s  | 50V AC for 1 minute or 60V AC for 2s  |
| Mechanical performance             | Rotational torque (Without detent)           | —   | 10mN·m max.<br>25±15mN·m<br>40±15mN·m   | —   | —   |
|                                    | Detent torque                                | 40±20mN·m   | 3±2mN·m<br>3 to 20mN·m  | 5±3mN·m<br>10±5mN·m   | 60±20mN·m   |
|                                    | Push-pull strength                           | 100N  | 80N   | 100N  | Push 100N / Pull 50N  |
| Shaft configuration                |  | Flat  | Flat, Through shaft   | Flat  |   |
| Terminal type                      |  | Insertion   |   |   |   |
| Switch Specifications              | Switch type                                  | Push-on switch  | —   | Push-on switch  | —   |
|                                    | Contact arrangement                          | Single pole and single throw (Push-on)  | —   | Single pole and single throw (Push-on)  | —   |
|                                    | Travel (mm)                                  | 1.5±0.5   | —   | 0.5±0.3   | —   |
|                                    | Operating force (N)                          | 4±2   | —   | 3 <sup>+1.5</sup> <sub>-1</sub>   6 <sup>+2.5</sup> <sub>-2</sub>                   | —   |
|                                    | Rating                                       | 0.1A 5V DC<br>(0.1mA 5V DC min. ratings)  | —   | 1mA 5V DC<br>(10mA 5V DC max. ratings)  | —   |
|                                    | Contact resistance                           | 100mΩ max. for initial period;<br>200mΩ max. after operating life.                | —   | 100mΩ max. for initial period;<br>200mΩ max. after operating life.                  | —   |
|                                    | Operating life                               | 20,000 times  | —   | 30,000 times  | —   |
| Page                               |  | 273   | 276   |   | 280   |

Encoders Soldering Conditions ..... 299  
 Encoders Cautions ..... 300

#### Note

● Indicates applicability to all products in the series.

## Reference for Manual Soldering

| Series  | Tip temperature | Soldering time                 | No. of solders |
|---|-----------------|--------------------------------|----------------|
| EC05E, EC09E, EC10E, EC111, EC11B, EC11E, EC11G, EC11K, EC11M, EC11N, EC12D, EC12E, EC18A, EC21A, EC28A, EC35A, EC35AH, EC40A, EC45A, EC50A, EC60B, EM11B, EC21C, EC28C, EC35CH | 350°C max.      | 3s max.                        | 1 time         |
| EC11J   | 350±10°C        | 3 <sup>+1</sup> <sub>0</sub> s | 2 times        |

## Reference for Dip Soldering

| Series   | Preheating                    |              | Dip soldering         |                | No. of solders |
|--|-------------------------------|--------------|-----------------------|----------------|----------------|
|  | Soldering surface temperature | Heating time | Soldering temperature | Soldering time |                |
| EC09E, EC11B, EC111, EC11E, EC11G, EC11K, EC11M, EC11N, EC18A, EC21A, EC28A, EC35A, EC35AH, EC50A, EC60B | 100°C max.                    | 2 min. max.  | 260±5°C               | 5±1s           | 2 times max.   |
| EM11B  | 100°C max.                    | 1 min. max.  | 260°C max.            | 3s max.        | 2 times max.   |
| EC10E, EC12D, EC12E  | 100°C max.                    | 1 min. max.  | 260±5°C               | 3±1s           | 2 times max.   |
| EC40A  | 110°C max.                    | 1 min. max.  | 260°C max.            | 10s max.       | 1 time         |
| EC45A  | 100°C max.                    | 2 min. max.  | 260°C max.            | 5s max.        | 2 times max.   |

## Example of Reflow Soldering Condition

Temperature profile

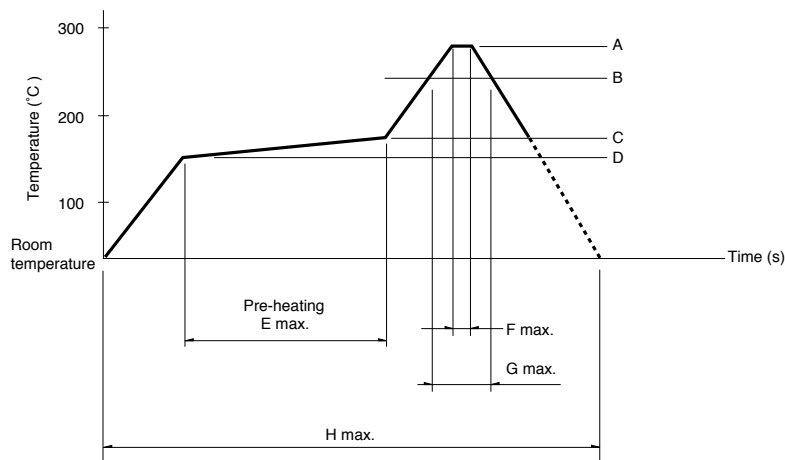

| Series        | A              | B          | C     | D     | E           | F  | G          | H           | No. of reflows |
|---------------|----------------|------------|-------|-------|-------------|----|------------|-------------|----------------|
| EC11J         | 260°C          | 230°C      | 180°C | 150°C | 2 min. max. | 3s | 40s        | 4 min. max. | 2 times max.   |
| EC05E         | 250°C min.     | 230°C min. | 180°C | 150°C | 60s to 120s | —  | 30s to 40s | —           | 2 times max.   |
| EC21C         | 230°C to 245°C | 220°C      | 200°C | 150°C | 60s to 120s | —  | 25s to 60s | 300s max.   | 1 time max.    |
| EC28C, EC35CH | 260°C          | 230°C      | 180°C | 150°C | 2 min. min. | 3s | 40s        | 230s max.   | 1 time max.    |

### Notes

- When using an infrared reflow oven, solder may sometimes not be applied. Be sure to use a hot air reflow oven or a type that uses infrared rays in combination with hot air.
- The temperatures given above are the maximum temperatures at the terminals of the encoder when employing a hot air reflow method. The temperature of the PC board and the surface temperature of the encoder may vary greatly depending on the PC board material, its size and thickness. Ensure that the surface temperature of the encoder does not rise to 250°C or greater.
- Conditions vary to some extent depending on the type of reflow bath used. Be sure to give due consideration to this prior to use.