

LTC3765/LTC3766

150W High Efficiency Active Clamp Forward Converter

DESCRIPTION

Demonstration circuit 1739A-B is a 150W isolated forward converter with synchronous rectification featuring the LTC3765/LTC3766.

This circuit demonstrates a high level of performance, efficiency, and small solution size attainable using these parts in an active-clamp-reset forward converter power supply. It operates at 240kHz and produces a regulated 12V, 12.5A output from an input voltage range of 18V to 72V, making it well suited for telecom, industrial, and other applications. It has an eighth-brick footprint size of 0.90" × 2.3".

Synchronous rectification helps to attain efficiency exceeding 94%. Secondary-side control eliminates complex opto-coupler feedback, providing fast transient response with minimum output capacitance. The proprietary Direct Flux Limit™ scheme guarantees no transformer saturation. For other output requirements, see the LTC3766 data sheet or contact the LTC factory.

Design files for this circuit board are available at <http://www.linear.com/demo>

LT, LT, LTC, LTM, Linear Technology and the Linear logo are registered trademarks of Linear Technology Corporation and Direct Flux Limit is a trademark of Linear Technology Corporation. All other trademarks are the property of their respective owners.

PERFORMANCE SUMMARY (T_A = 25°C)

SYMBOL	PARAMETER	CONDITIONS	MIN	TYP	MAX	UNITS
V _{IN}	Input Supply Range		18		72	V
V _{OUT}	Output Voltage			12.0		V
I _{OUT}	Output Current Range, Continuous	200LFM	0		11	A
I _{OUT}	Output Current, Peak	200LFM			12.5	A
f _{SW}	Switching (Clock) Frequency			240		kHz
V _{OUT P-P}	Output Ripple	V _{IN} = 48V, I _{OUT} = 12A (20MHz BW)		60		mV _{P-P}
I _{REG}	Output Regulation	Line and Load (18-72V _{IN} , 0-12A _{OUT})		±0.08		%
P _{OUT} /P _{IN}	Efficiency (see Figure 3)	V _{IN} = 48V, I _{OUT} = 10A		93.6		%
	Isolation	Basic		1500		VDC
	Approximate Size	Component Area × Top Component Height		2.3 × 0.9 × 0.47		Inches

OPERATING PRINCIPLES

The LTC3765 active clamp forward controller and gate driver is used on the primary and provides start-up, gate drive, and protection functions. Once start-up is accomplished, the LTC3766 high efficiency, secondary-side synchronous forward controller takes over, and provides the LTC3765 with timing information and bias power through a small pulse transformer.

When input voltage is applied, the LTC3765 commences soft-start of the output voltage. When the secondary bias source reaches the undervoltage threshold, the LTC3766 comes alive and takes control by sending encoded PWM gate pulses to the LTC3765 through T3. These pulses also provide primary bias power efficiently over a wide input voltage range.

OPERATING PRINCIPLES

The transition from primary to secondary control occurs at some fraction of the nominal output voltage. From then on, operation and design is simplified to that of a simple buck converter. Secondary control eliminates delays, tames large-signal overshoot, and reduces output capacitance needed to meet transient response requirements.

An optional LC filter stage on the input lowers RMS input current. The filter must have output impedance that is less than the converter input impedance to assure stability. This may require a damping impedance. (See Linear

Technology Application Note AN19 for a discussion of input filter stability.) A source with a 300m Ω or higher ESR at the filter resonant frequency (~100kHz) is one way of providing damping for the filter elements provided on the DC1739A-B. For bench testing, an electrolytic capacitor has been added at the input terminals to provide suitable damping and ripple current capability. The values selected have a filter resonant frequency that is below the converter switching frequency, thus avoiding high circulating currents in the filter.

QUICK START PROCEDURE

Demonstration circuit 1739 is easy to set up to evaluate the performance of the LTC3765/LTC3766. Refer to Figure 1 for proper measurement equipment setup and follow the procedure below:

NOTE. When measuring the output voltage ripple, care must be taken to avoid a long ground lead on the oscilloscope probe. Measure the output voltage ripple by touching the probe tip and ground ring directly across the last output capacitor as shown in Figure 1.

1. Set an input power supply that is capable of 18V to 72V to 18V. Then turn off the supply.
2. Direct an airflow of 200LFM across the unit for sustained operation at full load.
3. With power off, connect the supply to the input terminals $+V_{IN}$ and $-V_{IN}$.
 - a. Input voltages lower than 18V can keep the converter from turning on due to the undervoltage lockout feature of the LTC3765/LTC3766.
 - b. If efficiency measurements are desired, an ammeter capable of measuring 10ADC or a resistor shunt can be put in series with the input supply in order to measure the DC1739A-B's input current.
 - c. A voltmeter with a capability of measuring at least 72V can be placed across the input terminals in order to get an accurate input voltage measurement.

4. Turn on the power at the input.

NOTE. Make sure that the input voltage never exceeds 75V.

5. Check for the proper output voltage of 12V. Turn off the power at the input.
6. Once the proper output voltages are established, connect a variable load capable of sinking 12.5A at 12V to the output terminals $+V_{OUT}$ and $-V_{OUT}$. Set the current for 0A.
 - a. If efficiency measurements are desired, an ammeter or a resistor shunt that is capable of handling 12.5ADC can be put in series with the output load in order to measure the DC1739A-B's output current.
 - b. A voltmeter with a capability of measuring at least 12V can be placed across the output terminals in order to get an accurate output voltage measurement.
7. Turn on the power at the input.

NOTE. If there is no output, temporarily disconnect the load to make sure that the load is not set too high.

8. Once the proper output voltage is again established, adjust the load within the operating range and observe the output voltage regulation, ripple voltage, efficiency and other desired parameters.

QUICK START PROCEDURE

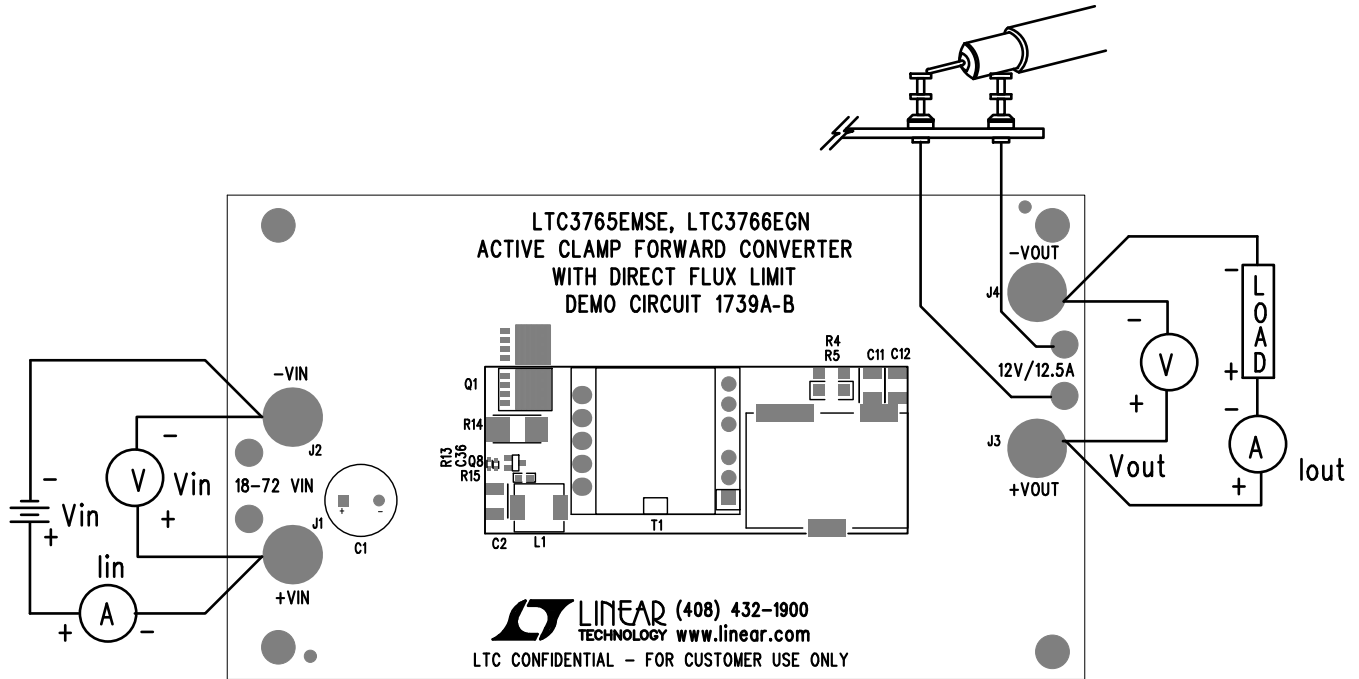

Figure 1. Proper Measurement Equipment Setup

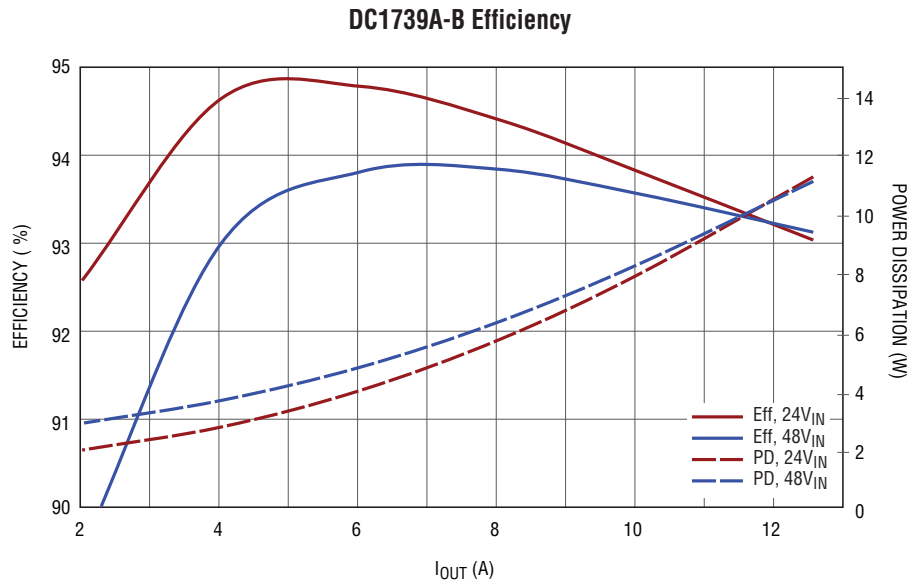

Figure 2. Efficiency and Power Dissipation

QUICK START PROCEDURE

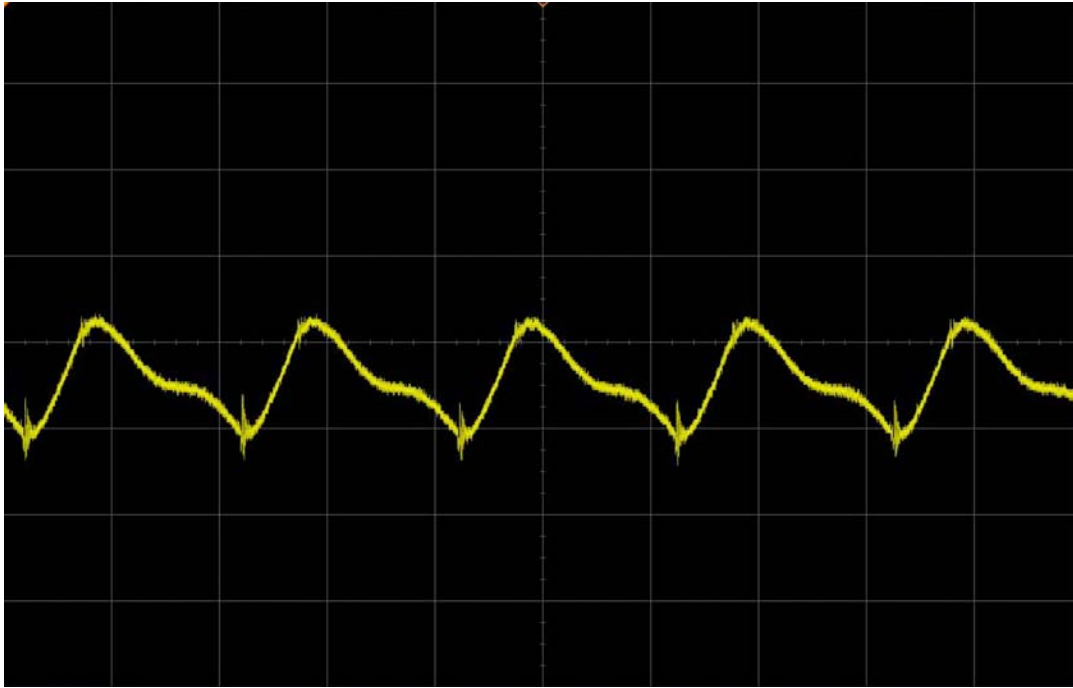

Figure 3. Output Ripple at 48V_{IN} and 11A_{OUT} (50mV, 2 μ s/DIV, 20MHz)

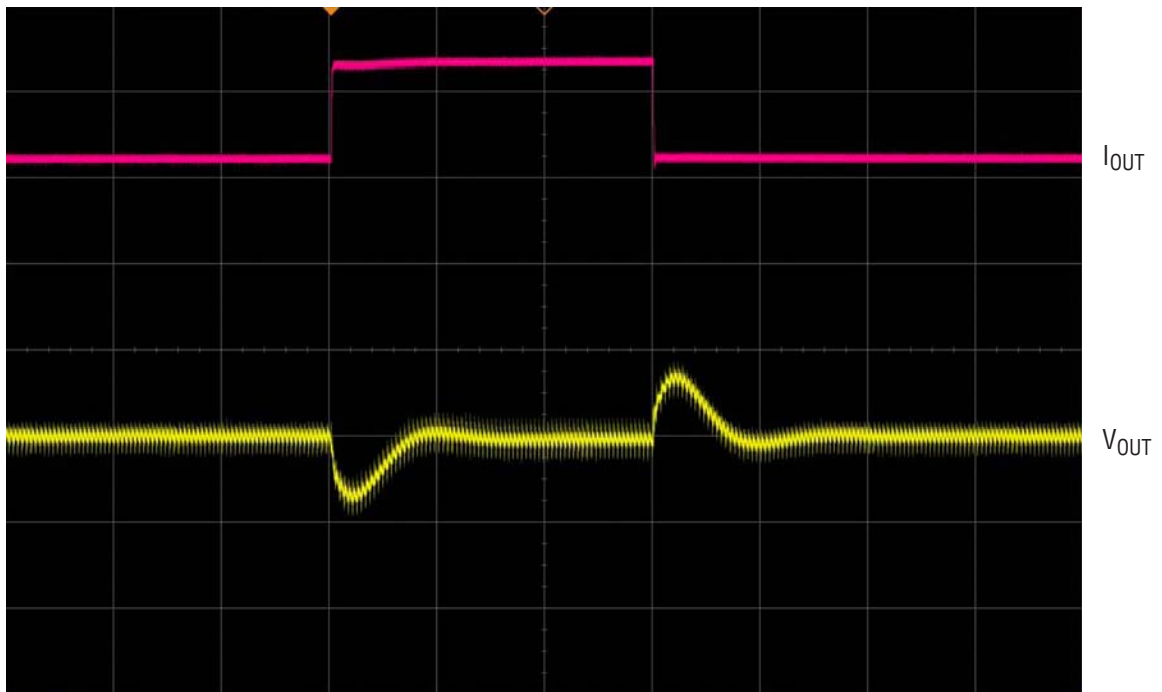

Figure 4. Transient Response Waveform at 48V_{IN} and 6 – 12A_{OUT} (5A, 500mV, 100 μ s/DIV)

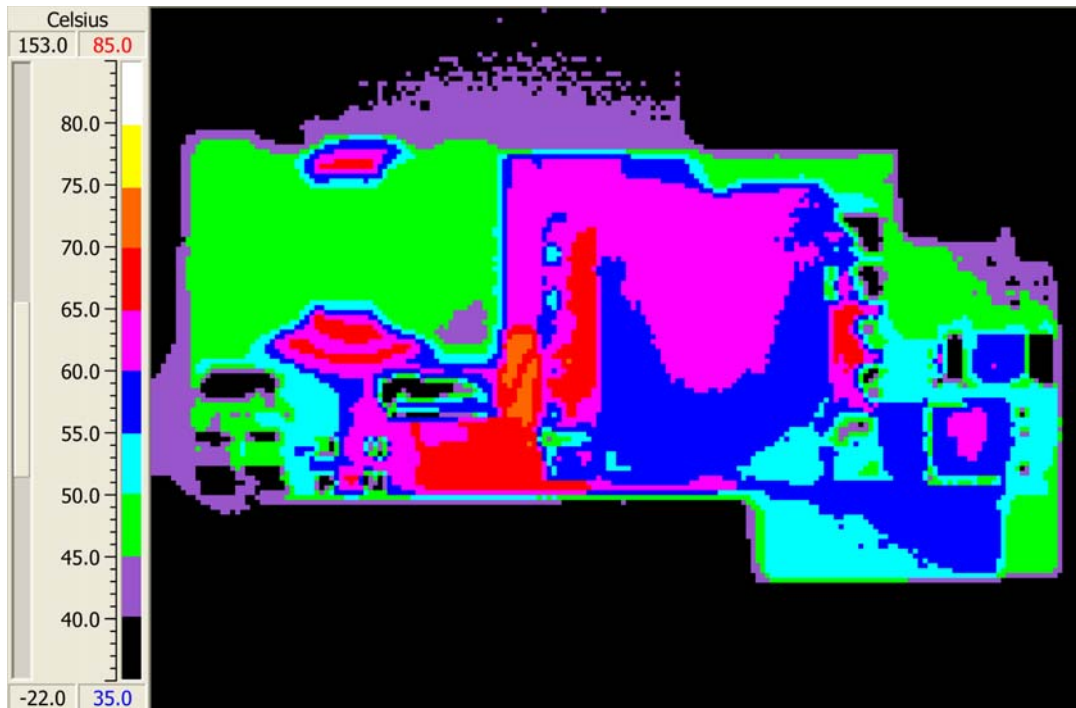

Figure 5. Thermal Map, Frontside at 48V_{IN} and 11A_{OUT} (T_A = 25°C, 200LFM)

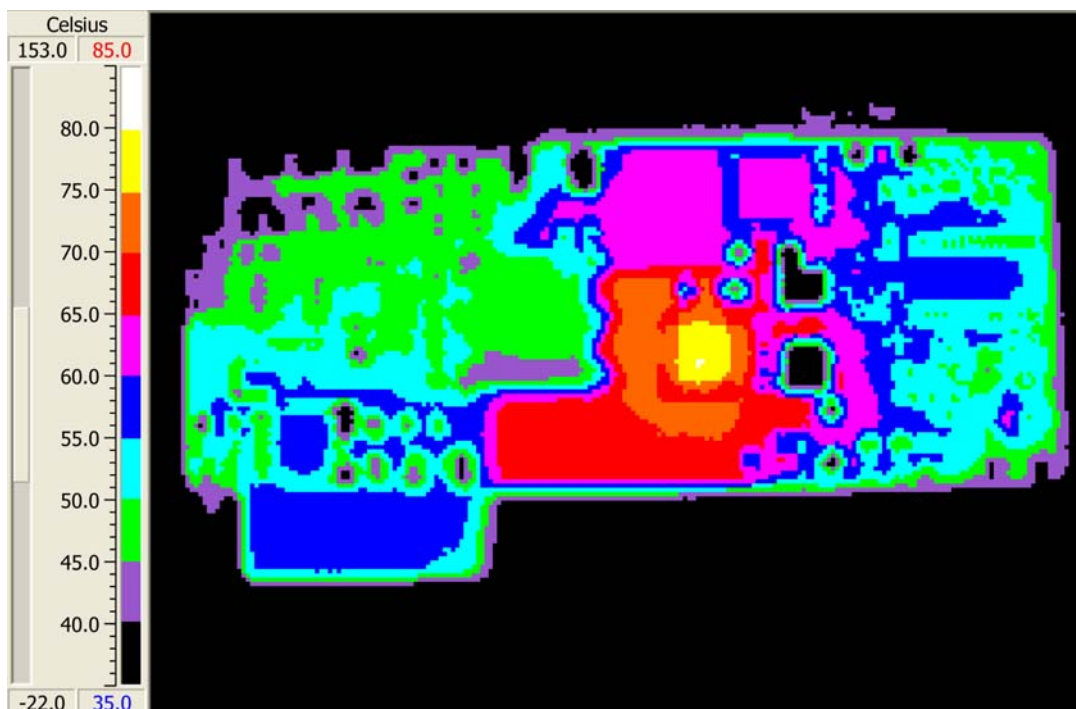

Figure 6. Thermal Map, Backside at 48V_{IN} and 11A_{OUT} (T_A = 25°C, 200LFM)

DEMO MANUAL DC1739A-B

PARTS LIST

ITEM	QTY	REFERENCE	PART DESCRIPTION	MANUFACTURER/PART NUMBER
Required Circuit Components				
1	1	C1	CAP, AL., TH, 33 μ F, 100V, ME-PX series	SUNCON, 100ME33PX
2	4	C2, C3, C4, C5	CAP, X7R, 2.2 μ F, 100V, 20%, 1210	MURATA, GRM32ER72A225MA35
3	1	C6	CAP, C0G, 47pF, 200V, 5%, 1206	AVX, 12062A470JAT2A
4	2	C8, C9	CAP, POSCAP, 68 μ F, 16V, 20%, 7343	SANYO, 16TQC68M
5	1	C10	CAP, X7R, 1.0nF, 630V, 10%, 1206	MURATA, GRM31A7U2J102J
6	2	C11, C12	CAP, X7R, 22 μ F, 16V, 1210	MURATA, GRM32ER71C226ME20
7	1	C13	CAP, X7R, 1.0 μ F, 100V, 10%, 1206	MURATA, GRM31CR72A105KA01
8	1	C14	CAP, X7R, 0.1 μ F, 250V, 10%, 1206	MURATA, GRM31CR72E104KW03
9	1	C16	CAP, C0G, 1000pF, 25V, 5%, 0402	TDK, C1005C0G1E102J
10	3	C17, C20, C35	CAP, X7R, 0.1 μ F, 25V, 10%, 0603	AVX, 06033C104KAT2A
11	1	C18	CAP, C0G, 470pF, 25V, 5%, 0603	AVX, 06033A471JAT2A
12	2	C21, C23	CAP, X7R, 1.0 μ F, 16V 10%, 0805	MURATA, GRM21BR71C105KA01L
13	1	C22	CAP, C0G, 220pF, 25V, 5%, 0603	AVX, 06033A221JAT2A
14	1	C24	CAP, X7R, 2200pF, 250V, 10%, 1812	MURATA, GA343QR7GD222KW01L
15	1	C25	CAP, C0G, 0.033 μ F, 25V, 5%, 0805	TDK, C2012C0G1E333J
17	1	C27	CAP, X7R, 10 μ F, 16V, 1206	MURATA, GRM31CR61C106MA88
18	1	C28	CAP, X7R, 0.010 μ F, 50V, 10%, 0603	AVX, 06035C103KAT2A
19	1	C29	CAP, X7R, 0.033 μ F, 25V, 10%, 0603	AVX, 06033C333KAT2A
20	3	C30, C31, C37	CAP, C0G, 1000pF, 25V, 5%, 0603	AVX, 06033A102JAT2A
21	1	C32	CAP, C0G, 47pF, 25V, 5%, 0603	AVX, 06033A470JAT2A
22	1	C33	CAP, C0G, 2200pF, 25V, 5%, 0603	TDK, C1608C0G1E222J
24	2	D1, D4	DIODE ULTRA FAST 1A 200V SMP	VISHAY, ES1PD-M3 / 84A
25	2	D3, D5	DIODE SCHOTTKY 40V 0.4A SOD323	DIODES INC., ZHCS400TA
26	1	L1	INDUCTOR, 1.5 μ H 20%	VISHAY, IHLP2525EZER1R5M01
27	1	L4	INDUCTOR, 8.0 μ H	PULSE PA2729.802NL
28	1	Q1	MOSFET, N-CH 120V POWERPAK-SO-8	FAIRCHILD, FDMS86201
29	1	Q3	MOSFET, N-CH 80V POWERPAK-SO-8	FAIRCHILD, FDMS86322
30	1	Q4	MOSFET, N-CH 150V POWERPAK-SO-8	FAIRCHILD, FDMS86200
31	1	Q5	MOSFET, P-CH, IRF6217, SO-8	IR, IRF6217TR
32	1	Q6	MOSFET, N-CH, SUPER SOT-6	FAIRCHILD, FDC2512-NL
33	1	Q7	Transistor, NPN, SOT23	DIODES, FMMT491A
34	1	Q8	Transistor, NPN, SOT323	DIODES, MMST3904
35	1	R1	RES., CHIP, 51.1, 1/4W, 1%, 1206	VISHAY, CRCW120651R1FKEA
36	2	R4, R5	RES., CHIP, 68.1k, 1/4W, 1%, 1206	VISHAY, CRCW120668K1FKEA
37	1	R7, R37	RES., CHIP, 909, 1/8W, 1%, 0805	VISHAY, CRCW0805909RFKEA
39	1	R10	RES., CHIP, 0.004, 1W, 1%, 2512	Panasonic, ERJ-M1WTF4M0U
40	1	R11	RES., CHIP, 75, 1/8W, 1%, 0805	VISHAY, CRCW080575R0FKEA
42	1	R14	RES., CHIP, 0.006, 1W, 1%, 2512	Panasonic, ERJ-M1WSF6M0U
ITEM	QTY	REFERENCE	PART DESCRIPTION	MANUFACTURER/PART NUMBER
Required Circuit Components				
44	1	R17	RES., CHIP, 61.9k, 1/8W, 1%, 0805	VISHAY, CRCW080561K9FKEA

PARTS LIST

45	1	R18	RES., CHIP, 100k, 1/8W, 5%, 0805	VISHAY, CRCW0805100KJNEA
46	4	R19, R20, R23, R24	RES., CHIP, 100, 1/32W, 1%, 0402	VISHAY, CRCW0402100RFKEA
47	1	R22	RES., CHIP, 1.82k, 1/4W, 1%, 1206	VISHAY, CRCW12061K82FKEA
48	1	R25	RES., CHIP, 10k, 1/16W, 1%, 0603	VISHAY, CRCW060310K0FKEA
49	1	R27	RES., CHIP, 0.750, 1/8W, 1%, 0805	SUSUMU, RL1220S-R75-F
50	1	R29	RES., CHIP, 19.1k, 1/16W, 1%, 0603	VISHAY, CRCW060319K1FKEA
51	1	R35	RES., CHIP, 1.82k, 1/16W, 1%, 0603	VISHAY, CRCW06031K82FKEA
52	1	R36	RES., CHIP, 11.5k, 1/16W, 1%, 0603	VISHAY, CRCW060311K5FKEA
53	2	R38, R39	RES., CHIP, 100, 1/16W, 1%, 0603	VISHAY, CRCW0603100RFKEA
55	1	R41	RES., CHIP, 4.12k, 1/16W, 1%, 0603	VISHAY, CRCW06034K12FKEA
56	1	R44	RES., CHIP, 56.2k, 1/16W, 1%, 0603	VISHAY, CRCW060356K2FKEA
57	1	R46	RES., CHIP, 60.4k, 1/16W, 1%, 0603	VISHAY, CRCW060360K4FKEA
58	1	R47	RES., CHIP, 15.0k, 1/16W, 1%, 0603	VISHAY, CRCW060315K0FKEA
59	1	R48	RES., CHIP, 4.99k, 1/16W, 1%, 0603	VISHAY, CRCW06034K99FKEA
60	1	R49	RES., CHIP, 1.87k, 1/16W, 1%, 0603	VISHAY, CRCW06031K87FKEA
61	1	R50	RES., CHIP, 604, 1/16W, 1%, 0603	VISHAY, CRCW0603604RFKEA
62	1	R51	RES., CHIP, 13.3k, 1/16W, 1%, 0603	VISHAY, CRCW060313K3FKEA
63	1	R52	RES., CHIP, 22k, 1/16W, 5%, 0603	VISHAY, CRCW060322KJNEA
64	1	R53	RES., CHIP, 8.25k, 1/16W, 1%, 0603	VISHAY, CRCW06038K25FKEA
65	1	R56	RES., CHIP, 1.00k, 1/16W, 1%, 0603	VISHAY, CRCW06031K00FKEA
66	1	T1	TRANSFORMER, 4T:4T:4T	PULSE, PA0801NL
67	1	T3	TRANSFORMER, 1.25T:1T	PULSE, PA3493NL
68	1	U1	I.C. LTC3765EMSE, MSOP-16PIN	LINEAR TECH., LTC3765EMSE
69	1	U2	I.C. LTC3766EGN28, SSOP-GN28	LINEAR TECH., LTC3766EGN

Additional Demo Board Circuit Components

70	0	C7	CAP, OPT, 0805	
71	0	C15	CAP, OPT, 0603	
72	0	C36	CAP, OPT, 0402	
16	1	C26	0 Ω Jumper 0603	VISHAY, CRCW06030000Z0EA
72	0	C34	CAP, OPT, 1206	
73	0	D6	DIODE OPT SOT23	
74	0	L5	INDUCTOR, OPT 1608	
75	0	Q2	MOSFET OPT POWERPAK-SO-8	
	0	Q8	TRANSISTOR OPT NPN SOT323	
38	8	R9, R21, R30-R33, R45, R54	0 Ω Jumper 0402	VISHAY, CRCW04020000Z0ED
76	0	R12, R13, R28, R43	RES., OPT, 0402	
77	0	R15, R26, R42	RES., OPT, 0603	
54	1	R40	0 Ω Jumper 0603	VISHAY, CRCW06030000Z0EA

Hardware For Demo Board Only

78	4	E1, E2, E3, E4	TESTPOINT, TURRET, .090" pbf	MILL-MAX, 2501-2-00-80-00-00-07-0
79	4	J1, J2, J3, J4	Connector, Banana Jack	KEYSTONE, 575-4
80	4	MTGS at 4 Corners	STANDOFF, NYLON .5 1/2"	KEYSTONE, 8833(SNAP-ON)

DEMO MANUAL DC1739A-B

SIMPLE SCHEMATIC DIAGRAM

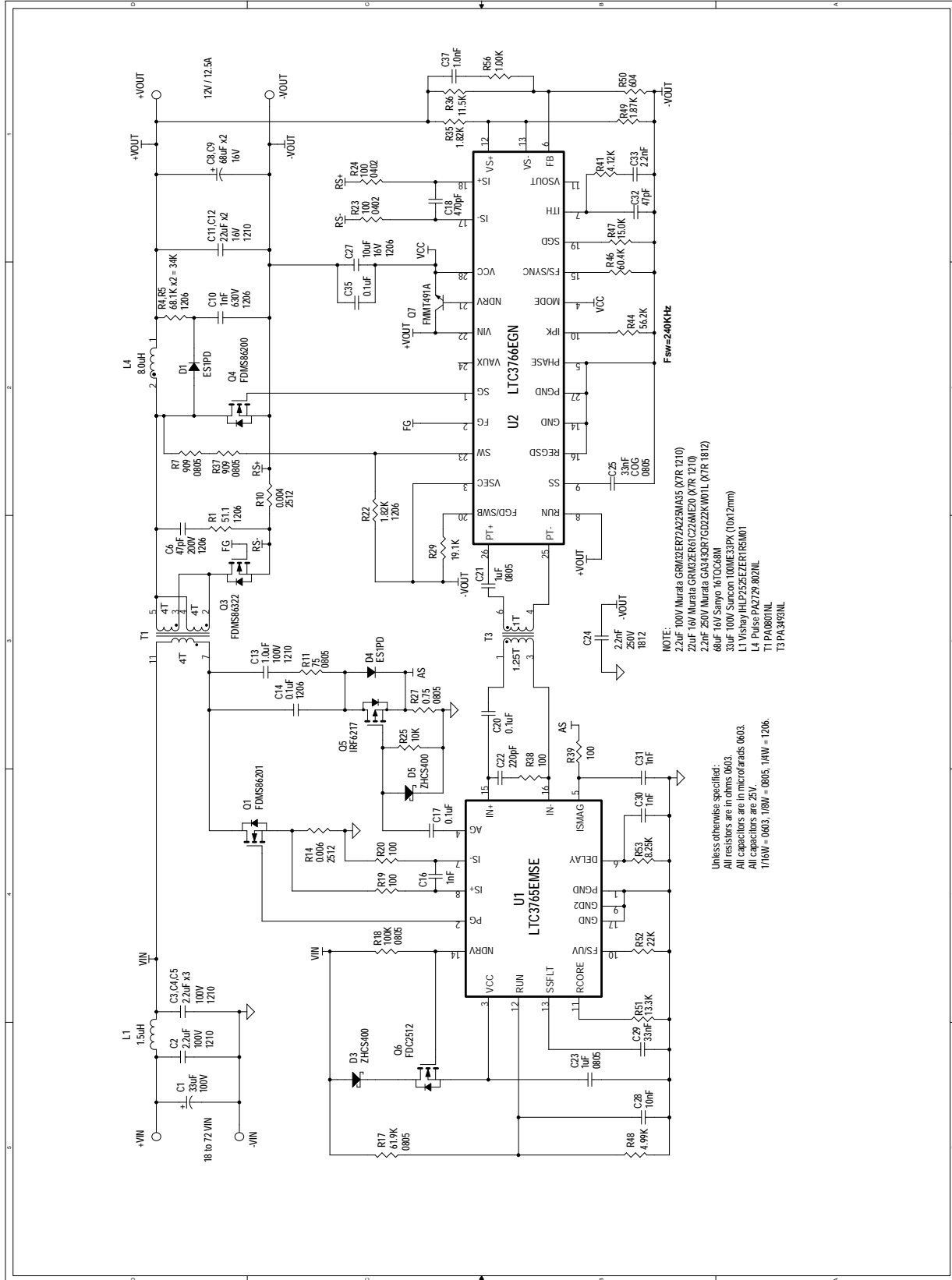

FULL SCHEMATIC DIAGRAM

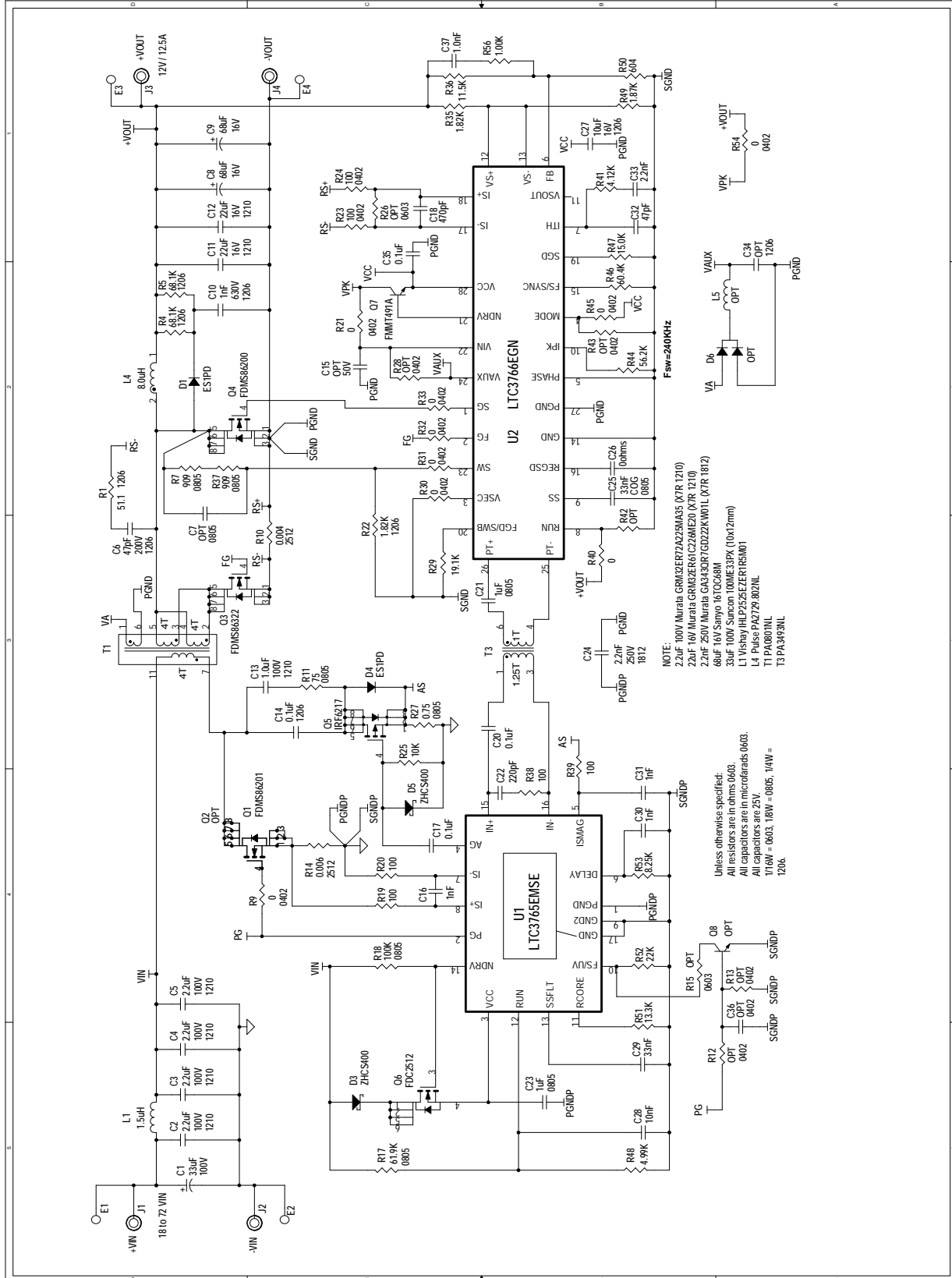

DEMO MANUAL DC1739A-B

DEMONSTRATION BOARD IMPORTANT NOTICE

Linear Technology Corporation (LTC) provides the enclosed product(s) under the following **AS IS** conditions:

This demonstration board (DEMO BOARD) kit being sold or provided by Linear Technology is intended for use for **ENGINEERING DEVELOPMENT OR EVALUATION PURPOSES ONLY** and is not provided by LTC for commercial use. As such, the DEMO BOARD herein may not be complete in terms of required design-, marketing-, and/or manufacturing-related protective considerations, including but not limited to product safety measures typically found in finished commercial goods. As a prototype, this product does not fall within the scope of the European Union directive on electromagnetic compatibility and therefore may or may not meet the technical requirements of the directive, or other regulations.

If this evaluation kit does not meet the specifications recited in the DEMO BOARD manual the kit may be returned within 30 days from the date of delivery for a full refund. **THE FOREGOING WARRANTY IS THE EXCLUSIVE WARRANTY MADE BY THE SELLER TO BUYER AND IS IN LIEU OF ALL OTHER WARRANTIES, EXPRESSED, IMPLIED, OR STATUTORY, INCLUDING ANY WARRANTY OF MERCHANTABILITY OR FITNESS FOR ANY PARTICULAR PURPOSE. EXCEPT TO THE EXTENT OF THIS INDEMNITY, NEITHER PARTY SHALL BE LIABLE TO THE OTHER FOR ANY INDIRECT, SPECIAL, INCIDENTAL, OR CONSEQUENTIAL DAMAGES.**

The user assumes all responsibility and liability for proper and safe handling of the goods. Further, the user releases LTC from all claims arising from the handling or use of the goods. Due to the open construction of the product, it is the user's responsibility to take any and all appropriate precautions with regard to electrostatic discharge. Also be aware that the products herein may not be regulatory compliant or agency certified (FCC, UL, CE, etc.).

No License is granted under any patent right or other intellectual property whatsoever. **LTC assumes no liability for applications assistance, customer product design, software performance, or infringement of patents or any other intellectual property rights of any kind.**

LTC currently services a variety of customers for products around the world, and therefore this transaction **is not exclusive**.

Please read the DEMO BOARD manual prior to handling the product. Persons handling this product must have electronics training and observe good laboratory practice standards. **Common sense is encouraged.**

This notice contains important safety information about temperatures and voltages. For further safety concerns, please contact a LTC application engineer.

Mailing Address:

Linear Technology
1630 McCarthy Blvd.
Milpitas, CA 95035

Copyright © 2004, Linear Technology Corporation