



The AA PowerCool Series is an Air-to-Air thermoelectric assembly (TEA) that uses impingement flow to transfer heat. It offers dependable, compact performance by cooling objects via convection. Heat is absorbed and dissipated thru high density heat exchangers equipped with air ducted shrouds and brand name fans. The thermoelectric modules are custom designed to achieve a high coefficient of performance (COP) to minimize power consumption. This product series is available in a wide range of cooling capacities and voltages. Custom configurations and moisture protection options are available, however, MOQ applies.

Americas: +1.919.597.7300
Europe: +46.31.420530
Asia: +86.755.2714.1166
ets.sales@lairdtech.com
www.lairdtech.com

FEATURES

- Compact design
- Precise temperature control
- Reliable solid-state operation
- DC operation
- RoHS compliant

APPLICATIONS

- Analytical instrumentation
- Medical diagnostics
- Photonics laser systems
- Industrial instrumentation
- Food and beverage cooling

SPECIFICATIONS

Cooling Power Q_{cmax} (W)	58
Running Current (A)	5.7
Startup Current (A)	7.2
Nominal Voltage (V)	12
Max Voltage (V)	15
Power Input (W)	74
Operating Temperature (°C)	-10 to 51
Weight (kg)	2.5
MTBF (fans - hrs)	40,000
Performance Tolerance	10%

PERFORMANCE CURVE

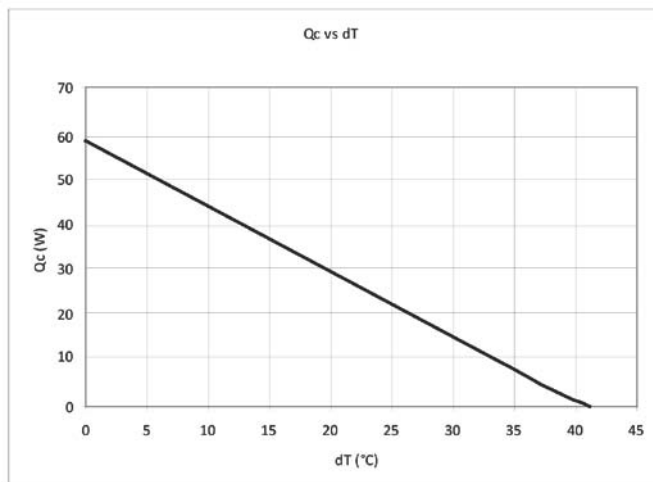

ISOMETRIC DRAWINGS

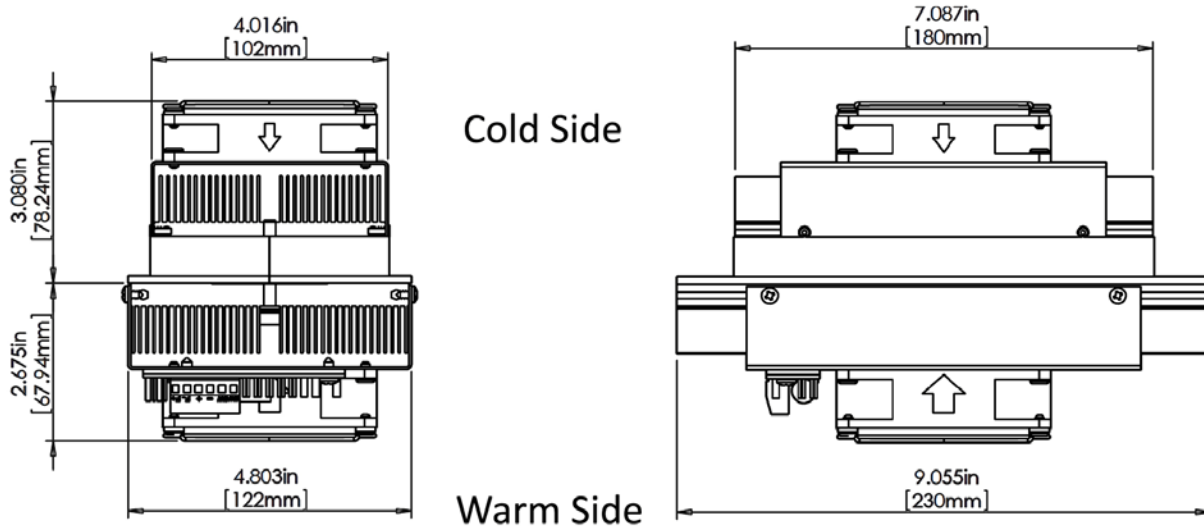

MOUNTING HOLE LOCATION

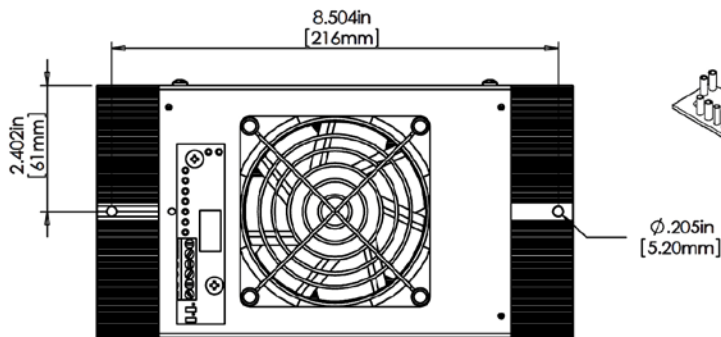

WIRING SCHEMATIC

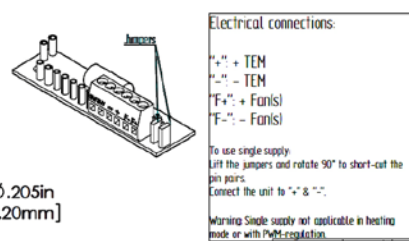

NOTES

For indoor use only

LAIRD-ETS-AA-060-12-22-DATA-SHEET-083116

Any information furnished by Laird Technologies, Inc. and its agents is believed to be accurate and reliable. All specifications are subject to change without notice. Responsibility for the use and application of Laird Technologies materials rests with the end user. Laird Technologies makes no warranties as to the fitness, merchantability, suitability or non-infringement of any Laird Technologies materials or products for any specific or general uses. Laird Technologies shall not be liable for incidental or consequential damages of any kind. All Laird Technologies products are sold pursuant to the Laird Technologies' Terms and Conditions of sale in effect from time to time, a copy of which will be furnished upon request. © Copyright 2016 Laird Technologies, Inc. All Rights Reserved. Laird, Laird Technologies, the Laird Technologies Logo, and other marks are trademarks or registered trademarks of Laird Technologies, Inc. or an affiliate company thereof. Other product or service names may be the property of third parties. Nothing herein provides a license under any Laird Technologies or any third party intellectual property rights.