

Q2L Series - 3x3 QFN

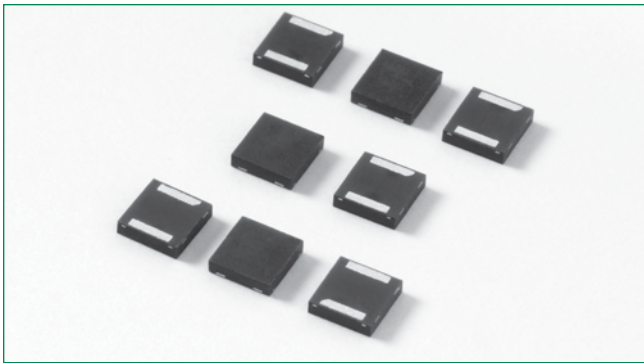

Description

Q2L Series 3x3 QFN are low capacitance SIDACtor® thyristors designed to protect high density broadband equipment from damaging overvoltage transients.

The series provides a low profile surface solution that enables broadband equipment to comply with global regulatory standards while limiting the impact to broadband signals and board space.

Agency Approvals

Agency	Agency File Number
	E133083

Schematic Symbol

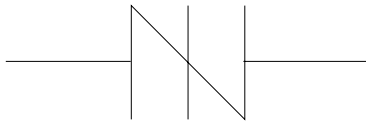

Features and Benefits

- Low voltage overshoot
- Low on-state voltage
- Low capacitance
- Does not degrade surge capability after multiple surge events within limit.
- Small footprint
- Fails short circuit when surged in excess of ratings
- RoHS Compliant and Halogen-Free
- Pb-free E3 means 2nd level interconnect is Pb-free and the terminal finish material is tin(Sn) (IPC/JEDEC J-STD-609A.01)
- Recognized to UL 497B as an Isolated Loop Circuit Protector

Additional Information



Datasheet



Resources



Samples

Applicable Global Standards

- TIA-968-A
- TIA-968-B
- ITU K.20/21/45 Enhanced Level*
- ITU K.20/21/45 Basic Level
- IEC 61000-4-5 2nd edition
- GR 1089 Inter-building*
- GR 1089 Intra-building
- YD/T 1082
- YD/T 993
- YD/T 950

* A/B-Rated parts require series resistance

Electrical Characteristics

Part Number	Marking	V _{DRM} @ I _{DRM} =5μA V min	V _S @ 100V/μs V max	I _H mA min	I _S mA max	I _T A max	V _T @ I _T = 2.2Amps V max	Capacitance @ 1MHz, 2V bias	
								pF Min	pF Max
P0080Q12ALRP	P-8A	6	25	50	800	2.2	5	25	55
P0300Q12ALRP	P03A	25	40	50	800	2.2	5	15	35
P0640Q12ALRP	P06A	58	77	150	800	2.2	5	40	60
P0720Q12ALRP	P07A	65	88	150	800	2.2	5	40	60
P0900Q12ALRP	P09A	75	98	150	800	2.2	5	35	55
P1100Q12ALRP	P11A	90	130	150	800	2.2	5	30	50
P1200Q12ALRP	P12A	100	130	150	800	2.2	5	30	50
P1300Q12ALRP	P13A	120	160	150	800	2.2	5	25	45
P1500Q12ALRP	P15A	140	180	150	800	2.2	5	25	40
P1800Q12ALRP	P18A	170	220	150	800	2.2	5	25	35
P2000Q12ALRP	P20A	180	220	150	800	2.2	5	25	35
P2300Q12ALRP	P23A	190	260	150	800	2.2	5	25	35
P2500Q12ALRP	P25A	230	290	150	800	2.2	5	25	35
P2600Q12ALRP	P26A	220	300	150	800	2.2	5	25	35
P3100Q12ALRP	P31A	275	350	150	800	2.2	5	20	35
P3500Q12ALRP	P35A	320	450	150	800	2.2	5	20	30
P0080Q12BLRP	P-8B	6	25	50	800	2.2	5	25	55
P0300Q12BLRP	P03B	25	40	50	800	2.2	5	15	35
P0640Q12BLRP	P06B	58	77	150	800	2.2	5	40	60
P0720Q12BLRP	P07B	65	88	150	800	2.2	5	40	60
P0900Q12BLRP	P09B	75	98	150	800	2.2	5	35	55
P1100Q12BLRP	P11B	90	130	150	800	2.2	5	30	50
P1200Q12BLRP	P12B	100	130	150	800	2.2	5	30	50
P1300Q12BLRP	P13B	120	160	150	800	2.2	5	25	45
P1500Q12BLRP	P15B	140	180	150	800	2.2	5	25	40
P1800Q12BLRP	P18B	170	220	150	800	2.2	5	25	35
P2000Q12BLRP	P20B	180	220	150	800	2.2	5	25	35
P2300Q12BLRP	P23B	190	260	150	800	2.2	5	25	35
P2500Q12BLRP	P25B	230	290	150	800	2.2	5	25	35
P2600Q12BLRP	P26B	220	300	150	800	2.2	5	25	35
P3100Q12BLRP	P31B	275	350	150	800	2.2	5	20	35
P3500Q12BLRP	P35B	320	400	150	800	2.2	5	20	30

Notes:

- Absolute maximum ratings measured at T_A= 25°C (unless otherwise noted).
- Components are bi-directional.

Surge Ratings

Series	I _{pp}					I _{TSM}	di/dt
	2/10μs	1.2/50μs/8/20μs	10/160μs	10/560μs	10/1000μs	50 / 60 Hz	
	A min	A min	A min	A min	A min	A min	A/μs max
A	150	150	90	50	45	20	500
B	250	250	150	100	80	25	500

Notes:

- Peak pulse current rating (I_{pp}) is repetitive and guaranteed for the life of the product.
- I_{pp} ratings applicable over temperature range of -40°C to +85°C
- The component must initially be in thermal equilibrium with -40°C ≤ T_J ≤ +150°C

Thermal Considerations

Package	Symbol	Parameter	Value	Unit
3x3 QFN 	T _J	Operating Junction Temperature Range	-40 to +150	°C
	T _S	Storage Temperature Range	-65 to +150	°C
	R _{θJA}	Thermal Resistance: Junction to Ambient	120	°C/W

V-I Characteristics

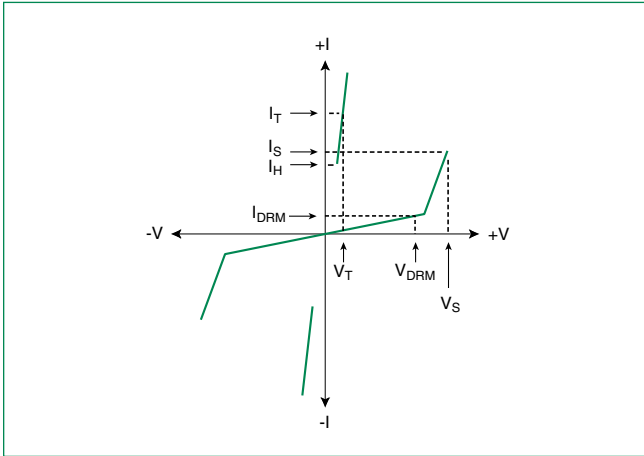

$t_r \times t_d$ Pulse Waveform

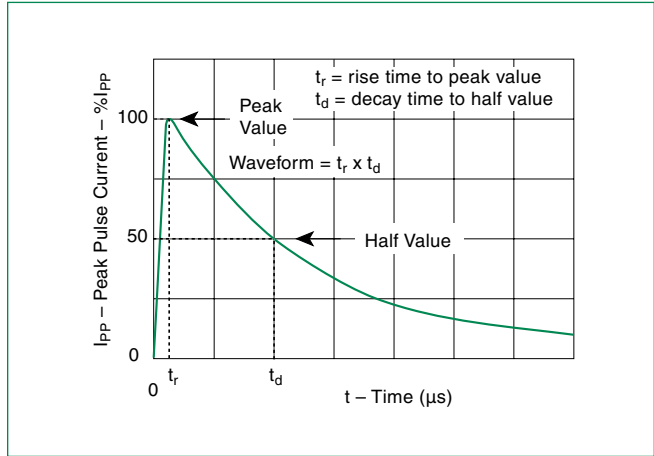

Normalized V_S Change vs. Junction Temperature

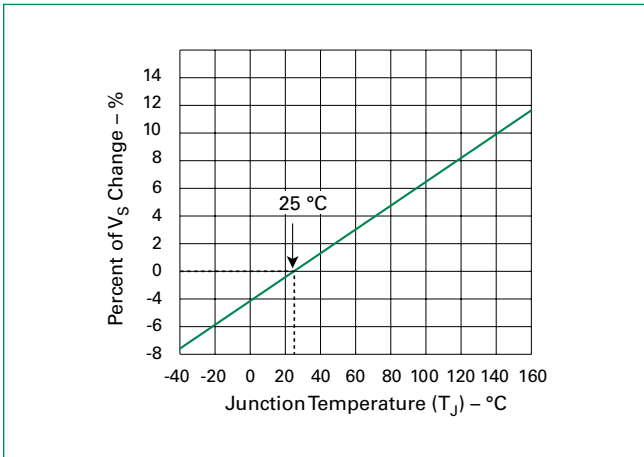

Normalized DC Holding Current vs. Case Temperature

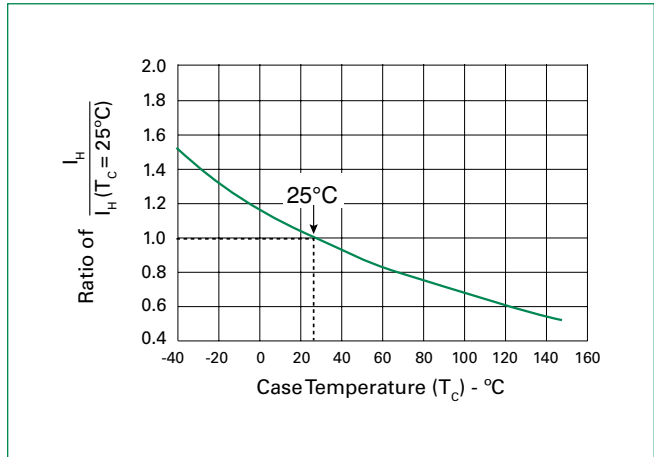

Soldering Parameters

Reflow Condition		Pb-Free assembly
Pre Heat	- Temperature Min ($T_{s(min)}$)	+150°C
	- Temperature Max ($T_{s(max)}$)	+200°C
	- Time (Min to Max) (t_s)	60-180 secs.
Average ramp up rate (Liquidus Temp (T_L) to peak)		3°C/sec. Max.
$T_{s(max)}$ to T_L - Ramp-up Rate		3°C/sec. Max.
Reflow	- Temperature (T_L) (Liquidus)	+217°C
	- Temperature (t_t)	60-150 secs.
Peak Temp (T_p)		+260(+0/-5)°C
Time within 5°C of actual Peak Temp (t_p)		30 secs. Max.
Ramp-down Rate		6°C/sec. Max.
Time 25°C to Peak Temp (T_p)		8 min. Max.
Do not exceed		+260°C

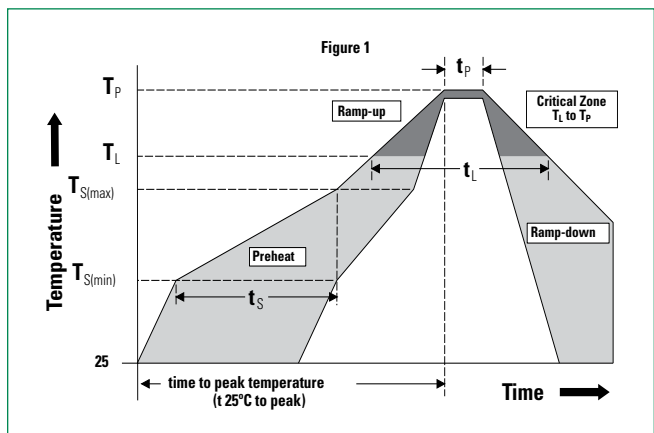

Physical Specifications

Lead Material	Copper Alloy
Terminal Finish	100% Matte-Tin Plated
Body Material	UL Recognized epoxy meeting flammability classification V-0

Environmental Specifications

High Temp Voltage Blocking	80% Rated V_{DRM} ($V_{AC, Peak}$) +125°C or +150°C, 504 or 1008 hrs. MIL-STD-750 (Method 1040) JEDEC, JESD22-A-101
Temp Cycling	-65°C to +150°C, 15 min. dwell, 10 up to 100 cycles. MIL-STD-750 (Method 1051) EIA/JEDEC, JESD22-A104
Biased Temp & Humidity	52 V_{DC} (+85°C) 85%RH, 504 up to 1008 hrs. EIA/JEDEC, JESD22-A-101
High Temp Storage	+150°C 1008 hrs. MIL-STD-750 (Method 1031) JEDEC, JESD22-A-101
Low Temp Storage	-65°C, 1008 hrs.
Thermal Shock	0°C to +100°C, 5 min. dwell, 10 sec. transfer, 10 cycles. MIL-STD-750 (Method 1056) JEDEC, JESD22-A-106
Resistance to Solder Heat	+260°C, 30 secs. MIL-STD-750 (Method 2031)
Moisture Sensitivity Level	85%RH, +85°C, 168 hrs., 3 reflow cycles (+260°C Peak). JEDEC-J-STD-020, Level 1

Dimensions — 3x3 QFN

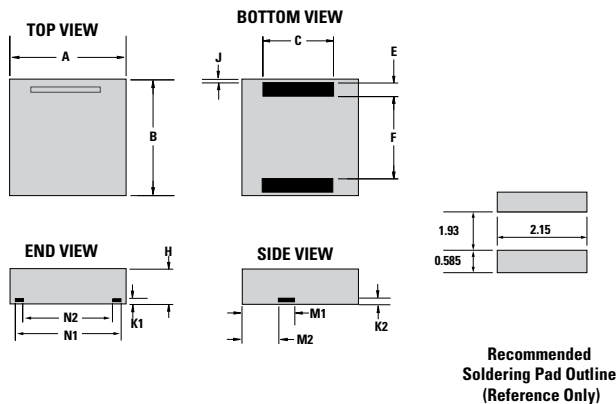

Dimensions	Inches		Millimeters	
	Min	Max	Min	Max
A	0.114	0.122	2.900	3.100
B	0.114	0.122	2.900	3.100
C	0.075	0.083	1.900	2.100
E	0.011	0.019	0.285	0.485
F	0.076	0.084	1.930	2.130
H	0.035	0.043	0.900	1.100
J	0.000	0.008	0.000	0.200
K1	0.004	0.012	0.100	0.300
K2	0.004	0.012	0.100	0.300
M1	0.056	0.064	1.430	1.630
M2	0.038	0.046	0.970	1.170
N1	0.096	0.104	2.440	2.640
N2	0.082	0.090	2.080	2.280

Part Numbering

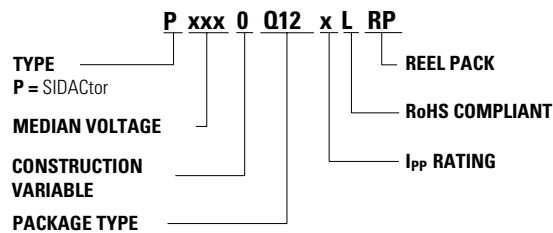

Part Marking

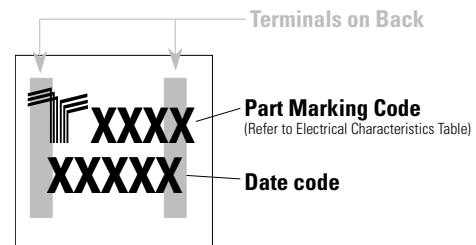

Packing Options

Package Type	Description	Quantity	Added Suffix	Industry Standard
Q12	3x3 QFN Tape and Reel Pack	5000	RP	EIA-481-D

Tape and Reel Dimensions – 3x3 QFN

Reel Dimension

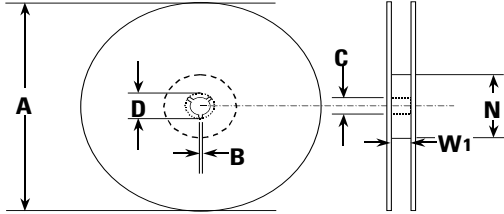

Tape Leader and Trailer Dimensions

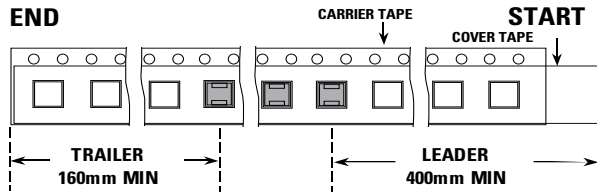

Tape Dimension Items

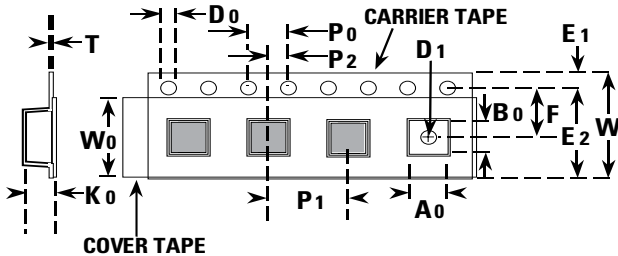

Symbols	Description	Inches		Millimeters	
		Min	Max	Min	Max
A	Reel Diameter	N/A	12.992	N/A	330.0
B	Drive Spoke Width	0.059	N/A	1.50	N/A
C	Arbor Hole Diameter	0.504	0.531	12.80	13.50
D	Drive Spoke Diameter	0.795	N/A	20.20	N/A
N	Hub Diameter	1.969	N/A	50.00	N/A
W ₁	Reel Inner Width at Hub	0.488	0.567	12.40	14.40
A ₀	Pocket Width at bottom	0.126	0.134	3.20	3.40
B ₀	Pocket Length at bottom	0.126	0.134	3.20	3.40
D ₀	Feed Hole Diameter	0.059	0.063	1.50	1.60
D ₁	Pocket Hole Diameter	0.059	N/A	1.50	N/A
E ₁	Feed hole position 1	0.065	0.073	1.65	1.85
E ₂	Feed hole position 2	0.400	0.408	10.15	10.35
F	Feed hole center-Pocket hole	0.215	0.219	5.45	5.55
K ₀	Pocket Depth	0.039	0.051	1.00	1.30
P ₀	Feed Hole Pitch	0.153	0.161	3.90	4.10
P ₁	Component Spacing	0.311	0.319	7.90	8.10
P ₂	Feed hole center-Pocket hole	0.077	0.081	1.95	2.05
T	Carrier Tape Thickness	0.010	0.014	0.25	0.35
W	Embossed Carrier Tape Width	0.453	0.484	11.50	12.30
W ₀	Cover Tape Width	0.358	0.366	9.10	9.30