

REV.	DESCRIPTION	DATE	APPROVED
E	Engineering Update w/o Changes	02/26/04	M. C.
F	Material Update.	11/10/05	M. C.

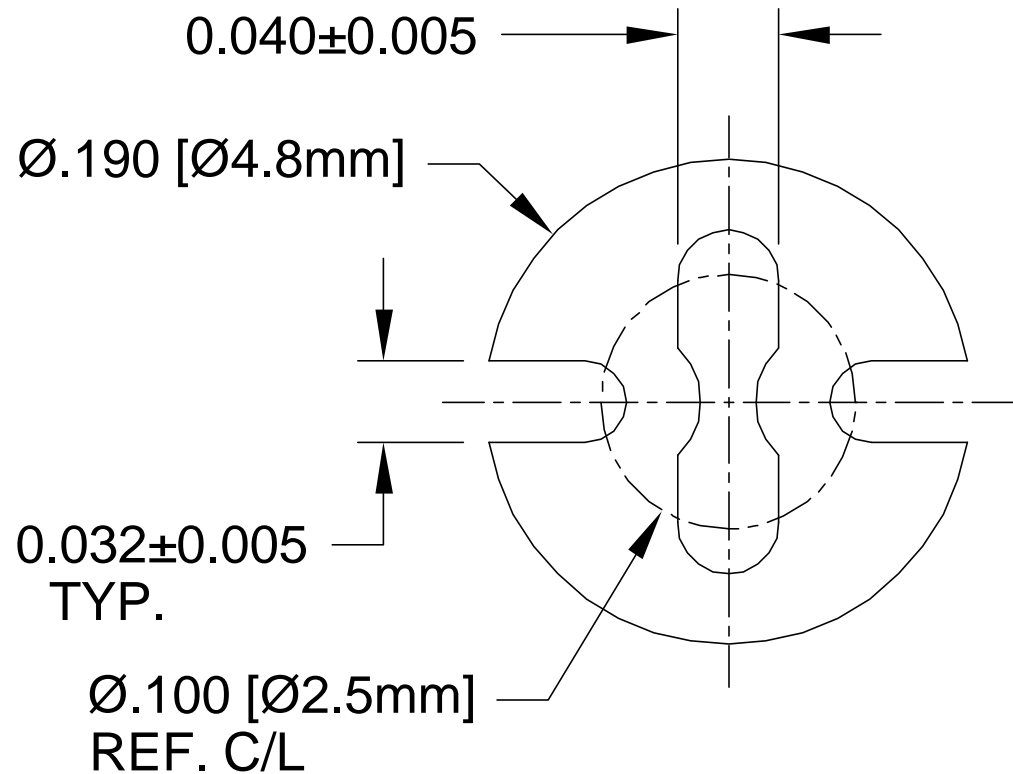

3. TOLERANCE "L" DIMENSION:

- 0.030 - 0.500 (1.0 - 12.7mm)±0.005(0.1mm)
- 0.505 - 0.750 (12.8 - 19.1mm)±0.008(0.2mm)
- 0.755 - 1.250 (19.2 - 31.8mm)±0.015(0.4mm)

2. MATERIAL: PVC ALLOY, 94V-0, BLACK. BIVAR MATERIAL CODE 58-BK.
CYBERTECH CYBERSHIELD PVC ALLOY, CS1534WX-BLK02N BLACK.

1. GENERAL SPECIFICATIONS: BIVAR EXTRUDED PRODUCT SPECIFICATION BV00-E105.

STANDARD TOLERANCE (UNLESS OTHERWISE SPECIFIED)		BIVAR®	
DECIMALS	ANGULAR	4 THOMAS, IRVINE, CA. 92618	
.X ±.1	X° ±1°	TEL: (949) 951-8808 FAX: (949) 951-3974	
.XX ±.01		TITLE: EXTRUDED, SELF-RETAINING LED MOUNT	
.XXX ±.005		PART NO: ELM 2	
DESIGNED: Shane Irving	DATE: 02/03/98	REVISION: F	
CHECKED: M. Chen	DATE: 12/17/02	CAGE CODE : 32559	SHEET # 1 OF 1
CAD GENERATED DOCUMENT. DO NOT MEASURE DRAWING.			