

MAX22192 Evaluation System

Evaluates: MAX22192

General Description

The MAX22192 evaluation system (EV system) provides the hardware and software necessary to evaluate the MAX22192 octal industrial digital input device with diagnostic features and digital isolation. The MAX22192 evaluation kit (MAX22192EVKIT#) has Pmod™ compatible connector for SPI communication, but does not include the USB2PMB2# adapter board. The EV system (MAX22192EVSYS#) includes both the MAX22192EVKIT# and the USB2PMB2# adapter board that receives commands from a PC through the USB port to create an SPI interface for communication between the software and the MAX22192 on the EV kit.

The EV system includes a graphical user interface (GUI) that provides communication between the target device and the PC. The MAX22192 EV kit has a MAX22192 device (U1) and a MAX22190 device (U2), which is an octal industrial digital input device without digital isolation. The EV kit can be configured to operate in multiple modes, as shown in [Figure 1](#):

- 1) **Single-Channel Mode:** The USB2PMB2# adapter communicates with either U1 or U2 on the EV kit, depending on which channel is preferred and selected using the on-board jumpers.
- 2) **Independent Slave Mode:** The USB2PMB2# adapter uses two chip-select signals ($\overline{CS1}$ and $\overline{CS2}$) to control each chip through a single connector/GUI interface.
- 3) **Daisy-Chain Mode:** The USB2PMB2# adapter communicates with both U1 and U2 in SPI daisy-chain mode. The OSDI from U1 connects to SDI of U2, and the SDO of U2 connects to FSDI of U1. Both U1 and U2 are controlled from a single SPI interface.

Windows and Windows XP are registered trademarks and registered service marks of Microsoft Corporation.

Pmod is a trademark of Digilent, Inc

EV System Contents

- MAX22192EVKIT#, including the MAX22192ARC+
- USB2PMB2# Adapter Board
- Micro-USB Cable

Features

- Easy Evaluation of the MAX22192
- EV Kit Logic-Side is USB-Powered
- Configured for IEC 61131-2 Type 1 and 3, and Type 2
- Independent Slave or Daisy-Chain SPI Interface
- Galvanic Isolation using MAX22192 and MAX12931
- Robust Design ± 1 kV Surge Tolerant Line-to-Ground
- Windows® 10, Windows 8.1, Windows 7, and Windows XP® Compatible Software
- Fully Assembled and Tested
- Proven PCB Layout
- RoHS Compliant

[Ordering Information](#) appears at end of data sheet.

MAX22192 EV Kit

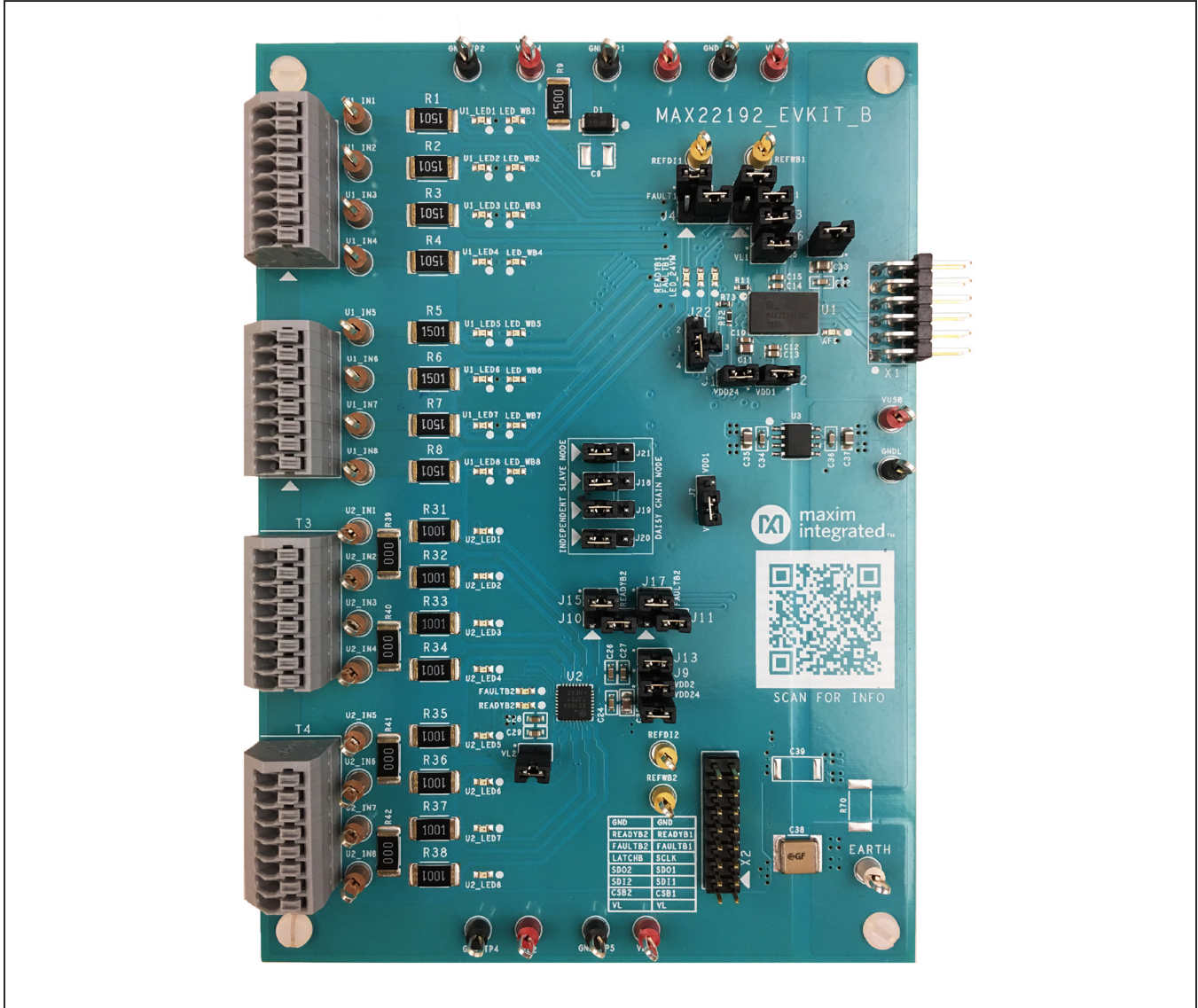

USB2PMB2 Adapter Board

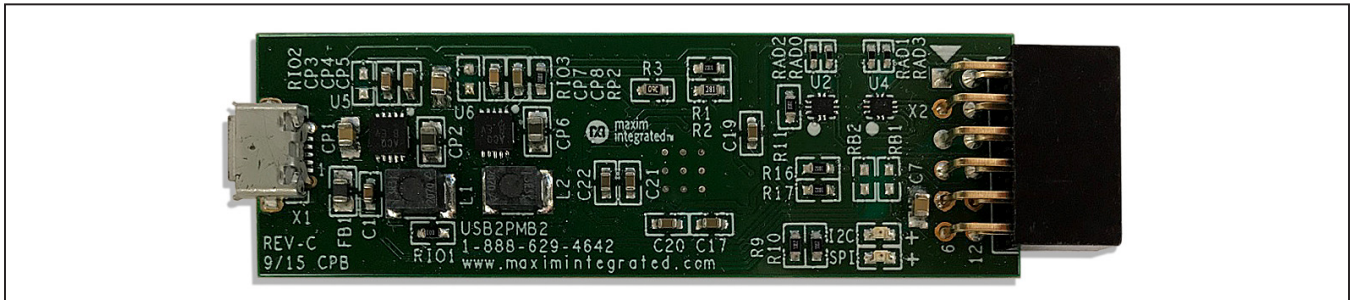

MAX22192 EV System

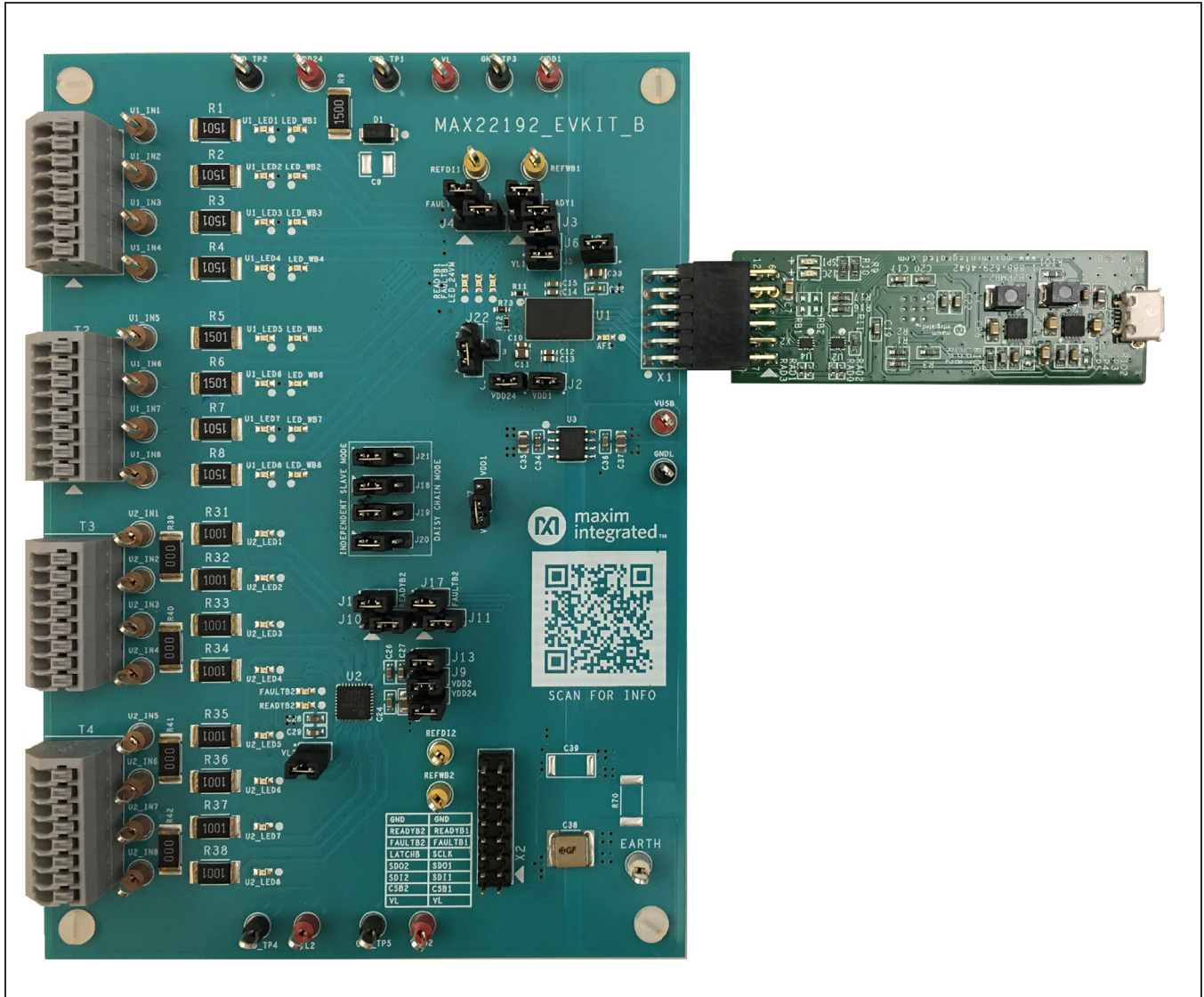

System Block Diagram

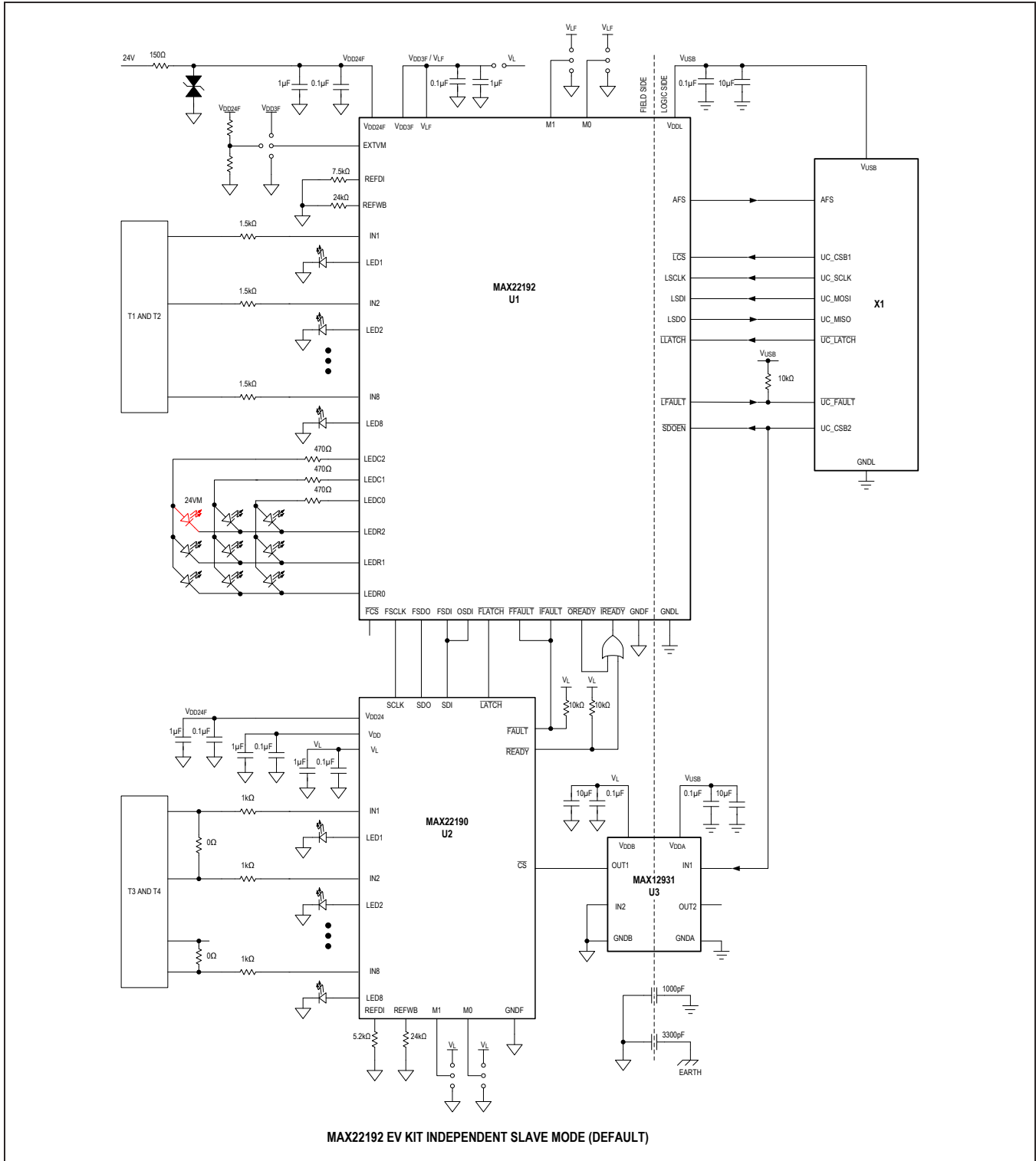

MAX22192 EV KIT INDEPENDENT SLAVE MODE (DEFAULT)

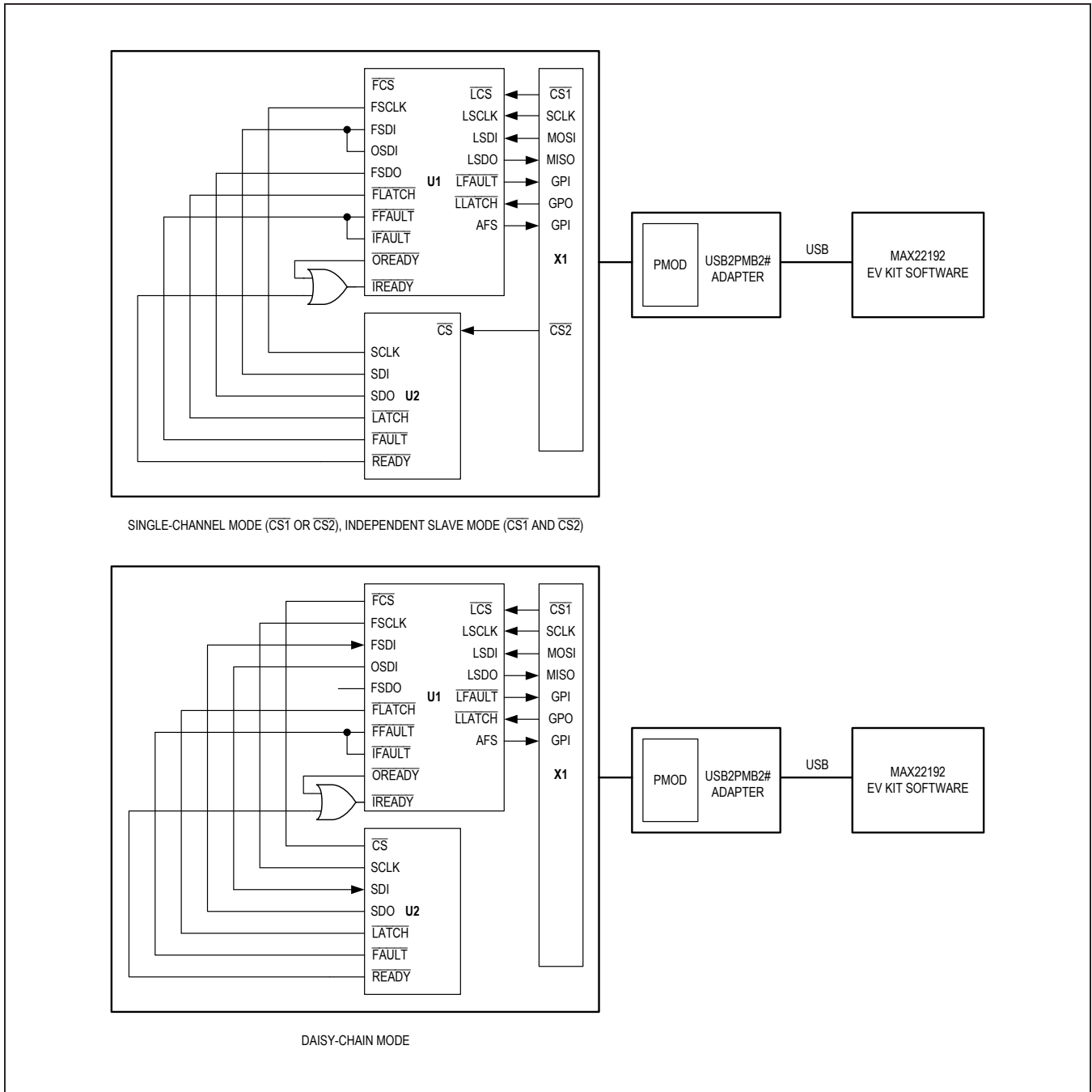

Figure 1: MAX22192 EV Kit Operation Modes

MAX22192 EV Kit Files

FILE	DESCRIPTION
MAX22192EVKitSetupV1.02.ZIP	Application Program

Quick Start

Required Equipment

- MAX22192 EV kit
- USB2PMB2# adapter board
- Micro-USB cable
- 24V DC voltage supply
- Windows 10, Windows 8.1, Windows 7, Window XP PC with a spare USB port

Note: In the following sections, software-related items are identified by bolding. Text in **bold** refers to items directly from the EV kit software. Text in **bold and underline** refers to items from the Windows operating system.

Procedure

The EV kit is fully assembled and tested. The default jumper settings configure the EV kit to operate in the independent slave mode using both U1 and U2. In this configuration, the EV kit “logic side” is powered by +3.3V from the USB2PMB2# adapter connected to the X1 Pmod connector, and the “field side” is powered by the external DC supply connected to VDD24 and GND. U1 is configured for eight Type 1 or Type 3 inputs (terminal blocks T1 and T2) and U2 is configured for four Type 2 inputs (terminal blocks T3 and T4). Follow the steps below to verify the MAX22192 operation:

- 1) Verify all jumper settings are in default position from [Table 1](#).
- 2) For initial testing, MAX22192 EV kit is powered from USB2PMB2# (+3.3V) from the Pmod connector and 24V at VDD24 and GND.
- 3) Visit www.maximintegrated.com to download the latest version of the EV kit software, MAX22192EVKit-SetupV1.02.ZIP.
- 4) Save the EV kit software to a temporary folder and uncompress the ZIP file.
- 5) Install the EV kit software and USB driver on your computer by running the MAX22192EVKitSetupV1.02.exe program inside the temporary folder. A message box asking **Do you want to allow the following program to make changes to this computer?** may appear. If so, click **Yes**.
- 6) The program files are copied to your PC and icons are created in the Windows **Start | Programs** menu. At the end of the installation process, the installer launches the installation for the FTDI Chip CDM drivers.
- 7) The installer includes the drivers for the hardware and software. Follow the instructions on the installer and once complete, click **Finish**. The default location of the software is in the program files directory.
- 8) Connect the MAX22192 EV kit Pmod connector X1 to the connector on the USB2PMB2# adapter.
- 9) Connect the USB2PMB2# to the PC with the micro-USB cable. Windows should automatically recognize the device and display a message near the **System Icon** menu indicating that the hardware is ready to use.
- 10) Connect the DC power supply between the EV kit’s VDD24 and GND_TP1 test points. Set the DC power supply output to 24V, and then enable the output. Observe that, on the EV kit, the FAULTB1, READYB1, LED_24VM, AFS, FAULTB2, and READYB2 LEDs are on, indicating the EV kit is powered up.
- 11) Once the hardware is ready to use, launch the EV kit software by opening its icon in the **Start | Programs** menu. During the EV kit software launch, two message boxes are shown to indicate the default operation mode (independent slave mode), and U1 and U2 SPI Mode (Mode 0). Click **OK** to close the message boxes. The EV kit software appears as shown in [Figure 2](#).
- 12) Verify that the lower-right status bar indicates the EV kit hardware is **Connected**. If the status bar indicates **Disconnected**, from the **Device** menu, click **Connect to Hardware**. Then select a device in the list or use the default device already selected.
- 13) Click **Clear POR** button. Observe that **POR** status lights for U1 and U2 are changed to green, and the **FAULT Signal** status light is also changed to green in the **Configuration** tab as shown in [Figure 3](#).
- 14) Observe that FAULTB1 and FAULTB2 LEDs on the EV kit are turned off.
- 15) Click **Read DI Continuously** button. The EV kit software reads the U1 and U2 DI registers continuously. Connect the 24V DC voltage to one of the input test points, for example, test point U1_IN3. The corresponding **Digital Inputs** status light **IN3** is changed to green from yellow to indicate U1 channel IN3 is high as shown in [Figure 4](#). On the EV kit board, the U1_LED3 LED is also turned on.

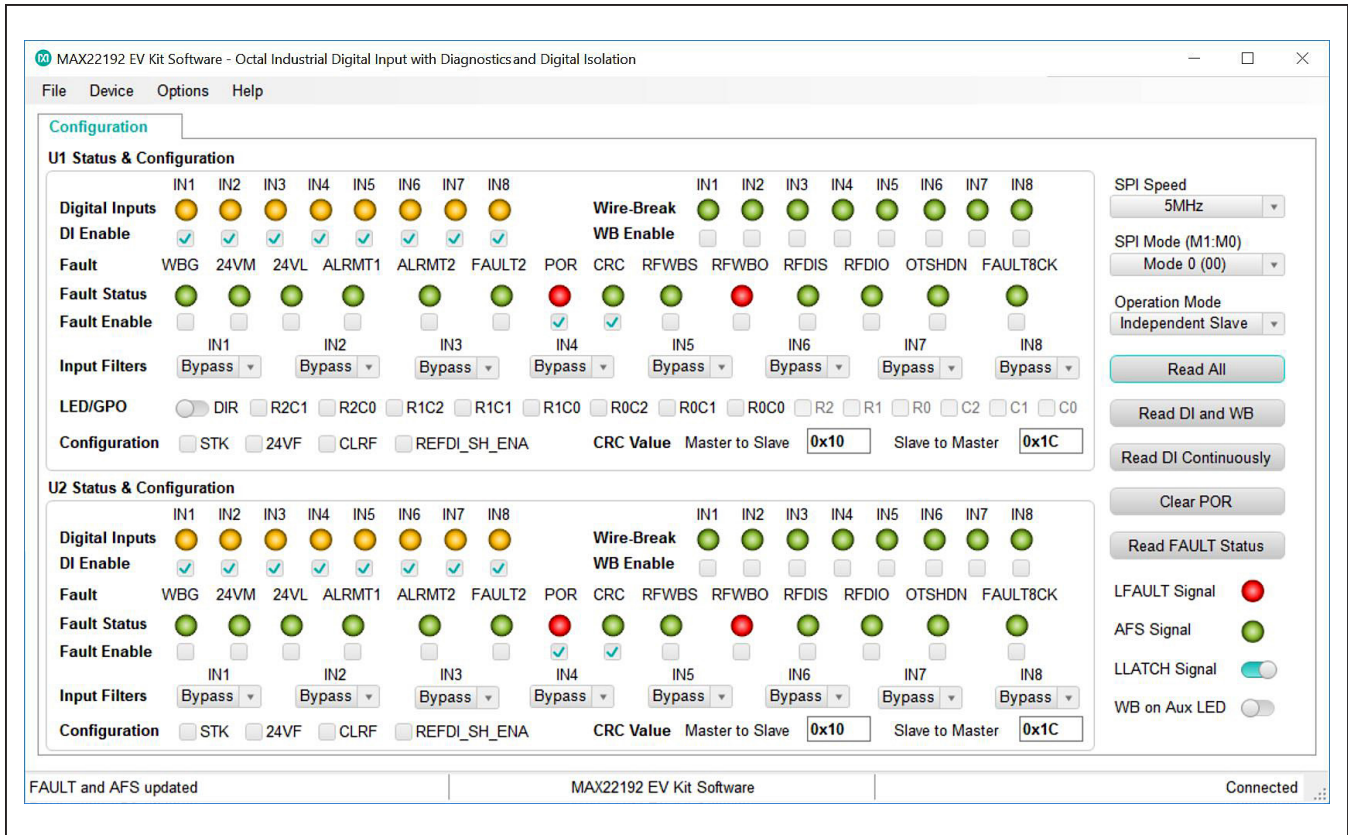

Figure 2. MAX22192 EV Kit Software Startup Window

Table 1. MAX22192 EV Kit Jumper Settings

JUMPER	SHUNT POSITION	DEVICE	DESCRIPTION
POWER			
J1	1-2*	U1	Connect external power supply to U1 V _{DD24F}
	Open		Use current meter to measure U1 V _{DD24F} supply current
J2	1-2*	U1	Connect external power supply from VDD1 test point to U1 V _{DD3F} or connect U1 V _{DD3F} output to the EV kit
	Open		Use current meter to measure U1 V _{DD3F} supply current
J5	1-2*	U1	Connect power supply to U1 V _{LF}
	Open		Use current meter to measure U1 V _{LF} supply current
J6	1-2*	U1	Connect onboard VDD1 voltage supply to U1 V _{LF} supply
	Open		Connect external power supply from VL test point to U1 V _{LF}
J7	1-2	U1 and U2	Power U1 by V _{DD3F} and U2 by V _{DD} with same external power supply
	Open*		Power U1 by V _{DD3F} and U2 by V _{DD} separately, or power both U1 and U2 by V _{DD24}
J8	1-2*	U2	Connect external power supply to U2 V _{DD24}
	Open		Use current meter to measure U2 V _{DD24} supply current
J9	1-2*	U2	Connect external power supply from VDD2 test point to U2 V _{DD} or connect U2 V _{DD} output to the EV kit
	Open		Use current meter to measure U2 V _{DD} supply current

Table 1. MAX22192 EV Kit Jumper Settings (continued)

JUMPER	SHUNT POSITION	DEVICE	DESCRIPTION
J12	1–2*	U2	Connect power supply to U2 V _L
	Open		Use current meter to measure U2 V _L supply current
J13	1–2*	U2	Connect onboard V _L voltage supply to U2 V _L supply
	Open		Connect external power supply from VL2 test point to U2 V _L
J22	1–2	U1	Connect U1 EXTVM to U1 V _{DD3F} to disable V _{DD24F} voltage monitoring 24VL and 24VM faults if the device is powered by V _{DD3F}
	1–3		Connect U1 EXTVM to external resistor divider (R72 and R73) to set external undervoltage thresholds for V _{DD24F}
	1–4*		Connect U1 EXTVM to GNDF to use internal undervoltage thresholds for V _{DD24F} voltage monitoring
J23	1–2*	U1	Connect external power supply from VUSB to U1 V _{DDL} supply
	Open		Use current meter to measure U1 V _{DDL} supply current
SPI			
J3	1–2	U1	U1 SPI Mode M1 = 1
	2–3*		U1 SPI Mode M1 = 0
J4	1–2	U1	U1 SPI Mode M0 = 1
	2–3*		U1 SPI Mode M0 = 0
J10	1–2	U2	U2 SPI Mode M1 = 1
	2–3*		U2 SPI Mode M1 = 0
J11	1–2	U2	U2 SPI Mode M0 = 1
	2–3*		U2 SPI Mode M0 = 0
J14	1–2*	U1	Connect U1 $\overline{\text{OREADY}}$ to U1 $\overline{\text{IREADY}}$ isolation channel through an OR gate
	Open		Disconnect U1 $\overline{\text{OREADY}}$ from U1 $\overline{\text{IREADY}}$ isolation channel through an OR gate
J15	1–2*	U2	Connect U2 $\overline{\text{READY}}$ to U1 $\overline{\text{IREADY}}$ isolation channel through an OR gate
	Open		Disconnect U2 $\overline{\text{READY}}$ from U1 $\overline{\text{IREADY}}$ isolation channel through an OR gate
J16	1–2*	U1	Connect U1 $\overline{\text{FFAULT}}$ to U1 $\overline{\text{IFAULT}}$ isolation channel
	Open		Disconnect U1 $\overline{\text{FFAULT}}$ from U1 $\overline{\text{IFAULT}}$ isolation channel
J17	1–2*	U2	Connect U2 $\overline{\text{FAULT}}$ to U1 $\overline{\text{IFAULT}}$ isolation channel
	Open		Disconnect U2 $\overline{\text{FAULT}}$ from U1 $\overline{\text{IFAULT}}$ isolation channel
J18	1–2*	U1 and U2	Connect U2 SDO to U1 FSDO to share SDO isolation channel in the single-channel or independent slave mode
	2–3		Connect U2 SDO to U1 FSDI in the daisy-chain mode
J19	1–2*	U1 and U2	Connect U1 OSDI to U1 FSDI in the single-channel or independent slave mode
	2–3		Connect U1 OSDI to U2 SDI in the daisy-chain mode
J20	1–2*	U1 and U2	Disconnect U1 $\overline{\text{FCS}}$ from U2 $\overline{\text{CS}}$, used in the single-channel or independent slave mode
	2–3		Connect U1 $\overline{\text{FCS}}$ to U2 $\overline{\text{CS}}$ in the daisy-chain mode
J21	1–2*	U1 and U2	Connect U1 FSDI and U2 SDI together in the single-channel or independent slave mode; U1 FSDI is connected to U1 OSDI (J19 in 1–2 position)
	2–3		Disconnect U1 FSDI from U2 SDI in the daisy-chain mode

Table 1. MAX22192 EV Kit Jumper Settings (continued)

JUMPER	SHUNT POSITION	DEVICE	DESCRIPTION
TEST or PROBE POINTS (NEVER INSTALL JUMPERS)			
X2	1, 2	VL, field-side logic supply	
	3	CSB1, U1 chip-select \overline{FCS}	
	4	CSB2, U2 chip-select \overline{CS}	
	5	SDI1, U1 FSDI	
	6	SDI2, U2 SDI	
	7	SDO1, U1 FSDO	
	8	SDO2, U2 SDO	
	9	SCLK, U1 and U2 field-side serial clock	
	10	LATCHB, U1 field-side \overline{FLATCH} and U2 field-side \overline{LATCH} signal	
	11	FAULTB1, U1 \overline{FFAULT} signal	
	12	FAULTB2, U2 \overline{FAULT} signal	
	13	READYB1, U1 \overline{OREADY} signal	
	14	READYB2, U2 \overline{READY} signal	
	15, 16	GND, field-side ground	

*Default position

Table 2. MAX22192 EV Kit Jumper Settings for Different Operation Modes

JUMPER	SINGLE-CHANNEL U1	SINGLE-CHANNEL U2	INDEPENDENT SLAVE MODE*	DAISY-CHAIN MODE
J3	2 - 3	2 - 3	2 - 3*	1 - 2
J4	Don't Care	Don't Care	Don't Care*	Don't Care
J10	2 - 3	2 - 3	2 - 3*	1 - 2
J11	Don't Care	Don't Care	Don't Care*	Don't Care
J14	1 - 2	Open	1 - 2*	1 - 2
J15	Open	1 - 2	1 - 2*	1 - 2
J16	1 - 2	Open	1 - 2*	1 - 2
J17	Open	1 - 2	1 - 2*	1 - 2
J18	1 - 2	1 - 2	1 - 2*	2 - 3
J19	1 - 2	1 - 2	1 - 2*	2 - 3
J20	1 - 2	1 - 2	1 - 2*	2 - 3
J21	1 - 2	1 - 2	1 - 2*	2 - 3

*Default position

Detailed Description of Software

When the MAX22192 EV kit software starts, it automatically detects if the EV kit is connected to a PC and indicates it in the status bar at the bottom edge of the GUI. If the software does not recognize the USB2PMB2# adapter board, make sure that the software and all drivers are properly installed, check the USB connection, and go to the **Device** menu and select the **Search for Hardware** option. When the EV kit is properly connected, the MAX22192 (U1) and MAX22190 (U2) devices are read and all controls are updated (see [Figure 2](#)).

The main window of the EV kit software contains three groups of controls: **U1 Status & Configuration**, **U2 Status & Configuration**, and general controls for the EV kit. The U1 or U2 Status and Configuration box provides the controls to directly configure MAX22192 and MAX22190 features such as reading digital inputs, wire-break configuration, input filter configuration, fault status reporting, etc. The general controls for the EV kit allow the user to select the SCLK speed, EV kit operation mode, U1 and U2 SPI mode, LLATCH signal level, etc. Next to the **Configuration** tab, the **Register Map** tab lists all registers in the MAX22192 and MAX22190, and provides direct read and write access to all the control bits (not implemented until software rev. 2.0).

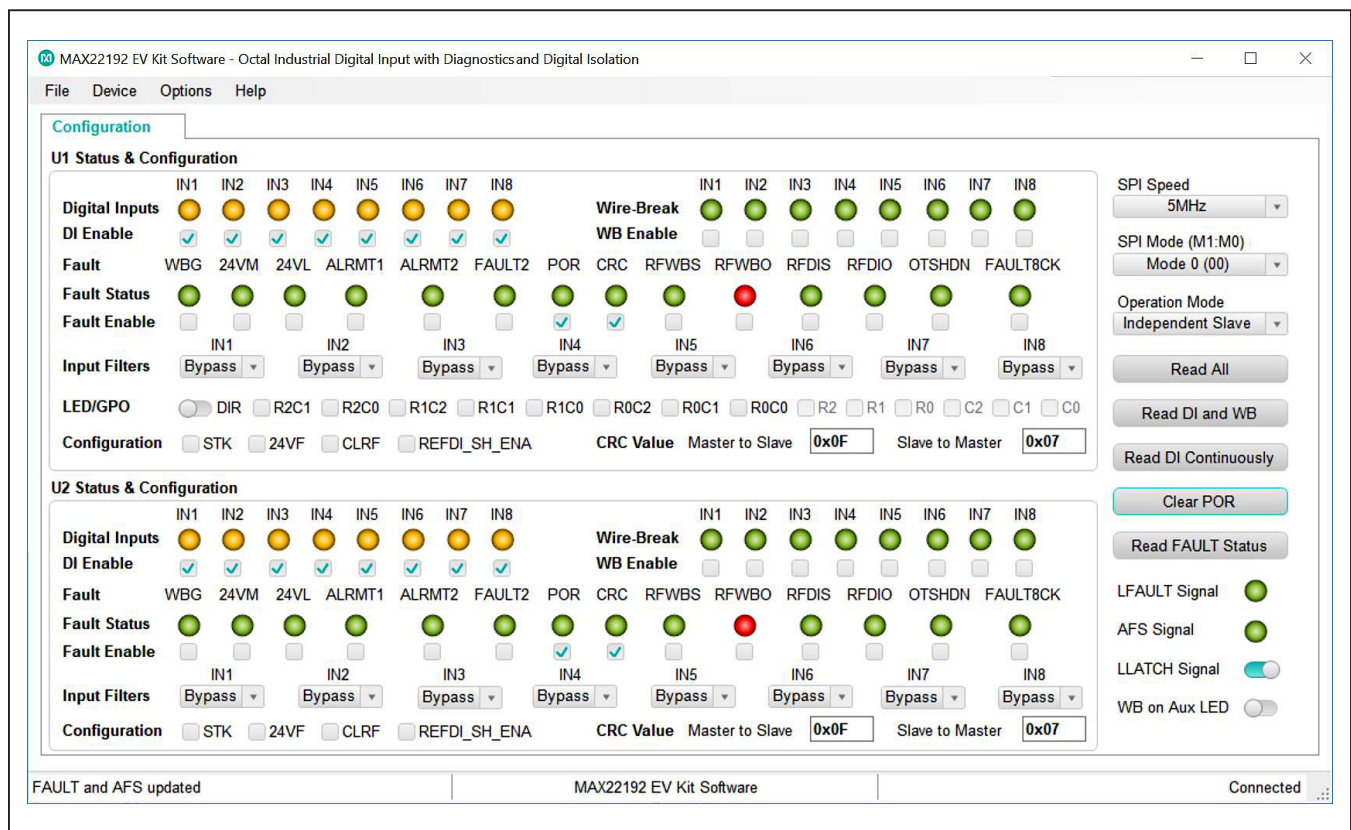

Figure 3. MAX22192 EV Kit Software—Clear POR

If the MAX22192EVKIT# hardware is not connected automatically, the **Device** menu provides the functions to connect or disconnect to the hardware by choosing detected USB2PMB2# serial numbers. Under the **Options** menu, a **CRC Calculator** (Figure 6) is provided to calculate the

5-bit CRC code based on the data frame provided by the user. The jumper positions are shown in the **Jumper Setting Diagram** (Figure 7) under the **Options** menu based on selectable operation mode and SPI mode.

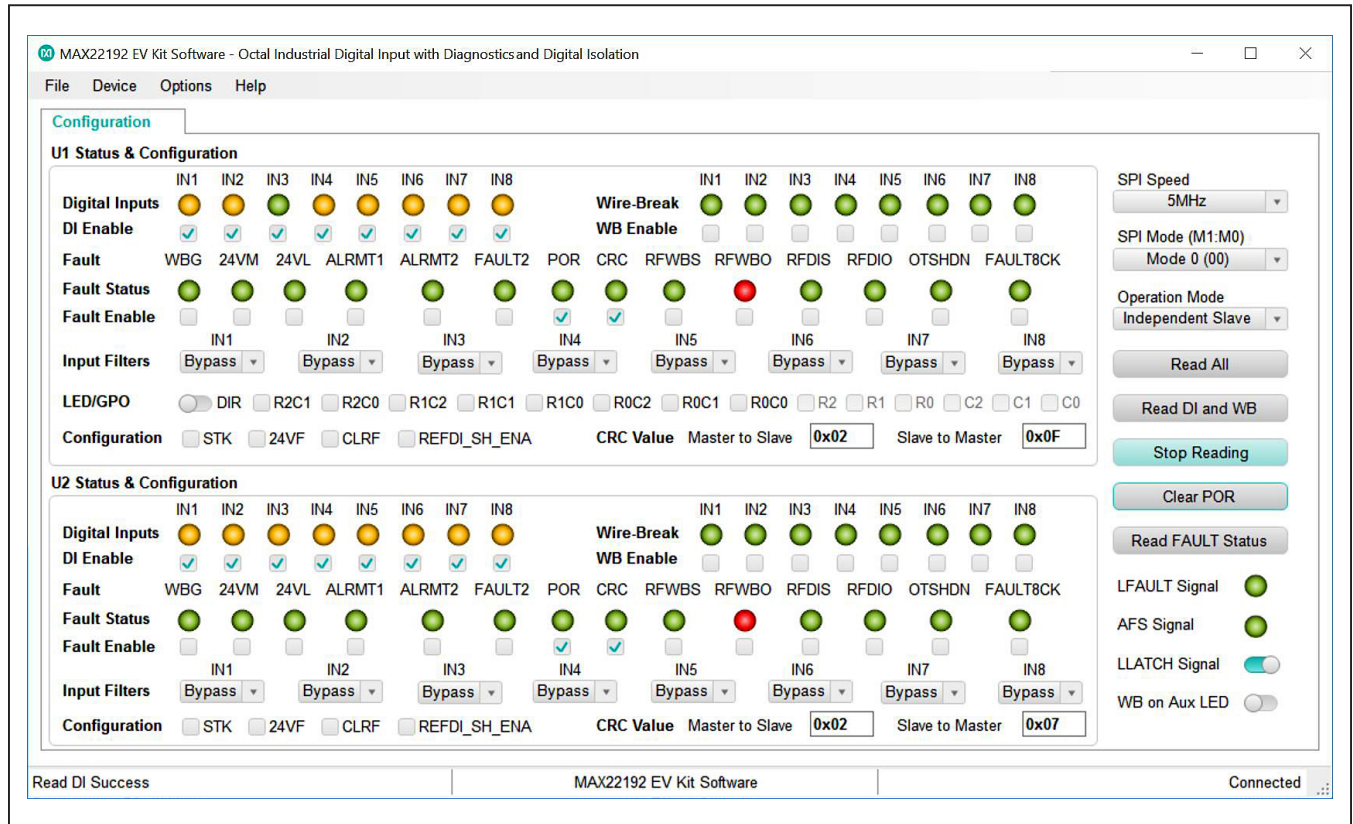

Figure 4. MAX22192 EV Kit Software—Read DI Continuously

Configuration Tab

The **Configuration** tab provides an interface for configuring the MAX22192 and MAX22190 from a functional perspective. Before sending the commands to the MAX22192 and MAX22190, select desired operation mode and SPI mode, and configure the jumpers according to [Table 1](#).

If single-channel mode U1 is selected, all U2 controls are disabled ([Figure 5](#)), and vice-versa. The status and configuration box provides the controls for digital inputs reading, DI channel enable, wire-break status, wire-break enable, fault status reporting, FFAULT pin configuration, input filter configuration, LED and GPO configuration, and CRC value calculation.

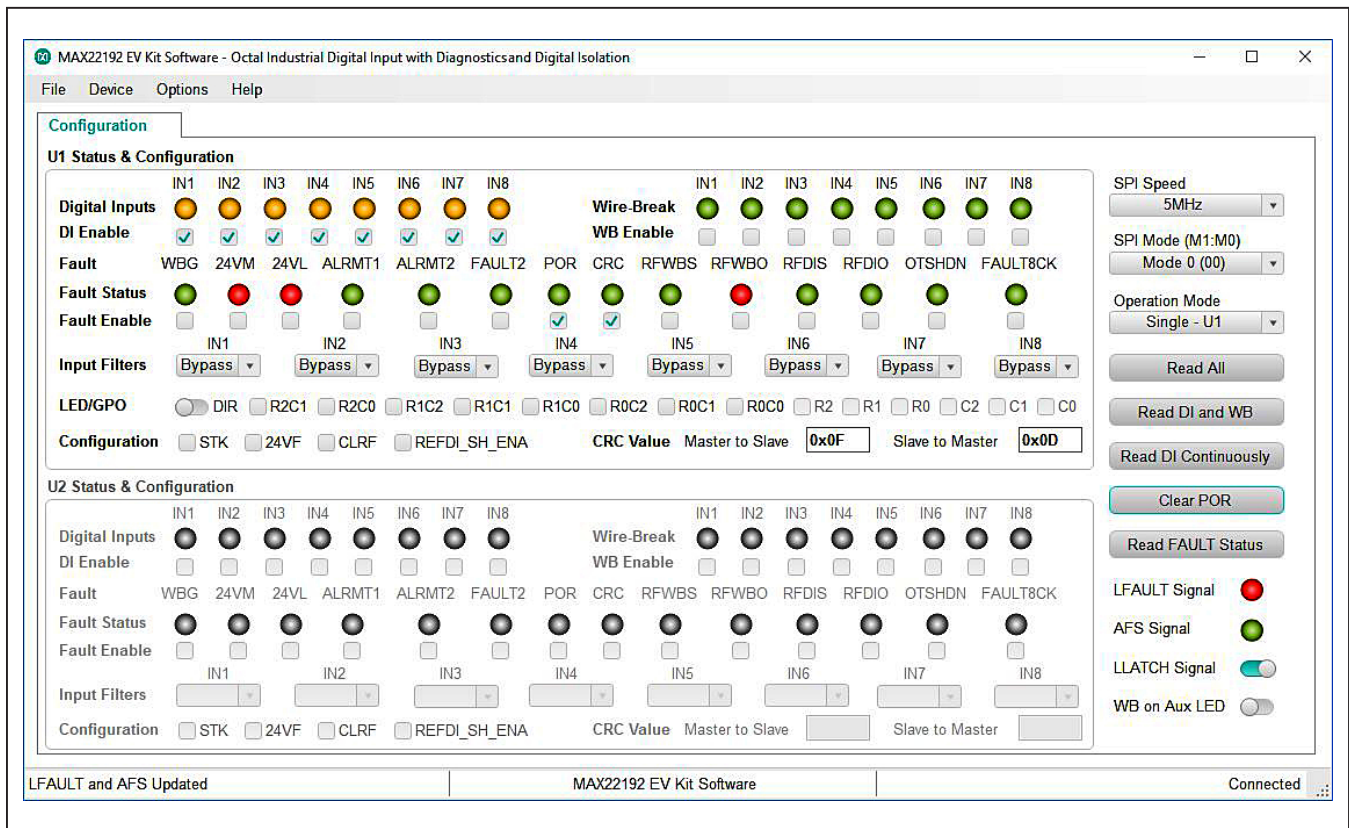

Figure 5. MAX22192 EV Kit Software—Single Channel Mode U1

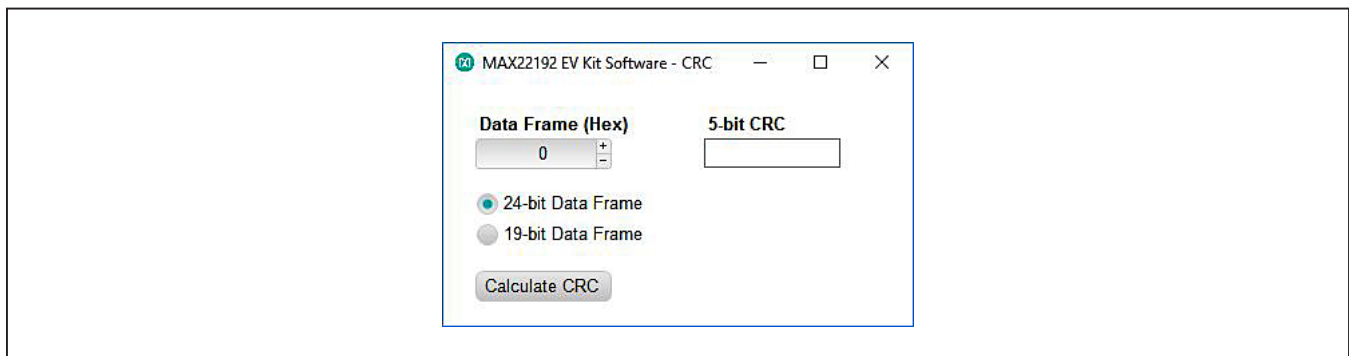

Figure 6. MAX22192 EV Kit Software—CRC Calculator

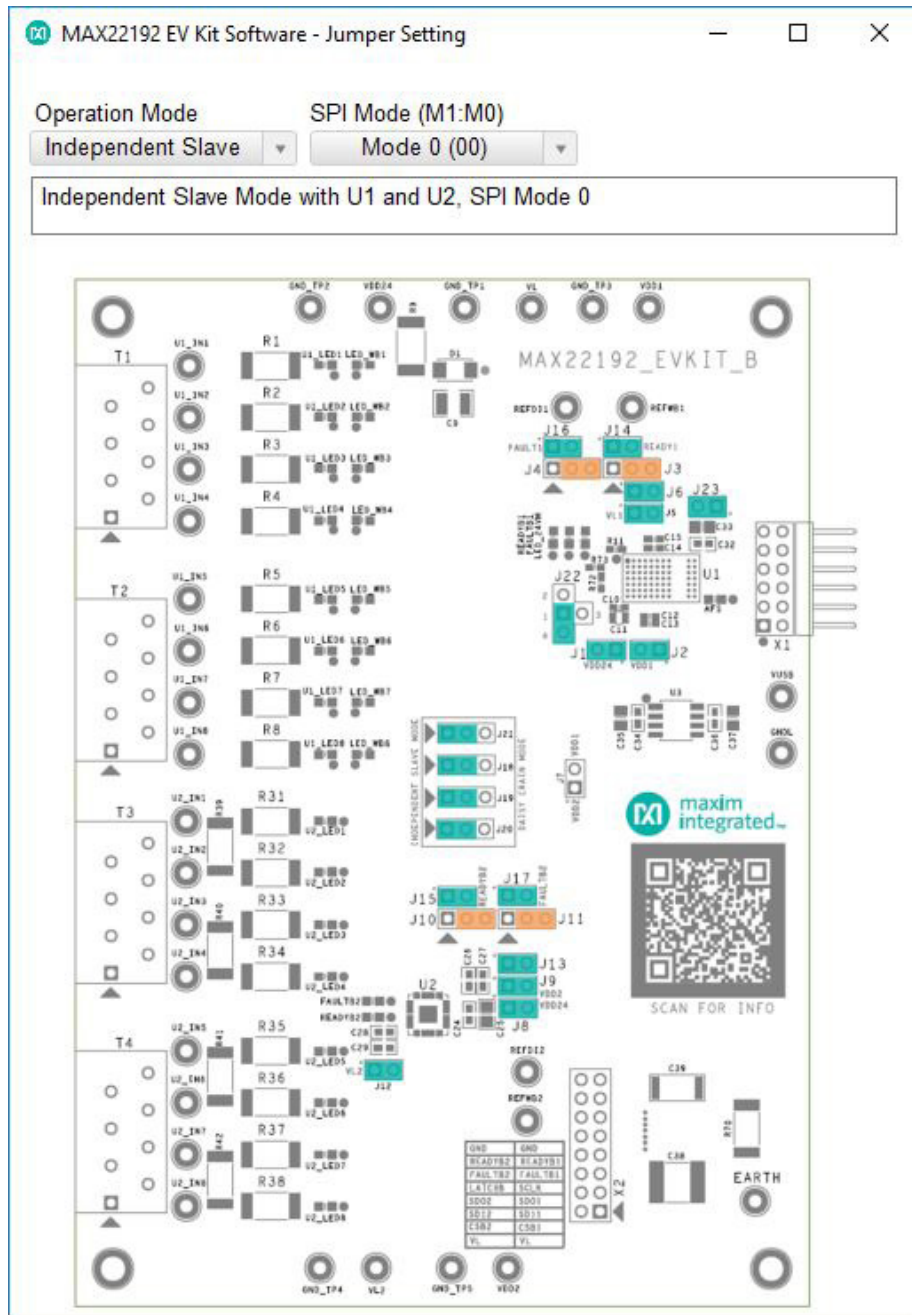

Figure 7. MAX22192 EV Kit Software—Jumper Setting Diagram

After power up, the MAX22192 $\overline{\text{LFAULT}}$ pin is low and the POR bit in the FAULT1 register is set, indicating that a power-on-reset has happened and all registers are set to default (Figure 2). After clicking the **Clear POR** button, the GUI clears the POR bit in the FAULT1 register. The $\overline{\text{LFAULT}}$ pin is pulled high and FAULTB1 and FAULTB2 LEDs are turned off after clearing the POR (Figure 3).

The **Read All** button reads the MAX22192 and MAX22190 registers and refreshes all the controls with current setting. The **Read DI and WB** and **Read DI Continuously** buttons read digital input (DI) and wire-break (WB) registers value and update the corresponding controls. The **Read FAULT Status** button reads the FAULT1 and FAULT2 registers, polls $\overline{\text{LFAULT}}$ and AFS status, and update the corresponding controls.

CRC Calculator

Clicking **CRC Calculator** under the **Options** menu opens the CRC calculation window (Figure 6). The software calculates the 5-bit CRC code based on the 19-bit data or 24-bit data (5 LSB bits are ignored) and display the result.

Jumper Setting Diagram

Clicking the **Jumper Setting Diagram** under the **Options** menu opens the jumper setting window (Figure 7). The software displays the jumper position based on the current operation mode and SPI mode in the top silkscreen diagram. Changing the operation mode and SPI mode updates the shunt positions in the diagram. Note that SPI mode should be set to Mode 0 or Mode 1 in single-channel mode or independent slave mode, or set to Mode 2 or Mode 3 in daisy-chain mode. Daisy-chain mode is not implemented until software version 2.0.

Auxiliary LED Matrix

The MAX22192 features an auxiliary LED matrix that can be configured to indicate the input channel wire-break status. After enabling the **WB on Aux LED** feature, every time the software reads the wire-break status, it writes the WB register value to the LED register to show the wire-break status on the LED matrix on the EV kit hardware. See Figure 8 for an example where IN3 is connected to the field input and all other channels are unconnected.

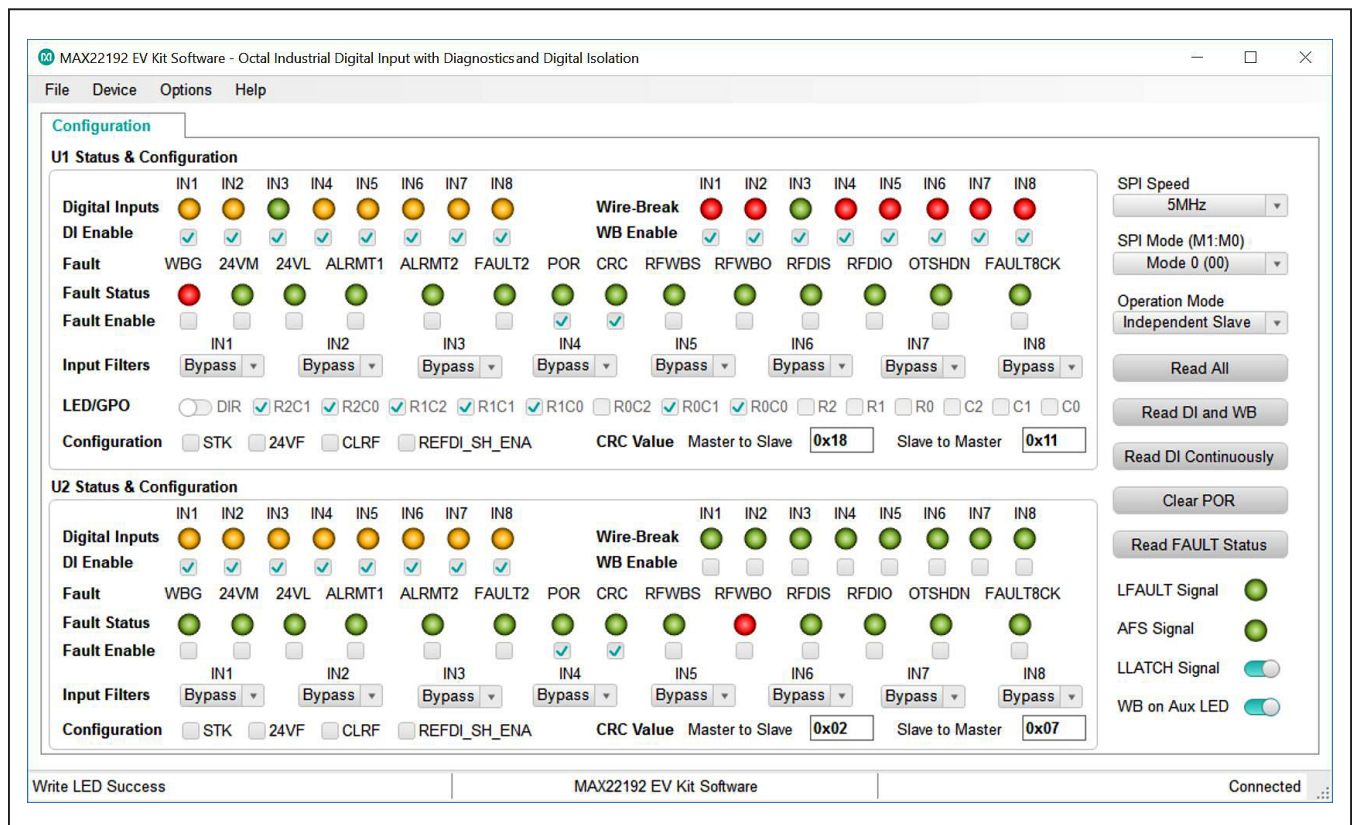

Figure 8. MAX22192 EV Kit Software—WB on Aux LED feature

Register Map

The **Register Map** tab shows all MAX22192 and MAX22190 register information including the register name, address, value, read or write accessibility, and the register description. The **Value** cell can be changed by the user if the register is writable. Pressing the **Enter** key after changing the **Value** writes to the register. When a certain register is highlighted in the register list, the bits' information in this register are displayed in the **Bits Description** table. The bit **Setting** is configurable if the bit is writable, which triggers a write operation to its register.

Clicking the **Read All** button reads all registers and refreshes the window with register settings. Clicking the **Write All** button writes the current settings to all registers.

The Register Map tab is not implemented until software version 2.0.

Detailed Description of Hardware

The MAX22192 EV kit provides a proven layout for a 16-input galvanically isolated digital input solution using MAX22192 and MAX22190. Both MAX22192 and MAX22190 are included with flexibility for operation modes making it easier to evaluate system performance of the MAX22192. This includes different SPI interface modes as well as support for all three types of IEC 61131-2 sensor inputs.

SPI Interface

The EV kit software communicates over USB to the SPI interface and supports full 5MHz clock rate for the MAX22192. The SPI interface can communicate to a single device, or both devices can be daisy-chained. Three SPI operation modes are supported by the EV kit: single-channel mode, independent slave mode, and daisy-chain mode. [Table 2](#) describes how to configure the EV kit jumpers to operate in different operation modes. The EV kit uses a standard Pmod-compatible 12-pin header to connect to an external adapter board (USB2PMB2#), which provides an interface to a PC with an USB port. If the users wish to interface to their own Microcontroller or FPGA, simply hardwire the SPI signals to the Pmod connector X1.

READY Signal

The MAX22192 $\overline{\text{OREADY}}$ signal is an open-drain active-low output. $\overline{\text{OREADY}}$ going low indicates that the MAX22192 field-side is powered up and ready for operation. The MAX22190 $\overline{\text{READY}}$ signal is also an open-drain active-low output. $\overline{\text{READY}}$ going low indicates that the MAX22190 is powered up and ready for operation. Since

the U1 $\overline{\text{OREADY}}$ and the U2 $\overline{\text{READY}}$ are both open-drain active-low outputs, the U1 $\overline{\text{IREADY}}$ is asserted low when one of these $\overline{\text{READY}}$ signals is asserted low if the U1 $\overline{\text{OREADY}}$ and the U2 $\overline{\text{READY}}$ are shorted together and connected to the U1 $\overline{\text{IREADY}}$ isolation channel directly. This could send a false $\overline{\text{READY}}$ signal to the logic-side of the MAX22192 when only one of the U1 and U2 is ready. To make sure both U1 and U2 are ready before asserting $\overline{\text{IREADY}}$ low, an OR gate is added between the U1 $\overline{\text{OREADY}}$ and the U2 $\overline{\text{READY}}$ outputs. The output of the OR gate is connected to the U1 $\overline{\text{IREADY}}$ pin. In this way, only when both U1 and U2 are ready for operation, the U1 $\overline{\text{IREADY}}$ is asserted low, and if the logic-side of the MAX22192 is powered up normally, the AFS is set high to notify the microcontroller that the field-side is ready for operation.

Power Supplies

The EV kit has two power domains, the “logic side,” which is powered from the USB-supplied power (VUSB and GNDL), and the “field side,” which is typically powered from an external 24V DC supply connected to VDD24 and GND. The MAX22192 has an integrated regulator to provide low voltage output to VDD3F (3.3V, nominal) to power other field-side devices such as MAX22190 or a digital isolator such as MAX12931. Alternatively, if an external 24V supply is not available, the field side can be powered using an external 3.0V–5.5V supply through the VDD3F pin of the MAX22192 and leaving VDD24F pin unconnected (refer to [Table 1](#) for jumper settings). The USB2PMB2# adapter board converts the USB 5V supply to a regulated +3.3V supply, which powers the EV kit logic side. Alternatively, if an external microcontroller is used, connect 3.0V–5.5V external supply to test points VUSB and GNDL. The EV kit should be powered from two independent isolated power supplies to evaluate the galvanic isolation. For evaluating the electrical parameters of the device without any isolation between the two sides, a single dual-output power supply can also be used.

Type 1, 3 Inputs (U1)

The MAX22192 senses the state (high or low) of eight digital inputs. U1 is designed to support the trip points (voltage and current) to satisfy the requirements of IEC 61131-2 Type 1 and Type 3 inputs. Resistor R10 sets the current limit value at 2.35mA and input resistors R1–R8 set the voltage threshold to ensure compliance. The input resistors R1–R8 are 1.5k Ω , 1.5W pulse-withstanding resistors to support IEC 61000-4-5 surge tolerance at $\pm 1\text{kV}$ line-to-ground. A separate LED for each input port indicates the status of each input.

Type 2 Inputs (U2)

Type 2 inputs require higher current limits (6mA minimum) and U2 is configured to support four Type 2 inputs by using two MAX22190 inputs in parallel. The current limit for each channel is set to a nominal 3.39mA through resistor R29. To set the correct voltage threshold, R31–R38 are 1k Ω , 1.5W pulse-withstanding resistors. Resistors R39–R42 are 0 Ω resistors to create a pair of inputs. By changing the value of the resistor R29, the current threshold can be set to a different value as desired. A separate LED for each input port indicates the status of the inputs.

Galvanic Isolation

The MAX22192 features a 600V_{RMS} galvanic isolation. The 4-wire SPI, $\overline{\text{LATCH}}$, $\overline{\text{FAULT}}$ and $\overline{\text{READY}}$ signals of both MAX22192 (U1) and MAX22190 (U2) are isolated using the integrated isolation channels in the MAX22192. When the MAX22192 and the MAX22190 are configured in the SPI independent slave mode, a 2-channel MAX12931 is required to isolate a second chip select ($\overline{\text{CS}}$) signal of the MAX22190. When configured in daisy-chain mode, no extra isolation channels are needed. The field-side logic supply V_{LF} can operate between 3.0V–5.5V and logic-side supply V_{DDL} can operate between 1.71V–5.5V. The V_{LF} and V_{DDL} can be set to different logic levels and provide voltage translation as well as galvanic isolation. The logic-side supply V_{DDL} is powered from VUSB and GNDL while the field-side V_{LF} is powered from the MAX22192 internal LDO output (V_{DD3F}). The PCB layout ensures correct creepage and clearance rules are followed. Connector X2 is provided to allow easy probing of digital signals on the field-side of the

isolation barrier. When testing isolation performance, care should be taken not to have a multichannel oscilloscope ground connection to both GND and GNDL.

Protective Earth is provided on the lower-right corner of the EV kit with safety rated Y capacitors between field ground (GND) and Earth (C38), and between field ground (GND) and logic ground (GNDL) (C39) to improve the high-voltage, fast transient performance.

IEC 61000-4 Immunity Compliance

The typical application for the MAX22192 requires it to pass basic transient immunity standards as defined by IEC 61000-4-x, covering -2 for electrostatic discharge (ESD), -4 for electrical fast transient/burst (EFT), and -5 for surge immunity. The MAX22192 EV kit includes circuitry to support testing to these standards including $\pm 1\text{kV}$ line-to-GND surge, $\pm 8\text{kV}$ contact ESD, and $\pm 15\text{kV}$ air-gap ESD. Pulse-withstanding resistor R9 and TVS D1 provide protection from surge and ESD voltage applied through VDD24. Input capacitors can impact surge performance. It is NOT recommended to populate input capacitors (C1–C8, C16–C23) if the highest surge immunity performance is required. To achieve the best surge performance, place a minimum 1k Ω pulse-withstanding resistor between the field input and the device input pin. C38 is a 3300pF safety rated Y capacitor placed between protective earth (PE) and field ground (GND) to improve transient immunity (EFT). C39 is a 1000pF safety rated Y capacitor connected across the isolation barrier between field ground and logic ground (GNDL). For systems where PE and GNDL are bonded together, the user can install the resistor R70. Both C39 and R70 are provided with the EV kit.

Ordering Information

PART	TYPE
MAX22192EVKIT#	EV Kit
MAX22192EVSYS#	EV System

#Denotes RoHS compliant.

The MAX22192EVSYS# includes the MAX22192EVKIT# and USB2PMB2#.

MAX22192 EV Kit Bill of Materials

ITEM	REF DES	DNI/DNP	QTY	MFG PART #	MANUFACTURER	VALUE	DESCRIPTION
	AFS_LED_24VM_LED_WB1-LED_WB8_READYB1_READYB2	-	12	LTST-C193KSKT-5A	LITE-ON ELECTRONICS INC.	LTST-C193KSKT-5A	DIODE; LED; YELLOW; SMT (0603); VF=2V; IF=0.005A
	C10, C12, C14, C24, C26, C28, C30, C32, C34, C36	-	10	CC0603KRX7R0BB104;GRM188R72A104KA35;GCJ188R72A104KA01;HMK107B7104KA06031C104KA72A	YAGEO;MURATA;MURATA;TAIYO YUDEN;AVX	0.1UF	CAPACITOR; SMT (0603); CERAMIC CHIP; 0.1UF; 100V; TOL=10%; TG=-55 DEGC TO +125 DEGC; TC=X7R
	C11, C25	-	2	CC012X752A105K125AB;GRJ21BC72A105KE11;CGA413X752A105K125AB;GRM21BC72A105KE01	TDK;MURATA;TDK	1UF	CAPACITOR; SMT (0805); CERAMIC CHIP; 1UF; 100V; TOL=10%; TG=-55 DEGC TO +125 DEGC; TC=X7S
	C13, C15, C27, C29	-	4	UMK107A87105KA;CC0603KRX7R98B105	TAIYO YUDEN;YAGEO	1UF	CAPACITOR; SMT (0603); CERAMIC CHIP; 1UF; 50V; TOL=10%; TG=-55 DEGC TO +125 DEGC; TC=X7R
	C33, C35, C37	-	3	GRM21BC81E106KE11	MURATA	10UF	CAPACITOR; SMT (0805); CERAMIC CHIP; 10UF; 25V; TOL=10%; TG=-55 DEGC TO +105 DEGC; TC=X6S
	C38	-	1	VJ2220Y332XXUSTX1	VISHAY VITRAMON	3300PF	CAP; SMT (2220); 3300PF; 10%; 250V; X7R; CERAMIC CHIP
	D1	-	1	SMAJ33CA	VISHAY GENERAL SEMICONDUCTOR	33V	DIODE; TVS; SMA (DO-214AC); VRM=33V; IPP=7.5A
	EARTH	-	1	5012	KEYSTONE	N/A	TEST POINT; PIN DIA=0.125IN; TOTAL LENGTH=0.445IN; BOARD HOLE=0.063IN; WHITE; PHOSPHOR BRONZE WIRE SILVER PLATE FINISH;
	FAULTB1_FAULTB2	-	2	LTST-C193KRKT-2A	LITE-ON ELECTRONICS INC.	LTST-C193KRKT-2A	DIODE; LED; EXTRA THIN; EXTRA BRIGHT; RED; SMT (0603); VF=2.2V; IF=0.002A
	GND1_GND_TP1-GND_TP5	-	6	5011	KEYSTONE	N/A	TEST POINT; PIN DIA=0.125IN; TOTAL LENGTH=0.445IN; BOARD HOLE=0.063IN; BLACK; PHOSPHOR BRONZE WIRE SILVER PLATE FINISH;
	J1, J2, J5-J9, J12-J17, J23	-	14	PEC025AAN	SULLINS	PEC025AAN	CONNECTOR; MALE; THROUGH HOLE; BREAKAWAY; STRAIGHT; 2PINS
	J3, J4, J10, J11, J18-J21	-	8	PEC035AAN	SULLINS ELECTRONICS CORP.	PEC035AAN	EVKIT PART-CONNECTOR; MALE; THROUGH HOLE; BREAKAWAY; STRAIGHT; 3PINS; -65 DEGC TO +125 DEGC;
	J22	-	1	PEC045AAN	SULLINS ELECTRONICS CORP.	PEC045AAN	CONNECTOR; MALE; THROUGH HOLE; BREAKAWAY; STRAIGHT; 4PINS
	R1-R8	-	8	CRCW25121K50FKEGHP	VISHAY	1.5K	RES; SMT (2512); 1.5K; 1%; +/-100PPM/DEGC; 1.5W
	R9	-	1	CRCW2512150RKEGHP	VISHAY	150	RES; SMT (2512); 150; 1%; +/-100PPM/DEGC; 1.5W
	R10	-	1	ERJ-3KF7501;CRCW06037K50FK	PANASONIC;VISHAY	7.5K	RESISTOR; 0603; 7.5K OHM; 1%; 100PPM; 0.10W; THICK FILM
	R11, R30	-	2	ERJ-3KF2402	PANASONIC	24K	RESISTOR; 0603; 24K OHM; 1%; 100PPM; 0.10W; THICK FILM
	R12, R13, R43, R44, R63, R69	-	6	CRG0603F10K	TE CONNECTIVITY	10K	RESISTOR; 0603; 10K OHM; 1%; 100PPM; 0.1W; THICK FILM
	R14-R20, R45-R51	-	14	CRCW060320R0FK;ERJ-3KF20R0	VISHAY DALE-PANASONIC	20	RESISTOR; 0603; 20 OHM; 1%; 100PPM; 0.10W; THICK FILM
	R29	-	1	CRCW0603K23FK	VISHAY DALE	5.23K	RESISTOR; 0603; 5.23K OHM; 1%; 100PPM; 0.10W; THICK FILM
	R31-R38	-	8	CRCW25121K00FKEGHP	VISHAY	1K	RES; SMT (2512); 1K; 1%; +/-100PPM/DEGC; 1.5W
	R39-R42	-	4	CRCW2512000Z0EGHP	VISHAY DRALORIC	0	RES; SMT (2512); 0; JUMPER; 1.5W
	R62, R71, R74	-	3	CRCW0603470RFK;ERJ-3KF4700	VISHAY DALE-PANASONIC	470	RESISTOR; 0603; 470 OHM; 1%; 100PPM; 0.10W; THICK FILM
	R72	-	1	ERJ-3KF1603	PANASONIC	160K	RES; SMT (0603); 160K; 1%; +/-100PPM/DEGC; 0.1W
	R73	-	1	CRCW060310K0FK;ERJ-3KF1002	VISHAY DALE-PANASONIC	10K	RESISTOR; 0603; 10K; 1%; 100PPM; 0.10W; THICK FILM
	REFD11, REFD12, REFWB1, REFWB2	-	4	5014	KEYSTONE	N/A	TEST POINT; PIN DIA=0.125IN; TOTAL LENGTH=0.445IN; BOARD HOLE=0.063IN; YELLOW; PHOSPHOR BRONZE WIRE SILVER PLATE FINISH;
	SU1-SU23	-	23	SX1100-B;SX1100-B;STC025VAN	KYCON;KYCON;SULLINS ELECTRONICS CORP.	SX1100-B	TEST POINT; JUMPER; STR; TOTAL LENGTH=0.24IN; BLACK; INSULATION=PBT;PHOSPHOR BRONZE CONTACT=GOLD PLATED
	T1-T4	-	4	250-408	WAGO	250-408	CONNECTOR; FEMALE; THROUGH HOLE; COMPACT TERMINAL STRIP WITH PUSH BUTTON; STRAIGHT; 8PINS
	U1	-	1	MAX22192ARC+	MAXIM	MAX22192ARC+	EVKIT PART - IC; MAX22192ARC+; GGFN70; PACKAGE OUTLINE: 21-100252; PACKAGE CODE: R70610M+1
	U1_IN1-U1_IN8, U2_IN1-U2_IN8	-	16	5125	KEYSTONE	N/A	TEST POINT; PIN DIA=0.125IN; TOTAL LENGTH=0.445IN; BOARD HOLE=0.063IN; BROWN; PHOSPHOR BRONZE WIRE SILVER PLATE FINISH;
	U1_LED1-U1_LED8, U2_LED1-U2_LED8	-	16	LTST-C193KGKT-5A	LITE-ON ELECTRONICS INC.	LTST-C193KGKT-5A	DIODE; LED; STANDARD; YELLOW-GREEN; SMT (0603); PIV=1.9V; IF=0.005A; -55 DEGC TO +85 DEGC
	U2	-	1	MAX22190AT+	MAXIM INTEGRATED	MAX22190AT+	EVKIT PART-IC; OCTAL INDUSTRIAL DIGITAL INPUT WITH DIAGNOSTICS; PACKAGE OUTLINE: 21-0140; PACKAGE CODE: T3255+6; LAND PATTERN NO.: 90-0603; TQFN32-EP
	U3	-	1	MAX12931BASA+	MAXIM	MAX12931BASA+	EVKIT PART - IC; DISO; 1/1 CHANNEL; 25MBPS; DEFAULT HIGH; 3.75KV RMS DIGITAL ISOLATOR; NSOIC8
	U4	-	1	74LVC1G32GW	NEXPERIA	74LVC1G32GW	IC; OR; SINGLE 2-INPUT OR GATE; TSSOP5
	VDD1, VDD2, VDD24, VL, VL2, VUSB	-	6	5010	KEYSTONE	N/A	TEST POINT; PIN DIA=0.125IN; TOTAL LENGTH=0.445IN; BOARD HOLE=0.063IN; RED; PHOSPHOR BRONZE WIRE SIL;
	X1	-	1	TSW-106-08-S-D-RA	SAMTEC	TSW-106-08-S-D-RA	CONNECTOR; THROUGH HOLE; DOUBLE ROW; RIGHT ANGLE; 12PINS;
	X2	-	1	P8C08DAAN	SULLINS ELECTRONICS CORP.	P8C08DAAN	CONNECTOR; MALE; THROUGH HOLE; BREAKAWAY; STRAIGHT; 16PINS; -65 DEGC TO +125 DEGC
	PCB	-	1	MAX22192	MAXIM	PCB	PCB:MAX22192
	MTH1-MTH4	DNI	4	1902B	GENERIC PART	N/A	STANDOFF; FEMALE-THREADED; HEX; 4-40IN; 3/8IN; NYLON
	MTH1-MTH4	DNI	4	P440.375	GENERIC PART	N/A	MACHINE SCREW; SLOTTED; PAN; 4-40IN; 3/8IN; NYLON
	C9	DNI	1	GRM32EC72A106KE05	MURATA	10UF	CAPACITOR; SMT (1210); CERAMIC CHIP; 10UF; 100V; TOL=10%; TG=-55 DEGC TO +125 DEGC; TC=X7S
	C39	DNI	1	GA352QR7GF102KW01	MURATA	1000PF	CAP; SMT (2211); 1000PF; 10%; 250V; X7R; CERAMIC CHIP
	R70	DNI	1	CRCW2512000Z0EGHP	VISHAY DRALORIC	0	RES; SMT (2512); 0; JUMPER; 1.5W
	C1-C8, C16-C23	DNP	0	A37	MURATA;MURATA	1000PF	CAPACITOR; SMT (0402); CERAMIC CHIP; 1000PF; 100V; TOL=10%; TG=-55 DEGC TO +125 DEGC; TC=X7R
	R21-R28, R52-R59	DNP	0	CRCW0603000020	VISHAY DALE	0	RESISTOR; 0603; 0 OHM; 0%; JUMPER; 0.1W; THICK FILM
TOTAL			202				

MAX22192 EV Kit Schematics (continued)

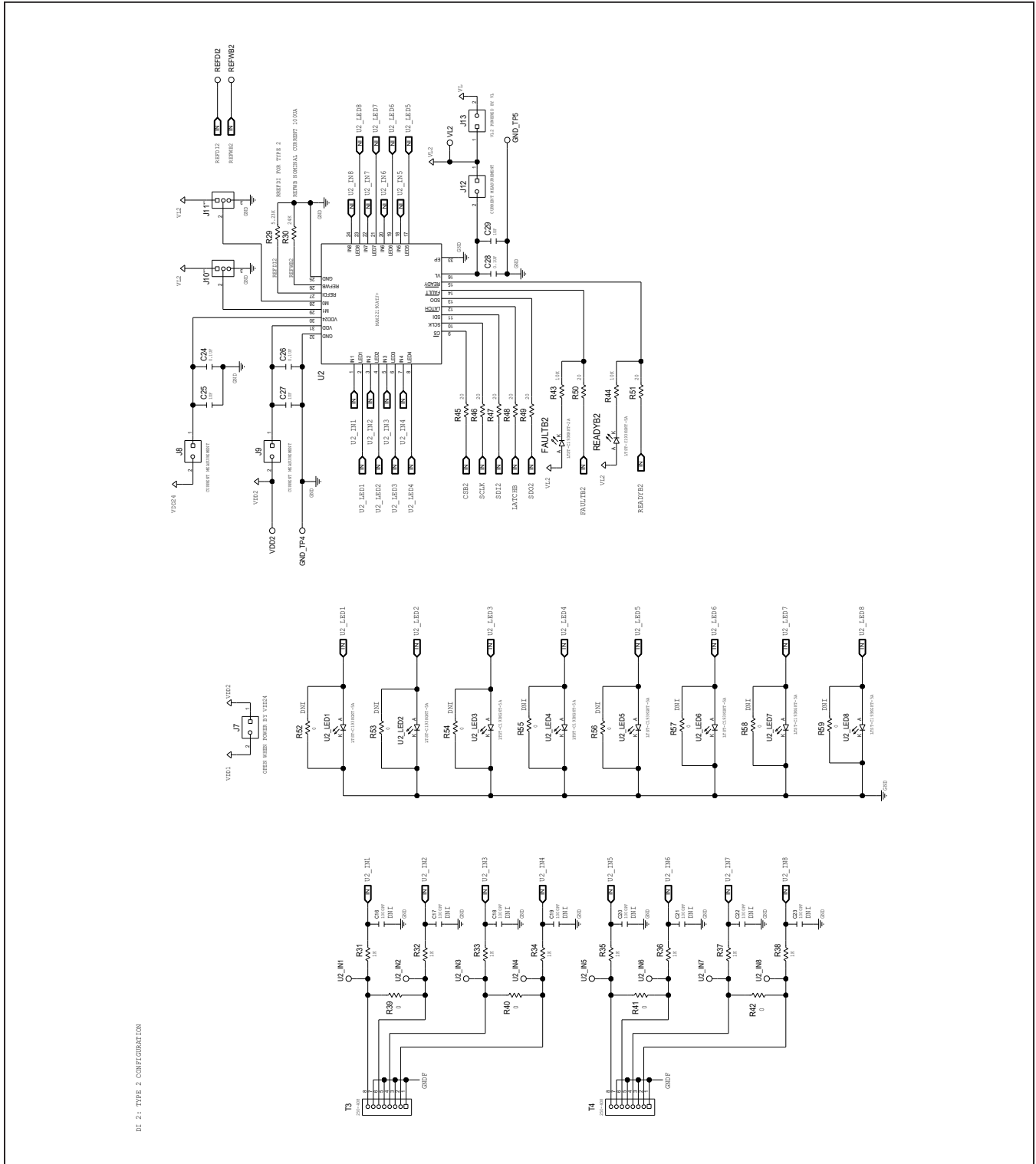

MAX22192 EV Kit Schematics (continued)

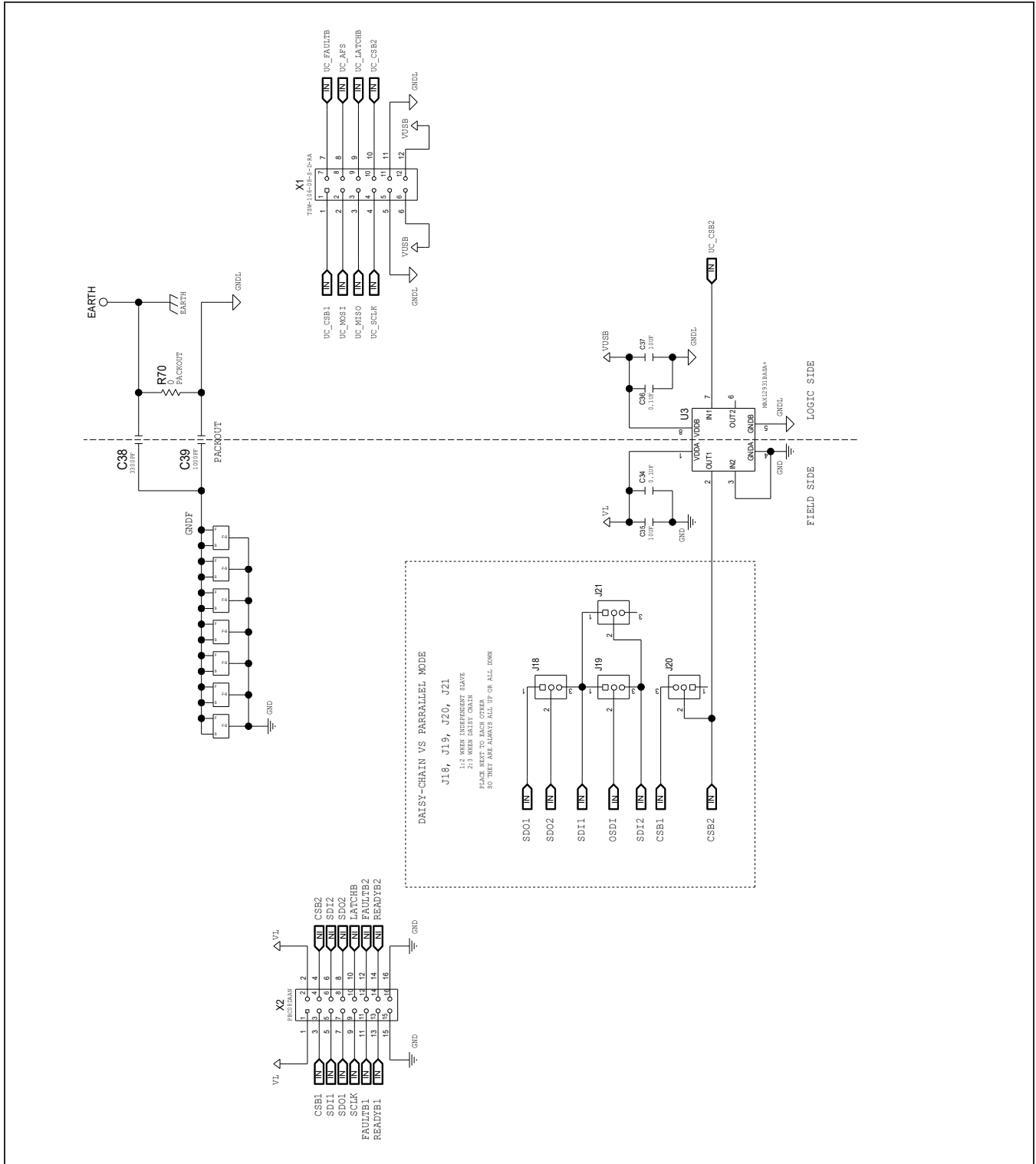

MAX22192 EV Kit PCB Layout (continued)

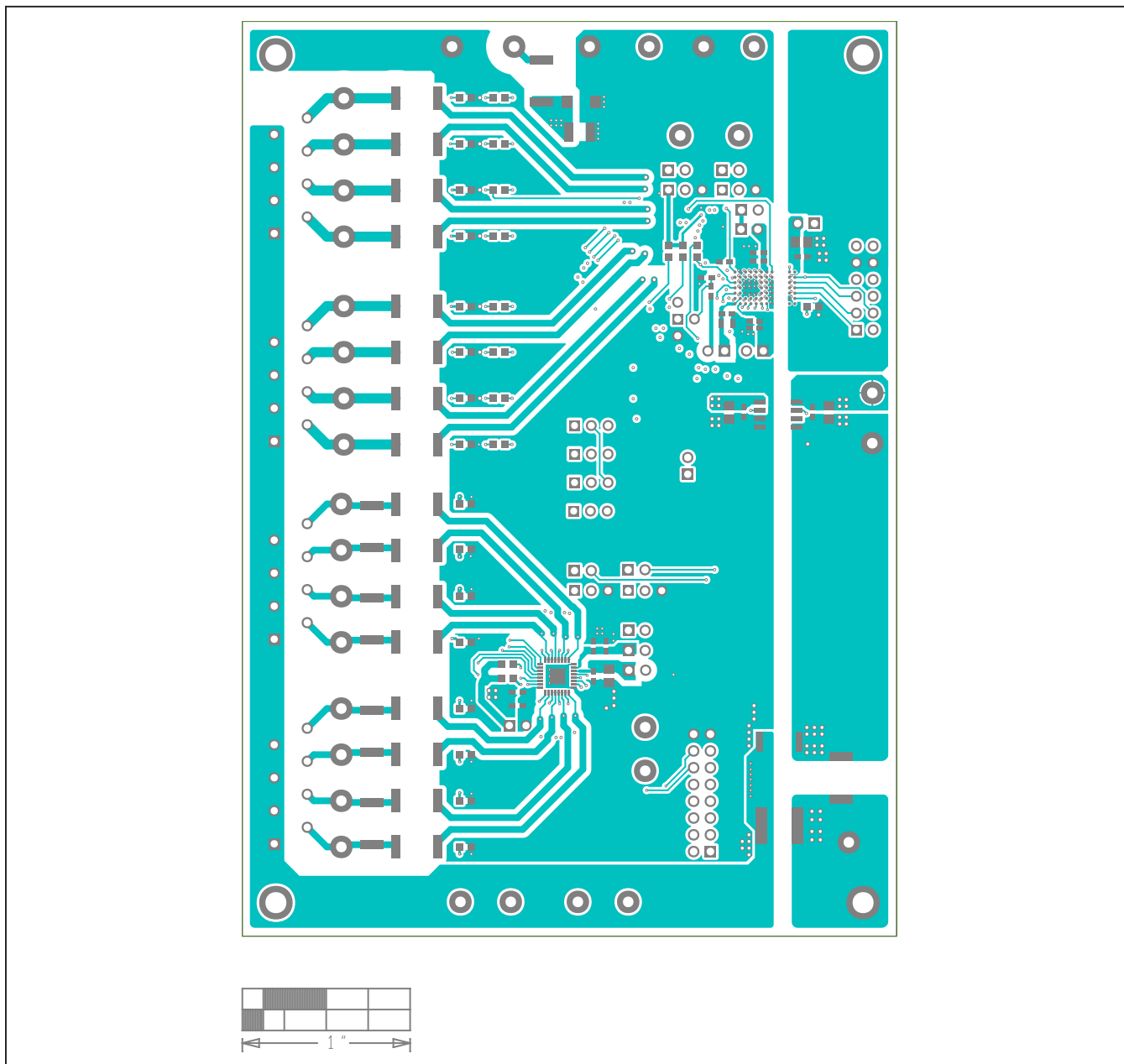

MAX22192 EV Kit—Top

MAX22192 EV Kit PCB Layout (continued)

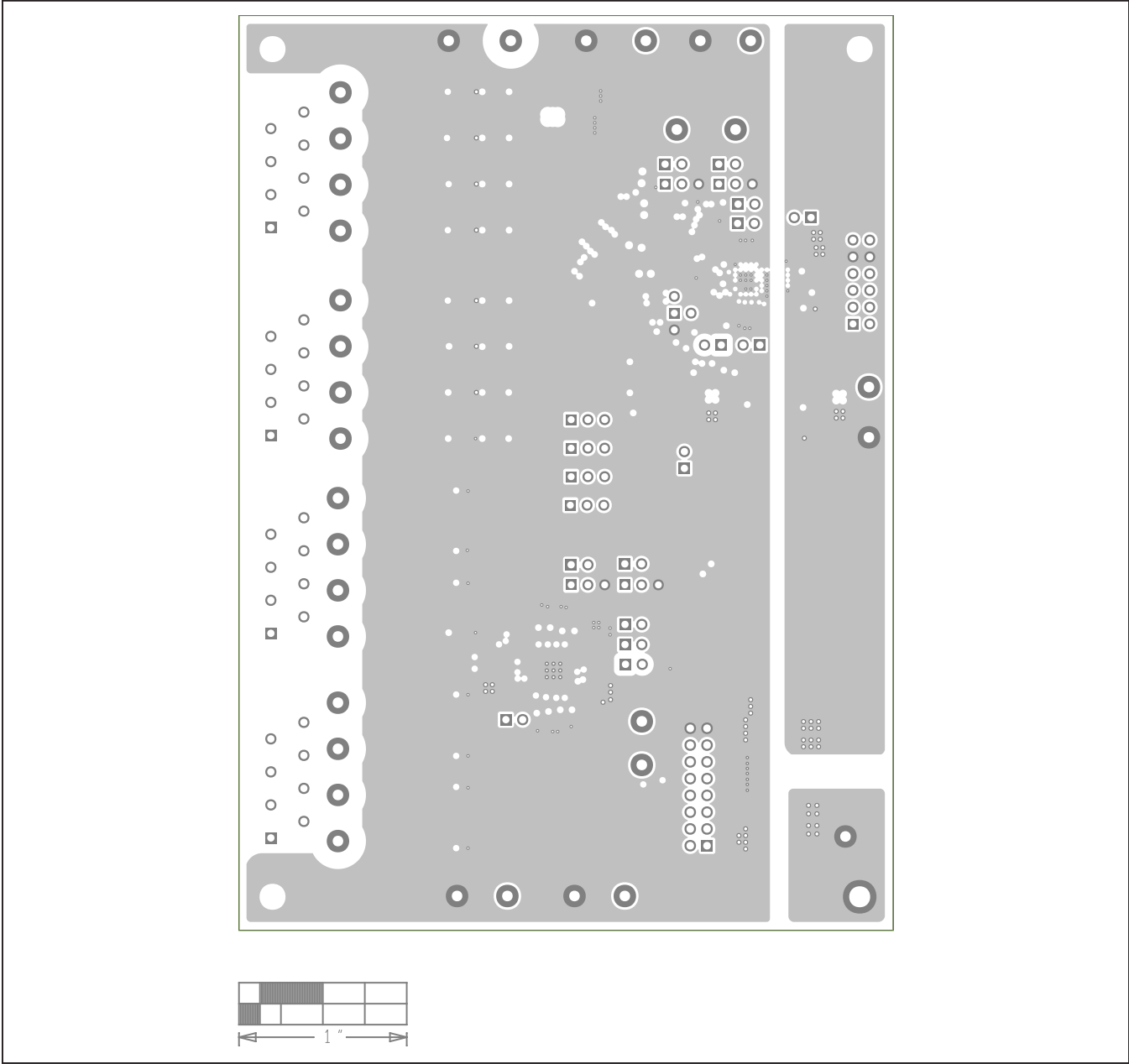

MAX22192 EV Kit—Internal 2

MAX22192 EV Kit PCB Layout (continued)

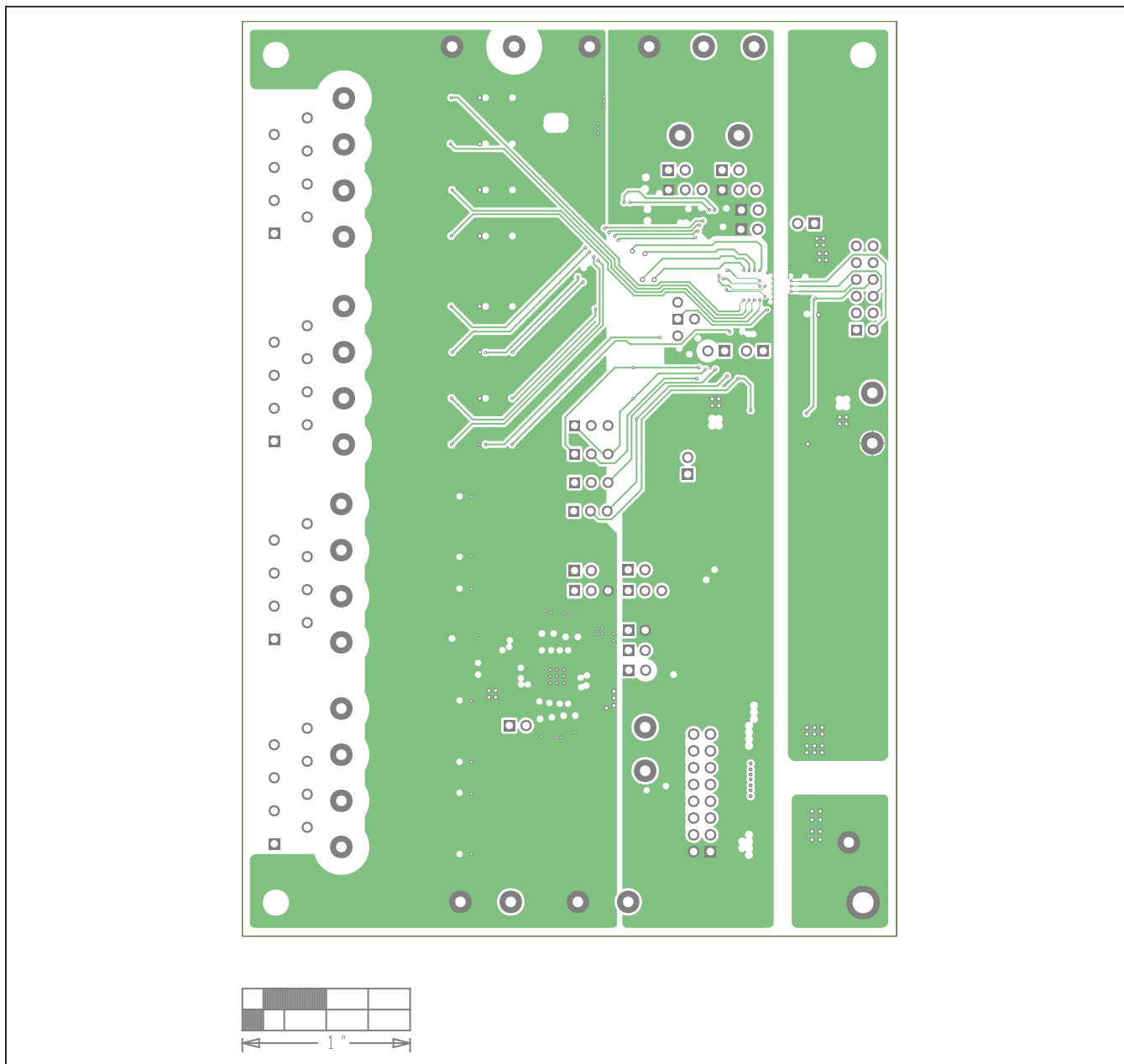

MAX22192 EV Kit—Internal 3

MAX22192 EV Kit PCB Layout (continued)

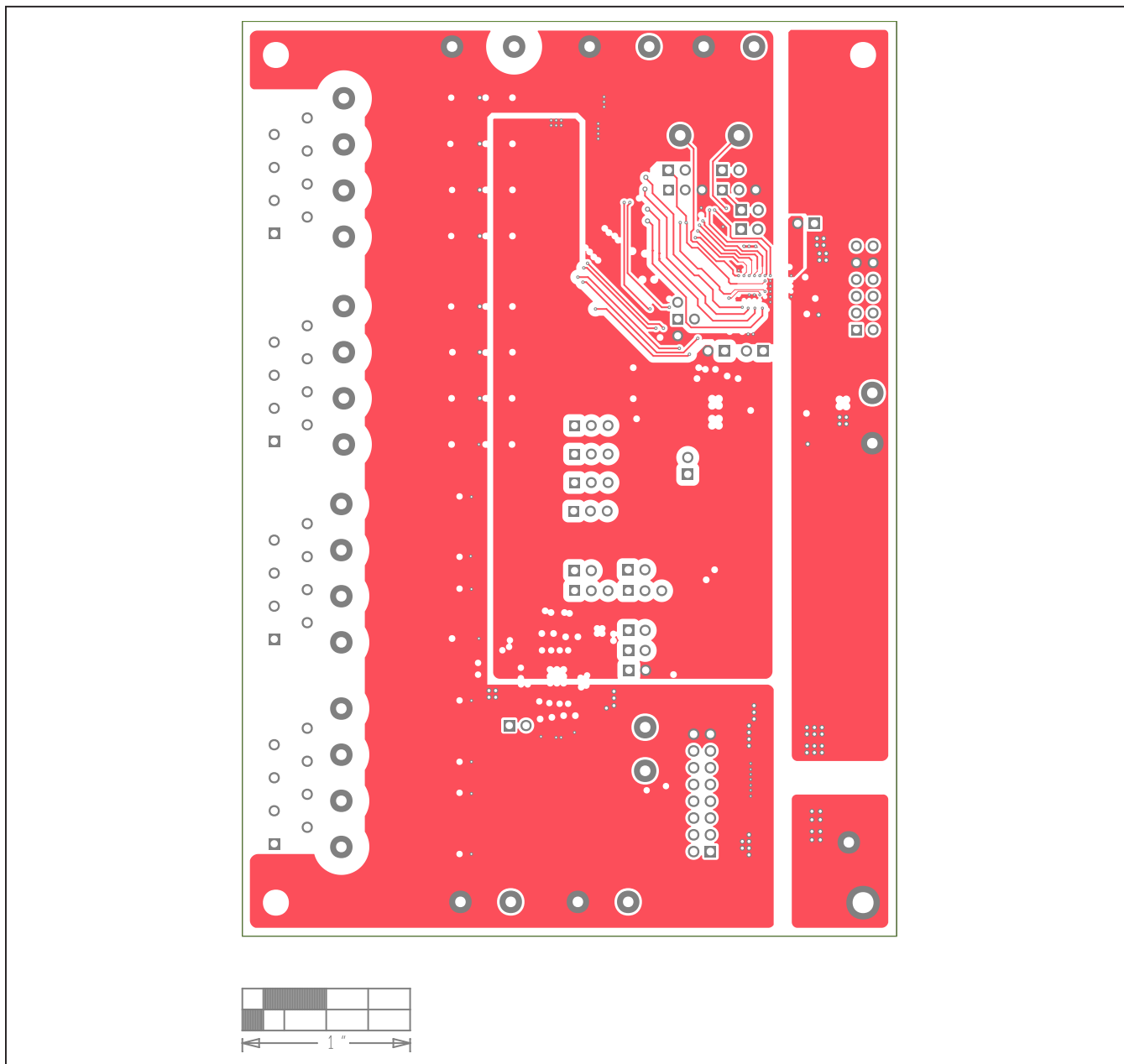

MAX22192 EV Kit—Internal 4

MAX22192 EV Kit PCB Layout (continued)

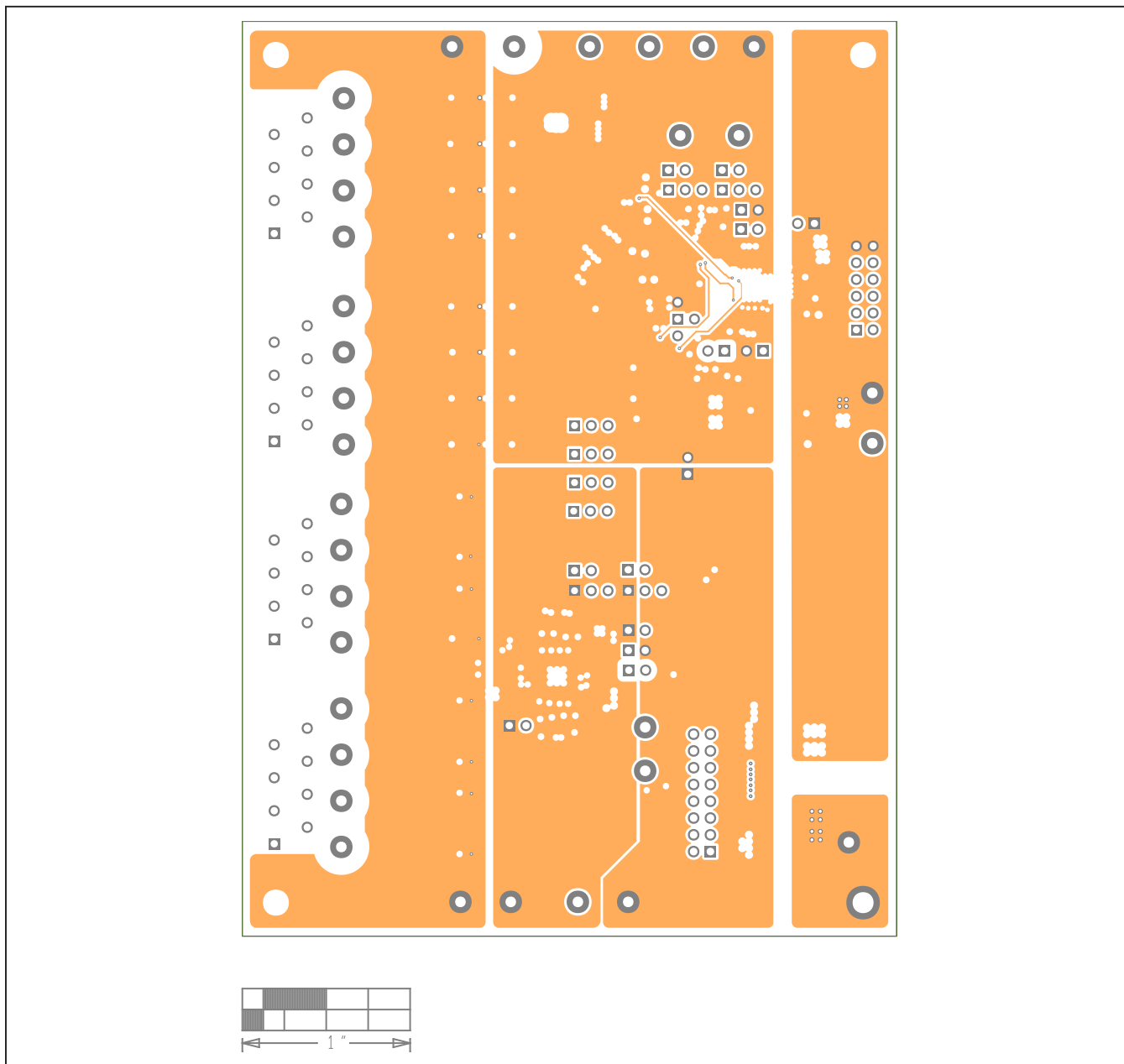

MAX22192 EV Kit—Internal 5

MAX22192 EV Kit PCB Layout (continued)

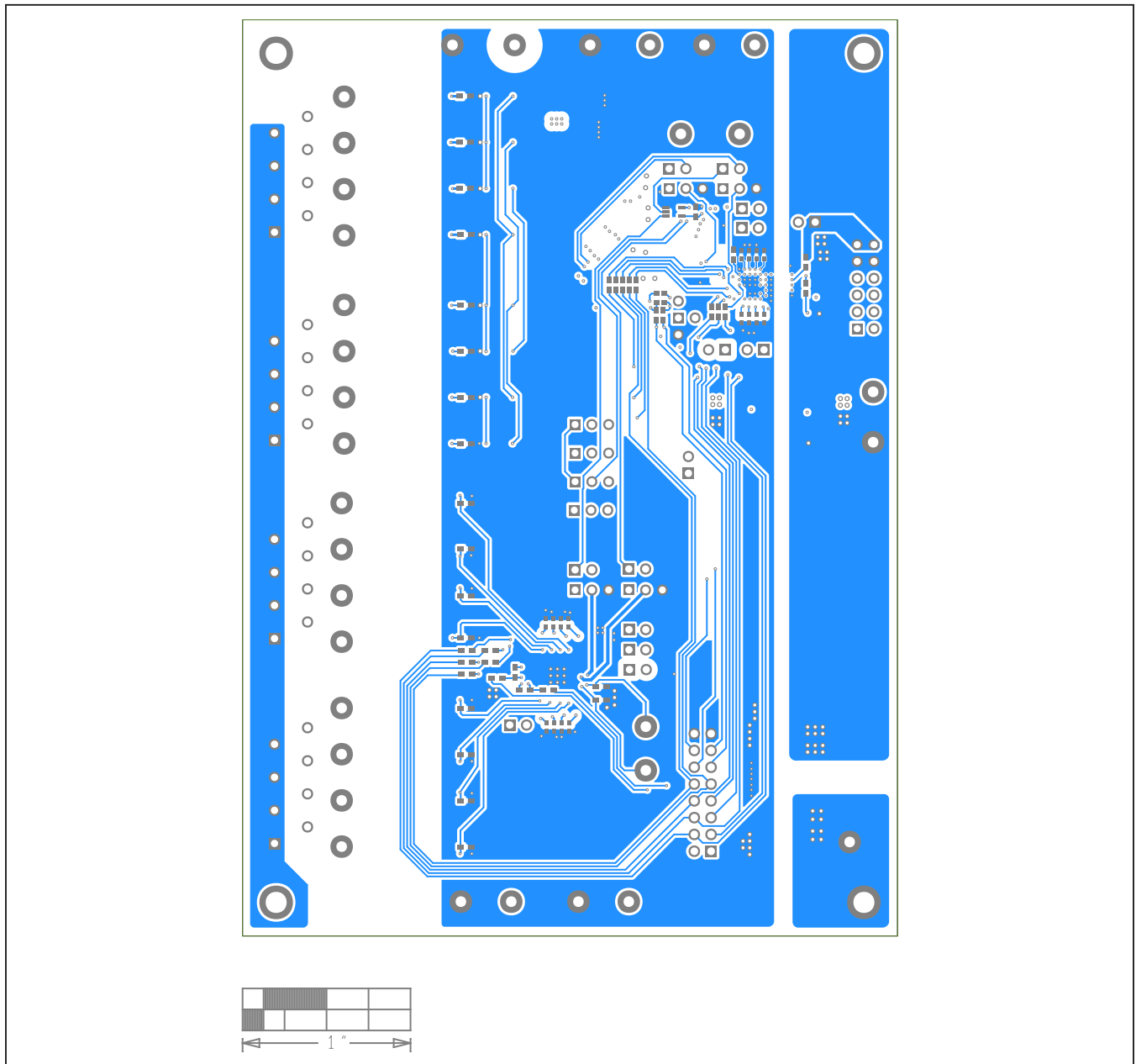

MAX22192 EV Kit—Bottom

MAX22192 EV Kit PCB Layout (continued)

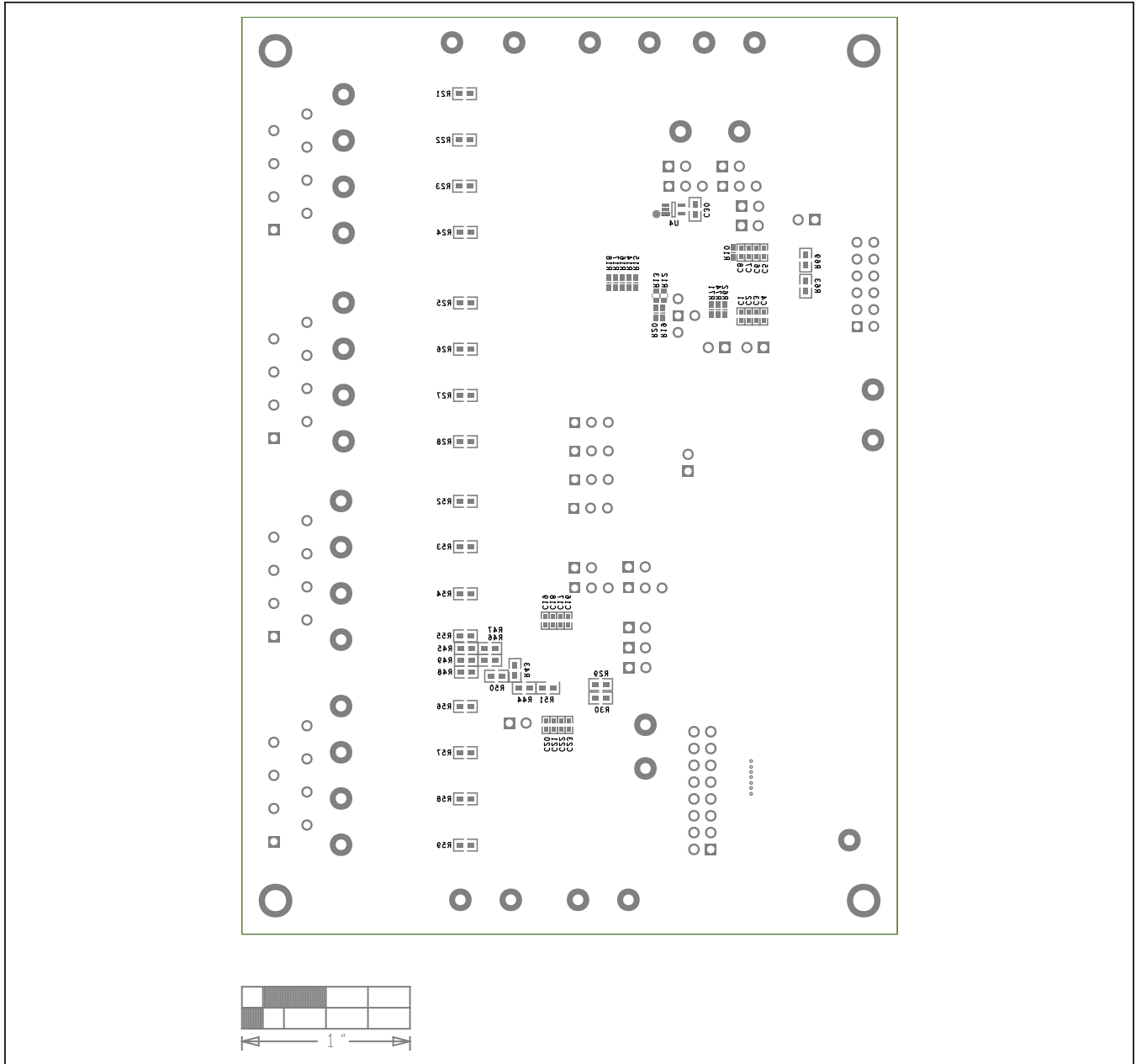

MAX22192 EV Kit—Bottom Silkscreen

Revision History

REVISION NUMBER	REVISION DATE	DESCRIPTION	PAGES CHANGED
0	10/18	Initial release	—
.1		Corrected grammatical error in the <i>Features</i> section	1
2	3/19	Updated the <i>MAX22192 EV Kit Files</i> table and <i>General Description, Procedure, Jumper Setting Diagram, Type 1, 3 Inputs (U1), Type 2 Inputs (U2), and IEC 61000-4 Immunity Compliance</i> sections; added the <i>READY Signal</i> section; replaced the EV Kit and EV System photographs, System Block Diagram, Figure 1, Table 1, Table 2, Figure 7, <i>Bill of Materials, Schematic, and PCB Layout Diagrams</i> ; corrected typo in the <i>General Description</i> section	1–9, 13–28

For pricing, delivery, and ordering information, please visit Maxim Integrated's online storefront at <https://www.maximintegrated.com/en/storefront/storefront.html>.

Maxim Integrated cannot assume responsibility for use of any circuitry other than circuitry entirely embodied in a Maxim Integrated product. No circuit patent licenses are implied. Maxim Integrated reserves the right to change the circuitry and specifications without notice at any time.