

IEC Appliance Inlet with Filter, Fuseholder 1- or 2-pole, Line Switch 2-pole



Protection class I with shield



Protection class II without shield

Order required accessories separately



See below:  
[Approvals and Compliances](#)

**Description**

- Panel mount :  
 Snap-in version from front side
- 4 Functions :  
 Appliance Inlet protection class I or II , Line Switch 2-pole , Fuseholder for fuse-links 5 x 20 mm 1- or 2-pole , Line filter in standard and medical version
- Quick connect terminals 4.8 x 0.8 mm

**Unique Selling Proposition**

- Most compact solution on the market
- Innovative EMC-shielding
- Easy and flexible snap-in mounting
- Protection class I or II versions

**Characteristics**

- Ultra-compact design. Small dimensions in front of and behind the panel
- All single elements are already wired
- For added safety "Extra-Safe" fuse drawers are available
- Innovative EMC-shielding with flexible steel segments for an excellent contact
- Suitable for use in medical equipment according to IEC/UL 60601-1  
 For applications according IEC/UL 62368-1 we recommend variants with bleed resistor

**Other versions on request**

- Fuse drawer 1-pole, plus spare fuse case
- Fuse drawer 2-pole, with shorting bar
- Other rocker marking

**References**

- Alternative: version without line filter [KM](#)
- Alternative: version for screw mounting [DD12](#)

**Weblinks**

[pdf data sheet](#), [html datasheet](#), [General Product Information](#), [Approvals](#), [Distributor-Stock-Check](#), [Accessories](#), [Detailed request for product](#)

**Technical Data**

Ratings IEC	1 - 10A @ Ta 40 °C / 250 VAC; 50Hz	Appliance inlet/-outlet	C14 C18 acc. to IEC 60320-1, UL 498, CSA C22.2 no. 42 (for cold conditions) pin-temperature 70 °C, 10A, Protection Class I or II
Ratings UL/CSA	1 - 10A @ Ta 40 °C / 250 VAC; 60Hz	Fuseholder	1 or 2 pole, Shocksafe category PC2 acc. to IEC 60127-6, for fuse-links 5 x 20mm
Leakage Current	standard < 0.5 mA (250 V / 60 Hz) medical < 5 µA (250 V / 60 Hz)	Rated Power Acceptance @ Ta 23 °C	5 x 20: 2W (1 pole)/ 1.6W (2-pole) per pole
Dielectric Strength	> 1.7 kVDC between L-N > 2.7 kVDC between L/N-PE Test voltage (2 sec)	Power Acceptance @ Ta > 23°C	Admissible power acceptance at higher ambient temperature see derating curves
Allowable Operation Temperature	-25 °C to 85 °C	Line Switch	2-pole, non-illuminated, acc. to IEC 61058-1 <a href="#">Technical Details</a>
Climatic Category	25/085/21 acc. to IEC 60068-1	Line Filter	Standard and Medical Version, IEC 60939, UL 1283, CSA C22.2 no. 8 <a href="#">Technical Details</a>
IP-Protection	from front side IP40 acc. to IEC 60529	MTBF	> 1'800'000h acc. to MIL-HB-217 F
Protection Class	Suitable for appliances with protection class I or II acc. to IEC 61140		
Terminal	Quick connect terminals 4.8 x 0.8 mm		
Panel Thickness S	Snap-in: 1/1.5/2/2.5 mm (all steps with one variant)		
Material: Housing	Thermoplastic, black, UL 94V-0		

**Approvals and Compliances**



Detailed information on product approvals, code requirements, usage instructions and detailed test conditions can be looked up in [Details about Approvals](#)

SCHURTER products are designed for use in industrial environments. They have approvals from independent testing bodies according to national and international standards. Products with specific characteristics and requirements such as required in the automotive sector according to IATF 16949, medical technology according to ISO 13485 or in the aerospace industry can be offered exclusively with customer-specific, individual agreements by SCHURTER.

### Approvals









The approval mark is used by the testing authorities to certify compliance with the safety requirements placed on electronic products.

Approval Reference Type: KMF

Approval Logo	Certificates	Certification Body	Description
	<a href="#">VDE Approvals</a>	VDE	Certificate Number: 40035743
	<a href="#">UL Approvals</a>	UL	UL File Number: E72928
	<a href="#">CQC Approvals</a>	CQC	CQC Certificate Number: CQC18001186843, CQC18001



### Product standards

Product standards that are referenced

Organization	Design	Standard	Description
	Designed according to	IEC 60320-1	Appliance couplers for household and similar general purposes
	Designed according to	IEC 60939	Passive filters for suppressing electromagnetic interference
	Designed according to	IEC 60127-6	Miniature fuses. Part 6. Fuse-holders for miniature fuse-links
	Designed according to	IEC 61058-1	Switches for appliances. Part 1. General requirements
	Designed according to	UL 498	Standard for Attachment Plugs and Receptacles
	Designed according to	UL 1283	Electromagnetic interference filters
	Designed according to	CSA C22.2 no. 42	General Use Receptacles, Attachment Plugs, and Similar Wiring Devices
	Designed according to	CSA C22.2 no. 8	Electromagnetic interference (EMI) filters







### Application standards

Application standards where the product can be used

Organization	Design	Standard	Description
	Designed for applications acc.	IEC/UL 62368-1	IEC 62368-1 includes the basic requirements for safety of audio, video, information technology and office equipment.
	Designed for applications acc.	IEC 60601-1	Medical electrical equipment - Part 1: General requirements for basic safety and essential performance
	Designed for applications acc.	IEC 60335-1	Safety of electrical appliances for household and similar purposes. Meets the requirements for appliances in unattended use. This includes the enhanced requirements of glow wire tests acc. to IEC 60695-2-11 or -12 & -13.

### Compliances

The product complies with following Guide Lines

Identification	Details	Initiator	Description
	<a href="#">CE declaration of conformity</a>	SCHURTER AG	The CE marking declares that the product complies with the applicable requirements laid down in the harmonisation of Community legislation on its affixing in accordance with EU Regulation 765/2008.
	RoHS	SCHURTER AG	Directive RoHS 2011/65/EU, Amendment (EU) 2015/863
	China RoHS	SCHURTER AG	The law SJ / T 11363-2006 (China RoHS) has been in force since 1 March 2007. It is similar to the EU directive RoHS.
	REACH	SCHURTER AG	On 1 June 2007, Regulation (EC) No 1907/2006 on the Registration, Evaluation, Authorization and Restriction of Chemicals 1 (abbreviated as "REACH") entered into force.
	White Paper Glow wire test	SCHURTER AG	Meets the requirements of IEC 60335-1 for appliances in unattended use. This includes the enhanced requirements of glow wire tests acc. to IEC 60695-2-11 or -12 &-13.
	Medical Technology	SCHURTER AG	Suitable for use in medical equipment according to IEC/UL 60601-1

### Dimensions [mm]

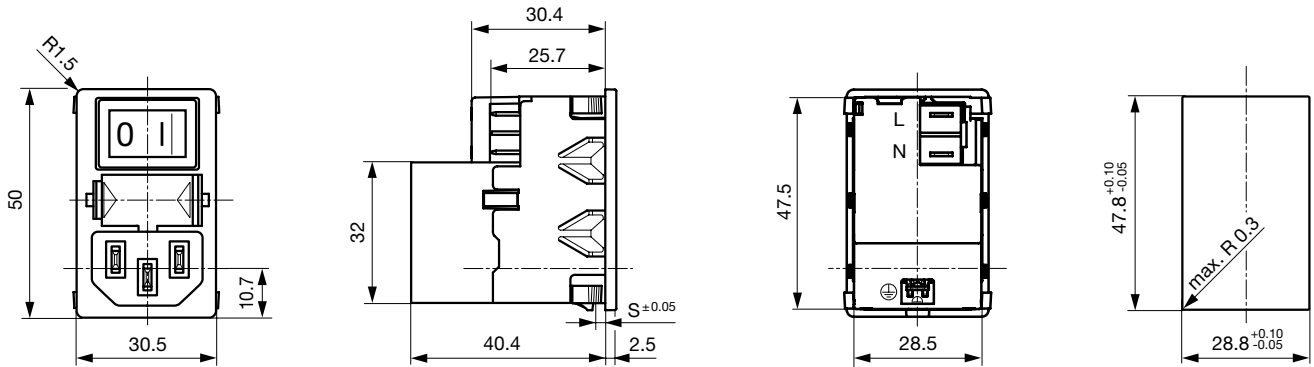

### Technical Data of Filter-Components

Rated Current [A]	Filter-Type	Inductances L [mH]	Capacitance CX [nF]	Capacitance CY [nF]	R [MΩ]
1	Standard version	2 x 11	47	2.2	-
2	Standard version	2 x 4	47	2.2	-
4	Standard version	2 x 1.6	47	2.2	-
6	Standard version	2 x 0.7	47	2.2	-
10	Standard version	2 x 0.4	47	2.2	-
1	Medical Version (M5)	2 x 11	47	-	1
2	Medical Version (M5)	2 x 4	47	-	1
4	Medical Version (M5)	2 x 1.6	47	-	1
6	Medical Version (M5)	2 x 0.7	47	-	1
10	Medical Version (M5)	2 x 0.4	47	-	1

Diagrams

Standard version

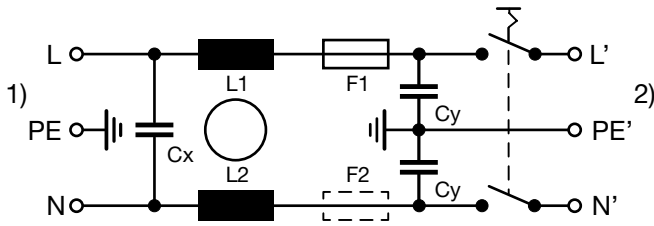

1) Line  
 2) Load

Medical Version (M5)

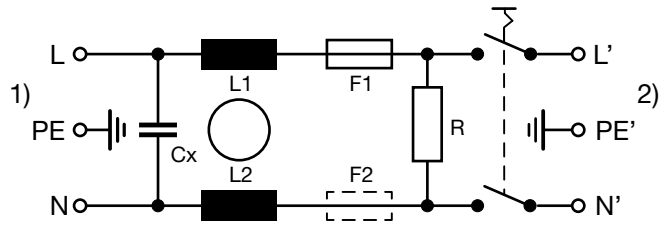

1) Line  
 2) Load

Medicalversion (M5), Protection Class II

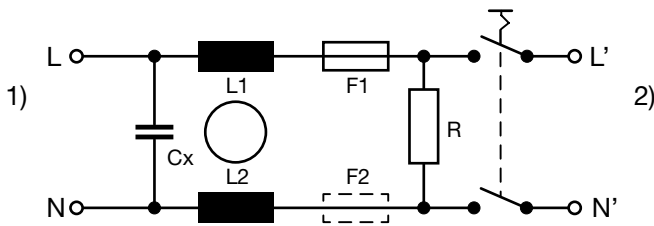

1) Line  
 2) Load

Derating Curves

1-pole

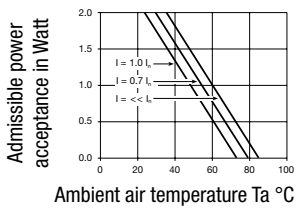

2-pole

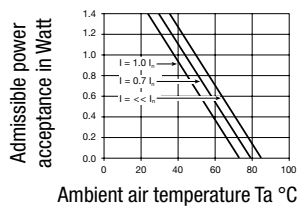

Attenuation Loss

--- 50Ω differential mode \_\_\_\_ 50Ω common mode

Standard version

1 A

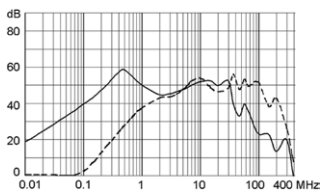

2 A

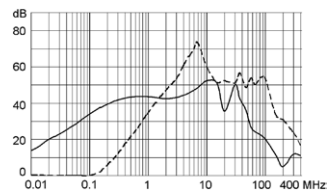

4 A

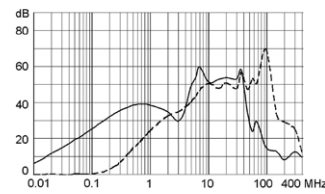

6 A

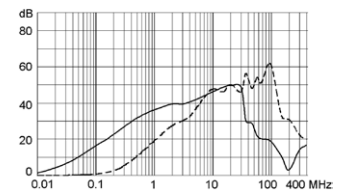

10 A

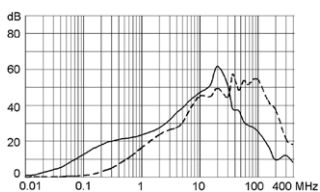

Medical version (M5)

1 A

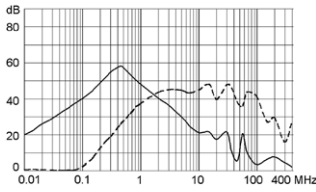

2 A

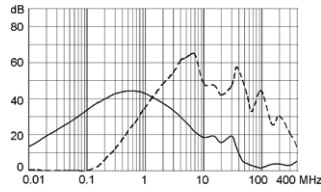

4 A

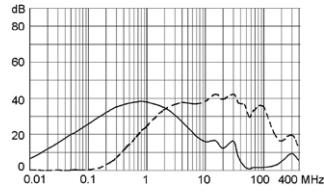

6 A

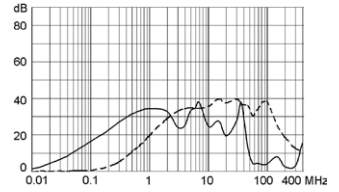

10 A

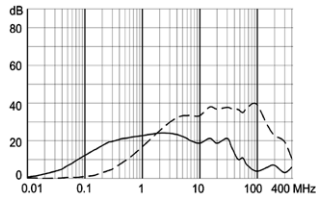

All Variants

Rated Current [A]	Filter-Type	Fuseholder	Line Switch	Protection Class	Order Number
1	Standard version	1-pole	2-pole	I	<a href="#">KMF1.1211.11</a>
2	Standard version	1-pole	2-pole	I	<a href="#">KMF1.1221.11</a>
4	Standard version	1-pole	2-pole	I	<a href="#">KMF1.1241.11</a>
6	Standard version	1-pole	2-pole	I	<a href="#">KMF1.1261.11</a>
10	Standard version	1-pole	2-pole	I	<a href="#">KMF1.1291.11</a>
1	Standard version	2-pole	2-pole	I	<a href="#">KMF1.1111.11</a>
2	Standard version	2-pole	2-pole	I	<a href="#">KMF1.1121.11</a>
4	Standard version	2-pole	2-pole	I	<a href="#">KMF1.1141.11</a>
6	Standard version	2-pole	2-pole	I	<a href="#">KMF1.1161.11</a>
10	Standard version	2-pole	2-pole	I	<a href="#">KMF1.1191.11</a>
1	Medical Version (M5)	1-pole	2-pole	I	<a href="#">KMF1.1213.11</a>
2	Medical Version (M5)	1-pole	2-pole	I	<a href="#">KMF1.1223.11</a>
4	Medical Version (M5)	1-pole	2-pole	I	<a href="#">KMF1.1243.11</a>
6	Medical Version (M5)	1-pole	2-pole	I	<a href="#">KMF1.1263.11</a>
10	Medical Version (M5)	1-pole	2-pole	II	<a href="#">KMF0.2293.11</a>
10	Medical Version (M5)	1-pole	2-pole	I	<a href="#">KMF1.1293.11</a>
1	Medical Version (M5)	2-pole	2-pole	II	<a href="#">KMF0.2113.11</a>
1	Medical Version (M5)	2-pole	2-pole	I	<a href="#">KMF1.1113.11</a>
2	Medical Version (M5)	2-pole	2-pole	II	<a href="#">KMF0.2123.11</a>
2	Medical Version (M5)	2-pole	2-pole	I	<a href="#">KMF1.1123.11</a>
4	Medical Version (M5)	2-pole	2-pole	II	<a href="#">KMF0.2143.11</a>
4	Medical Version (M5)	2-pole	2-pole	I	<a href="#">KMF1.1143.11</a>
6	Medical Version (M5)	2-pole	2-pole	II	<a href="#">KMF0.2163.11</a>
6	Medical Version (M5)	2-pole	2-pole	I	<a href="#">KMF1.1163.11</a>
10	Medical Version (M5)	2-pole	2-pole	II	<a href="#">KMF0.2193.11</a>
10	Medical Version (M5)	2-pole	2-pole	I	<a href="#">KMF1.1193.11</a>

Most Popular.

Availability for all products can be searched real-time: <https://www.schurter.com/en/Stock-Check/Stock-Check-SCHURTER>

Packaging unit 20 Pcs

Required Accessory



Description

Fusedrawer 2

Fusedrawer für Fuse Links 5x20 mm, with or without Voltage Selector Insert

Fingergrip, 2-pole	4301.1401
Extra-Safe, 2-pole	4301.1403
Fingergrip, 1-pole	4301.1405
Extra-Safe, 1-pole	4301.1407

...

Accessories



Wire Harness

Wire harness for SCHURTER products

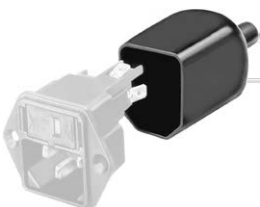

Assorted Covers

Rear Cover

0859.0076



Cord retaining kits

Cord retaining strain relief

Flat head, A	4700.0001
--------------	-----------

Mating Outlets/Connectors

Category / Description

Appliance Outlet Overview complete



4787, Mounting: Screw-on mounting, Appliance Outlet: IEC Solder terminals, 10 A, Suitable for appliances with protection class I	4787
--	------

4788, Mounting: Snap-in version, Appliance Outlet: IEC Solder terminals or quick connect terminals, 10 A, Suitable for appliances with protection class I	4788
---	------

IEC Appliance Outlet F or H, Screw-on Mounting, Front Side, Solder, PCB or Quick-connect Terminal	5091
---	------

Appliance Outlet further types to KMF

Connector Overview complete



4782 Mounting: Power Cord, 3 x 1 mm <sup>2</sup> / 3 x 18 AWG, Cable, Connector: IEC C13	4782
--	------

4785 Mounting: Power Cord, 3 x 1 mm <sup>2</sup> / 3 x 18 AWG, Cable, Connector: IEC C13	4785
--	------

4012 Mounting: Power Supply Cord, 3 x 1 mm <sup>2</sup> , Screw clamps, Connector: IEC C13	4012
--	------

4300-06 Mounting: Power Cord, 3 x 1 mm <sup>2</sup> / 3 x 18 AWG, Cable, Connector: IEC C13	4300-06
---	---------

4781 Mounting: Power Cord, 3 x 1 mm <sup>2</sup> / 3 x 18 AWG, Cable, Connector: IEC C15	4781
--	------

Connector further types to KMF

...