

ITEM	QTY	PART NUMBER	PART DESCRIPTION
1	1	LPRX-XXX-XXX	Surface Mount Right Angle Light Pipe, 2.8mm, 4 Station. See Table on 2nd Page
2	1	RLPHX-XXX	LPR Housing, 4 Station, White. See Table on 2nd Page

REV.	DESCRIPTION	DATE	APPROVED
A	Engineering Release	11/06/09	T. Y.
B	Added Overall Height "K" Dim	03/04/11	T. Y.
C	Added Overall Snap Height Dimension	08/15/12	T. Y.
D	Added Color Options, Sheet #3	02/02/16	J. C.

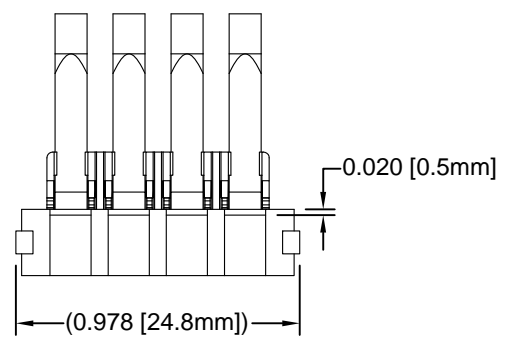
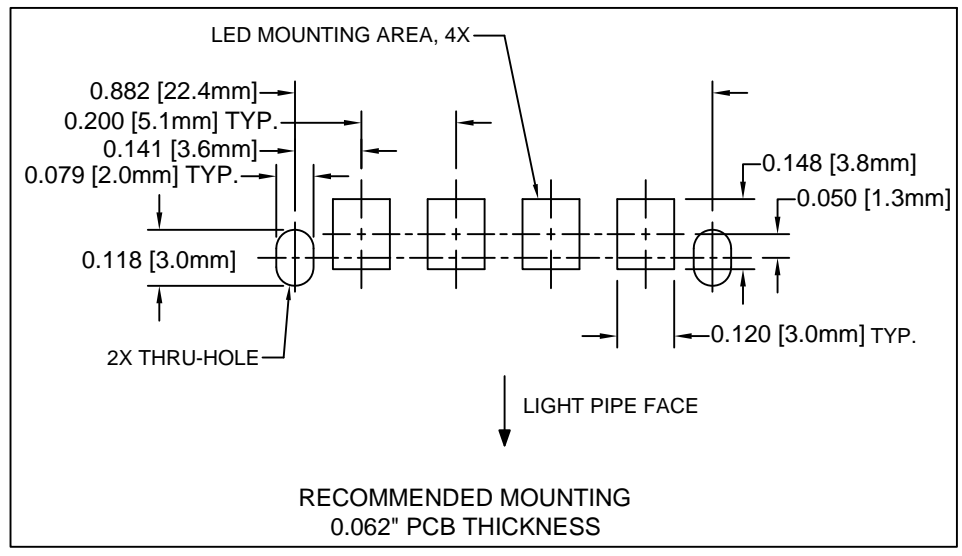
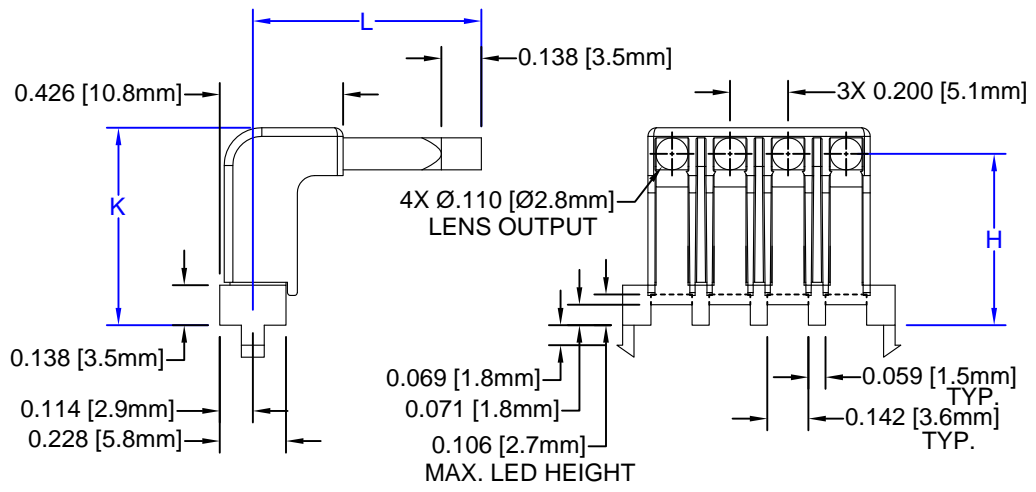
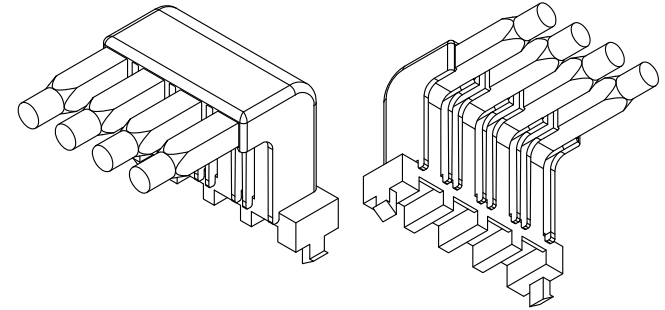
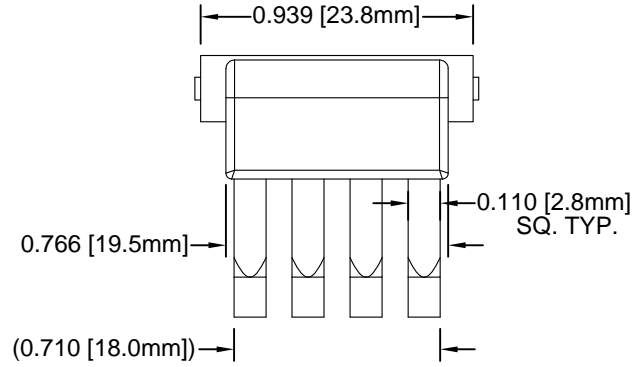

STANDARD TOLERANCE (UNLESS OTHERWISE SPECIFIED)		BIVAR®	
DECIMALS	ANGULAR	4 THOMAS, IRVINE, CA. 92618	
.X ± .1	X° ± 1°	TEL: (949) 951-8808 FAX: (949) 951-3974	
.XX ± .01		TITLE: RIGHT ANGLE LIGHT PIPE, 2.8MM, 4 STATION	
.XXX ± .010		PART NO: RLP4-XXX-XXX	
DESIGNED: Raffy Paje	DATE: 11/06/09	REVISION: D	
CHECKED: T. Yin	DATE: 11/06/09	CAGE CODE : 32559 SHEET # 1 OF 3	
CAD GENERATED DOCUMENT. DO NOT MEASURE DRAWING.			

REV.	DESCRIPTION	DATE	APPROVED
	SEE SHEET #1		

RLP4-XXX-XXX						
ASSY P/N	H	L	K	LPR4-XXX-XXX	RLPH4-XXX	FIGURE
RLP4-200-500	0.197 [5.0mm]	0.551 [14.0mm]	0.287 [7.3mm]	LPR4-200-500	RLPH4-200	
RLP4-200-650		0.669 [17.0mm]		LPR4-200-650	RLPH4-200	
RLP4-200-800		0.787 [20.0mm]		LPR4-200-800	RLPH4-200	
RLP4-400-500	0.394 [10.0mm]	0.551 [14.0mm]	0.484 [12.3mm]	LPR4-400-500	RLPH4-400	
RLP4-400-650		0.669 [17.0mm]		LPR4-400-650	RLPH4-400	
RLP4-400-800		0.787 [20.0mm]		LPR4-400-800	RPH4-400	
RLP4-600-500	0.591 [15.0mm]	0.551 [14.0mm]	0.681 [17.3mm]	LPR4-600-500	RLPH4-600	
RLP4-600-650		0.669 [17.0mm]		LPR4-600-650	RLPH4-600	
RLP4-600-800		0.787 [20.0mm]		LPR4-600-800	RLPH4-600	

STANDARD TOLERANCE (UNLESS OTHERWISE SPECIFIED)		 BIVAR [®] 4 THOMAS, IRVINE, CA. 92618 TEL: (949) 951-8808 FAX: (949) 951-3974	
DECIMALS	ANGULAR		
.X ± .1	X° ± 1°	 TITLE: RIGHT ANGLE LIGHT PIPE, 2.8MM, 4 STATION	
.XX ± .01			
.XXX ± .010		PART NO: RLP4-XXX-XXX	
DESIGNED: Raffy Paje	DATE: 11/06/09	REVISION: D	
CHECKED: T. Yin	DATE: 11/06/09	CAGE CODE : 32559	
		SHEET # 2 OF 3 <small>CAD GENERATED DOCUMENT. DO NOT MEASURE DRAWING.</small>	

OTHER AVAILABLE COLORS

* SEE TABLE FOR ORDERING INFORMATION

REV.	DESCRIPTION	DATE	APPROVED
	SEE SHEET #1		

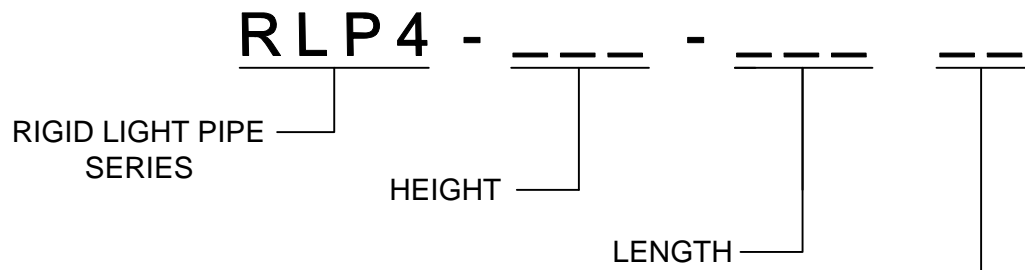

COLOR	Order Code
BLUE	BE
BLACK	BK
GREEN	GN
GRAY	GY
RED	RD
YELLOW	YW

NOTE: LEAVE ORDER CODE BLANK IF NO COLOR IS DESIRED.

- 2. ONLY LIGHT PIPES OF ASSEMBLIES WILL BE DYED.
- 1. PARTS ARE DYED TO COLOR UPON REQUEST.

STANDARD TOLERANCE (UNLESS OTHERWISE SPECIFIED) DECIMALS ANGULAR		 4 THOMAS, IRVINE, CA. 92618 TEL: (949) 951-8808 FAX: (949) 951-3974	
			
DESIGNED: K. Aukshunas	DATE: 01/25/16	TITLE: RIGHT ANGLE LIGHT PIPE, 2.8MM, 4 STATION	
CHECKED: J. Chiang	DATE: 01/25/16	PART NO: RLP4-XXX-XXX	REVISION: D
		CAGE CODE : 32559	SHEET # 3 OF 3
CAD GENERATED DOCUMENT. DO NOT MEASURE DRAWING.			