

Box Cover Units

For Plug Fuses

Plug fuse box cover units provide a simple, inexpensive way to protect small motors with Edison-type “T”, “TL”, “TC”, “P” and “W” plug fuses. Box cover units are easily installed in standard electrical boxes. By using fuses sized at the amp rating of a motor or slightly larger, optimum overload and short-circuit protection is provided. Box cover units are UL Listed.

Selection Data – Plug Fuse Box Cover Units

Box Cover Cat. No.	Type Box	Fuseholder		Receptacle Outlet to Load		Switch Control+	Switch Light++	Motor Size (Max.)	General Data	Agency† Listing/ Certification	
		Single	Double	125Vac	250Vac						
SOU	2 1/4" Handy	X						3/4 Hp	125V, 15A	UL, CSA	
SRU		X		X				1/2 Hp	125V, 15A	UL	
SSU		X					X		1/2 Hp	125Vac (do not use on DC), 15A	UL, CSA
SOW	2 3/4" Switch	X						3/4 Hp	125V, 15A	UL, CSA	
SRW		X		X				1/2 Hp	125V, 15A	UL	
SSW		X					X		1/2 Hp	125Vac (do not use on DC), 15A	UL, CSA
SOX	4" Octagon	X						3/4 Hp	125V, 15A	UL, CSA	
SRX		X		X				1/2 Hp	125V, 15A	UL	
SSX		X					X		1/2 Hp	125Vac (do not use on DC), 15A	UL, CSA
SOY	4" Square	X						3/4 Hp	125V, 15A	UL, CSA	
SRY		X		X				1/2 Hp	125V, 15A	UL	
SSY		X					X		1/2 Hp	125Vac (do not use on DC), 15A	UL, CSA
SSY-RL		X		X			X	X	1/2 Hp	125Vac (do not use on DC), 15A	—
STY*				X			X*		1/2 Hp*	125Vac (do not use on DC)*, 15A	UL
SCY**			X			X(2)**		1/2 Hp(2)**	125Vac (do not use on DC); can protect two motors**, 15A	UL	
SOY-B			X					3/4 Hp	125V, protects two motors, 15A	UL	
SKA	4 1/8" Square		X					2 Hp	250V, 15A single-phase	UL	
SSN	Single Gang	X				X		1/2 Hp	125V, 15A Weatherproof	UL	

+ Switch turns power to fused load OFF or ON.

++ Switch light indicates power to load (dark when switch OFF or fuse open).

* Double-pole switch opens both sides of circuit. STY can be used for two separate 125V motors not larger than 1/2 Hp with the common switch, or a single motor not larger than 2 Hp at 250V (Maximum of 150V to ground).

** The SCY unit can be used for protection of a single motor not larger than 2Hp at 250V (Maximum of 150V to ground).

† UL Guide JAMZ, File E6491; CSA Class 6225-01, File 47235.

2 1/4" Handy Boxes

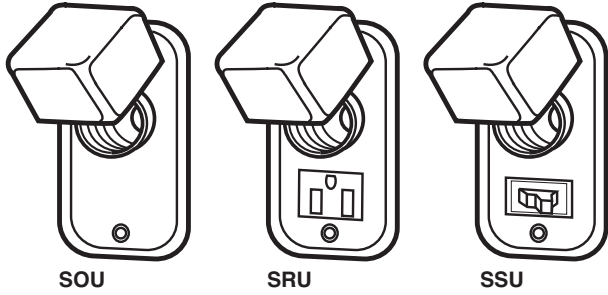

2 3/4" Switch Boxes

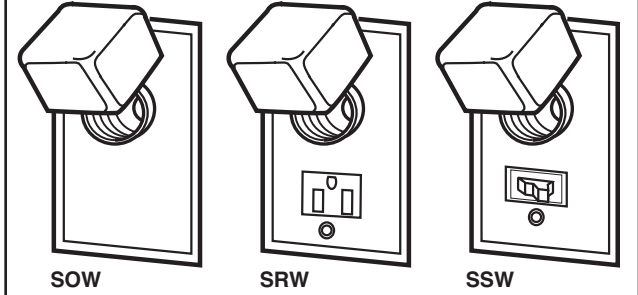

4" Octagon Boxes

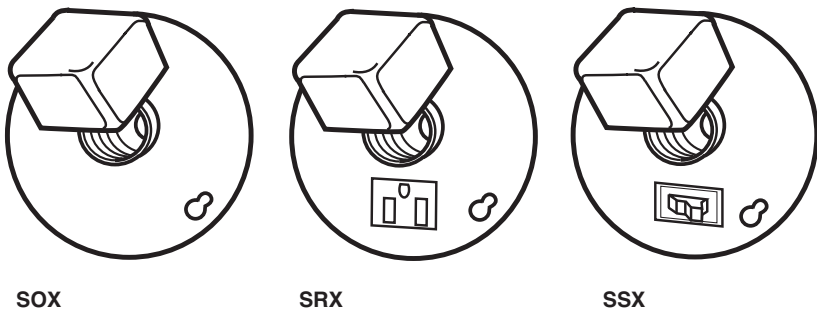

4-1/16" Square Boxes

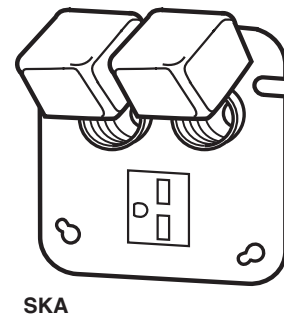

4" Square Boxes

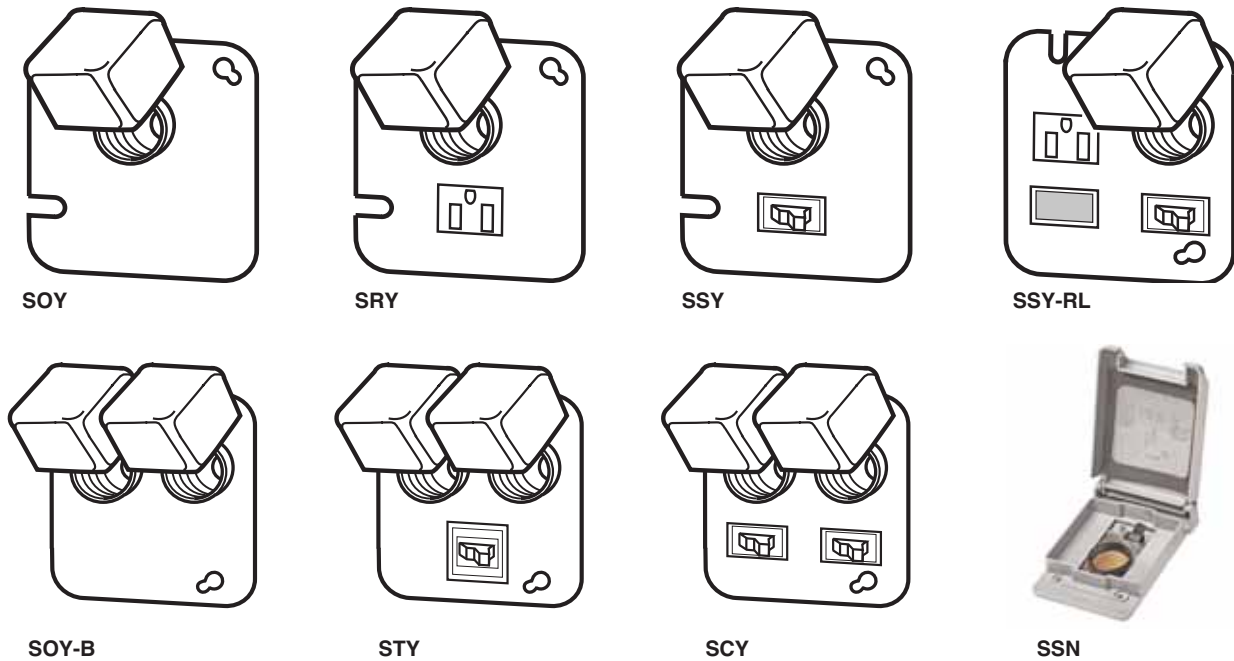

UL/CSA Fuses
Current Limiting

UL/CSA Fuses
General Purpose

Special
Purpose Fuses

Canadian
Fuses & Holders

Medium
Voltage Fuses

Fuse Blocks,
Holders & Misc.

Application
Section