



ACC600 Series

Convection Cooled Open Frame Power Supplies

The ACC600 Series of open frame power supplies feature a wide universal AC input range of 85 – 264 VAC, offering up to 600 W of output power with convection cooling (U-Channel), in a compact footprint, with a variety of single output voltages.

The high efficiency and high power density of the ACC series ensures minimal power loss in end-use equipment, thereby facilitating higher reliability, easier thermal management and meets regulatory approvals for environmentally-friendly end products.

These power supplies are ideal for medical, telecom, datacom, industrial equipment and other applications.



Key Features & Benefits

- 5 x 8.5 x 1.61 Inch Form Factor (127 x 216 x 41 mm)
- Convection Cooling Rated
- Universal Input
- Current Sharing Option
- Peak Power Capability
- 5 VDC Stand by
- 12 V fan output
- Power Good / Power Fail Signal
- Suitable in POE applications
- Lesser than 1U high
- Having high voltage output range up to 58 VDC
- N+1 redundant power supply
- Single wire current sharing
- Built in OR-ing diode / FET (- R suffix)

Applications

- Instrumentation
- Lighting
- Industrial Applications
- Applied Computing
- Renewable Energy
- Test and Measurement
- Robotics
- Wireless Communication



bel POWER SOLUTIONS & PROTECTION

a bel group

belfuse.com/power-solutions

1. MODEL SELECTION

MODEL NUMBER*	VOLTAGE	TYPE	MAX. LOAD (CONVECTION)	MIN. LOAD	RIPPLE & NOISE
ACC600-1T12	12 V	U-Channel	25 A	0.0 A	2%
ACC600-1T15	15 V	U-Channel	25 A	0.0 A	2%
ACC600-1T24	24 V	U-Channel	25 A	0.0 A	2%
ACC600-1T30	30 V	U-Channel	20 A	0.0 A	2%
ACC600-1T48	48 V	U-Channel	12.5 A	0.0 A	2%
ACC600-1T58	58 V	U-Channel	10.34 A	0.0 A	2%

* To order product without the redundancy diode option please add the suffix-Sxxx to your required part number. Please contact the factory for availability.

2. INPUT SPECIFICATIONS

Specifications are for nominal input voltage, 25°C unless otherwise stated.

PARAMETER	DESCRIPTION / CONDITION	SPECIFICATION
Input Voltage	Universal	85 – 264 VAC / 120 – 390 VDC
Input Frequency		47 – 63 Hz
Input Current	120 VAC: 240 VAC:	6.5 A max. 3.2 A max.
Input Protection	In Live & Neutral both	F16 A / 250 V
No Load Power	Over entire input range with main output kept OFF using Remote ON/OFF	3 W typ.
Inrush Current	240 VAC:	25 A max.
Leakage Current	240 VAC / 50 Hz	400 µA
Touch Current:		< 100 µA
Power Factor	120 VAC: 240 VAC:	0.98 0.95
Switching Frequency	PFC converter: Variable Resonant converter: Variable	85 kHz typical 100 kHz typical

3. OUTPUT SPECIFICATIONS

PARAMETER	DESCRIPTION / CONDITION	SPECIFICATION
Output Power	Convection	600 W
Efficiency	120 VAC: 240 VAC:	88% Typical 93%
Hold-up Time	120 VAC / 240 VAC:	8 ms
Line Regulation		+/-0.5%
Load Regulation		+/-1.0%
Transient Response	50% to 100% load change, 50 Hz, 50% duty cycle, 0.1 A/µs	< 10%, recovery time < 5 ms
Voltage Adjustment		+/-3%
Set Point Tolerance		+/-1%
Rise Time		<100 ms
Over Current Protection	Hic-Up Type, autorecovery	110%
Over Voltage Protection	Latch Type, AC Power to be recycled for recovery	114%
Short Circuit Protection	Latch Type, AC Power to be recycled for recovery	
Over Temperature Protection	Autorecovery	130 - 140°C primary heat sink
Current Share	Up to 3 supplies connected in parallel (optional)	

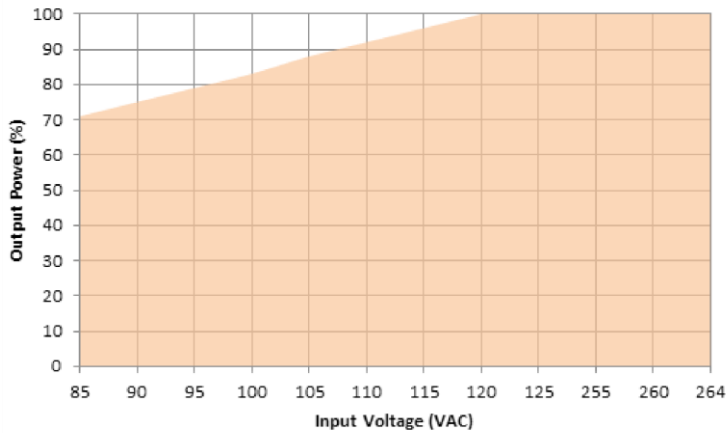
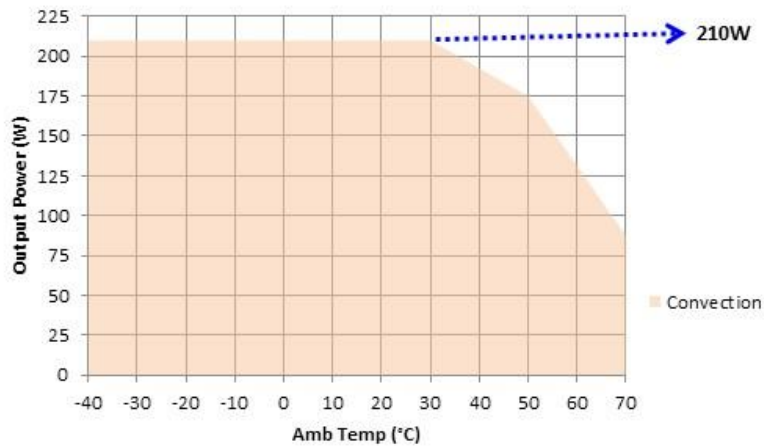
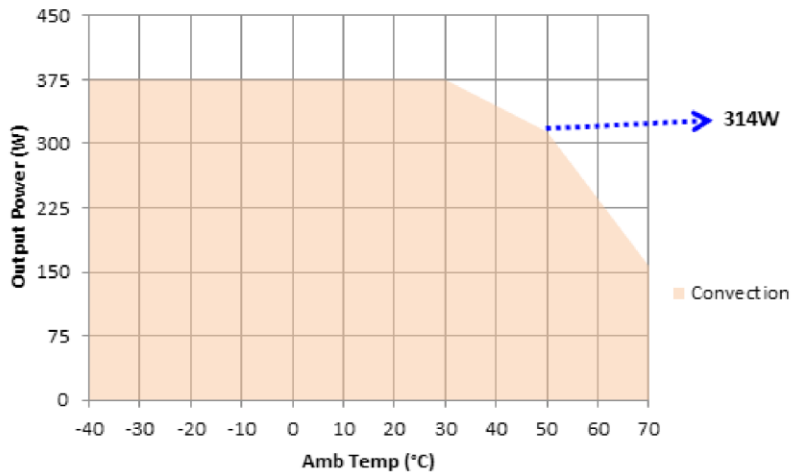

Figure 1. Power Derating w.r.t Input



Convection load: 300 W up to 30 °C
 De-rate between 30-50 °C @ 0.833% per °C
 De-rate above 50 °C @ 2.5% per °C

Figure 2. Power Derating Curve 12 V



Convection load: 375 W up to 30 °C
 De-rate between 30-50 °C @ 0.8133% per °C
 De-rate above 50 °C @ 2.5% per °C

Figure 3. Power Derating Curve 15 V

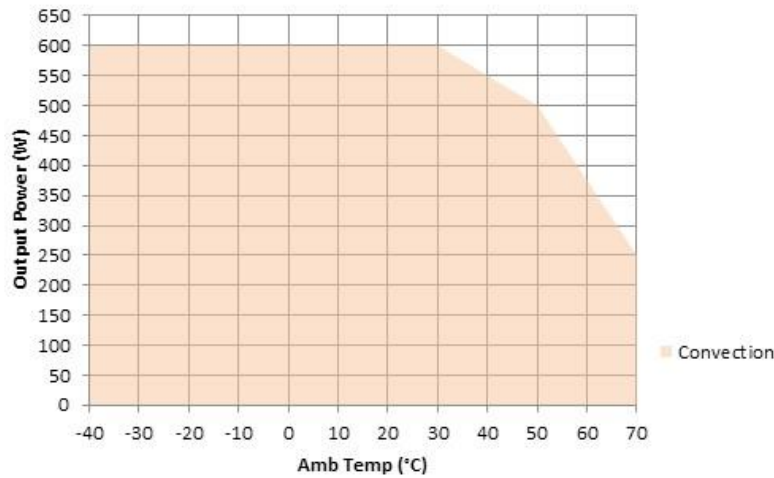

Convection load: 600 W up to 30 °C
 De-rate between 30-50 °C @ 0.833% per °C
 De-rate above 50 °C @ 2.5% per °C

Figure 4. Power Derating Curve 24 V and above

4. ENVIRONMENTAL SPECIFICATIONS

PARAMETER	DESCRIPTION / CONDITION	SPECIFICATION
Operating Temperature	Refer to derating curve	-40 to +70°C
Storage Temperature		-40 to +85°C
Relative Humidity	Non-condensing	5% to 95%
Altitude	Operating: Non-operating:	16,000 ft. 40,000 ft.
MTBF	Telcordia -SR332-issue 3	3.37 million hours

5. EMC SPECIFICATIONS

PARAMETER	DESCRIPTION / CONDITION	CRITERIA
Conducted Emissions	EN55032	Class B
Radiated Emissions	EN 55032	Class A (Class B with External king core K5B RC 25x12x15-M or equivalent)
Input Current Harmonics	EN 61000-3-2	Class A
Voltage Fluctuation and Flicker	EN 61000-3-3	Pass
ESD Immunity	EN 61000-4-2	A
Radiated Field Immunity	EN 61000-4-3	A
Electrical Fast Transient Immunity	EN 61000-4-4	A
Surge Immunity	EN 61000-4-5	A
Conducted Immunity	EN 61000-4-6	A
Magnetic Field Immunity	EN 61000-4-8	A
Voltage Dips, Interruptions	EN 61000-4-11	A & B

6. SAFETY SPECIFICATIONS

PARAMETER	DESCRIPTION / CONDITION	SPECIFICATION
Isolation Voltage	Input to Output Input to Earth	4000 VDC 2500 VDC
Safety Standard(s)	IEC/EN 62368-1, ED 2 UL62368-1, CSA C22.2 No. 62368-1	
Agency Approvals	Nemko, UL, C-UL	
CE mark	Complies with LVD Directive	

NOTES:

1. For Ripple measurement minimum output power requirement is 25 W. Ripple is peak to peak with 20 MHz bandwidth and 10 μ F (Tantalum capacitor) in parallel with a 0.1 μ F capacitor at rated line voltage and load ranges. Please contact factory/ sales representative for minimum load required for ripple to be within specification.
2. Combined output power of main output, fan supply and standby supply shall not exceed max. power rating.
3. Standby output voltage 5 V / 1.5 A (convection) with tolerance including set point accuracy, line and load regulation is +/-10%. Ripple and noise is less than 5%.
4. Specifications are for nominal input voltage, 25°C unless otherwise stated.
5. PSU is supplied with J3, pin-6 and pin-7 shorted to enable main output without remote on/off feature.

7. SIGNALS

PARAMETER	DESCRIPTION / CONDITION
Power Good / Fail Signal	Power Good: Is a TTL signal which goes high after main output reaches 90% of its set value. The delay is 0.1 s to 0.5 s Power Fail: The same signal goes low at least 1ms before main output falls to 90% of set value at AC Power off
Remote Sense	Compensates for 200 mV drop
Remote On / Off	Pin 6 & Pin 7 of J3 can be used for Remote on/off. Shorting Pin 6 to Pin 7 enables main output while keeping the pins open disables main output
OCP Limit Set	Pin 8 & Pin 9 of J3 must be left open

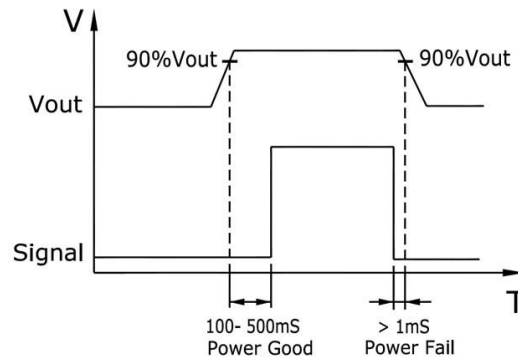

Figure 5. Power Good / Fail Signal Diagram

8. CONNECTOR & PIN DESCRIPTION

CONNECTOR	PIN	DESCRIPTION / CONDITION	MANUFACTURER / PN
AC Input Connector	J1	Pin 1 AC Line Pin 2 Neutral Pin 3 Earth	TE Connectivity: NC6-P107-03
DC Output Connector	J2	J2-A +VE J2-B -VE	6-32 inches Screw Pan HD Mating: Designed to accept Ring Tongue Terminal AMP: 8-31886-1, wherein one 16 AWG (max) wire can be crimped. Note: One Ring Tongue Terminal with 16 AWG is recommended for current up to 11 A only. Use multiple tongue terminals with wire for more current.
Aux (Fan) Output	J3 ¹	Pin 1 GND Pin 2 5V AUX Pin 3 PGPF Pin 4 VS - Pin 5 VS + Pin 6 GND Pin 7 RMT Pin 8 CL2 Pin 9 CL1 Pin 10 LS	Molex: 22-23-2101 Mating: 22-01-2107; Pins: 08-50-0113
Fan Output	J10, J11	Pin 1 +VE Pin 2 -VE	

9. MECHANICAL SPECIFICATIONS

PARAMETER	DESCRIPTION / CONDITION
Weight	1100 g
Dimensions	127 x 216 x 41 mm (5.0 x 8.5 x 1.61 inches)
Cooling	Convection: 600 W (U-Channel)

¹ PSU is supplied with J3, pin-6 and pin-7 shorted to enable main output without remote on/off feature.

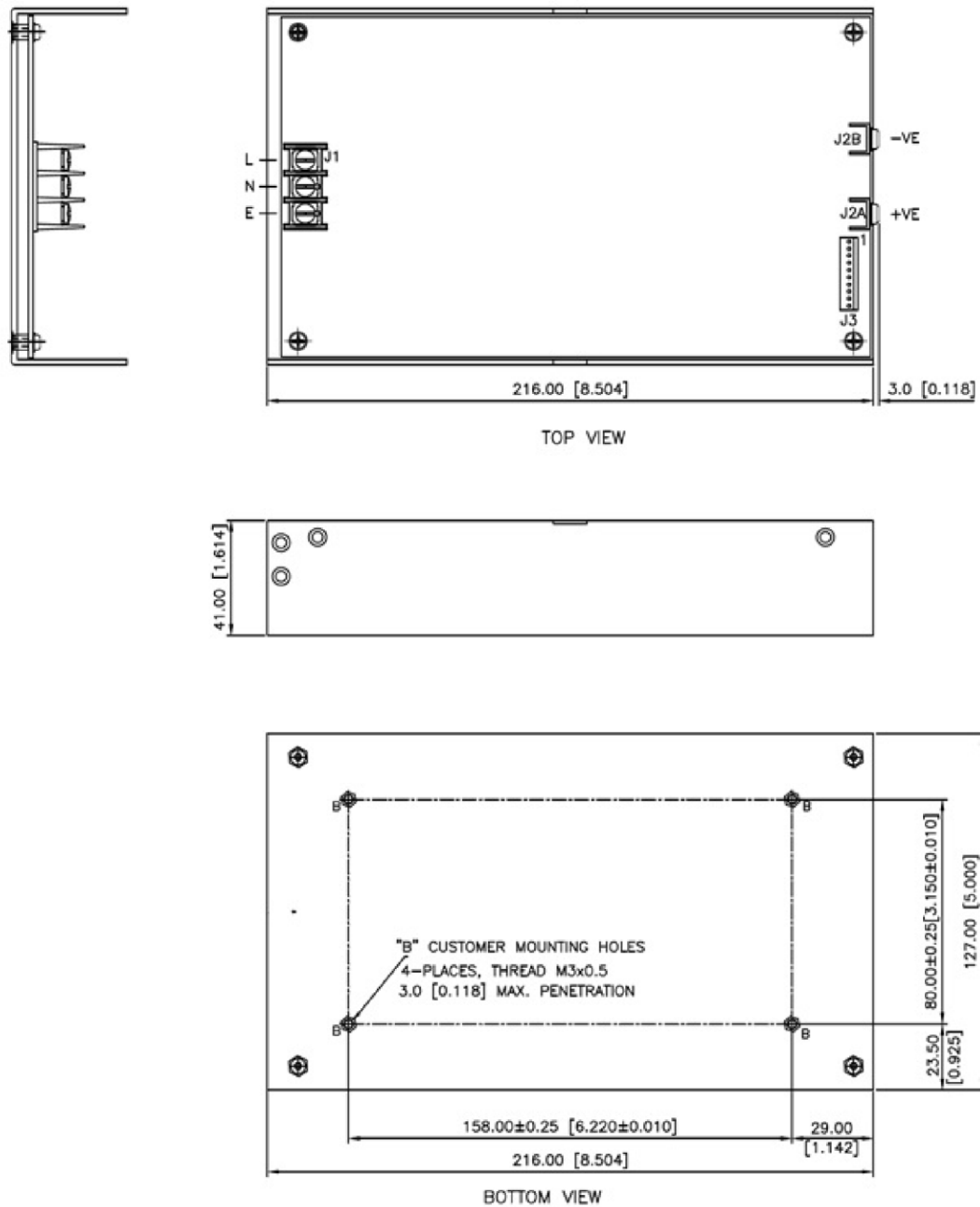

MECHANICAL OUTLINE DIMENSIONS
 ALL DIMENSIONS ARE IN MM [INCHES]
 GEN.TOLERANCE: ±1.0 MM [±0.04]

Figure 6. Mechanical drawings

10. INSTALLTION INSTRUCTION FOR CURRENT SHARING

During the installation and setup of parallel supplies in a system it is important that a single remote sense point be used for all the supplies. The remote sense voltage between the supplies must be adjusted to within 1% to ensure the supplies are inside the 1% capture window. If the supplies are not initially adjusted inside the capture window the supplies will not current share satisfactorily.

SET-UP PROCEDURE:

1. Connect load cables to the outputs of each supply.
2. Connect the remote sense lines to the load in twisted style. (A common remote sense point must be used for all the supplies in parallel).
3. Connect all the "LS" signal (Pin 10) on the J3 connector between the supplies.
4. Adjust remote sense voltage of each supply to within 1% of rated output voltage or readjust to required set point. (Adjustment to be done with all other parallel supplies off).
5. Current sharing between the supplies can be verified by monitoring the output current of each supply with a hall effect DC current probe. The supplies should share to within 10% of the total load current.
6. The current share circuit has a capture window voltage of +/- 1% of the rated output voltage. If the output remote sense voltage of one of the supplies is adjusted outside the 1% window the supplies will not current share satisfactorily.

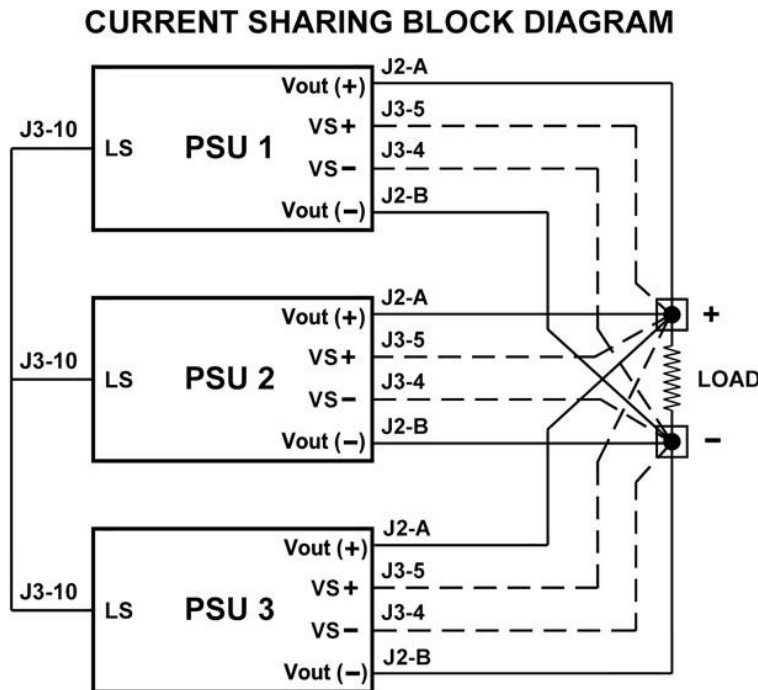

Figure 7. Current Sharing Block Diagram

For more information on these products consult: tech.support@psbel.com

NUCLEAR AND MEDICAL APPLICATIONS - Products are not designed or intended for use as critical components in life support systems, equipment used in hazardous environments, or nuclear control systems.

TECHNICAL REVISIONS - The appearance of products, including safety agency certifications pictured on labels, may change depending on the date manufactured. Specifications are subject to change without notice.