

MAX30205 Human Body Temperature Sensor Evaluation Kit

Evaluates: MAX30205

General Description

The MAX30205 evaluation kit (EV kit) provides a convenient way to evaluate the MAX30205 human body temperature sensor. The sensor uses a high-resolution, sigma-delta, analog-to-digital converter to accurately measure temperature and convert it to digital form. The kit includes a USB-to-I²C controller and GUI program to simplify evaluation.

Features

- Quick Evaluation of the MAX30205
- USB Powered
- Full Assembled and Tested
- Windows® 7, 8, and 10-Compatible Software

Quick Start

Required Equipment

- MAX30205 EV kit temperature sensor PCB
- MAX30205 EV kit USBDTMB PCB
- MAX30205 EV kit 10-pin flex cable
- Micro-USB cable
- MAX30205 EV kit GUI program
- Windows PC

[Ordering Information](#) appears at end of data sheet.

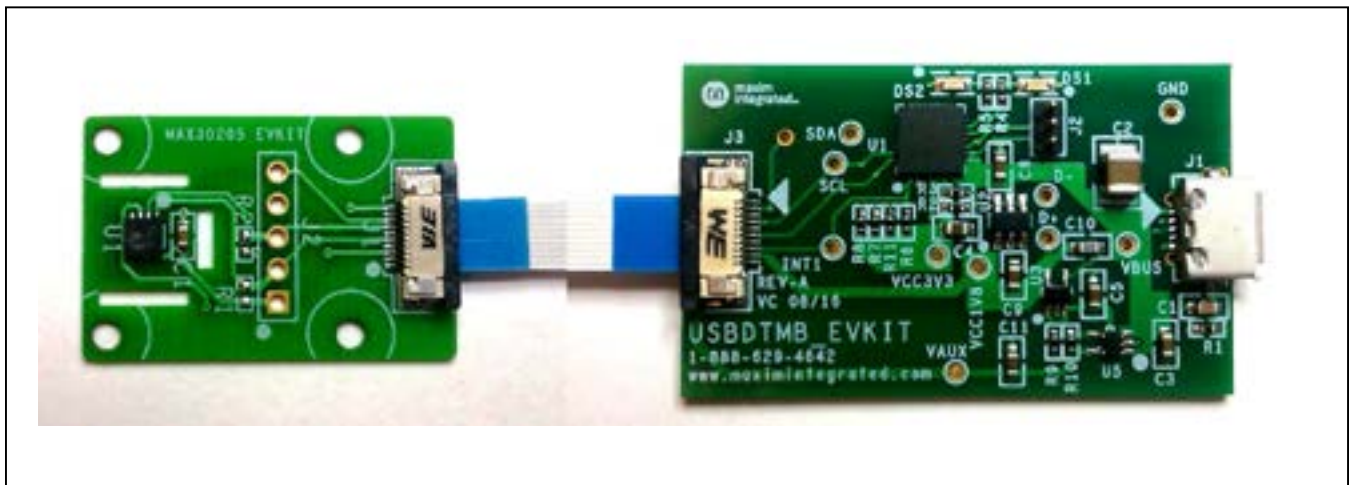

Figure 1. MAX30205 EV Kit Temperature Sensor and USBDTMB Controller PCB

Windows is a registered trademark and service mark of Microsoft Corp.

MAX30205 Human Body Temperature Sensor Evaluation Kit

Evaluates: MAX30205

Procedure

The MAX30205 EV kit is fully assembled and tested. Follow the steps below to verify board operation:

- 1) Visit www.maximintegrated.com/evkit-software to download the most recent version of the EV kit software, *MAX30205EVKitSetupVx.x.ZIP*. Save the EV kit software to a temporary folder and uncompress the ZIP file.
- 2) Open up *MAX30205EVKitSetupVx.x.exe* and follow the instructions from the pop-up windows.
- 3) Insert one end of the ribbon cable to the J3 connector of the USBDTMB and the other end of the ribbon cable to the J1 connector of the MAX30205 EV kit. Make sure that both connectors and blue ends of the ribbon cable is facing the user.
- 4) Connect the USB cable from the PC to the EV kit board. Windows automatically installs all drivers.
- 5) Open the *MAX30205EVKit.exe* and verify that the EV kit is connected by observing the status bar at the lower left corner of the GUI. See [Figure 2](#).
- 6) The GUI program updates the temperature every 20s.

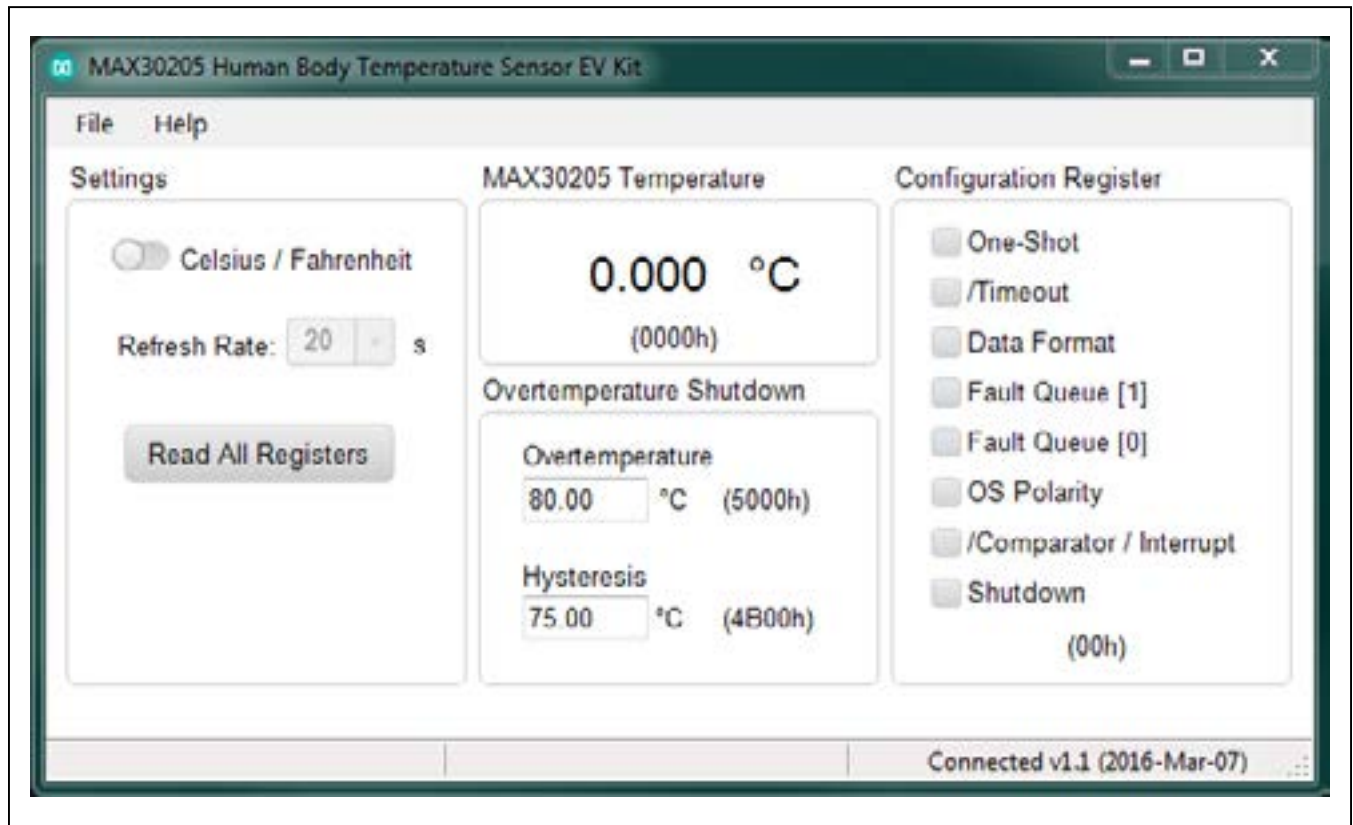

Figure 2. MAX30205 EV Kit GUI Main Window

MAX30205 Human Body Temperature Sensor Evaluation Kit

Evaluates: MAX30205

Detailed Description

The MAX30205 EV kit provides a convenient way to evaluate the MAX30205 human body temperature sensor.

The sensor PCB contains a MAX30205 human body temperature sensor to allow for temperature data to be sampled and transferred to the GUI. The MAX30205 EV kit USBTMB PCB is used to do I²C to HID transaction translation, transporting the raw temperature data to the PC through the USB.

Units

Temperature units can be displayed in either Celsius or Fahrenheit.

Refresh Rate

Use the GUI to set the temperature sample refresh rate. A minimum of 10sps should be used to avoid self-heating of the sensor.

Configuration Register

The MAX30205 temperature sensor configuration register can be set by selecting the check boxes in the GUI.

Refer to the MAX30205 IC data sheet for detailed information regarding the operation of the IC.

Ordering Information

PART	TYPE
MAX30205EVSYS#	EV Kit

#Denotes RoHS compliant.

Table 1. Slave Address Configuration

LOGIC INPUTS			I ² C SLAVE ADDRESS									
A2	A1	A0	B7	B6	B5	B4	B3	B2	B1	R/W	READ ADD	WRITE ADD
0	0	0	1	0	0	1	0	0	0	1/0	0x91	0x90

Table 2. Temperature Register Definition

UPPER BYTE								LOWER BYTE							
D15	D14	D13	D12	D11	D10	D9	D8	D7	D6	D5	D4	D3	D2	D1	D0
S	64	32	16	8	4	2	1	1/2	1/4	1/8	1/16	1/32	1/64	1/128	1/256
	26	25	24	23	22	21	20	2-1	2-2	2-3	2-4	2-5	2-6	2-7	2-8

(S sign bit, Units in °C)

Table 3. Connector J1

PIN	SIGNAL	DESCRIPTION
1	GND	Ground
2	N.C.	—
3	N.C.	—
4	GND	Ground
5	SDA	I ² C Data
6	GND	Ground
7	SCL	I ² C Clock
8	GND	Ground
9	N.C.	—
10	V _{DD}	3.0V Power

MAX30205 Human Body Temperature Sensor Evaluation Kit

Evaluates: MAX30205

MAX30205 EV Bill of Materials

ITEM	REF_DES	DNI/DNP	QTY	MFG PART #	MANUFACTURER	VALUE	DESCRIPTION
1	C1	—	1	GRM188R72A104KA35; CC0603KRX7R0BB104	MURATA; TDK	0.1UF	CAPACITOR; SMT (0603); CERAMIC CHIP; 0.1UF; 100V; TOL=10%; TG=-55 DEGC TO +125 DEGC; TC=X7R
2	J1	—	1	68711014522	WURTH ELECTRONICS INC.	68711014522	CONNECTOR; FEMALE; SMT; 0.5MM ZIF HORIZONTAL BOTTOM CONTACT WR-FPC; RIGHT ANGLE; 10PINS
3	U1	—	1	MAX30205MTA+	MAXIM	MAX30205MTA+	IC; SNSR; HUMAN BODY TEMPERATURE SENSOR; TDFN8-EP
4	J2	DNP	0	TSW-105-07-L-S	SAMTEC	TSW-105-07-L-S	CONNECTOR; THROUGH HOLE; TSW SERIES; SINGLE ROW; STRAIGHT; 5PINS
5	R1, R2	DNP	0	CR0402-16W-4871FT; CRCW04024K87FK	VENKEL LTD./ VISHAY DALE	4.87K	RESISTOR; 0402; 4.87K OHM; 1%; 100PPM; 0.063W; THICK FILM
6	PCB	—	1	MAX30205	MAXIM	PCB	PCB Board:MAX30205 EVALUATION KIT
TOTAL			4				

NOTE: DNI--> DO NOT INSTALL ; DNP--> DO NOT PROCURE

MAX30205 EV Schematic

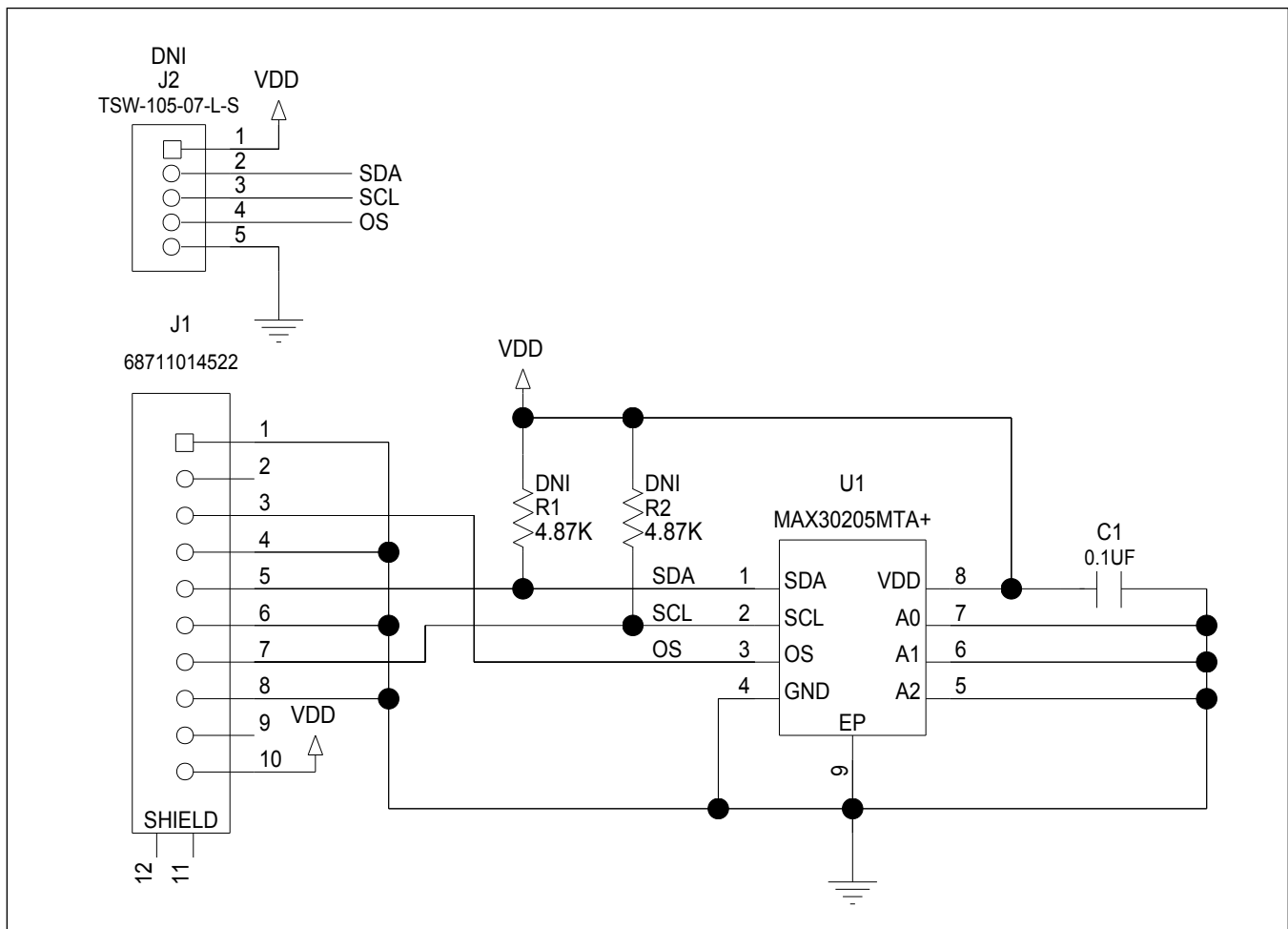

MAX30205 EV PCB Layout Diagrams

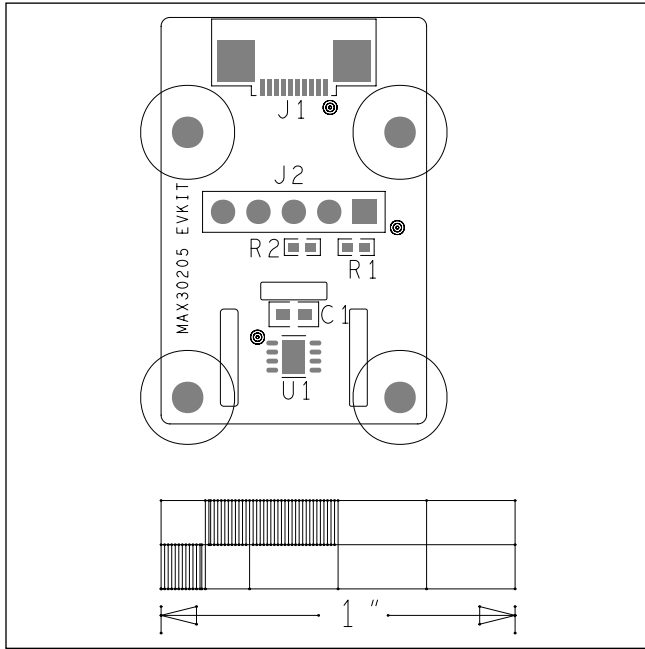

MAX30205 EV—Top Silkscreen

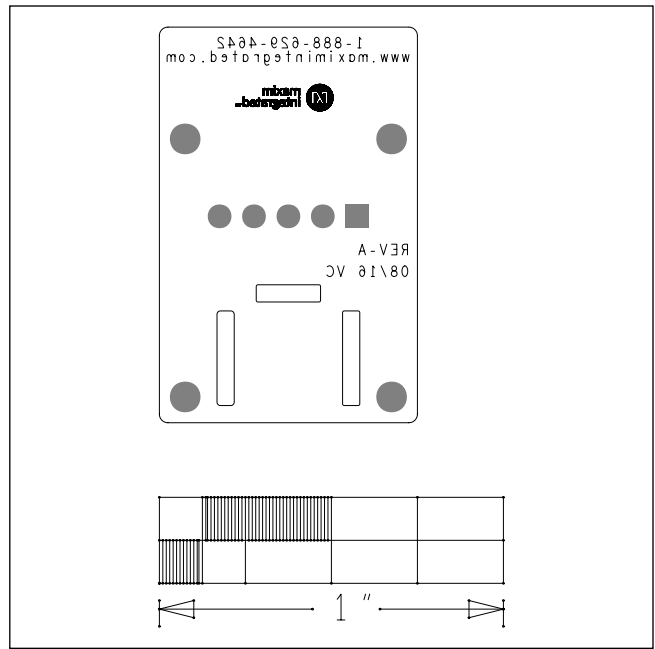

MAX30205 EV—Bottom Silkscreen

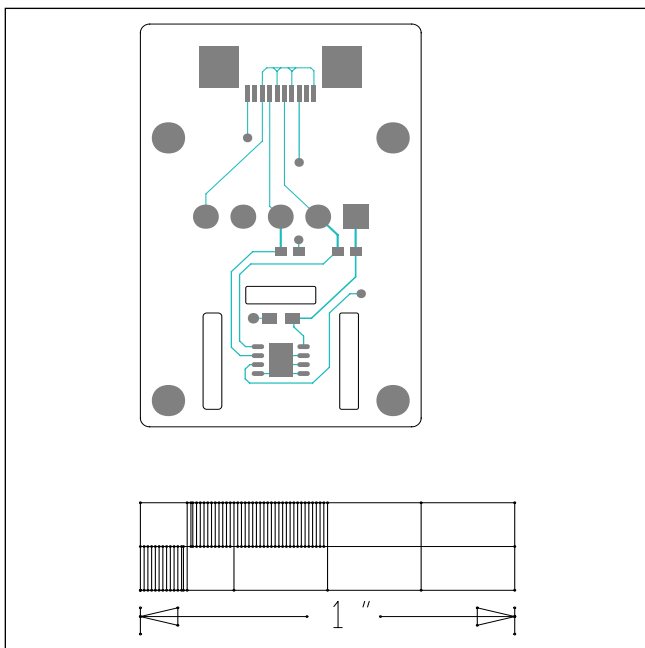

MAX30205 EV—Top

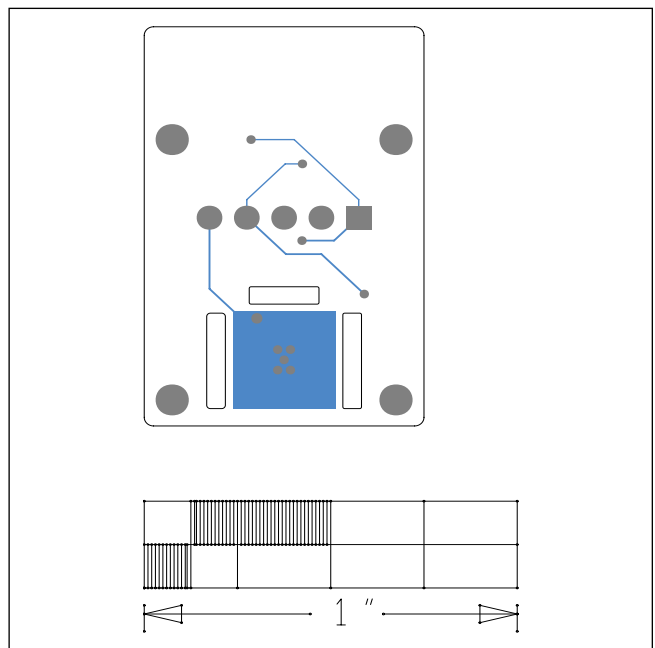

MAX30205 EV—Bottom

Revision History

REVISION NUMBER	REVISION DATE	DESCRIPTION	PAGES CHANGED
0	9/16	Initial release	—

For pricing, delivery, and ordering information, please contact Maxim Direct at 1-888-629-4642, or visit Maxim Integrated's website at www.maximintegrated.com.

Maxim Integrated cannot assume responsibility for use of any circuitry other than circuitry entirely embodied in a Maxim Integrated product. No circuit patent licenses are implied. Maxim Integrated reserves the right to change the circuitry and specifications without notice at any time.