

# E6B2-C

## General-purpose Encoder with Diameter of 40 mm

- A wide operating voltage range of 5 to 24 VDC (Open-collector Models).
- Resolution of 2,000 pules/rotation in 40-mm housing.
- Phase Z can be adjusted with ease using the origin indicating function.
- Shaft loading of 30 N radial and 20 N thrust.
- Improved reliability with reverse connection and load short-circuit protection (except for line-driver outputs).



 Be sure to read *Safety Precautions* on page 4.

## Ordering Information

**Encoders** [Refer to *Dimensions* on page 4.]

Power supply voltage	Output configuration	Resolution (pulses/rotation)	Model
5 to 24 VDC	NPN open-collector output	10, 20, 30, 40, 50, 60, 100, 200, 300, 360, 400, 500, 600	<b>E6B2-CWZ6C (resolution) 0.5M</b> Example: E6B2-CWZ6C 10P/R 0.5M
		720, 800, 1,000, 1,024	
		1,200, 1,500, 1,800, 2,000	
12 to 24 VDC	PNP open-collector output	100, 200, 360, 500, 600	<b>E6B2-CWZ5B (resolution) 0.5M</b> Example: E6B2-CWZ5B 100P/R 0.5M
		1,000	
		2,000	
5 to 12 VDC	Voltage output	10, 20, 30, 40, 50, 60, 100, 200, 300, 360, 400, 500, 600	<b>E6B2-CWZ3E (resolution) 0.5M</b> Example: E6B2-CWZ3E 10P/R 0.5M
		1,000	
		1,200, 1,500, 1,800, 2,000	
5 VDC	Line-driver output	10, 20, 30, 40, 50, 60, 100, 200, 300, 360, 400, 500, 600	<b>E6B2-CWZ1X (resolution) 0.5M</b> Example: E6B2-CWZ1X 10P/R 0.5M
		1,000, 1,024	
		1,200, 1,500, 1,800, 2,000	

**Accessories (Order Separately)** [Refer to *Dimensions* on *Rotary Encoder Accessories*.]

Name	Model	Remarks
Couplings	<b>E69-C06B</b>	Provided with the product.
	<b>E69-C68B</b>	Different end diameter
	<b>E69-C610B</b>	Different end diameter
	<b>E69-C06M</b>	Metal construction
Flanges	<b>E69-FBA</b>	---
	<b>E69-FBA02</b>	E69-2 Servo Mounting Bracket provided.
Servo Mounting Bracket	<b>E69-2</b>	---

Refer to *Accessories* for details.

## Ratings and Specifications

Item	Model	E6B2-CWZ6C	E6B2-CWZ5B	E6B2-CWZ3E	E6B2-CWZ1X
Power supply voltage		5 VDC -5% to 24 VDC +15%, ripple (p-p): 5% max.	12 VDC -10% to 24 VDC +15%, ripple (p-p): 5% max.	5 VDC -5% to 12 VDC +10%, ripple (p-p): 5% max.	5 VDC ±5%, ripple (p-p): 5% max.
Current consumption *1		80 mA max.	100 mA max.		160 mA max.
Resolution (pulses/rotation)		10, 20, 30, 40, 50, 60, 100, 200, 300, 360, 400, 500, 600, 720, 800, 1,000, 1,024, 1,200, 1,500, 1,800, 2,000	100, 200, 360, 500, 600, 1,000, 2,000	10, 20, 30, 40, 50, 60, 100, 200, 300, 360, 400, 500, 600, 1,000, 1,200, 1,500, 1,800, 2,000	10, 20, 30, 40, 50, 60, 100, 200, 300, 360, 400, 500, 600, 1,000, 1,024, 1,200, 1,500, 1,800, 2,000
Output phases		Phases A, B, and Z			Phases A, $\bar{A}$ , B, $\bar{B}$ , Z, and $\bar{Z}$
Phase difference between outputs		90°±45° between A and B (1/4 T ± 1/8 T)			
Output configuration		NPN open-collector output	PNP open-collector output	Voltage output (NPN output)	Line driver output *2
Output capacity		Applied voltage: 30 VDC max. Sink current: 35 mA max. Residual voltage: 0.4 V max. (at sink current of 35 mA)	Applied voltage: 30 VDC max. Source current: 35 mA max. Residual voltage: 0.4 V max. (at source current of 35 mA)	Output resistance: 2 kΩ Sink current: 20 mA max. Residual voltage: 0.4 V max. (at sink current of 20 mA)	AM26LS31 equivalent Output current High level: $I_o = -20$ mA Low level: $I_s = 20$ mA Output voltage: $V_o = 2.5$ V min. $V_s = 0.5$ V max.
Maximum response frequency *3		100 kHz	50 kHz	100 kHz	
Rise and fall times of output		1 μs max. (Control output voltage: 5 V, Load resistance: 1 kΩ, Cable length: 2 m max.)	1 μs max. (Cable length: 2 m max., Sink current: 10 mA)		0.1 μs max. (Cable length: 2 m max., $I_o = -20$ mA, $I_s = 20$ mA)
Starting torque		0.98 mN·m max.			
Moment of inertia		1×10 <sup>-6</sup> kg·m <sup>2</sup> max.; 3 × 10 <sup>-7</sup> kg·m <sup>2</sup> max. at 600 P/R max.			
Shaft loading	Radial	30 N			
	Thrust	20 N			
Maximum permissible speed		6,000 r/min			
Protection circuits		Power supply reverse polarity protection, Load short-circuit protection			---
Ambient temperature range		Operating: -10 to 70°C (with no icing), Storage: -25 to 85°C (with no icing)			
Ambient humidity range		Operating/Storage: 35% to 85% (with no condensation)			
Insulation resistance		20 MΩ min. (at 500 VDC) between current-carrying parts and case			
Dielectric strength		500 VAC, 50/60 Hz for 1 min between current-carrying parts and case			
Vibration resistance		Destruction: 10 to 500 Hz, 150 m/s <sup>2</sup> or 2-mm double amplitude for 11 min 3 times each in X, Y, and Z directions			
Shock resistance		Destruction: 1,000m/s <sup>2</sup> 3 times each in X, Y, and Z directions			
Degree of protection		IEC 60529 IP50			
Connection method		Pre-wired Models (Standard cable length: 500 mm)			
Materials		Case: ABS, Main unit: Aluminum, Shaft: SUS420J2			
Weight (packed state)		Approx. 100 g			
Accessories		Coupling, Hexagonal wrench, Instruction manual			

\*1. An inrush current of approximately 9 A will flow for approximately 0.3 ms when the power is turned ON.

\*2. The line driver output is a data transmission circuit compatible with RS-422A and long-distance transmission is possible with a twisted-pair cable. The quality is equivalent to AM26LS31.

\*3. The maximum electrical response speed is determined by the resolution and maximum response frequency as follows:

$$\text{Maximum electrical response speed (rpm)} = \frac{\text{Maximum response frequency}}{\text{Resolution}} \times 60$$

This means that the E6B2-C Rotary Encoder will not operate electrically if its speed exceeds the maximum electrical response speed.

## I/O Circuit Diagrams

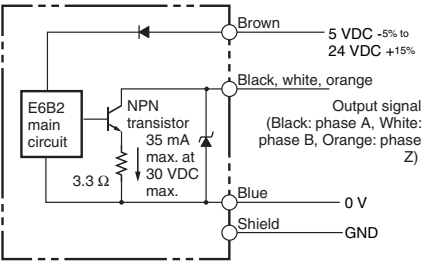
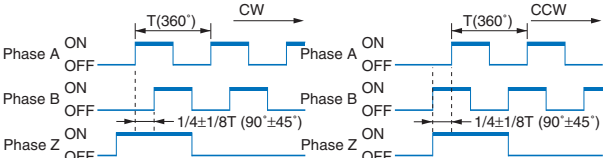
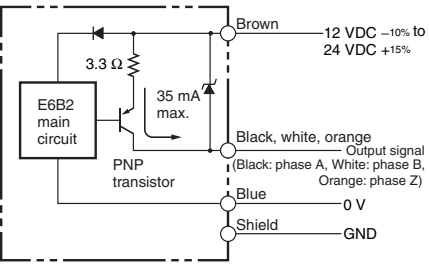
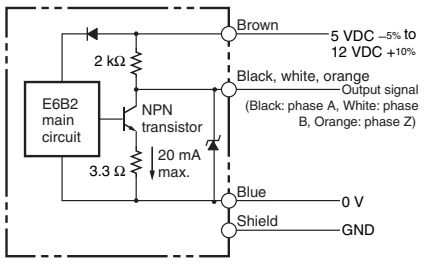
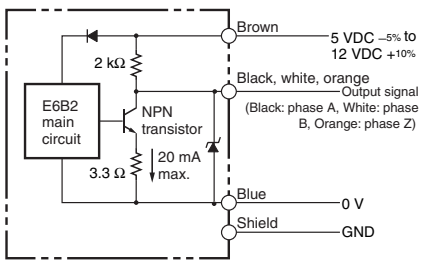
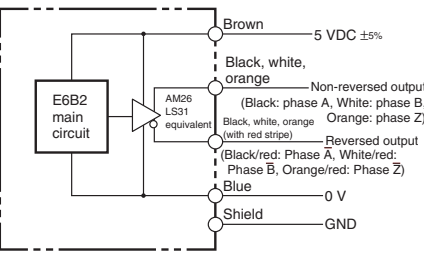
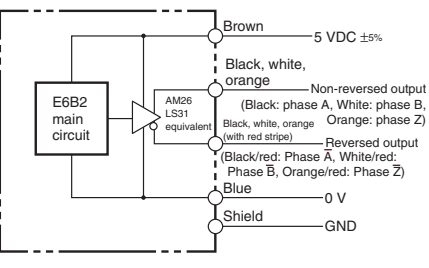
Model/Output Circuits	Output mode	Connection																		
<p><b>E6B2-CWZ6C</b></p>  <p>5 VDC <math>-5\%</math> to <math>24</math> VDC <math>+15\%</math></p> <p>Black, white, orange Output signal (Black: phase A, White: phase B, Orange: phase Z)</p> <p>Blue 0 V</p> <p>Shield GND</p>	<p><b>E6B2-CWZ6C NPN Open-collector Output Model</b> <b>E6B2-CWZ5B PNP Open-collector Output Model</b></p> <p>Direction of rotation: CW (as viewed from end of shaft)      Direction of rotation: CCW (as viewed from end of shaft)</p>  <p>Phase A ON OFF      Phase A ON OFF Phase B OFF ON      Phase B OFF ON Phase Z ON OFF      Phase Z ON OFF</p> <p>Note: Phase A is <math>1/4 T \pm 1/8 T</math> faster than phase B. The ONs in the above timing chart mean that the output transistor is ON and the OFFs mean that the output transistor is OFF.</p> <p>Note: Phase A is <math>1/4 T \pm 1/8 T</math> slower than phase B.</p>																			
<p><b>E6B2-CWZ5B</b></p>  <p>12 VDC <math>-10\%</math> to <math>24</math> VDC <math>+15\%</math></p> <p>Black, white, orange Output signal (Black: phase A, White: phase B, Orange: phase Z)</p> <p>Blue 0 V</p> <p>Shield GND</p>		<table border="1"> <thead> <tr> <th>Color</th> <th>Terminal</th> </tr> </thead> <tbody> <tr> <td>Brown</td> <td>Power supply (+Vcc)</td> </tr> <tr> <td>Black</td> <td>Output phase A</td> </tr> <tr> <td>White</td> <td>Output phase B</td> </tr> <tr> <td>Orange</td> <td>Output phase Z</td> </tr> <tr> <td>Blue</td> <td>0 V (common)</td> </tr> </tbody> </table>	Color	Terminal	Brown	Power supply (+Vcc)	Black	Output phase A	White	Output phase B	Orange	Output phase Z	Blue	0 V (common)						
Color	Terminal																			
Brown	Power supply (+Vcc)																			
Black	Output phase A																			
White	Output phase B																			
Orange	Output phase Z																			
Blue	0 V (common)																			
<p><b>E6B2-CWZ3E</b></p>  <p>5 VDC <math>-5\%</math> to <math>12</math> VDC <math>+10\%</math></p> <p>Black, white, orange Output signal (Black: phase A, White: phase B, Orange: phase Z)</p> <p>Blue 0 V</p> <p>Shield GND</p>	<p><b>E6B2-CWZ3E Voltage Output Model</b></p> <p>Direction of rotation: CW (as viewed from end of shaft)      Direction of rotation: CCW (as viewed from end of shaft)</p>  <p>Phase A H L      Phase A H L Phase B L H      Phase B L H Phase Z H L      Phase Z H L</p> <p>Note: Phase A is <math>1/4 T \pm 1/8 T</math> faster than phase B.</p> <p>Note: Phase A is <math>1/4 T \pm 1/8 T</math> slower than phase B.</p>																			
<p><b>E6B2-CWZ1X</b></p>  <p>5 VDC <math>\pm 5\%</math></p> <p>Black, white, orange Non-reversed output (Black: phase A, White: phase B, Orange: phase Z)</p> <p>Black, white, orange (with red stripe) Reversed output (Black/red: Phase A, White/red: Phase B, Orange/red: Phase Z)</p> <p>Blue 0 V</p> <p>Shield GND</p>	<p><b>E6B2-CWZ1X Line Driver Output Model</b></p> <p>Direction of rotation: CW (as viewed from end of shaft)      Direction of rotation: CCW (as viewed from end of shaft)</p>  <p>Phase A H L      Phase A H L Phase B L H      Phase B L H Phase Z H L      Phase Z H L</p>	<table border="1"> <thead> <tr> <th>Color</th> <th>Terminal</th> </tr> </thead> <tbody> <tr> <td>Brown</td> <td>Power supply (+Vcc)</td> </tr> <tr> <td>Black</td> <td>Output phase A</td> </tr> <tr> <td>Black/red stripes</td> <td>Output phase A</td> </tr> <tr> <td>White</td> <td>Output phase B</td> </tr> <tr> <td>White/red stripes</td> <td>Output phase B</td> </tr> <tr> <td>Orange</td> <td>Output phase Z</td> </tr> <tr> <td>Orange/red stripes</td> <td>Output phase Z</td> </tr> <tr> <td>Blue</td> <td>0 V (common)</td> </tr> </tbody> </table> <p>Note: Receiver: AM26LS32 equivalent</p>	Color	Terminal	Brown	Power supply (+Vcc)	Black	Output phase A	Black/red stripes	Output phase A	White	Output phase B	White/red stripes	Output phase B	Orange	Output phase Z	Orange/red stripes	Output phase Z	Blue	0 V (common)
Color	Terminal																			
Brown	Power supply (+Vcc)																			
Black	Output phase A																			
Black/red stripes	Output phase A																			
White	Output phase B																			
White/red stripes	Output phase B																			
Orange	Output phase Z																			
Orange/red stripes	Output phase Z																			
Blue	0 V (common)																			

- Note: 1. The shielded cable outer core (shield) is not connected to the inner area or to the case.  
2. The phase A, phase B, and phase Z circuits are all identical.  
3. Normally, connect GND to 0 V or to an external ground.

## Safety Precautions

Refer to *Warranty and Limitations of Liability*.

**⚠ WARNING**

This product is not designed or rated for ensuring safety of persons either directly or indirectly. Do not use it for such purposes.



**Precautions for Safe Use**

Incorrect wiring may damage internal circuits.

**Precautions for Correct Use**

Do not use the Encoder under ambient conditions that exceed the ratings.

● **Mounting**

● **Origin Indication**

It is easy to adjust the position of phase Z with the origin indication function. The following illustration shows the relationship between phase Z and the origin. Set cut face D to the phase Z origin as shown in the illustration.

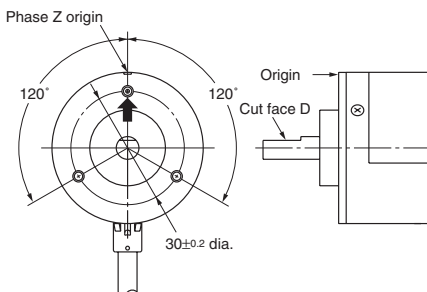

- Do not extend the length of the cable to more than 2 m. If the cable must be more than 2 m, use a Model with a Line-driver Output (max. length: 100 m).

● **Wiring**

Spurious pulses may be generated when power is turned ON and OFF. Wait at least 0.1 s after turning ON the power to the Encoder before using the connected device, and stop using the connected device at least 0.1 s before turning OFF the power to the Encoder. Also, turn ON the power to the load only after turning ON the power to the Encoder.

(Unit: mm)

## Dimensions

Tolerance class IT16 applies to dimensions in this datasheet unless otherwise specified.

## Encoder

**E6B2-C**

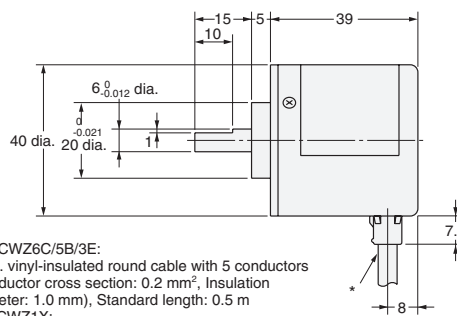
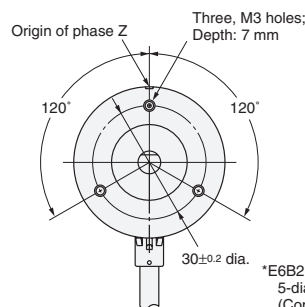
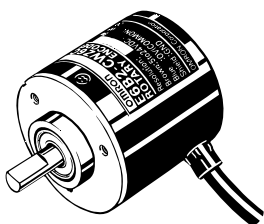

\*E6B2-CWZ6C/5B/3E:  
5-dia. vinyl-insulated round cable with 5 conductors  
(Conductor cross section: 0.2 mm<sup>2</sup>, Insulation diameter: 1.0 mm), Standard length: 0.5 m  
E6B2-CWZ1X:  
5-dia. vinyl-insulated round cable with 8 conductors  
(Conductor cross section: 0.2 mm<sup>2</sup>, Insulation diameter: 1.0 mm), Standard length: 0.5 m

## Accessories (Order Separately)

**Couplings**

- E69-C06B
- E69-C68B
- E69-C610B
- E69-C06M

**Flanges**

- E69-FBA
- E69-FBA02

**Servo Mounting Bracket**

- E69-2

Refer to *Accessories* for details.

## Read and Understand This Catalog

Please read and understand this catalog before purchasing the products. Please consult your OMRON representative if you have any questions or comments.

## Warranty and Limitations of Liability

### WARRANTY

OMRON's exclusive warranty is that the products are free from defects in materials and workmanship for a period of one year (or other period if specified) from date of sale by OMRON.

OMRON MAKES NO WARRANTY OR REPRESENTATION, EXPRESS OR IMPLIED, REGARDING NON-INFRINGEMENT, MERCHANTABILITY, OR FITNESS FOR PARTICULAR PURPOSE OF THE PRODUCTS. ANY BUYER OR USER ACKNOWLEDGES THAT THE BUYER OR USER ALONE HAS DETERMINED THAT THE PRODUCTS WILL SUITABLY MEET THE REQUIREMENTS OF THEIR INTENDED USE. OMRON DISCLAIMS ALL OTHER WARRANTIES, EXPRESS OR IMPLIED.

### LIMITATIONS OF LIABILITY

OMRON SHALL NOT BE RESPONSIBLE FOR SPECIAL, INDIRECT, OR CONSEQUENTIAL DAMAGES, LOSS OF PROFITS OR COMMERCIAL LOSS IN ANY WAY CONNECTED WITH THE PRODUCTS, WHETHER SUCH CLAIM IS BASED ON CONTRACT, WARRANTY, NEGLIGENCE, OR STRICT LIABILITY.

In no event shall the responsibility of OMRON for any act exceed the individual price of the product on which liability is asserted.

IN NO EVENT SHALL OMRON BE RESPONSIBLE FOR WARRANTY, REPAIR, OR OTHER CLAIMS REGARDING THE PRODUCTS UNLESS OMRON'S ANALYSIS CONFIRMS THAT THE PRODUCTS WERE PROPERLY HANDLED, STORED, INSTALLED, AND MAINTAINED AND NOT SUBJECT TO CONTAMINATION, ABUSE, MISUSE, OR INAPPROPRIATE MODIFICATION OR REPAIR.

## Application Considerations

### SUITABILITY FOR USE

OMRON shall not be responsible for conformity with any standards, codes, or regulations that apply to the combination of products in the customer's application or use of the products.

At the customer's request, OMRON will provide applicable third party certification documents identifying ratings and limitations of use that apply to the products. This information by itself is not sufficient for a complete determination of the suitability of the products in combination with the end product, machine, system, or other application or use.

The following are some examples of applications for which particular attention must be given. This is not intended to be an exhaustive list of all possible uses of the products, nor is it intended to imply that the uses listed may be suitable for the products:

- Outdoor use, uses involving potential chemical contamination or electrical interference, or conditions or uses not described in this catalog.
- Nuclear energy control systems, combustion systems, railroad systems, aviation systems, medical equipment, amusement machines, vehicles, safety equipment, and installations subject to separate industry or government regulations.
- Systems, machines, and equipment that could present a risk to life or property.

Please know and observe all prohibitions of use applicable to the products.

NEVER USE THE PRODUCTS FOR AN APPLICATION INVOLVING SERIOUS RISK TO LIFE OR PROPERTY WITHOUT ENSURING THAT THE SYSTEM AS A WHOLE HAS BEEN DESIGNED TO ADDRESS THE RISKS, AND THAT THE OMRON PRODUCTS ARE PROPERLY RATED AND INSTALLED FOR THE INTENDED USE WITHIN THE OVERALL EQUIPMENT OR SYSTEM.

### PROGRAMMABLE PRODUCTS

OMRON shall not be responsible for the user's programming of a programmable product, or any consequence thereof.

## Disclaimers

### CHANGE IN SPECIFICATIONS

Product specifications and accessories may be changed at any time based on improvements and other reasons.

It is our practice to change model numbers when published ratings or features are changed, or when significant construction changes are made. However, some specifications of the products may be changed without any notice. When in doubt, special model numbers may be assigned to fix or establish key specifications for your application on your request. Please consult with your OMRON representative at any time to confirm actual specifications of purchased products.

### DIMENSIONS AND WEIGHTS

Dimensions and weights are nominal and are not to be used for manufacturing purposes, even when tolerances are shown.

### PERFORMANCE DATA

Performance data given in this catalog is provided as a guide for the user in determining suitability and does not constitute a warranty. It may represent the result of OMRON's test conditions, and the users must correlate it to actual application requirements. Actual performance is subject to the OMRON Warranty and Limitations of Liability.

### ERRORS AND OMISSIONS

The information in this document has been carefully checked and is believed to be accurate; however, no responsibility is assumed for clerical, typographical, or proofreading errors, or omissions.

2008.11

In the interest of product improvement, specifications are subject to change without notice.

**OMRON Corporation**  
Industrial Automation Company

<http://www.ia.omron.com/>

(c)Copyright OMRON Corporation 2008 All Right Reserved.

# Mouser Electronics

Authorized Distributor

Click to View Pricing, Inventory, Delivery & Lifecycle Information:

Omron:

[E6B2-CWZ6C 1000P/R 0.5M](#)