



# LTH3MM12V Series

## 3mm (T-1) Through Hole LED

### Built-in Resistor for 12VDC



#### LTH3MM12VFR4500 - Green Water-Clear T-1 (3 mm) LED

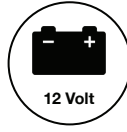

### Applications

- Automotive
- Indoor and Outdoor Indication
- Industrial
- Appliances and Consumer Equipments
- Storage Servers
- Boats
- Railway
- Electronic Devices
- Residential and Landscape Lighting
- Infrastructure

### Key Features

- Made with InGaN (Green)
- Through-hole technology
- Integrated resistor for 12VDC operation
- With Flange
- Water-Clear Lens
- LED Bulb Size: 3mm (T-1), also available in 5mm (T-1 3/4)
- RoHS and REACH Compliant
- High-Brightness LED
- Available in 5 colors (red, green, white, blue and yellow)
- Viewing Angle: 30° (red, green, blue, yellow) and 35° (white)
- Moisture Sensitive Level (MSL): 2

## Ordering Data

The LTH3MM12V Series is available in a range of standard features and options. To specify your LED, simply choose one option from each column.

Series	Mounting Type	Size	Voltage	Flanged	Shape	Lens Color	Output Color LED										
L	TH	3MM	12V	F	R	4											
LED	Through-Hole	3MM 5MM*	12VDC	With Flange	Round Top Water Clear	4	<table border="1"> <tr><td>Red</td><td>100</td></tr> <tr><td>White</td><td>400</td></tr> <tr><td>Green</td><td>500</td></tr> <tr><td>Blue</td><td>600</td></tr> <tr><td>Yellow</td><td>700</td></tr> </table>	Red	100	White	400	Green	500	Blue	600	Yellow	700
Red	100																
White	400																
Green	500																
Blue	600																
Yellow	700																

Part Numbers	Color
LTH3MM12VFR4100	Red
LTH3MM12VFR4400	White
LTH3MM12VFR4500	Green
LTH3MM12VFR4600	Blue
LTH3MM12VFR4700	Yellow

\*For 5mm option, please consult LTH5MM12V Series' datasheet

## Product Dimensions

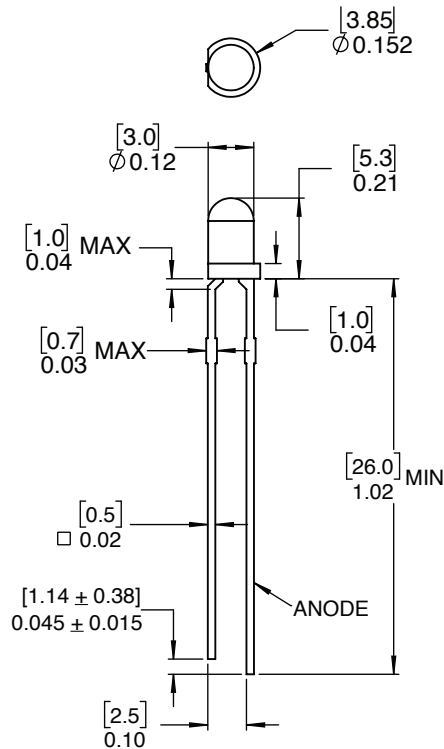

### Notes:

1. All dimensions are in [millimeters] inches
2. Tolerance is  $\pm[0.25]$  0.01 unless otherwise noted.
3. The specifications, characteristics and technical data described in the datasheet are subject to change without prior notice

## Product Dimensions

### ABSOLUTE MAXIMUM RATINGS

(Ta=25°C)

Parameter	Symbol	Ratings	Unit
Peak Forward Current (duty 1/10 @ 1KHz)	I <sub>FP</sub>	100	mA
Recommended Operating Current	I <sub>F(REC)</sub>	20	mA
Power Dissipation	P <sub>D</sub>	85	mW
Reverse Voltage	V <sub>R</sub>	5	V
Electrostatic Discharge	ESD	200	V
Operating Temperature Range	T <sub>OPR</sub>	-40~+85	°C
Storage Temperature Range	T <sub>STG</sub>	-40~+100	°C
Lead Soldering Temperature Range 1.6mm (1/16 inch) from body	T <sub>SOL</sub>	260°C for 5 seconds	

### OPTICAL-ELECTRICAL CHARACTERISTICS

(Ta=25°C)

Parameter	Symbol	Test Condition	Min	Typ	Max	Unit
Luminous Intensity	I <sub>v</sub>	I <sub>F</sub> =10mA	3500	5000	7500	mcd
Peak Emission Wavelength	λ <sub>P</sub>		--	522	--	nm
Dominant Wavelength	λ <sub>D</sub>		--	522	--	nm
Forward Voltage	V <sub>F</sub>		10	12	13	V
Spectral Line Half-Width	Δλ		--	36	--	nm
Viewing Angle	2θ <sub>1/2</sub>		--	30	--	deg
Reverse Current	I <sub>R</sub>	V <sub>R</sub> =5V	--	--	10	μA

# Product Specifications

## Typical Electrical-Optical Characteristic Curves

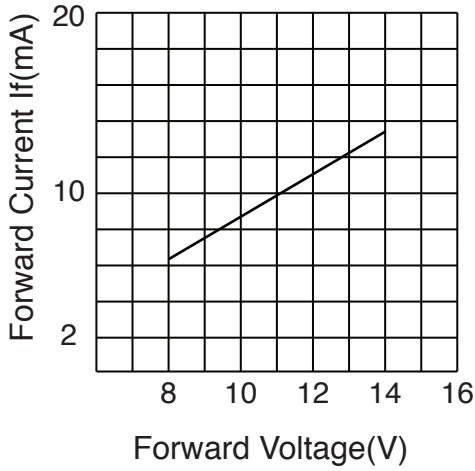

**Forward Current vs. Forward Voltage**

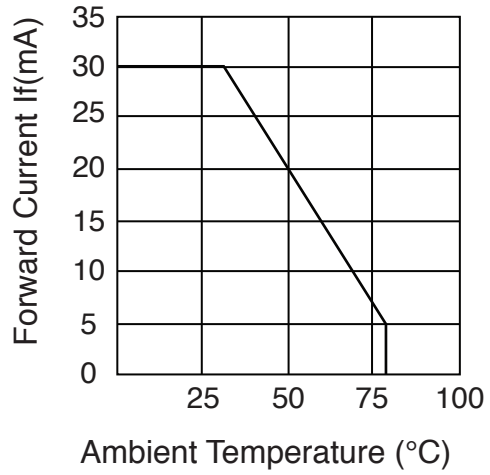

**Forward Current Derating Curve**

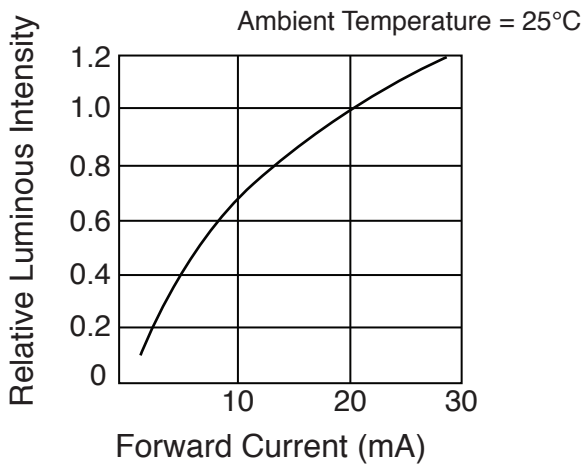

**Luminous Intensity vs. Forward current**

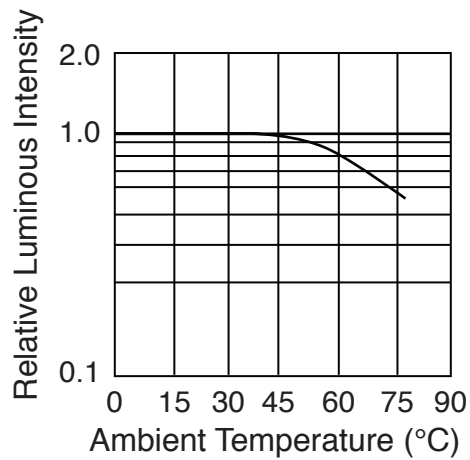

**Luminous Intensity vs. Ambient Temperature**

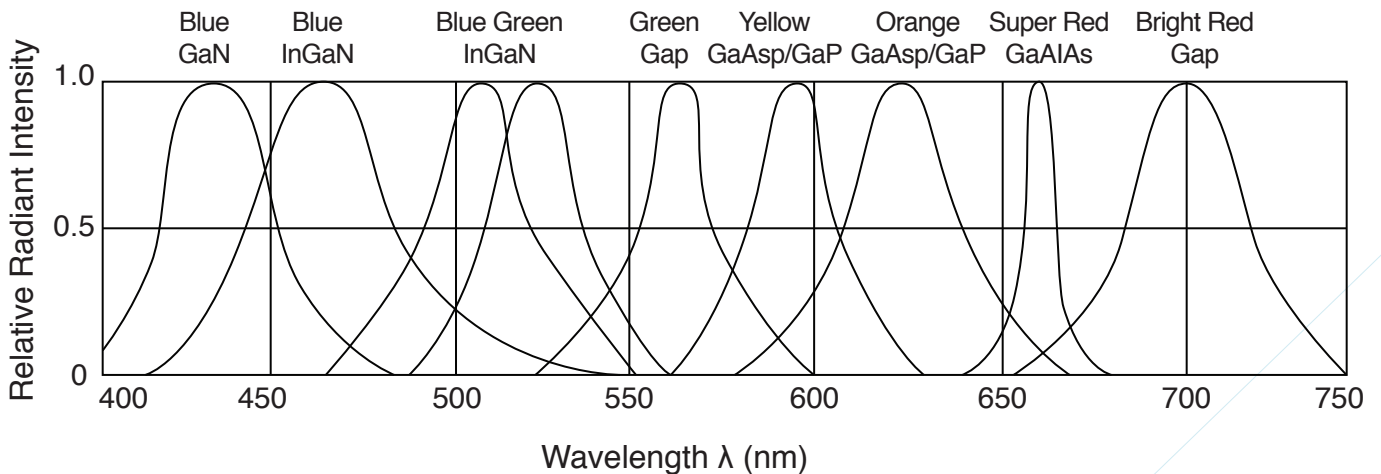

**Relative Intensity vs. Wavelength**

## Application Notes

### 1. Storage

The Storage Temperature and RH are: 5°C ~ 30°C, RH 60% or less.

We suggest our customers use our products within a year.

If the moisture absorbent material (silica gel) has faded away or the LEDs exceeded the storage time, bake treat more than 24 hours at 60°C ±5°C.

### 2. Electrostatic Discharge (ESD)

Static electricity or surge voltage will damage the LEDs.

Recommendations: Use a conductive wrist band or anti-electrostatic glove when handling these LEDs. All devices, equipment and machinery must be properly grounded.

Work tables, storage racks, etc. should be properly grounded. In the event of a manual working in process, make sure the devices are well protected from ESD at any time.

### 3. Recommended Soldering Condition

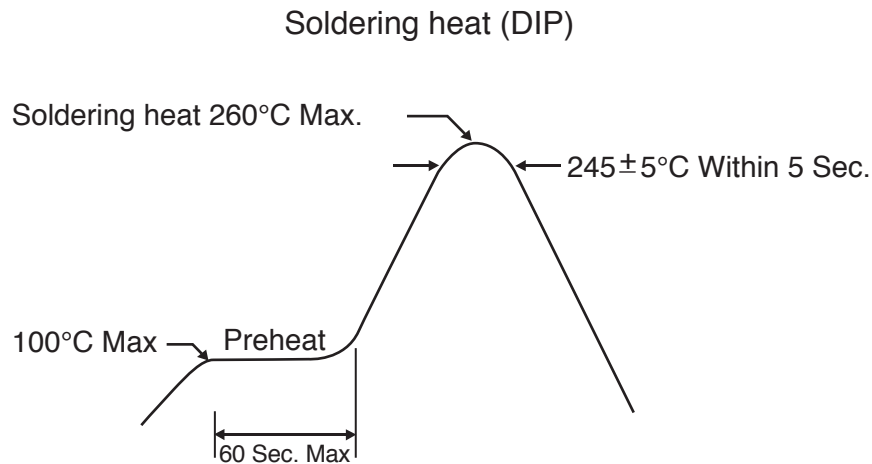

Temperature at tip of soldering iron: 350°C Max

Soldering time: 3 sec ±1 sec (once only)

## Application Notes

### 4. Reflow Profile

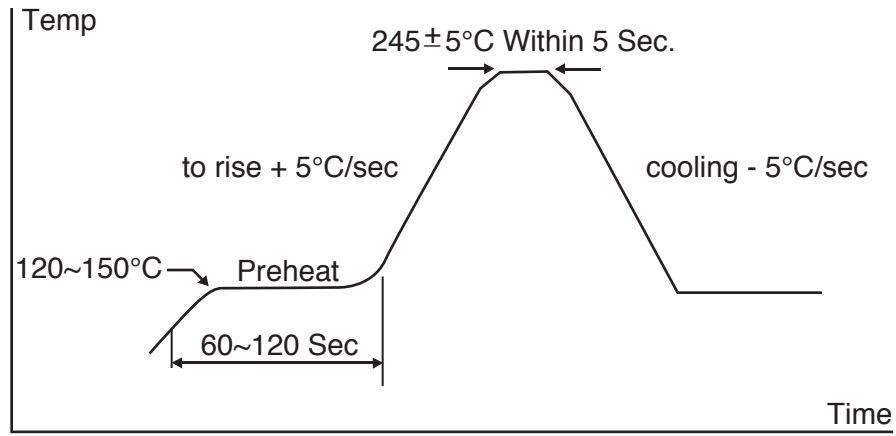

## Compliances and Approvals

