

Product Description

The Qorvo TGP2615-SM is a packaged 6-bit digital phase shifter fabricated on Qorvo's high performance 0.15 um GaAs pHEMT process. It operates over 15 to 19 GHz while providing 360° of phase coverage with a LSB of 5.625°. It also achieves a low RMS phase error of 4°, with 7 dB average insertion loss over all states.

The TGP2615-SM uses positive single-control-line switch logic, eliminating the need for a negative voltage rail or complimentary logic. This, combined with low insertion loss and a high degree of resolution makes the TGP2615-SM ideally suited for applications in phased-array radar and satellite communications.

The device is lead-free and RoHS compliant.

Evaluation Boards are available upon request.

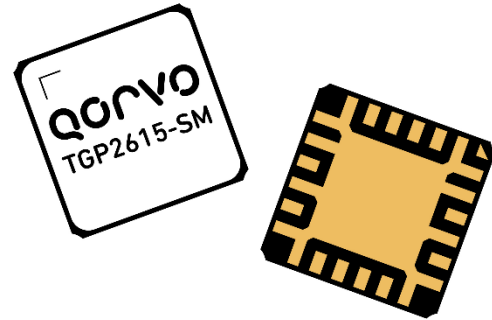

Product Features

- Frequency Range: 15 to 19 GHz
- 6-Bit Digital Phase Shifter
- 360° Coverage, LSB = 5.625°
- RMS Phase Error: 4°
- RMS Amplitude Error: 0.85 dB
- Insertion Loss: 7 dB
- Input Return Loss: >10 dB
- Output Return Loss: >9 dB
- Input P1dB: >23 dBm
- Positive Control Logic: 0 /+3.3 V
- Package Dimensions: 4.0 x 4.0 x 1.45 mm

Performance is typical across frequency. Please reference electrical specification table and data plots for more details.

Block Diagram

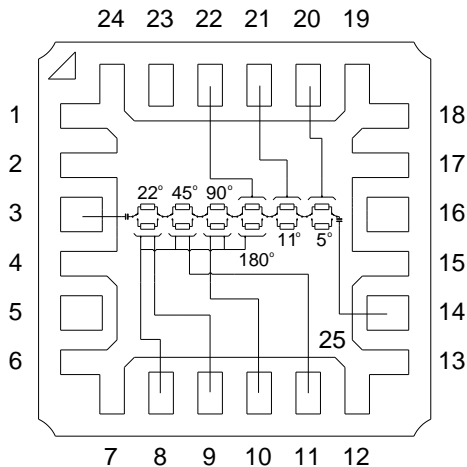

Applications

- Phased-Array Radar
- Satellite Communications

Ordering Information

Part No.	ECCN	Description
TGP2615-SM	EAR99	15-19 GHz 6-Bit Digital Phase Shifter



TGP2615-SM

15-19GHz 6-Bit Digital Phase Shifter

Electrical Specifications

Test conditions unless otherwise noted: 25°C. Control Voltage (REF, 5°, 11°, 22°, 45°, 90°, 180°) = 0/+3.3 V; See Bias Truth Table.

Parameter	Conditions	Min	Typical	Max	Units
Operational Frequency Range		15		19	GHz
Insertion Loss	Average across all phase states		6 - 8		dB
Input Return Loss	Average across all phase states		>10		dB
Output Return Loss	Average across all phase states		>9		dB
RMS Phase Error			4		deg
RMS Amplitude Error			0.85		dB
Input P1dB			>23		dBm
Insertion Loss Temperature Coefficient	Average all phase states, 19 GHz		0.002		dB/°C

Recommended Operating Conditions

Parameter	Value / Range
Control Voltage (5°, 11°, 22°, 45°, 90°, 180°)	0/+3.3 V
Reference Voltage (V _{REF})	+3.3 V
Current (I _{REF} , I _{CTRL})	10 μA
Temperature Range	-40 to +85 °C

Electrical specifications are measured at specified test conditions.
Specifications are not guaranteed over all recommended operating conditions.

Bias Truth Table

Logic "0" = 0 V, Logic "1" = V_{REF} = +3.3 V

Phase Shifter Setting	5°	11°	22°	45°	90°	180°	REF
0° (Reference)	0	0	0	0	0	0	1
5°	1	0	0	0	0	0	1
11°	0	1	0	0	0	0	1
22°	0	0	1	0	0	0	1
45°	0	0	0	1	0	0	1
90°	0	0	0	0	1	0	1
180°	0	0	0	0	0	1	1
355°	1	1	1	1	1	1	1

Performance Plots – Small Signal

Test conditions unless otherwise noted: 3.3 V, 25 °C

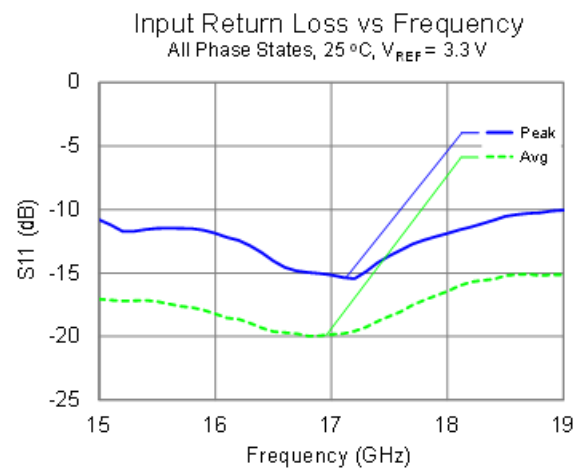
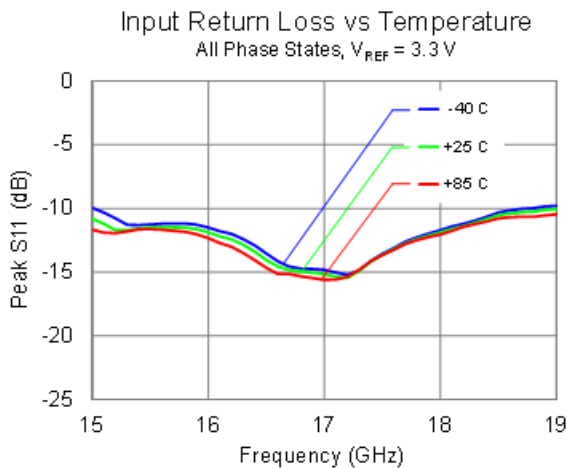
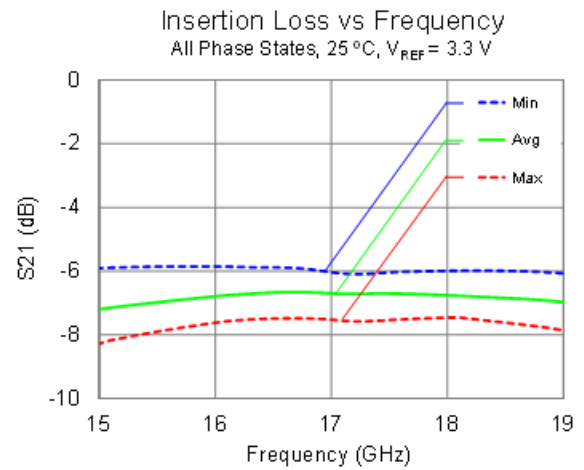
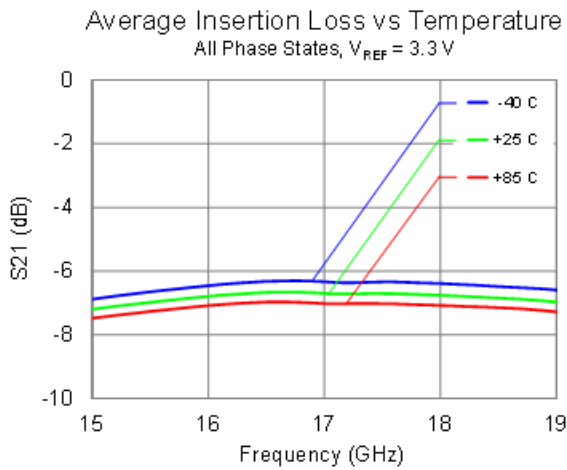
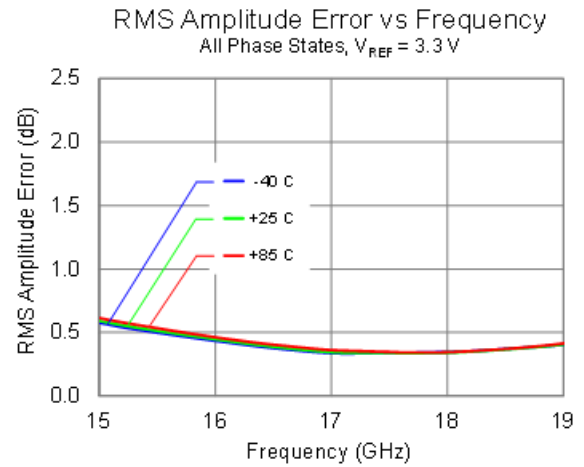
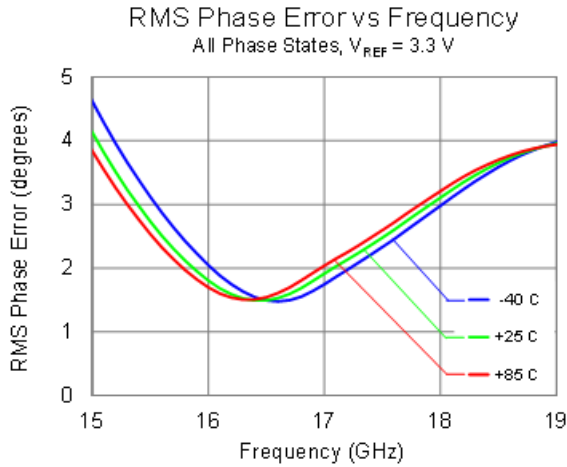

Performance Plots – Small Signal (Cont.)

Test conditions unless otherwise noted: 3.3 V, 25 °C

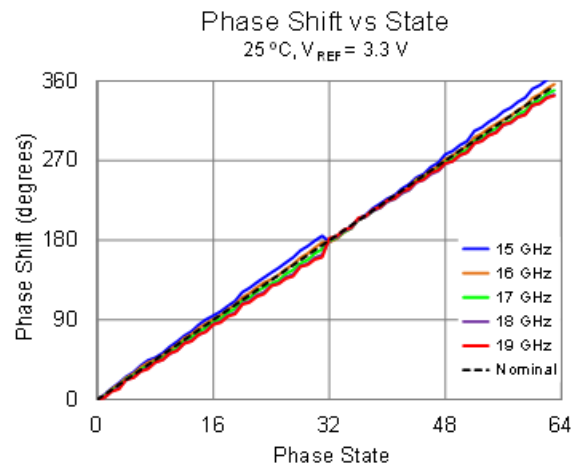
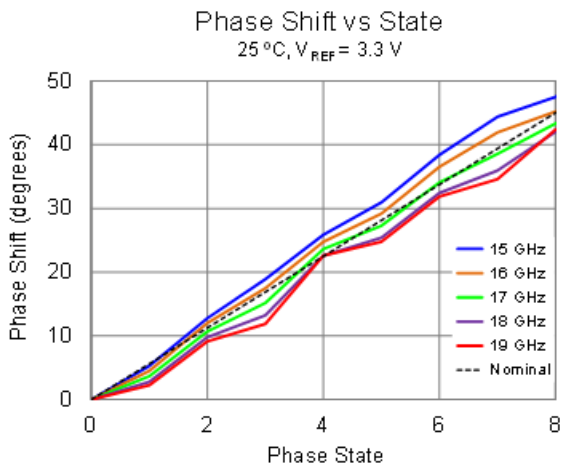
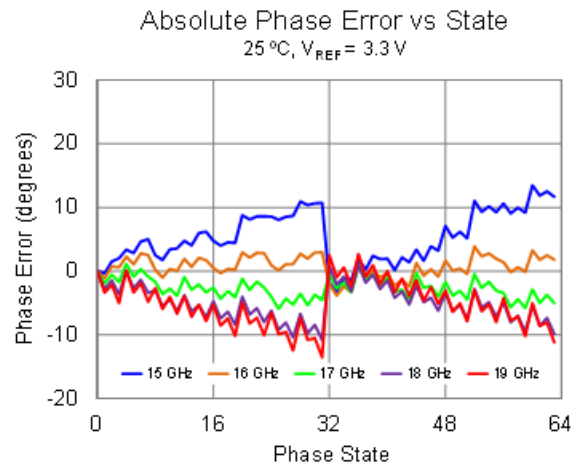
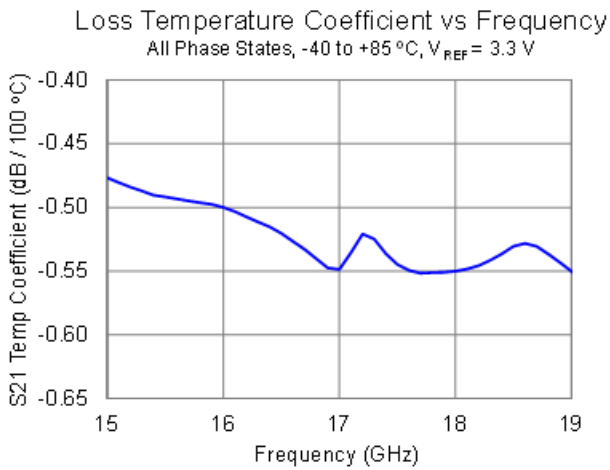
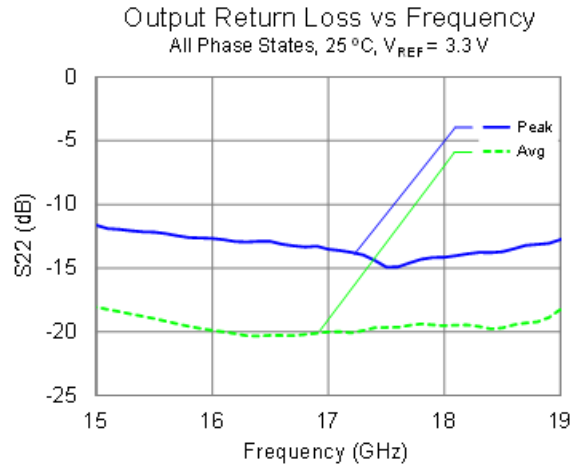
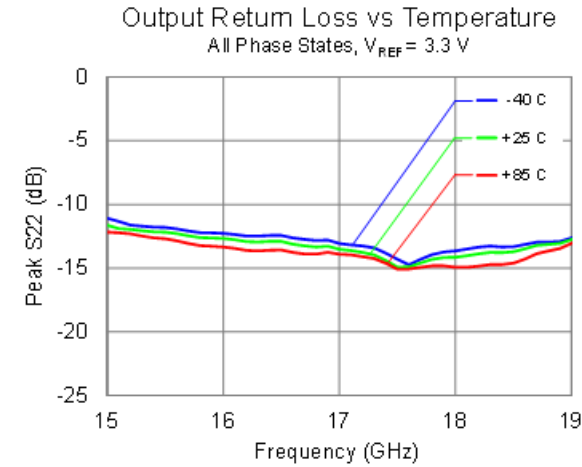

Performance Plots – Large Signal

Test conditions unless otherwise noted: 3.3 V, 25 °C

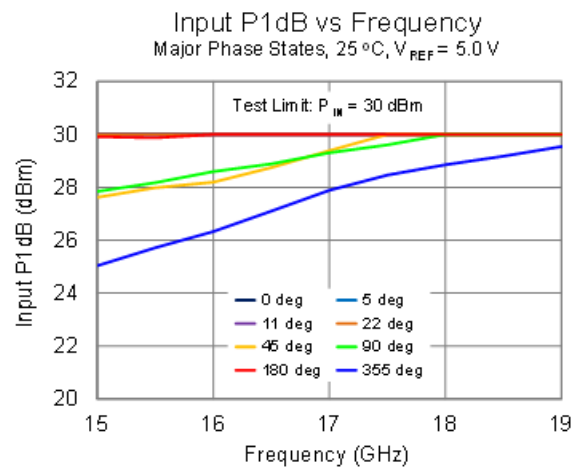
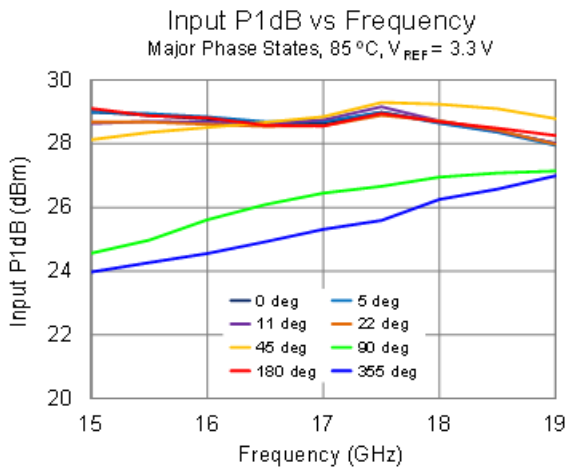
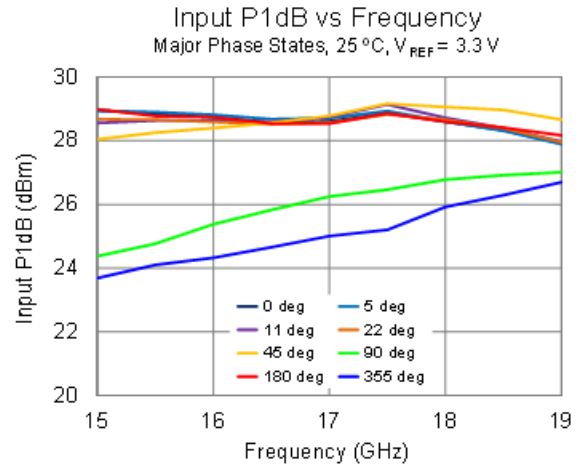
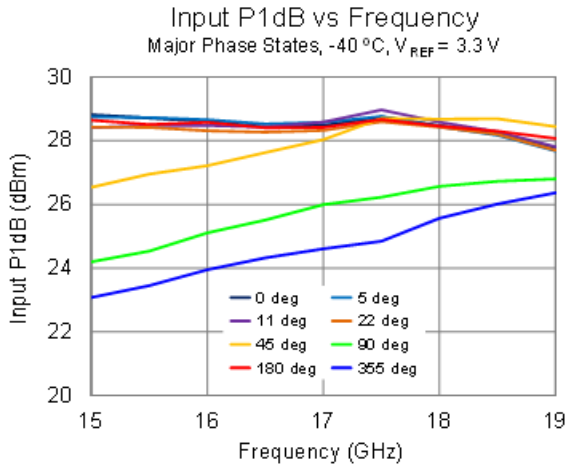

Thermal and Reliability Information

Parameter	Test Conditions	Value	Units
Channel Temperature (T_{CH})	$T_{BASEPLATE} = 85^{\circ}\text{C}$	85	$^{\circ}\text{C}$
Median Lifetime (T_M)		5.2E+9	Hrs

Notes:

- Under normal (lifetime) operating conditions, self-heating is not a significant contributor to channel temperature.

Median Lifetime

Test Conditions: 6.0 V; Failure Criterion = 10% reduction in I_{DQ_MAX}

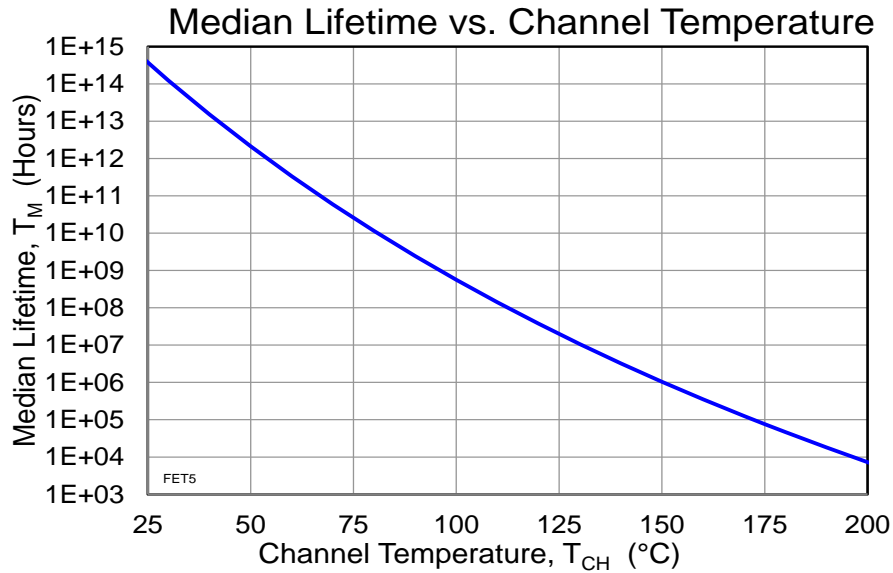

Pin Description

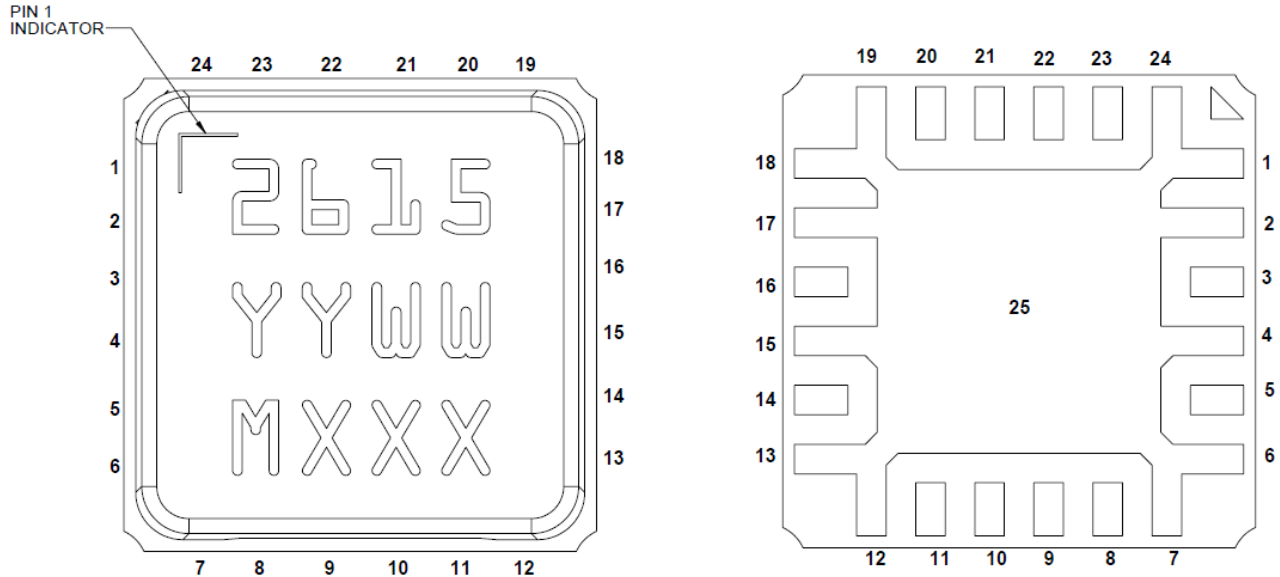

Pin No.	Symbol	Description
1, 2, 4, 6, 7, 12, 13, 15, 17-19, 24	GND	Internal grounding and shielding, must be grounded on PCB
3	RF OUT	RF Output, 50 Ω , DC-Blocked
5, 16, 23	NC	No Connection, Pin Not Used
8	V _{REF}	Reference Voltage for Logic "1" (Nominal 3.3 V)
9	22°	22° Bit Control
10	90°	90° Bit Control
11	45°	45° Bit Control
14	RF IN	RF Input, 50 Ω , DC-Blocked
20	5°	5° Bit Control
21	11°	11° Bit Control
22	180°	180° Bit Control
25 (Slug)	GND	Backside Paddle; multiple vias should be used on PCB to minimize inductance and thermal resistance

Evaluation Board (EVB) Layout Assembly

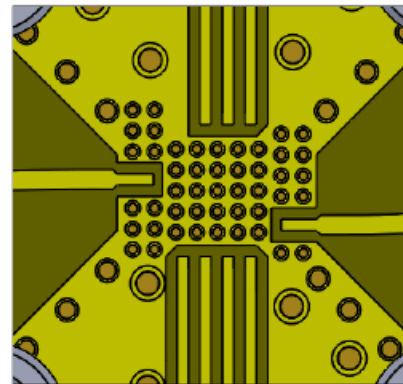
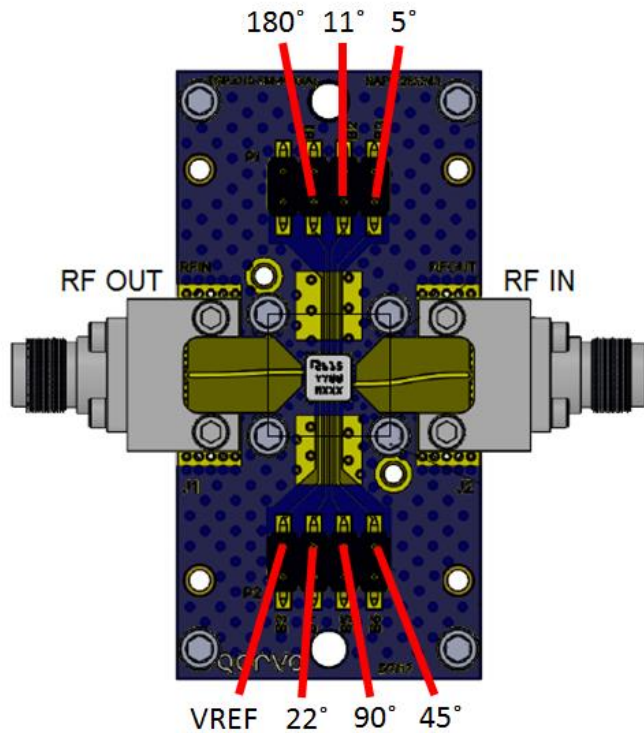

VIA PATTERN

RF layer is 0.008" thick Rogers RO4003C. Metal layers are 0.5-oz copper. Microstrip 50 Ω line width is 0.050". The microstrip line taper at the connector interface is optimized for the Southwest Microwave end-launch connector 1092-01A-5.

Ground / thermal vias under the DUT are critical for the proper performance of this device. The PCB shown herein utilizes copper filled vias (8 mils diameter) under the DUT.

The pad pattern shown has been developed and tested for optimized assembly at Qorvo. The PCB land pattern has been developed to accommodate lead and package tolerances. Since surface mount processes vary from company to company careful process development is recommended.

Mechanical Information

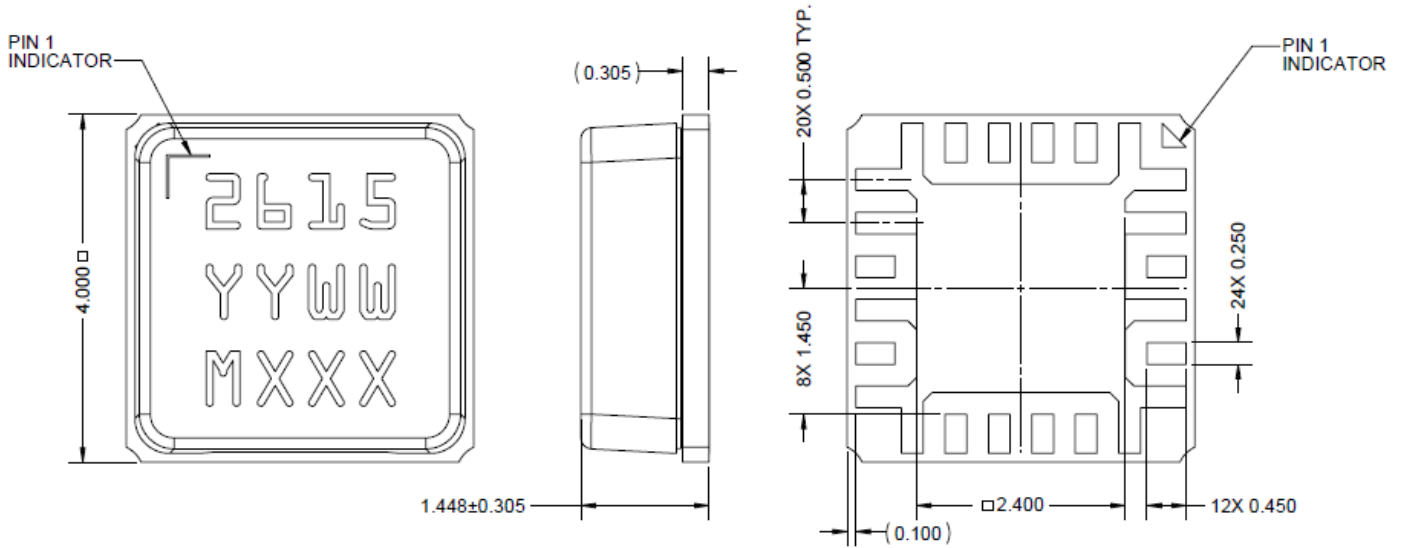

NOTES:

1. PACKAGE BASE: CERAMIC
2. PACKAGE LID: PLASTIC
3. ALL METALIZED FEATURES ARE GOLD PLATED
4. THE PART IS EPOXY SEALED
5. PART MARKING:
 - 2615: PART NUMBER
 - YY: PART ASSEMBLY YEAR
 - WW: PART ASSEMBLY WEEK
 - MXXX: BATCH ID

Absolute Maximum Ratings

Parameter	Value / Range
Control and Reference Voltage	6 V
Control Current	1 mA
Power Dissipation	0.8 W
Input Power, CW, 50 Ω, 85°C	30 dBm
Channel Temperature	200 °C
Mounting Temperature (30 Seconds)	260 °C
Storage Temperature	-55 to 150 °C

Operation of this device outside the parameter ranges given above may cause permanent damage. These are stress ratings only, and functional operation of the device at these conditions is not implied.

Recommended Soldering Temperature Profile

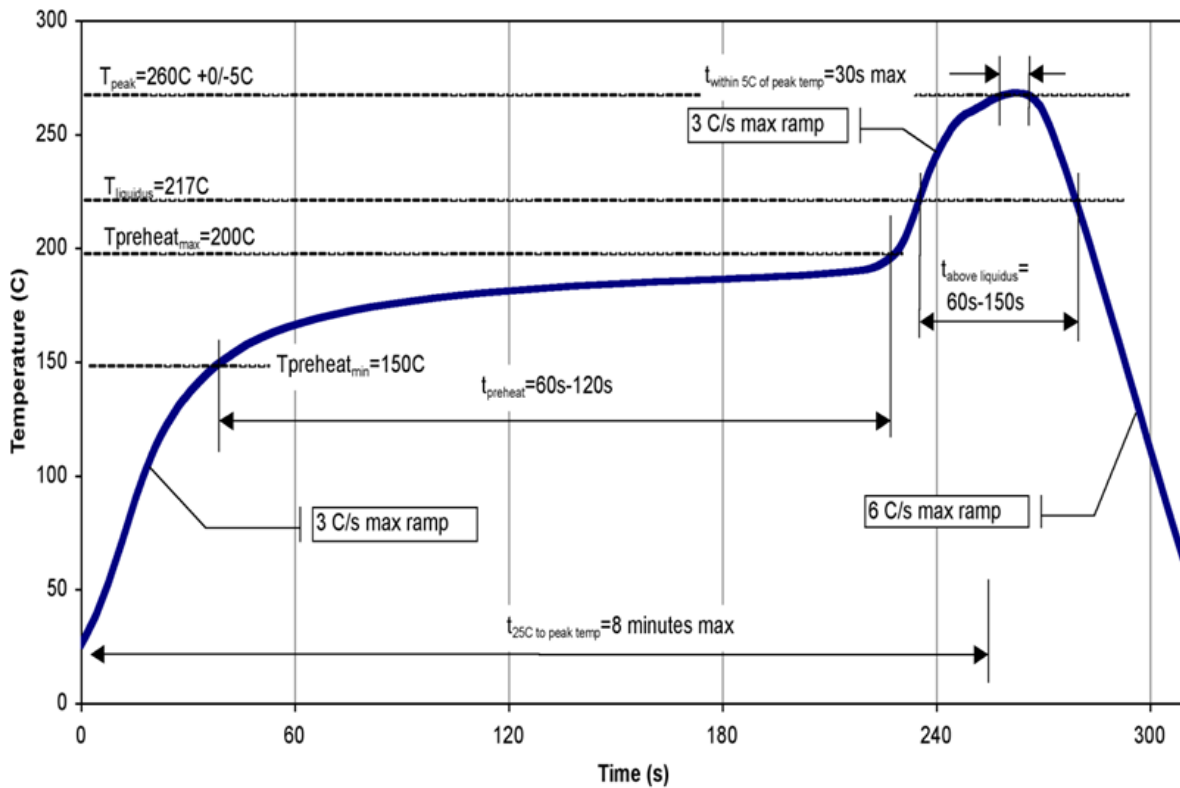

Handling Precautions

Parameter	Rating	Standard
ESD – Human Body Model (HBM)	Class 0B	ESDA / JEDEC JS-001-2014
ESD – Charge Device Model (CDM)	Class C2A	ESDA / JEDEC JS-002-2014
MSL – Moisture Sensitivity Level	MSL 3	IPC/JEDEC J-STD-020



Caution!
ESD-Sensitive Device

Solderability

Compatible with both lead-free (260°C max. reflow temp.) and tin/lead (245°C max. reflow temp.) soldering processes. Solder profiles available upon request.

RoHS Compliance

This product is compliant with the 2011/65/EU RoHS directive (Restrictions on the Use of Certain Hazardous Substances in Electrical and Electronic Equipment), as amended by Directive 2015/863/EU. This product also has the following attributes:

- Lead Free
- Halogen Free (Chlorine, Bromine)
- Antimony Free
- TBBP-A (C₁₅H₁₂Br₄O₂) Free
- PFOS Free
- SVHC Free

Contact Information

For the latest specifications, additional product information, worldwide sales and distribution locations:

Tel: 1-844-890-8163

Web: www.qorvo.com

Email: customer.support@qorvo.com

For technical questions and application information: **Email:** appsupport@qorvo.com

Important Notice

The information contained herein is believed to be reliable; however, Qorvo makes no warranties regarding the information contained herein and assumes no responsibility or liability whatsoever for the use of the information contained herein. All information contained herein is subject to change without notice. Customers should obtain and verify the latest relevant information before placing orders for Qorvo products. The information contained herein or any use of such information does not grant, explicitly or implicitly, to any party any patent rights, licenses, or any other intellectual property rights, whether with regard to such information itself or anything described by such information. **THIS INFORMATION DOES NOT CONSTITUTE A WARRANTY WITH RESPECT TO THE PRODUCTS DESCRIBED HEREIN, AND QORVO HEREBY DISCLAIMS ANY AND ALL WARRANTIES WITH RESPECT TO SUCH PRODUCTS WHETHER EXPRESS OR IMPLIED BY LAW, COURSE OF DEALING, COURSE OF PERFORMANCE, USAGE OF TRADE OR OTHERWISE, INCLUDING THE IMPLIED WARRANTIES OF MERCHANTABILITY AND FITNESS FOR A PARTICULAR PURPOSE.**

Without limiting the generality of the foregoing, Qorvo products are not warranted or authorized for use as critical components in medical, life-saving, or life-sustaining applications, or other applications where a failure would reasonably be expected to cause severe personal injury or death.

Copyright 2017 © Qorvo, Inc. | Qorvo is a registered trademark of Qorvo, Inc.