

## Standard SMD LED PLCC-2



19225

### FEATURES

- High efficient InGaN technology
- Chromaticity coordinate categorized according to CIE1931 per packing unit
- Typical color temperature 5500 K
- EIA and ICE standard package
- Compatible with reflow, vapor phase and wave solder processes acc. to CECC 00802 and J-STD-020C
- Available in 8 mm tape reel
- Lead (Pb)-free device
- Preconditioning: according to JEDEC level 2a
- Component in accordance to RoHS 2002/95/EC and WEEE 2002/96/EC
- ESD-withstand voltage: up to 2 kV according to JESD22-A114-B
- Automotive qualified AEC-Q101



### DESCRIPTION

This device has been designed to meet the increasing demand for white SMD LED.

The package of the VLMW41.. is the PLCC-2.

It consists of a lead frame which is embedded in a white thermoplast. The reflector inside this package is filled with a mixture of epoxy and TAG phosphor.

The TAG phosphor converts the blue emission partially to yellow, which mixes with the remaining blue to give white.

### PRODUCT GROUP AND PACKAGE DATA

- Product group: LED
- Package: SMD PLCC-2
- Product series: standard
- Angle of half intensity:  $\pm 60^\circ$

### APPLICATIONS

- Camera flash light
- Signal and symbol luminaire
- Marker lights
- Interior and exterior automotive lighting: brake lights, turn lights, backlighting, side markers
- Indicator lighting

### PARTS TABLE

PART	COLOR, LUMINOUS INTENSITY	TECHNOLOGY
VLMW41R2S2-5K8L-08	White, $I_V = (140 \text{ to } 280) \text{ mcd}$	InGaN/TAG on Sapphire
VLMW41R2S2-5K8L-18	White, $I_V = (140 \text{ to } 280) \text{ mcd}$	InGaN/TAG on Sapphire
VLMW41S1T1-5K8L-08	White, $I_V = (180 \text{ to } 355) \text{ mcd}$	InGaN/TAG on Sapphire
VLMW41S1T1-5K8L-18	White, $I_V = (180 \text{ to } 355) \text{ mcd}$	InGaN/TAG on Sapphire
VLMW41R1T1-5K8L-08	White, $I_V = (112 \text{ to } 355) \text{ mcd}$	InGaN/TAG on Sapphire
VLMW41R1T1-5K8L-18	White, $I_V = (112 \text{ to } 355) \text{ mcd}$	InGaN/TAG on Sapphire



ABSOLUTE MAXIMUM RATINGS <sup>1)</sup> VLMW41..				
PARAMETER	TEST CONDITION	SYMBOL	VALUE	UNIT
DC forward current	$T_{amb} \leq 80\text{ }^{\circ}\text{C}$	$I_F$	20	mA
Surge forward current	$t_p \leq 10\text{ }\mu\text{s}$	$I_{FSM}$	0.1	A
Power dissipation		$P_V$	84	mW
Junction temperature		$T_j$	110	$^{\circ}\text{C}$
Storage temperature range		$T_{stg}$	- 40 to + 100	$^{\circ}\text{C}$
Operating temperature range		$T_{amb}$	- 40 to + 100	$^{\circ}\text{C}$
Thermal resistance junction/ambient	mounted on PC board (pad size > 16 mm <sup>2</sup> )	$R_{thJA}$	360	K/W

Note:

<sup>1)</sup>  $T_{amb} = 25\text{ }^{\circ}\text{C}$ , unless otherwise specified

OPTICAL AND ELECTRICAL CHARACTERISTICS <sup>1)</sup> VLMW41.., WHITE							
PARAMETER	TEST CONDITION	PART	SYMBOL	MIN	TYP.	MAX	UNIT
Luminous intensity	$I_F = 10\text{ mA}$	VLMW41R2S2	$I_V$	140		280	mcd
		VLMW41S1T1	$I_V$	180		355	mcd
		VLMW41R1T1	$I_V$	112		355	mcd
Chromaticity coordinate x acc. to CIE 1931	$I_F = 10\text{ mA}$	VLMW4100	x		0.33		
Chromaticity coordinate y acc. to CIE 1931	$I_F = 10\text{ mA}$	VLMW4100	y		0.33		
Angle of half intensity	$I_F = 10\text{ mA}$		$\varphi$		$\pm 60$		deg
Forward voltage	$I_F = 20\text{ mA}$		$V_F$		3.3	4.2	V
Temperature coefficient of $V_F$	$I_F = 10\text{ mA}$		$TC_{VF}$		- 3		mV/K
Temperature coefficient of $I_V$	$I_F = 10\text{ mA}$		$TC_{IV}$		- 0.4		%/K

Note:

Not designed for reverse operation

<sup>1)</sup>  $T_{amb} = 25\text{ }^{\circ}\text{C}$ , unless otherwise specified

LUMINOUS INTENSITY CLASSIFICATION				
GROUP	LIGHT INTENSITY (MCD)			
	STANDARD	OPTIONAL	MIN	MAX
R	1	112	140	
	2	140	180	
S	1	180	224	
	2	224	280	
T	1	280	355	

Note:

Luminous intensity is tested at a current pulse duration of 25 ms and an accuracy of  $\pm 11\%$ .

The above type numbers represent the order groups which include only a few brightness groups. Only one group will be shipped on each reel (there will be no mixing of two groups on each reel). In order to ensure availability, single brightness groups are not be orderable.

In a similar manner for colors where wavelength groups are measured and binned, single wavelength groups will be shipped on any one reel.

In order to ensure availability, single wavelength groups are not be orderable.

CROSSING TABLE	
VISHAY	OSRAM
VLMW41..	LWT67C..

CHROMATICITY COORDINATED GROUPS FOR WHITE SMD LED					
	X	Y		X	Y
5L	0.291	0.268	7L	0.330	0.330
	0.285	0.279		0.330	0.347
	0.307	0.312		0.347	0.371
	0.310	0.297		0.345	0.352
5K	0.296	0.259	7K	0.330	0.310
	0.291	0.268		0.330	0.330
	0.310	0.297		0.338	0.342
	0.313	0.284		0.352	0.344
6L	0.310	0.297	8L	0.345	0.352
	0.307	0.312		0.347	0.371
	0.330	0.347		0.367	0.401
	0.330	0.330		0.364	0.380
6K	0.313	0.284	8K	0.352	0.344
	0.310	0.297		0.338	0.342
	0.330	0.330		0.364	0.380
	0.330	0.310		0.360	0.357

Note:

Chromaticity coordinate groups are tested at a current pulse duration of 25 ms and a tolerance of  $\pm 0.01$ .

**TYPICAL CHARACTERISTICS**

$T_{amb} = 25\text{ }^{\circ}\text{C}$ , unless otherwise specified

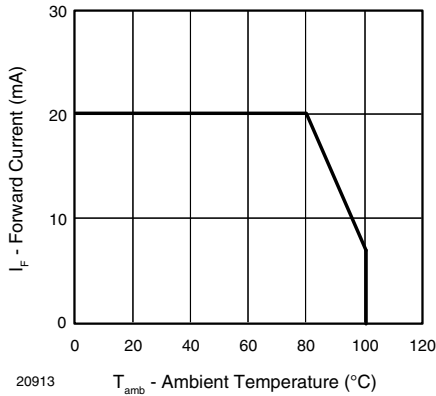

Figure 1. Forward Current vs. Ambient Temperature

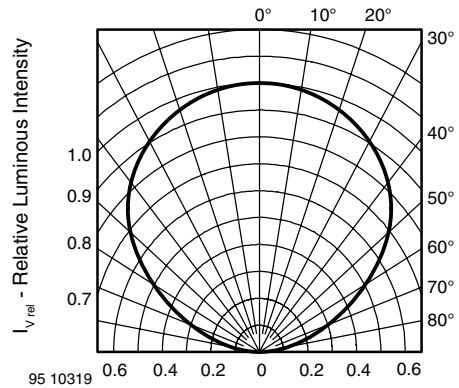

Figure 2. Rel. Luminous Intensity vs. Angular Displacement

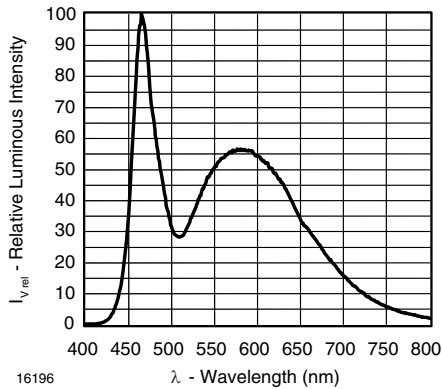

Figure 3. Relative Intensity vs. Wavelength

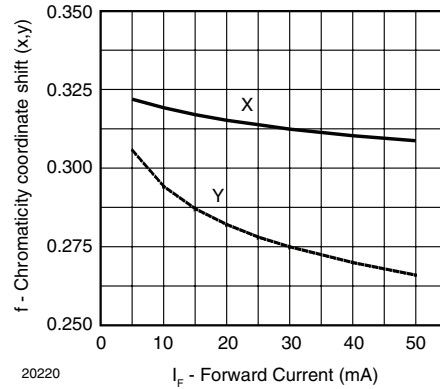

Figure 6. Chromaticity Coordinate Shift vs. Forward Current

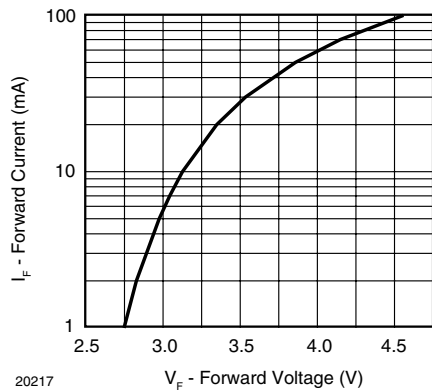

Figure 4. Forward Current vs. Forward Voltage

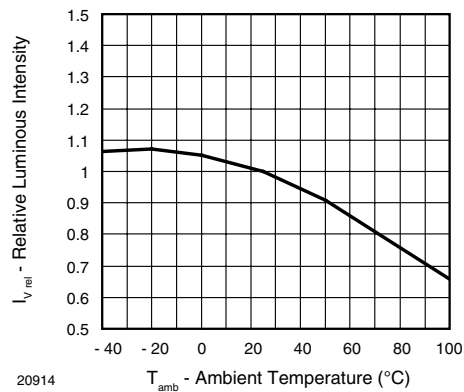

Figure 7. Rel. Luminous Intensity vs. Ambient Temperature

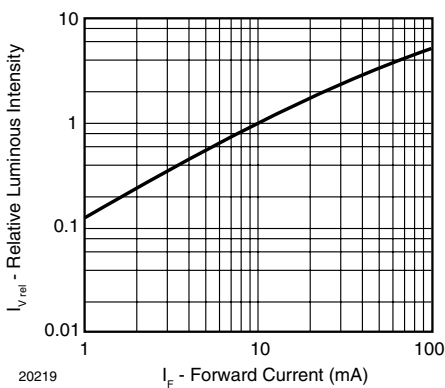

Figure 5. Relative Luminous Intensity vs. Forward Current

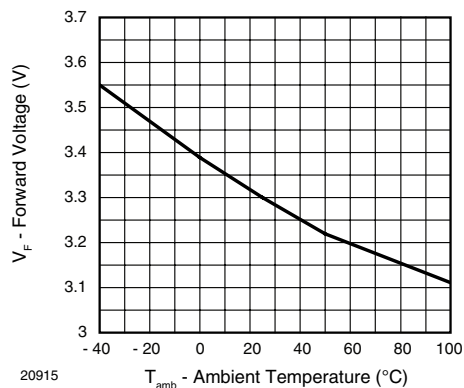

Figure 8. Forward Voltage vs. Ambient Temperature



Figure 9. Coordinates of Colorgroups

**PACKAGE DIMENSIONS** in millimeters



Technical drawings according to DIN specifications



Drawing-No.: 6.541-5067.01-4  
Issue: 4; 30.07.07  
20541



20242

**METHOD OF TAPING/POLARITY AND TAPE AND REEL**

**SMD LED (VLM.3.../.4... - SERIES)**

Vishay's LEDs in SMD packages are available in an antistatic 8 mm blister tape (in accordance with DIN IEC 40 (CO) 564) for automatic component insertion. The blister tape is a plastic strip with impressed component cavities, covered by a top tape.

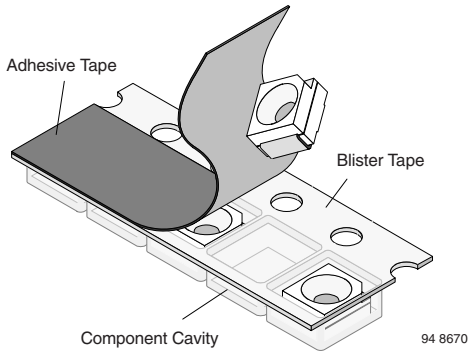

**TAPING OF VLM.3.../.4...**

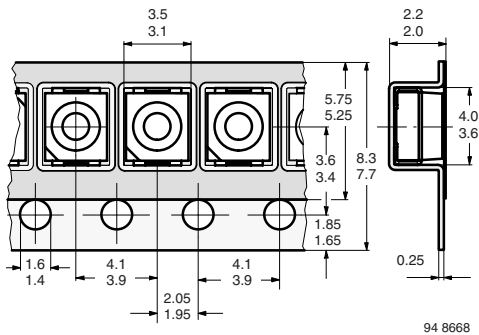

Figure 10. Tape Dimensions in mm for PLCC-2

**REEL PACKAGE DIMENSION IN MM FOR SMD LEDS, TAPE OPTION GS08 (= 1500 PCS.)**



Figure 11. Reel Dimensions - GS08

**REEL PACKAGE DIMENSION IN MM FOR SMD LEDS, TAPE OPTION GS18 (= 8000 PCS.) PREFERRED**



Figure 12. Reel Dimensions - GS18

**SOLDERING PROFILE**

IR Reflow Soldering Profile for Lead (Pb)-free Soldering  
Preconditioning acc. to JEDEC Level 2a



Figure 13. Vishay Lead (Pb)-free Reflow Soldering Profile (acc. to J-STD-020C)

**REEL PACKAGE DIMENSION IN MM FOR SMD LEDS, TAPE OPTION GS08 (= 1500 PCS.)**

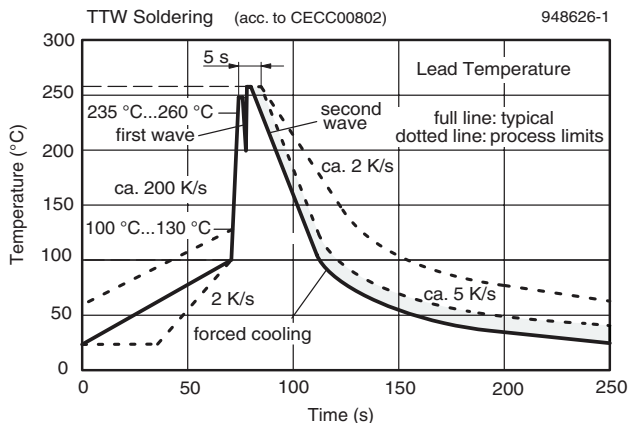
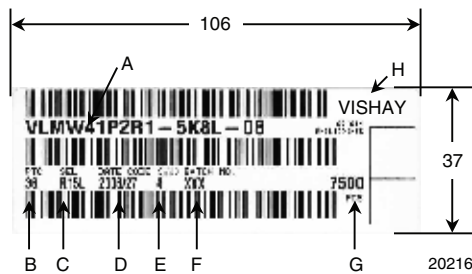

Figure 14. Double Wave Soldering of Opto Devices (all Packages)

**BAR CODE PRODUCT LABEL  
EXAMPLE:**

- A) Type of component
- B) Manufacturing plant
- C) SEL - selection code (bin):  
e.g.: R1 = code for luminous intensity group  
5L = code for chrom. coordinate group
- D) Date code year/week
- E) Day code (e.g. 4: Thursday)
- F) Batch no.
- G) Total quantity
- H) Company code

**DRY PACKING**

The reel is packed in an anti-humidity bag to protect the devices from absorbing moisture during transportation and storage.

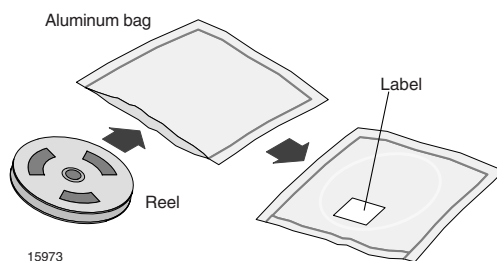
**FINAL PACKING**

The sealed reel is packed into a cardboard box. A secondary cardboard box is used for shipping purposes.

**RECOMMENDED METHOD OF STORAGE**

Dry box storage is recommended as soon as the aluminum bag has been opened to prevent moisture absorption. The following conditions should be observed, if dry boxes are not available:

- Storage temperature 10 °C to 30 °C
- Storage humidity ≤ 60 % RH max.

After more than 672 h under these conditions moisture content will be too high for reflow soldering.

In case of moisture absorption, the devices will recover to the former condition by drying under the following condition:

192 h at 40 °C + 5 °C/- 0 °C and < 5 % RH (dry air/nitrogen) or

96 h at 60 °C + 5 °C and < 5 % RH for all device containers or

24 h at 100 °C + 5 °C not suitable for reel or tubes.

An EIA JEDEC standard JESD22-A112 level 2a label is included on all dry bags.

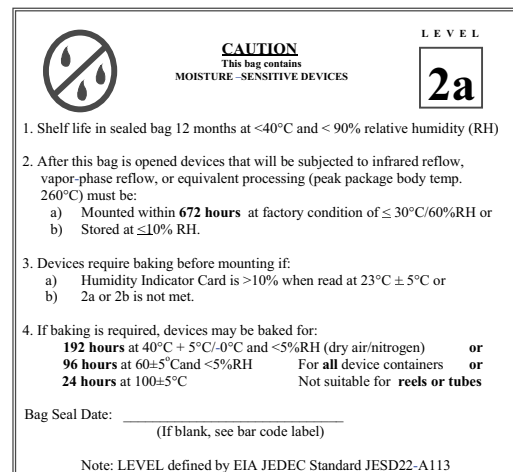

Example of JESD22-A112 level 2a label

**ESD PRECAUTION**

Proper storage and handling procedures should be followed to prevent ESD damage to the devices especially when they are removed from the antistatic shielding bag. Electro-static sensitive devices warning labels are on the packaging.

**VISHAY SEMICONDUCTORS STANDARD  
BAR CODE LABELS**

The Vishay Semiconductors standard bar code labels are printed at final packing areas. The labels are on each packing unit and contain Vishay Semiconductors specific data.

**OZONE DEPLETING SUBSTANCES POLICY STATEMENT**

It is the policy of Vishay Semiconductor GmbH to

1. Meet all present and future national and international statutory requirements.
2. Regularly and continuously improve the performance of our products, processes, distribution and operating systems with respect to their impact on the health and safety of our employees and the public, as well as their impact on the environment.

It is particular concern to control or eliminate releases of those substances into the atmosphere which are known as ozone depleting substances (ODSs).

The Montreal Protocol (1987) and its London Amendments (1990) intend to severely restrict the use of ODSs and forbid their use within the next ten years. Various national and international initiatives are pressing for an earlier ban on these substances.

Vishay Semiconductor GmbH has been able to use its policy of continuous improvements to eliminate the use of ODSs listed in the following documents.

1. Annex A, B and list of transitional substances of the Montreal Protocol and the London Amendments respectively
2. Class I and II ozone depleting substances in the Clean Air Act Amendments of 1990 by the Environmental Protection Agency (EPA) in the USA
3. Council Decision 88/540/EEC and 91/690/EEC Annex A, B and C (transitional substances) respectively.

Vishay Semiconductor GmbH can certify that our semiconductors are not manufactured with ozone depleting substances and do not contain such substances.

We reserve the right to make changes to improve technical design  
and may do so without further notice.

Parameters can vary in different applications. All operating parameters must be validated for each customer application by the customer. Should the buyer use Vishay Semiconductors products for any unintended or unauthorized application, the buyer shall indemnify Vishay Semiconductors against all claims, costs, damages, and expenses, arising out of, directly or indirectly, any claim of personal damage, injury or death associated with such unintended or unauthorized use.

Vishay Semiconductor GmbH, P.O.B. 3535, D-74025 Heilbronn, Germany





## Disclaimer

All product specifications and data are subject to change without notice.

Vishay Intertechnology, Inc., its affiliates, agents, and employees, and all persons acting on its or their behalf (collectively, "Vishay"), disclaim any and all liability for any errors, inaccuracies or incompleteness contained herein or in any other disclosure relating to any product.

Vishay disclaims any and all liability arising out of the use or application of any product described herein or of any information provided herein to the maximum extent permitted by law. The product specifications do not expand or otherwise modify Vishay's terms and conditions of purchase, including but not limited to the warranty expressed therein, which apply to these products.

No license, express or implied, by estoppel or otherwise, to any intellectual property rights is granted by this document or by any conduct of Vishay.

The products shown herein are not designed for use in medical, life-saving, or life-sustaining applications unless otherwise expressly indicated. Customers using or selling Vishay products not expressly indicated for use in such applications do so entirely at their own risk and agree to fully indemnify Vishay for any damages arising or resulting from such use or sale. Please contact authorized Vishay personnel to obtain written terms and conditions regarding products designed for such applications.

Product names and markings noted herein may be trademarks of their respective owners.